



Sliding Shutters

Hunter Douglas **Sliding Shutters** blend style and functionality - inside and out. By **providing** building exteriors with a **futuristic look** as well as offering optimal solar effectiveness for **maximum internal comfort**, Sliding Shutters offer a total building solution.

HunterDouglas

SUN CONTROL



Sliding Shutters

Modern tradition

DESIGN FLEXIBILITY

Sliding Shutters from Hunter Douglas give architects many aesthetic options with a broad range of fin types and the choice of 'Slimline' or extra large frames. With manual or motorised options, the system also offers maximum flexibility for adjustment in easy-to-reach as well as out-of-the-way spaces or when overall building management is required. Sliding Shutters are available in fixed or adjustable fins and with an anodised finish or polyester powder coating.

DURABILITY

With long-lasting extruded aluminium profiles and stainless steel fixation materials, our Sliding Shutter main components are built to last. All additional parts are designed and manufactured to meet the highest standards, and result in a durable, reliable and low-maintenance Sun Control System.

EASY INSTALLATION

Hunter Douglas Sliding Shutters allow easy and quick installation with very few tools as standard shutters arrive preassembled. Multiple rail fixtures are available, permitting the rail system to be fixed to either the façade or between floors depending on the project requirements. Once the rail system has been fitted, the top runners slide into the rails and the shutters are positioned and fitted to the runners. End stops are used to mark the end position of the shutter.



LIGHT, HEAT & ENERGY

Because great looks are not enough, Hunter Douglas has developed computer simulation and calculation tools to ensure optimal shading performance. Considering location, building orientation, pre-defined building requirements and local weather data, our project support team can analyse and custom-optimize the Sun Control System for each project.

Hunter Douglas Sliding Shutters provide architects with multiple options to create unique exteriors while maximising solar control and occupant privacy. With three types of frames, five types of fins and a fixed or adjustable System there is a Sliding Shutter to suit any project design.

CONTENT	Page
Slimline System	2
Heavy Duty System	4
Adjustable System	6
Material/Motorisation	8
Design Options	9
Impressions	10
Light, Heat and Energy	11

Innovative Products Make Innovative Projects



HunterDouglas

Slimline System

INTRODUCTION

The Hunter Douglas Slimline System frame has slender extruded aluminium profiles and rounded edges for a slim appearance. Available with five different fin type designs all fixed within the vertical frame profile, so fixation is not visible from the outside.

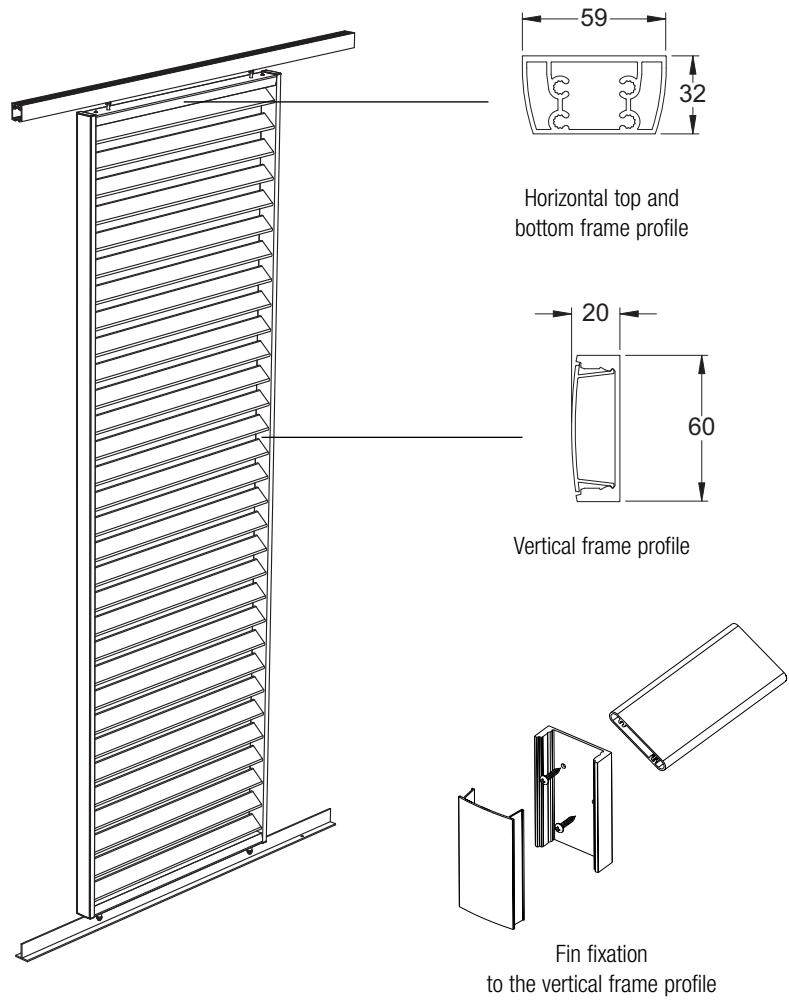

FIN TYPES

Fins compatible with the Slimline System are displayed to the right. Each fin provides the Sliding Shutter with a unique look. Depending on windload, the maximum fin spans may vary.

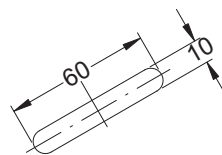

Fin type 1

Material: Aluminium

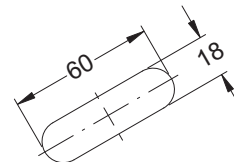

Fin type 2

Material: Aluminium

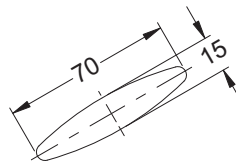

Fin type 3

Material: Aluminium

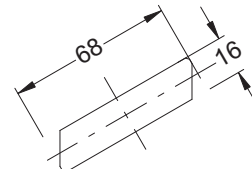

Fin type 5

Material: Western Red Cedar

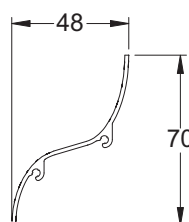

Fin type 6

Material: Aluminium

Slimline System

SHUTTER HEIGHT

The clear height is total height of the Sliding Shutter System including the top rails, bottom rails and the required clearance in-between. Once the clear height has been determined, the 'shutter height' can be calculated.

FIN CONFIGURATIONS

Depending on the required shading performance of the system, several shading angles are possible. This is done by changing the centre to centre distance of the fins.

(See the right picture and the table below.)

Fin type	CTC	Fin Angle	Shading Angle
1	47	40	7
	57	40	20
	70	40	34
2	52	45	7
	60	45	20
	71	45	34
3	60	49	7
	70	49	20
	74	49	34
5	70	30	36
6	76	-	7
	87	-	20
	102	-	34

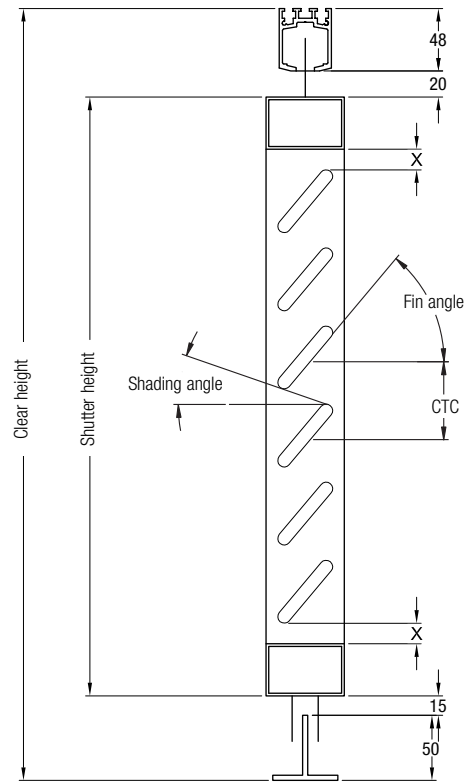

FRAME DIMENSIONS

Frame dimensions -the height and the width- depend on the windloads acting on the shutter.

Two checks need to be made:

1. What shutter height is possible? (depending on windload and shutter width)
2. Is the possible fin span at least the shutter width?

Example (see graph below)

Check 1: Windload: 1.1 kN/m²

Shutter width: 800 mm.

Resulting shutter height: 2940 mm.

Check 2: Fin type: type 6

Resulting fin span: 1280 mm.

Fin span (1280 mm) is greater than shutter width (800 mm.).

Conclusion: Shutter configuration is allowed.

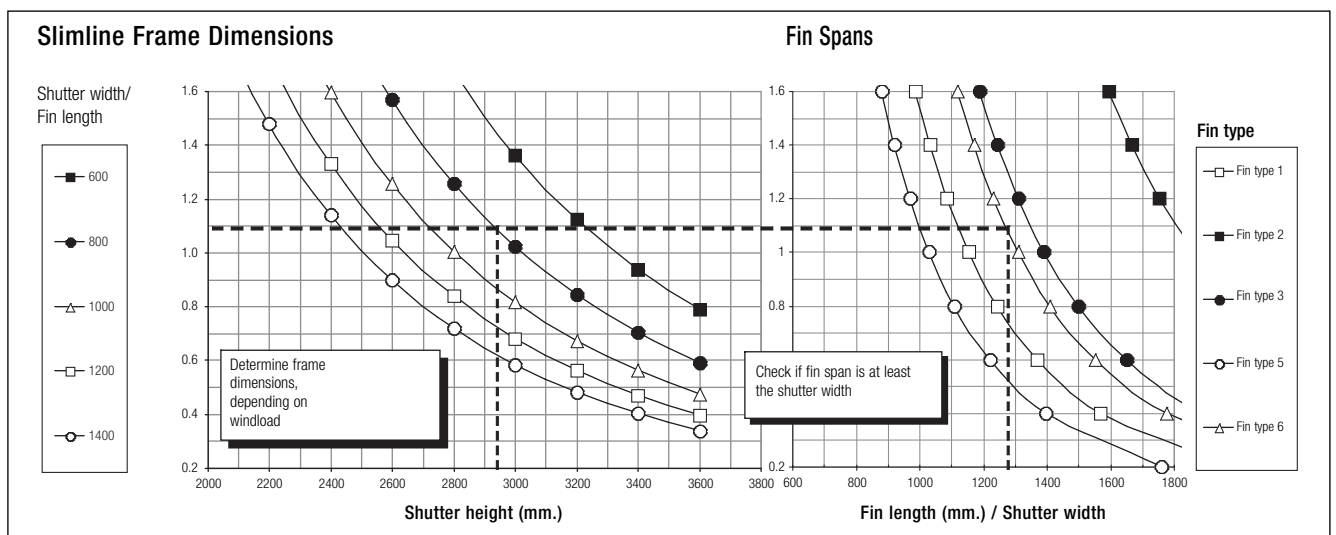

Note: Calculating the value of the local wind load is the responsibility of the installer who must take into account the regulations of local authorities. For corners, roof edges or special designs, wind pressure/suction will be determined with due consideration of the relevant local country's Standard Code of Building Practice.

Heavy Duty System

INTRODUCTION

The frame for the Hunter Douglas Heavy Duty System has strong rectangular extruded aluminium profiles to create a bigger shutter - both in width and height. The Heavy Duty System is available with five different fin type designs all fixed within the vertical frame profile, so fixation is not visible from the outside.

The sturdy frame allows for:

- Steel inserts to create larger shutter dimensions;
- Shutter lock to create an extra safety barrier to protect against unauthorized access (see page 9 for details).

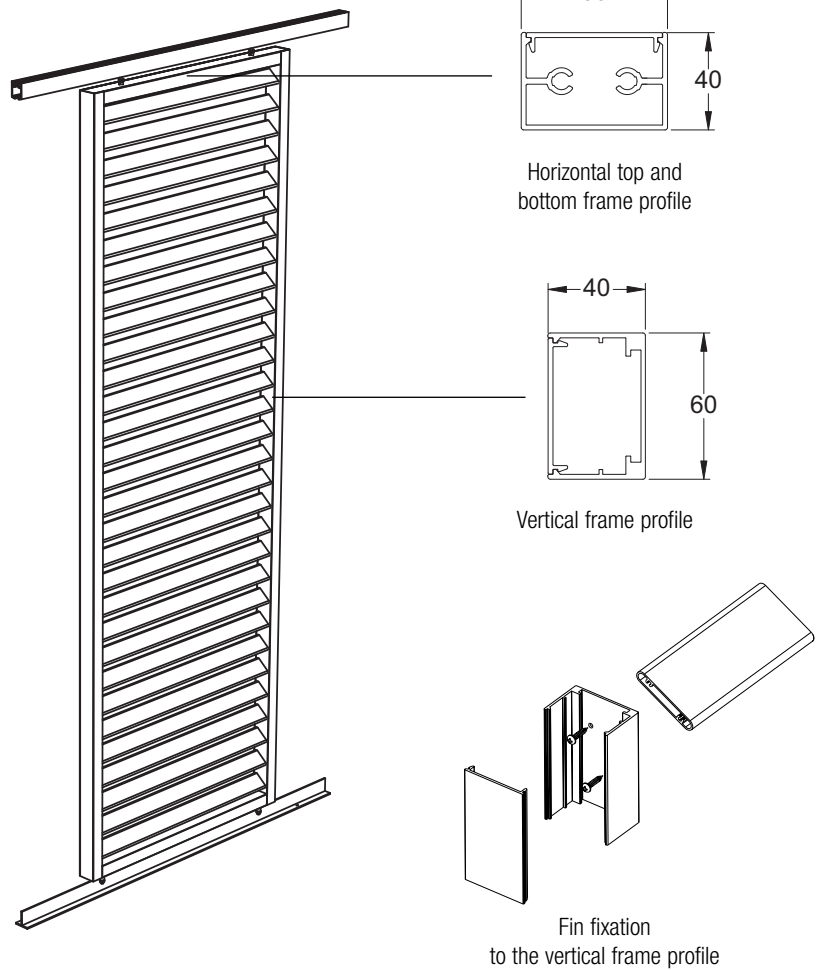

FIN TYPES

The available range of fins in combination with the Heavy Duty System is displayed to the right. Each fin provides the Sliding Shutter with a unique look. Depending on windload, the maximum fin spans may vary.

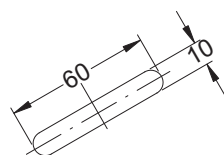

Fin type 1
Material: Aluminium

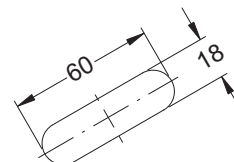

Fin type 2
Material: Aluminium

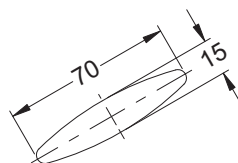

Fin type 3
Material: Aluminium

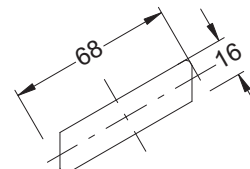

Fin type 5
Material: Western Red Cedar

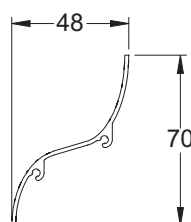

Fin type 6
Material: Aluminium

Heavy Duty System

SHUTTER HEIGHT

The clear height is total height of the Sliding Shutter System including the top rails, bottom rails and the required clearance in-between. Once the clear height has been determined, the 'shutter height' can be calculated.

FIN CONFIGURATIONS

Depending on the required shading performance of the system, several shading angles are possible. This is done by changing the centre to centre distance of the fins.

(See the right picture and the table below.)

Fin type	CTC	Fin Angle	Shading Angle
1	47	40	7
	57	40	20
	70	40	34
2	52	45	7
	60	45	20
	71	45	34
3	60	49	7
	70	49	20
	74	49	34
5	70	30	36
6	76	-	7
	87	-	20
	102	-	34

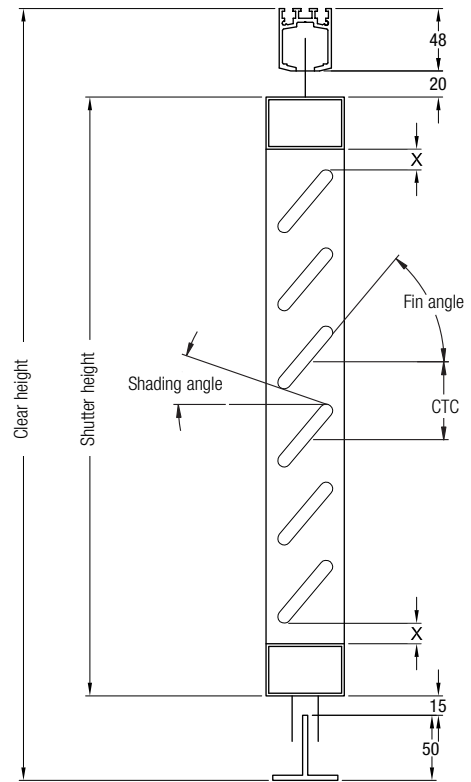

FRAME DIMENSIONS

Frame dimensions -the height and the width- depend on the windloads acting on the shutter.

Two checks need to be made:

1. What shutter height is possible? (depending on windload and shutter width)
2. Is the possible fin span at least the shutter width?

Example (see graph below)

Check 1: Windload: 1.1 kN/m²

Shutter width: 800 mm.

Resulting shutter height: 3250 mm.

Check 2: Fin type: type 6

Resulting fin span: 1280 mm.

Fin span (1280 mm) is greater than shutter width (800 mm.).

Conclusion: Shutter configuration is allowed.

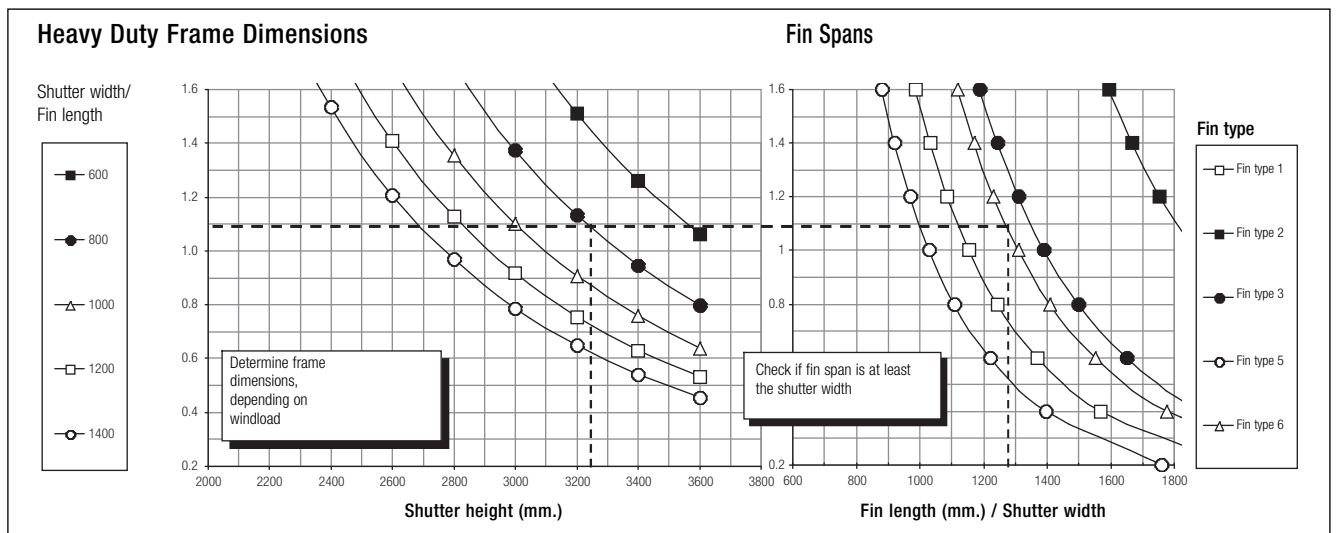

Note: Calculating the value of the local wind load is the responsibility of the installer who must take into account the regulations of local authorities. For corners, roof edges or special designs, wind pressure/suction will be determined with due consideration of the relevant local country's Standard Code of Building Practice.

Adjustable System

INTRODUCTION

The frame for the Hunter Douglas Adjustable System has heavy-duty rectangular extruded aluminium profiles to create a bigger shutter - both in width and height. The horizontal top and bottom frame profiles have extra stiffness to provide stability for the adjustable fins.

The Adjustable System is available with two different fin types.

All fins are connected within the vertical frame profiles and move simultaneously.

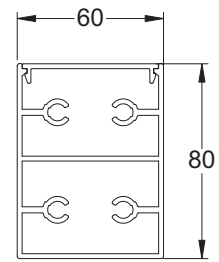
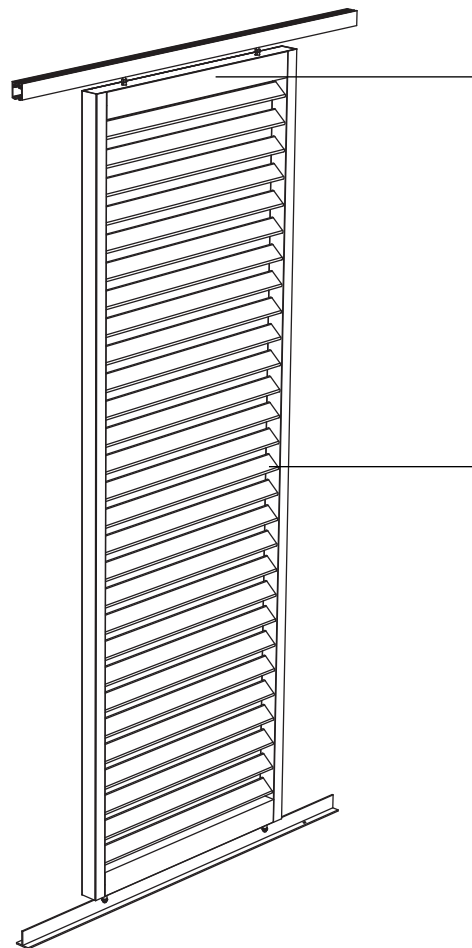

Horizontal top and bottom frame profile

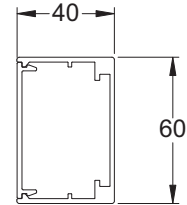

Vertical frame profile

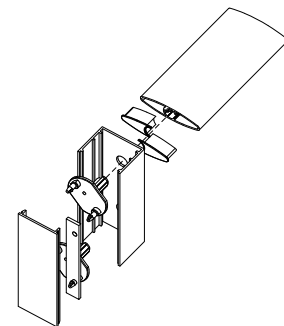

Fin fixation to the vertical frame profile

FIN TYPES

Fins compatible with the Adjustable System are displayed to the right. Each fin provides the Sliding Shutter with a unique look, and depending on windload, the maximum fin spans may vary.

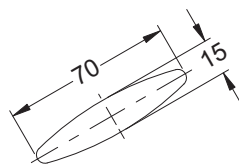

Fin type 4

Material: Aluminium

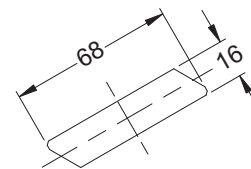

Fin type 5

Material: Western Red Cedar

FIN ROTATION

Each fin is connected to a driving rod to enable simultaneous rotation. The driving rod mechanism is integrated into the vertical frame, maintaining the clean aesthetics of the sliding shutter. The fins are rotated by hand.

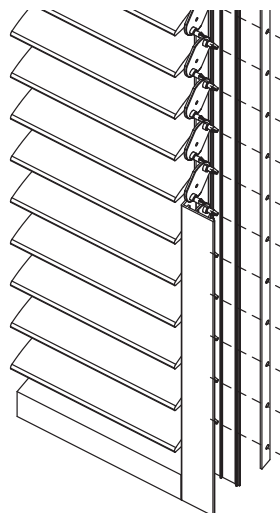

Adjustable System

SHUTTER HEIGHT

The clear height is total height of the Sliding Shutter System including the top rails, bottom rails and the required clearance in-between. Once the clear height has been determined, the 'shutter height' can be calculated.

FIN CONFIGURATIONS

Depending on the required shading performance of the system, several shading angles are possible. This is done by changing the angle of the adjustable fins. (See the right picture and the table below.)

Fin type	CTC	Fin Angle	Solar Angle
4	67	0-90	-
5	67	0-90	-

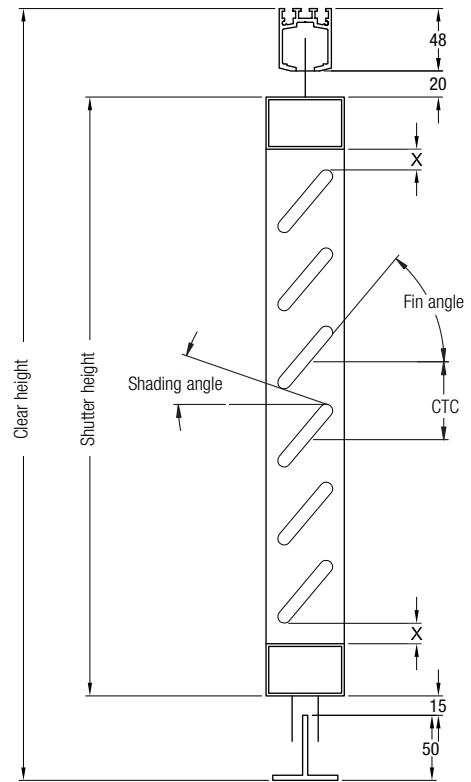

FRAME DIMENSIONS

Frame dimensions -the height and the width- depend on the windloads acting on the shutter.

Two checks need to be made:

1. What shutter height is possible? (depending on windload and shutter width)
2. Is the possible fin span at least the shutter width?

Example (see graph below)

Check 1: Windload: 1.1 kN/m²

Shutter width: 800 mm.

Resulting shutter height: 2510 mm.

Check 2: Fin type: type 4

Resulting fin span: 1350 mm.

Fin span (1350 mm) is greater than shutter width (800 mm.).

Conclusion: Shutter configuration is allowed.

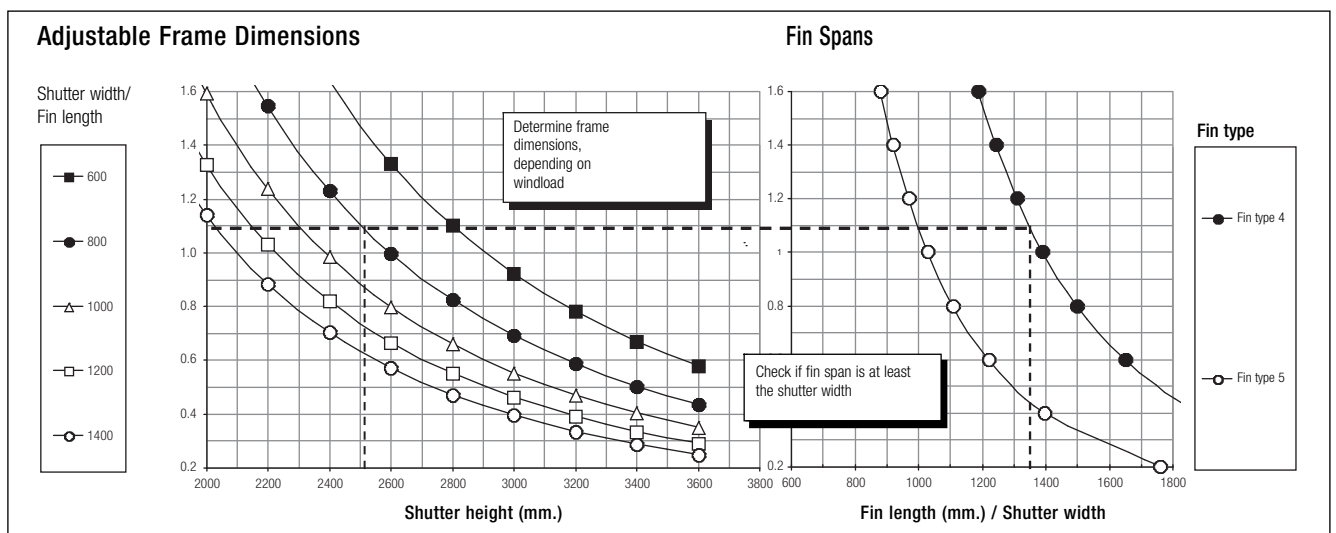

Note: Calculating the value of the local wind load is the responsibility of the installer who must take into account the regulations of local authorities. For corners, roof edges or special designs, wind pressure/suction will be determined with due consideration of the relevant local country's Standard Code of Building Practice.

Material

FRAME

Both horizontal and vertical frame profiles are made of extruded aluminium.

FINS

The aluminium fins are extruded profiles. The wooden fins are Western Red Cedar.

RUNNERS

The top runners have an injection-moulded body. The wheels have ball bearings that allow the shutter to easily slide even after spending many years exposed to the elements. The bottom runners have stainless steel axles and a POM wheel combined with a rubber lining, for extra smooth running of the shutter.

FIXATION MATERIALS

All fixation materials are stainless steel. The adjustable fins are connected to the frame with components made of glass filled nylon.

SURFACE TREATMENT

The aluminium components can either be anodised or powder coated.

ANODISATION

As a standard the components are anodised technically blank according to the European code EN-12373. Layer thickness is approximately 15-20 micron. Different colours and thicknesses available upon request.

POWDER COATING

All aluminium profiles can be coated with polyester powder with an average layer thickness of 60 micron and a gloss of 70%. Powder coating is applied according to the Qualicoat standard. We distinguish three different colour ranges: standard RAL colours, metallic RAL colours and pearl RAL colours. Other colour standards such as NCS and Pantone are possible upon request.

In addition, we can coat our profiles with the new Softcoat Systems for a soft structure look with high scratch resistance and a smooth gloss of 4%.

Motorisation

CONTROL SYSTEMS

The shutter can slide manually or it can be motorised making it possible for the system to function in places where manual positioning is not possible. It also allows for the shutters to become a part of a total building management system which optimises the shading performance of the shutter. Several configurations are possible. See examples below.

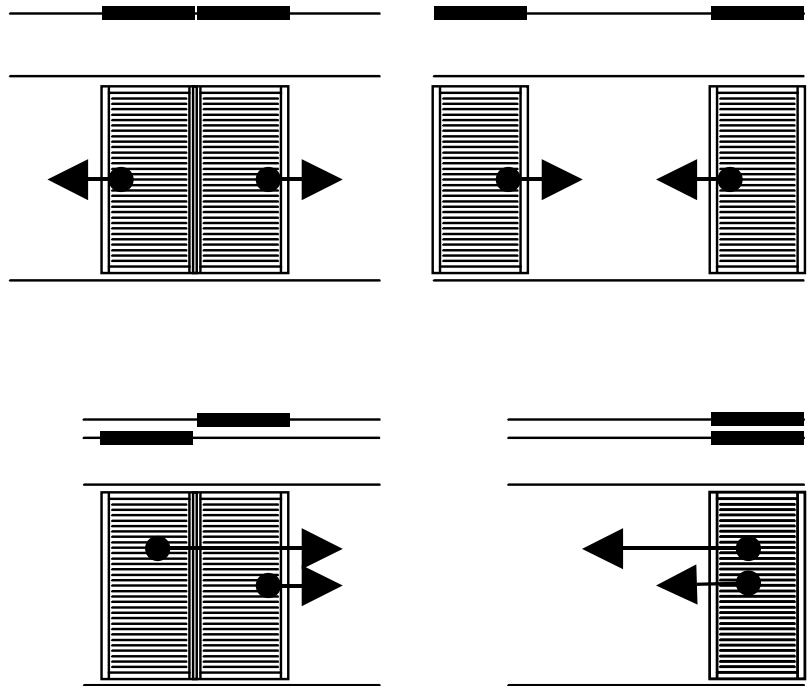

Design Options

FILLING MATERIALS

In addition to the standard fins there is a wide range of other materials available that can be used in combination with the Hunter Douglas Sliding Shutters. Below other options are displayed. Other material options and custom solutions available upon request.

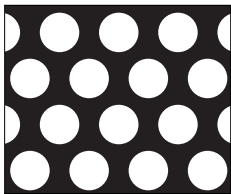

Perforated sheet

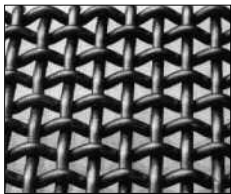

Wire Mesh

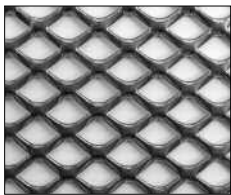

Stretch metal

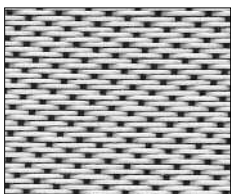

Fibreglass screen fabric



Glass

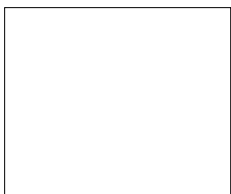

Custom design fin shapes

SLIDING SHUTTER LOCK

A lock in combination with a sliding shutter provides an added protection against unauthorized access. The lock can be used in combination with a variety of cylinders. A standard solution is available for the Heavy Duty System, in combination with fixed fins. Other lock solutions available upon request.

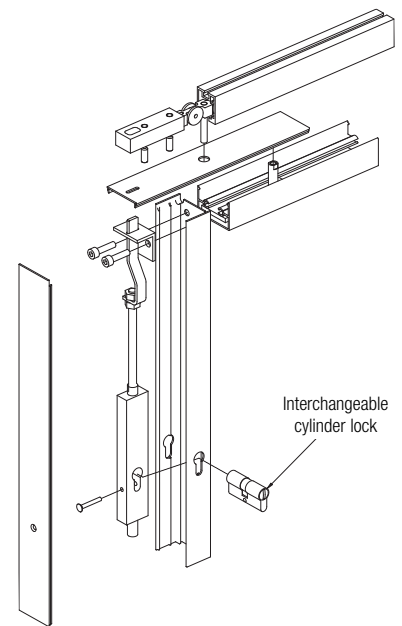

TOP RAILS FIXATION METHODS

The top rails for Sliding Shutters can be easily fixed to the building structure using the following methods. Other solutions available upon request.

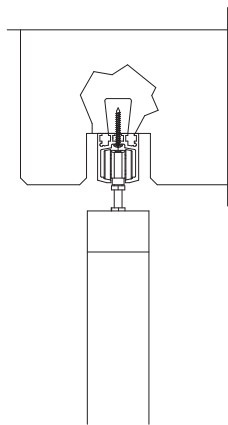

Concealed-fixation

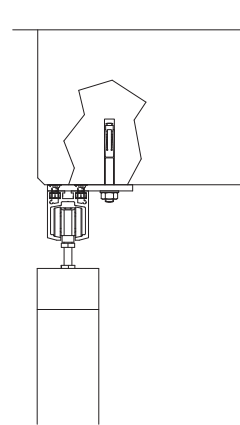

Flush-fixation

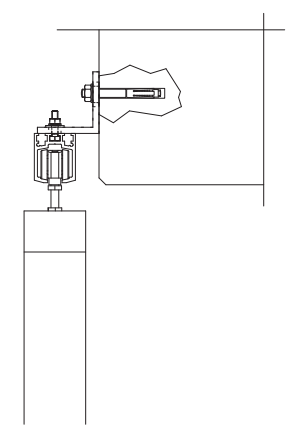

Front-fixation

Impressions

*Project : Residential plan St. Cy
Location : Geldrop, the Netherlands
Special : Oregon Pine + Glass*



*Project : Nieuw Australië - Boston
Location : Amsterdam, the Netherlands*



Light, Heat and Energy

COMFORT AND ENERGY SAVING

Using the right Sun Control System can greatly influence the thermal and visual indoor climate. Using the system intelligently both improves the overall comfort of a room, and minimises energy costs (lighting, heating and cooling installations).

By effectively reducing the amount of solar radiation entering the building with Sun Control Systems, the amount of energy needed to cool the building is immediately decreased. Therefore, the capacity of the cooling equipment can be reduced, resulting in lower initial investments and operational costs.

By either blocking, transmitting, or reflecting direct sunlight and daylight the Hunter Douglas Sun Control Systems make optimal use of this free source of light. By analysing the shading performance optimal daylight levels are achieved and glare kept to a minimum, resulting in a healthy and productive working environment.

LIGHT AND ENERGY TOOL

The Hunter Douglas engineers calculate optimal solar shading solutions using the Hunter Douglas Light and Energy tool. The tool can demonstrate the effects of a range of shading solutions for the building and its occupants. By analysing this data a complete solution can be developed to meet all the specified building performance criteria for a project. The results and recommendations from the Light and Energy Tool presented in a report can be added to the building specifications, ensuring that all criteria are fully met.

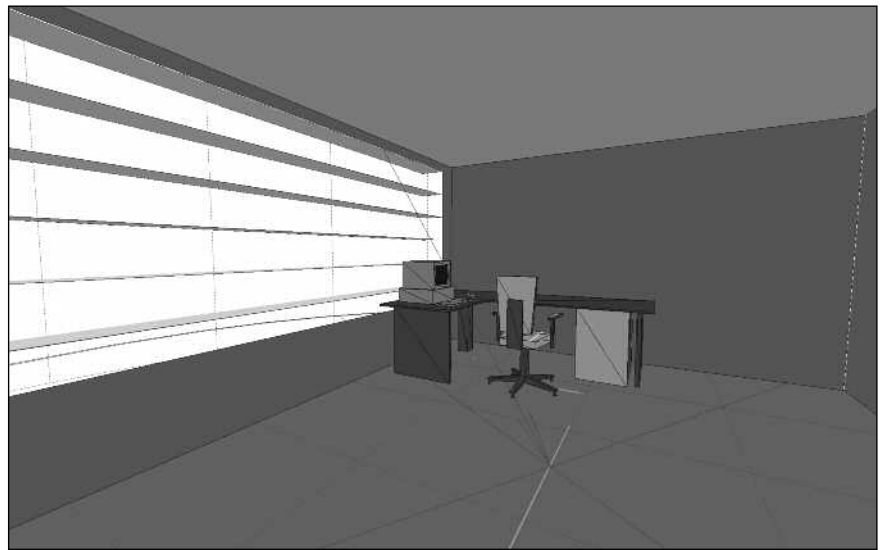

Internal view 12:00 AM, April 1st

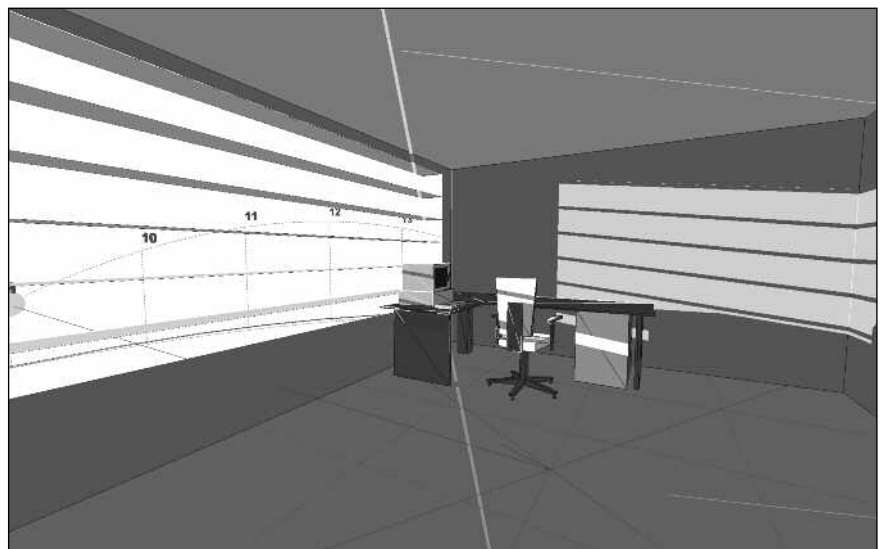

Internal view 9:00 AM, December 1st

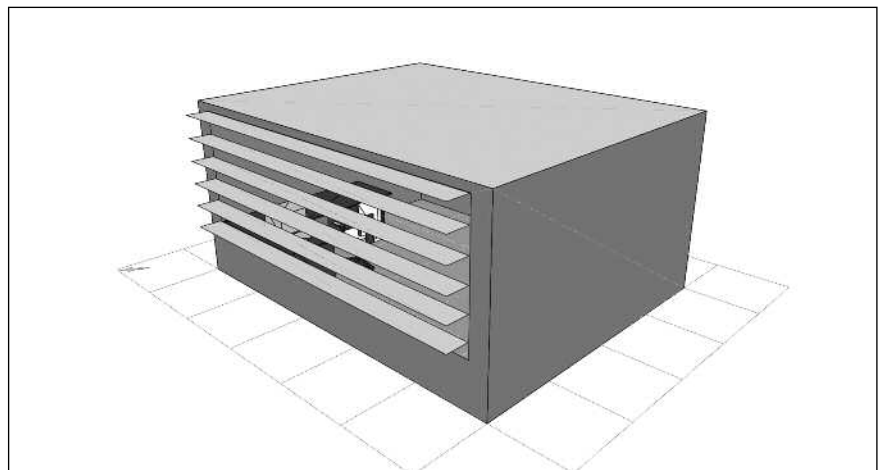

External view 9:00 AM, December 1st



HUNTER DOUGLAS ARCHITECTURAL PRODUCTS

For 80 years, Hunter Douglas has been dedicated to innovation. As the field of Sun Control grows, we pride ourselves on leading the way as pioneers in the area.

We're working alongside architects and designers throughout the globe, developing new, innovative methods of managing heat, light and energy. We've committed ourselves to crafting products that meet the highest standards of materials, construction and performance because we believe that you need the right tools to create projects that inspire.

Innovative Products Make Innovative Projects



Promoting sustainable
forest management
www.pefc.org

© Registered trademark - a HunterDouglas® product Pats. & Pats. Pend. - Technical data subject to change without notice.
© Copyright Hunter Douglas 2008. No rights can be derived from copy, text pertaining to illustrations or samples. Subject to changes in materials, parts, compositions, designs, versions, colours etc., even without notice. **MX080S00**



ARCHITECTURAL SERVICES

We support our business partners with a wide range of technical consulting and support services for architects, developers and installers. We assist architects and developers with recommendations regarding materials, shapes and dimensions, colours and finishes. We also help creating design proposals, visualisations and mounting drawings. Our services to installers range from providing detailed installation drawings and instructions to training installers and advising on the building site.



We are dedicated manufacturing a sustainable product. Our paint and aluminium melting processes are considered to be one of the industry standards in terms of clean production processes. All aluminium products are 100% recyclable at the end of their lifecycle.

HunterDouglas

SUN CONTROL

Learn More

- Contact our Sales office
- www.hunterdouglascontract.com

Aerofoils

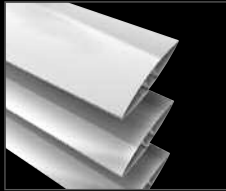

Aerowing



Aeroscreen

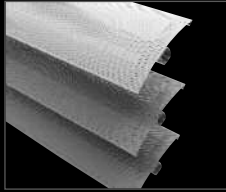

84R/100R

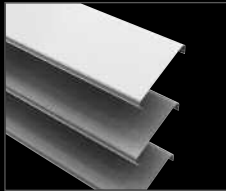

70S/132S

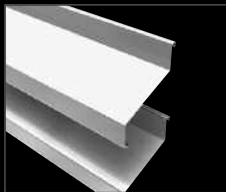

110HC



Shutters



- Austria
- Belgium
- Bulgaria
- Croatia / Slovenia
- Czechia
- Denmark
- France
- Germany
- Greece
- Hungary
- Ireland
- Italy
- Kazakhstan
- the Netherlands
- Norway
- Poland
- Portugal
- Romania
- Russia
- Serbia
- Slovakia
- Spain
- Sweden
- Switzerland
- Turkey
- Ukraine
- United Kingdom
- Africa
- Middle East

- Asia
- Australia
- Latin America
- North America

HUNTER DOUGLAS
CONSTRUCTION ELEMENTS UK
 Keys Park Road, Hednesford,
 Cannock, Staffordshire, WS12 2FR
 Tel. +44 (0)1543 275757
 Fax +44 (0)1543 271414
 info@hdce.co.uk
 www.hunterdouglas.co.uk

HunterDouglas