

Para personalizar el cabezal HOSPITAL deben seguirse las siguientes indicaciones:

- 1- Escoger la iluminación directa.
- 2- Escoger la iluminación indirecta.
- 3- Escoger la iluminación directa adosada al perfil.

4- Indicar los mecanismos opcionales que se necesitan en las posiciones A, B, C y D. Si se necesitan más mecanismos, se pueden realizar longitudes especiales.

Las luminarias se sirven con las opciones de iluminación y los mecanismos escogidos.

También incorpora una fijación a pared de 50 cm.

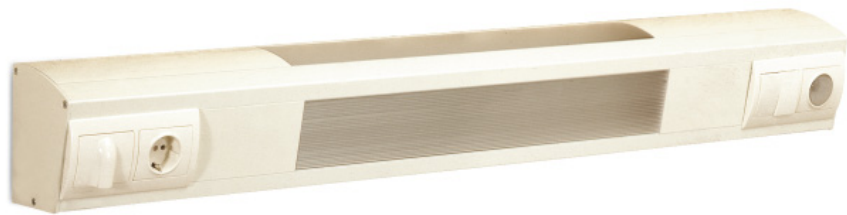

To customize the head light HOSPITAL should follow these instructions:

- 1- Choose the direct light.
- 2- Choose the indirect lighting.
- 3- Choose the direct light attached to profile.
- 4- Optional display mechanisms that are needed in positions A, B, C and D. If more mechanisms are needed, special lengths can be performed.

The luminaires are served with the choices of lighting and mechanisms chosen. It also incorporates a 50 cm wall support.

Cabezal HOSPITAL personalizada para iluminación directa y/o indirecta con mecanismos opcionales





Personalized HOSPITAL head light luminaire for direct and/or indirect light with optional mechanisms

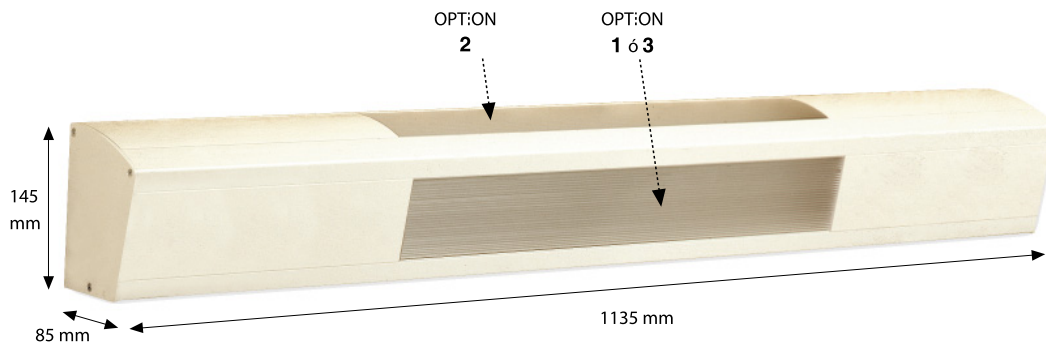
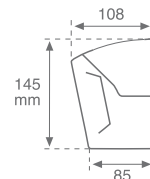



	Ref	Color	Plum
Cuerpo HOSPITAL para personalizar HOSPITAL body to personalize	85.03.01.7	■	1135

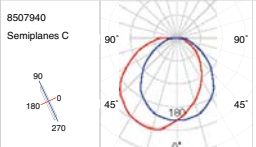



Opciones para Iluminación Directa incorporada a perfil
Options for direct lighting incorporated within the profile

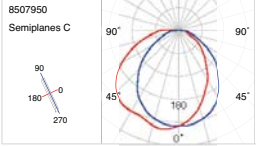

Lamp	Equipo / Gear	Ref	Color	W	Plum	
 T8/T26	Electromagnético	85.08.94.0		1 x 18	27,6W	8507940 Semiplanos C  h[m] 1 623 167 2.90 2.38 2 156 42 5.79 4.76 3 69 19 8.69 7.13 4 39 10 11.59 9.51 5 25 7 14.48 11.89 Im = 2700.00 F UTE 0.68 E + 0.00 T Imax = 245.43 cd/klm Eta = 68.27% G=18.0° Alpha=48.5°+48.7° Beta=50.4°+46.5°
	Electromagnetic	85.07.94.0		2 x 18	50,6W	



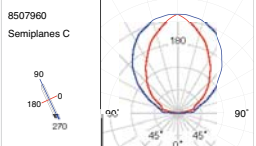

 T5/T16  color 840	Electrónico	85.07.95.0		2 x 14	34,5W	8507950 Semiplanos C  h[m] 1 686 178 3.12 2.30 2 172 45 6.24 4.59 3 76 20 9.35 6.89 4 43 11 12.47 9.18 5 27 7 15.59 11.48 Im = 2700.00 F UTE 0.74 E + 0.00 T Imax = 260.97 cd/klm Eta = 74.18% G=10.0° Alpha=57.7°+44.2° Beta=49.6°+47.4°
	Electronic					

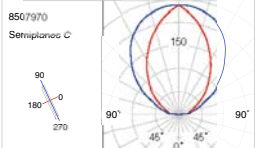

Opciones para Iluminación Indirecta incorporada a perfil
Options for indirect lighting incorporated within the profile

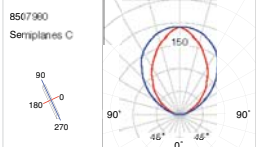

 T8/T26	Electromagnético	85.07.96.0		1 x 18	27,6W	8507960 Semiplanos C  h[m] 1 348 110 1.64 2.59 2 87 28 3.27 5.38 3 39 12 4.91 8.08 4 22 7 6.55 10.75 5 14 4 8.18 13.44 Im = 1350.00 F UTE 0.58 T Imax = 257.86 cd/klm Eta = 57.76% G=0.0° Alpha=39.3°+39.3° Beta=53.3°+53.3°
	Electromagnetic					



 T5/T16  color 840	Electrónico	85.07.97.0		2 x 14	34,5W	8507970 Semiplanos C  h[m] 1 642 224 1.41 2.40 2 160 56 2.81 4.80 3 71 25 4.22 7.21 4 40 14 5.62 9.61 5 26 9 7.03 12.01 Im = 2700.00 F UTE 0.48 T Imax = 237.67 cd/klm Eta = 48.43% G=0.0° Alpha=35.1°+35.1° Beta=50.2°+50.2°
	Electronic					

 TC-L	Electromagnético	85.08.06.0		1 x 36	50,6W	8507980 Semiplanos C  h[m] 1 924 321 1.55 2.33 2 231 80 3.11 4.66 3 103 36 4.66 6.99 4 58 20 6.21 9.32 5 37 13 7.77 11.65 Im = 4850.00 F UTE 0.39 T Imax = 190.48 cd/klm Eta = 38.84% G=0.0° Alpha=37.8°+37.8° Beta=49.3°+49.3°
	Electromagnetic	85.07.98.0		1 x 55	57W	

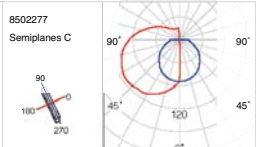

Opciones para Iluminación Directa adosada a perfil
Options for direct lighting to fix against the profile

 T8/T26	Electromagnético	85.02.27.7		2 x 18	50,6W	8502277 Semiplanos C  h[m] 1 2700.00 F UTE 0.46 J + 0.16 T Imax = 145.38 cd/klm Eta = 62.02%
	Electromagnetic					

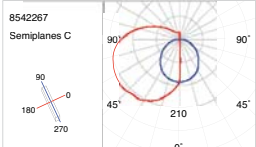
 T5/T16  color 840	Electrónico	85.42.26.7		2 x 14	34,5W	8542267 Semiplanos C  h[m] 1 2700.00 F UTE 0.92 J + 0.30 T Imax = 308.42 cd/klm Eta = 121.66%
	Electronic					

