

Art. 650



Deferrizzatori magnetici permanenti tipo TED

I deferrizzatori magnetici tipo TED sono apparecchiature semplici ed economiche. Si possono eventualmente fornire con gradini e sistemi di pulizia rapida a libro od a scorrimento e non necessitano di alcuna manutenzione. La protezione in acc. inox AISI 304 ed i magneti permanenti in ferrite consentono una durata nel tempo pressoché illimitata. Nel caso si necessiti più forza magnetica, a parità di dimensioni, si possono realizzare deferrizzatori potentissimi utilizzando magneti in terre rare.



Desferrizadores magnéticos permanentes tipo TED

Los desferrizadores magnéticos tipo TED son aparatos sencillos y económicos. Si se quiere, se pueden suministrar con peldaños y sistemas de limpieza rápida a libro o de deslizamiento y no necesitan ninguna mantenimiento. La protección en acero inoxidable AISI 304 y los imanes permanentes en ferrita permiten una duración en el tiempo prácticamente ilimitada. En caso de que se necesitara más fuerza magnética en igualdad de dimensiones, se pueden realizar desferrizadores potentísimos utilizando imanes en tierras raras.



Déferrisateurs magnétiques permanents type TED

Les déferrisateurs magnétiques type TED sont des appareils simples et économiques. Ils peuvent être éventuellement pourvus de marches et de systèmes de nettoyage rapide à livre ou bien à glissement et ils ne nécessitent pas d'entretien. La protection en acier inoxydable AISI 304 et les aimants permanents en ferrite assurent une durée presque illimitée dans le temps. S'il faut plus de force magnétique à égalité de dimensions, il est possible de réaliser des déferrisateurs très puissants en utilisant des aimants en terres rares.



Permanent magnetic deferrizers type TED

The magnetic deferrizers type TED are simple and cheap systems. They can be supplied with steps and quick cleaning hinged or slip systems and do not require any maintenance. AISI 304 stainless steel protection and ferrite permanent magnets allow a very long life of the equipment. In case more magnetic force is required with the same size, rare earth magnets allow to obtain very powerful deferrizers.



Dauer Magnetenteis ner vom typ TED

Die Enteiserer vom Typ TED sind einfache und billige Geräte. Sie können eventuell mit Stufen und Schnellreinigungssystem mit Scharnier oder gleitend hergestellt werden. Außerdem benötigen sie keinerlei Wartungsarbeiten. Durch den Schutz aus rostfreiem Stahl AISI 304 und die Dauermagnete aus Ferrit werden fast grenzenlose Haltbarkeiten erzeugt. Falls mehr Magnetwirkung bei gleichen Maßen notwendig sein sollte, können sehr starke Enteiserer unter Verwendung von seltenen Erden hergestellt werden.

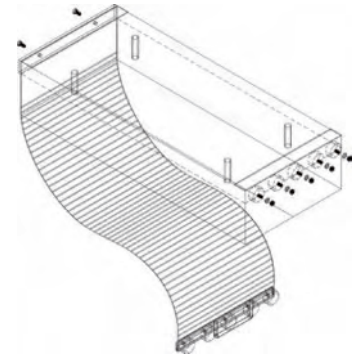
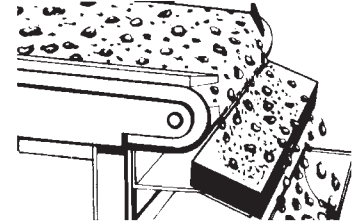
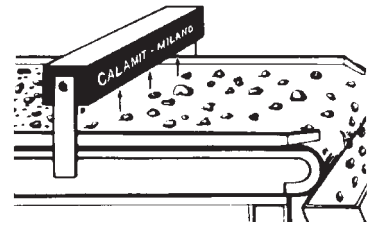

Sistema di pulizia rapida a tappeto
Sistema rápida limpieza de alfombras
Système de nettoyage des moquettes rapide
System fast carpet cleaning
Schnell Teppichreinigung

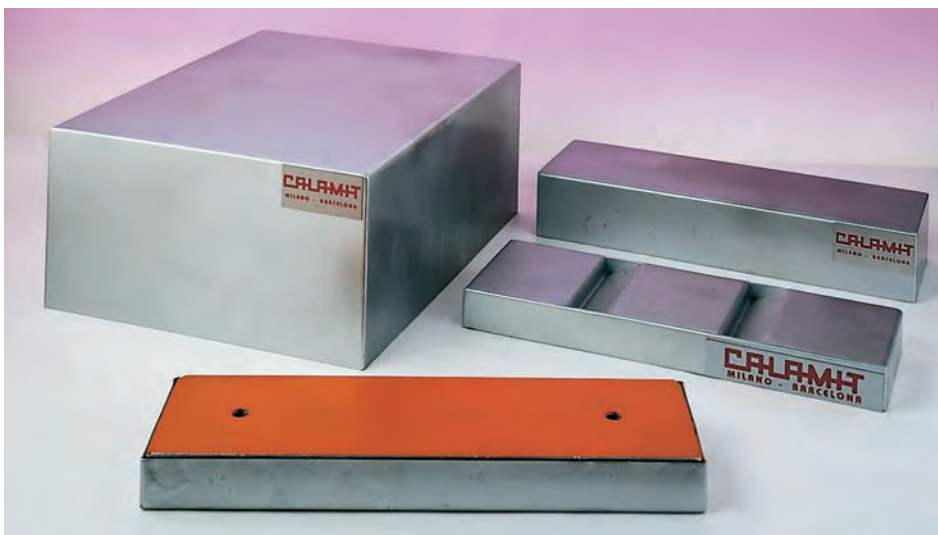

Sistema di pulizia rapida a cassetto
Sistema de limpieza rápida a cassetto
Système de nettoyage rapide à tiroir
Quick deck cleaning system
Schnelle Deck Reinigungssystem

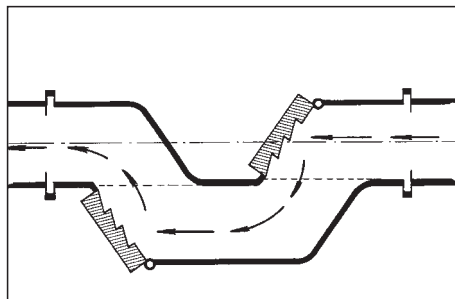
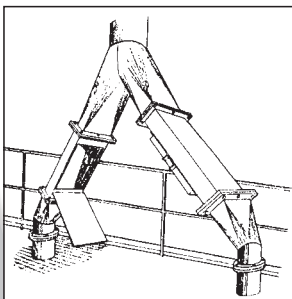

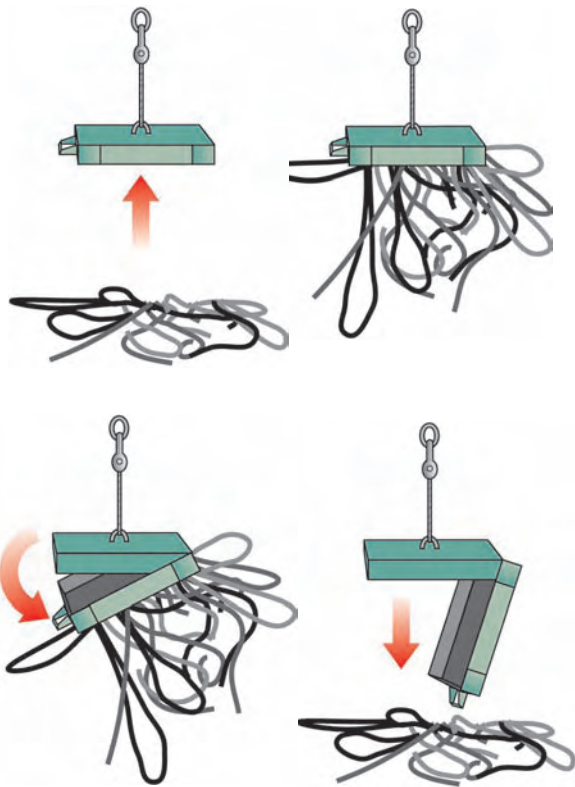

Sistema di pulizia rapida a libro · Sistema de limpieza rápida a libro
Système de nettoyage rapide à livre · Quick cleaning linged or slip systems
Plattensystem für schnelle Sauberkeit

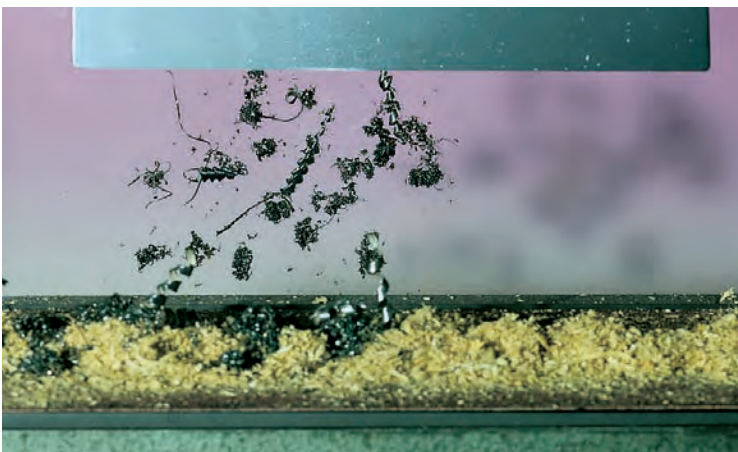
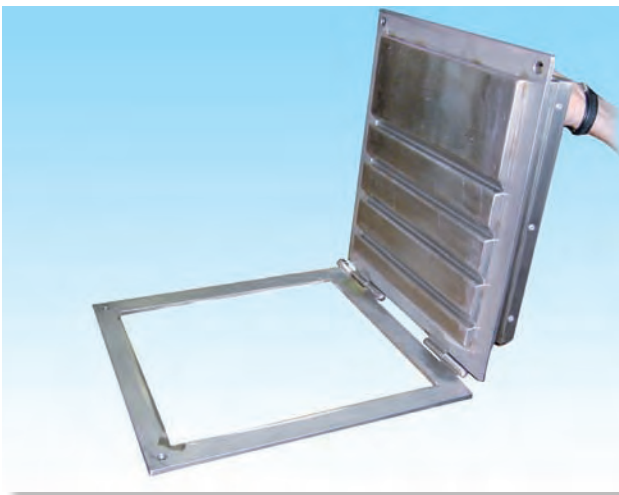

Realizziamo qualsiasi dimensione
Nos damos cuenta de todos los tamaños
Nous réalisons toutes tailles
We realize all sizes
Wir wissen alle Größen