

Revestimiento de paredes exteriores

 - **FACE**

**TWINSON®**

## **LO MEJOR DE AMBOS MUNDOS**

Bienvenidos al mundo de Twinson®, un entorno en donde la naturaleza y la tecnología se combinan a la perfección. El material de Twinson® se elabora con madera y PVC. La combinación de las ventajas de ambos elementos para crear

un material básico único e innovador permite a Twinson® ofrecerles lo mejor de ambos mundos: el aspecto natural y la sensación cálida de la madera junto con la gran duración y el bajo mantenimiento del PVC.



**MADERA**



**PVC**



**TWINSON®** combina todas las ventajas de la madera y del PVC:

- |                             |                              |
|-----------------------------|------------------------------|
| ● aspecto natural           | ● no se agrieta              |
| ● duradero                  | ● fácil de instalar          |
| ● no se astilla             | ● no se dobla                |
| ● bajo mantenimiento        | ● sistema oculto de fijación |
| ● resistente a los insectos | ● no daña al medio ambiente  |
| ● resistente al agua        |                              |

Son de aplicación las condiciones generales de garantía.

**- FACE**  
**9558**



Perfil de comienzo



Conector lateral



Esquina interior con perfil



Perfil de acabado esquina interior



Esquina interior sin perfil



Esquina exterior

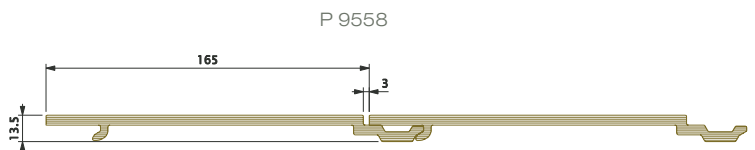
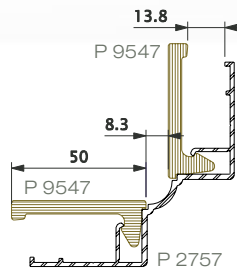
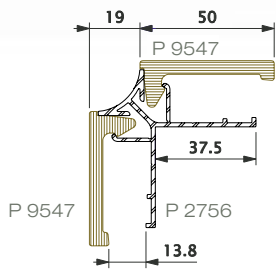
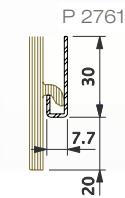
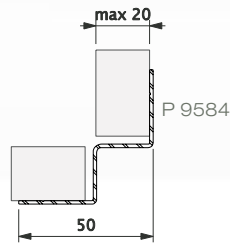
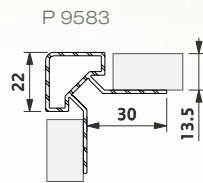
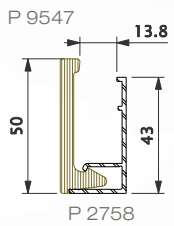



**FACE**

**9580**



Perfil de esquina interior 1



Perfil de esquina interior 2

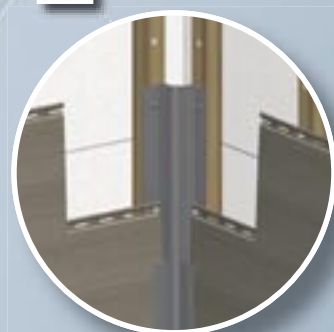

**FACE**

## **GARANTIZAMOS SU COMODIDAD**

Twinson® les proporciona todos los beneficios de la madera y, al mismo tiempo, les permite disfrutar de las propiedades únicas del PVC. Gracias a la combinación de la madera y del PVC en un único nuevo material, Twinson® satisface las demandas de confort que usted espera de sus revestimientos de exterior. Resistencia al agua y robustez, bajo mantenimiento y atractivo.

FACE tiene todo!

Twinson® combina el tacto cálido de la madera

y la durabilidad del PVC. Gracias a su apariencia natural, estos revestimientos se acoplan perfectamente en su hogar. Con la resistencia al agua de Twinson®, este revestimiento permanecerá como nuevo, además de no partirse, no desprender astillas y no agrietarse.

En cualquier parte de su vivienda: FACE le proporciona el confort que usted demanda desde hace tiempo.





Perfil de esquina exterior 1



Perfil de esquina exterior 2



**FACE**  
**9581**

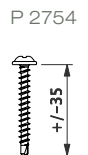
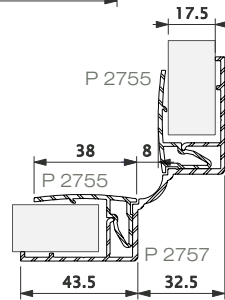
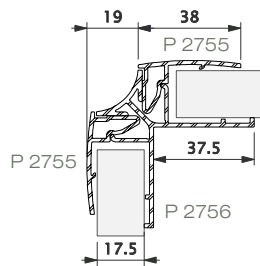
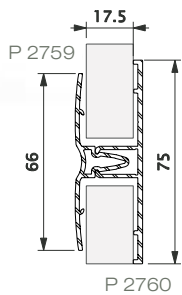
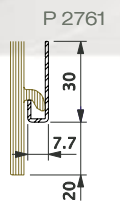
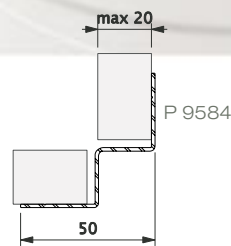
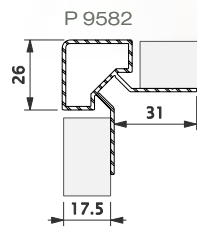
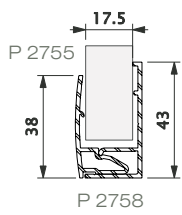



Perfil de comienzo



Perfil para lateral

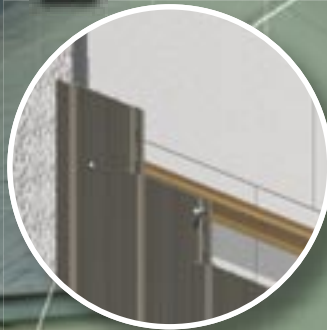

Perfil para esquina interior



Esquina exterior



**FACE**  
**9553**

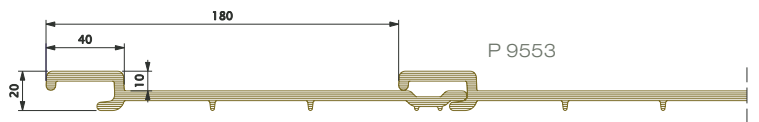
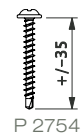
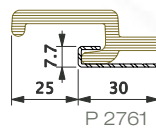
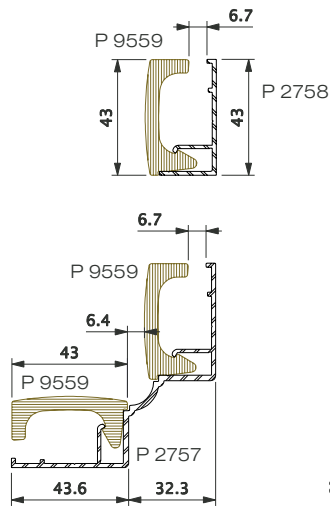
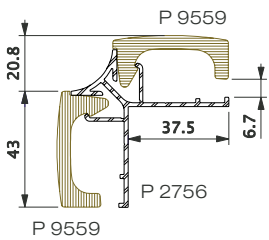

# TWINSON<sup>®</sup>

## DE RIENDA SUELTA A SU IMAGINACIÓN

Con Twinson<sup>®</sup> usted podrá dar rienda suelta a su creatividad Desde diseños simétricos o formas geométricas imaginativas, con Twinson<sup>®</sup> puede lograr lo que desee! -Face para revestimiento está disponible en 8 colores naturales diferentes, desde el

beige almendra al negro regaliz.

Con el empleo de Twinson<sup>®</sup> usted podrá obtener un acabado elegante para su vivienda que podrá disfrutar durante años.

0501



BEIGE ALMENDRA

0507



VERDE ACEITUNA

0503



MARRÓN AVELLANA

0504



MARRÓN CORTEZA

0508

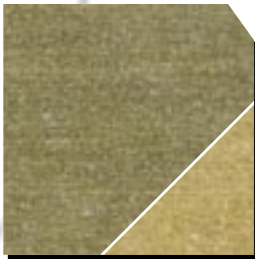

AMARILLO NECTAR

0506



MARRÓN ALBARICOQUE

0505

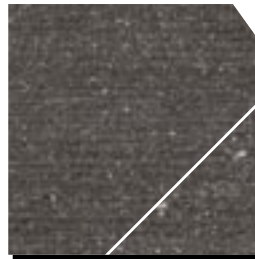

MARRÓN CESPED

0502

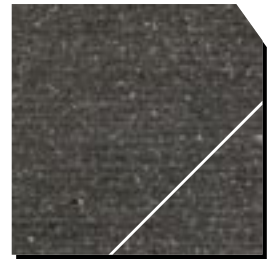

NEGRO REGALIZ

Las muestras de color son reproducciones y pueden variar respecto a los tonos originales. El triángulo indica la tonalidad natural que el material adquiere con el paso del tiempo.

