

bjç Aura

bjç Magna

bjç Iris





BJC IRIS. DEFIENDE TU ESTILO.

El interruptor con radio incorporada quedaría perfecto encima de la cabecera.
-Es verdad. ¡Que bien escuchar las noticias desde la cama! -¿Y el pulsador de persianas, que te parece? Un botón y nos ahorramos esfuerzos de buena mañana. -¡Genial! Yo me quedo con las dos opciones. Además están las dos en color verde - ¿Verde? Mejor rojo. -No, no. El verde es perfecto para el dormitorio. -Pero los armarios son oscuros. El rojo combina mejor. -El verde también ¡Verde! ¡Rojo!

Todos tenemos una forma diferente de ver el mundo, de interpretar los espacios. Tenemos una personalidad propia que nos hace únicos. Lo que para unos es blanco, es negro para otros y azul para los demás. Descubre la serie Bjc Iris.

Todo un mundo de posibilidades para expresar tus preferencias, tu propio estilo. Elige la opción que más hable de ti sin miedo. Su equilibrado y suave diseño consigue expresar tu personalidad adaptándose perfectamente a la decoración de tu hogar. La elección es tuya. Ahora sólo falta ponerse de acuerdo.

BJC IRIS. ¿CUÁL



Opción tradicional.

Su estructura ha sido diseñada ergonómicamente para garantizar una instalación fácil, rápida y cómoda. Cuenta con un mecanismo de tamaño ajustado que permite aprovechar al máximo el espacio interior en la caja de empotrar y facilita el paso del cableado.

¿PREFIERES?



Opción de radiofrecuencia.

La opción de radiofrecuencia de Bjc te permite colocar los receptores que necesites allí donde quieras. Con la máxima facilidad y limpieza, sin necesidad de cableado. Sin cables, sin obras, sin complicaciones.



Regulador de luz + Doble interruptor con
señalizador luminoso



Doble interruptor
+ Regulador de sonido



Doble interruptor con señalizador luminoso
+ Base de enchufe 2P+T seguridad



Interruptor con señalizador luminoso
+ Receptor de infrarrojos.



Toma RJ 45
+ Entrada de RTV /SAT



Interruptor
+ Doble pulsador electrónico de persianas



Doble interruptor + Base de enchufe con
tapa de seguridad



Doble interruptor con señalizador luminoso
+ Base de enchufe con tapa de seguridad

¿QUÉ FUNCIONES PIDE TU CONFORT?

La serie Bjc Iris dispone de un amplio y variado abanico de funciones para cada persona. Reguladores de intensidad de luz, controladores de sonido, mecanismo de subida y bajada de persianas. Elige las opciones que necesites para tu total comodidad y disfruta del confort con todo el diseño y color de Bjc Iris.



Interruptor



Interruptor con
señalizador luminoso



Doble interruptor



Regulador de temperatura



Base de enchufe
con tapa



Salida de cable



Interruptor Conmutador
para tarjetas



Entrada de antena
TV / FM / SAT



Entrada de teléfono + entrada de antena



Interruptor con señalizador luminoso
+ Doble base de enchufe



QUE MIS MOMENTOS DE RELAX SEAN DE VERDAD.

¿Por qué levantarse una y otra vez para bajar persianas, apagar luces o regular la temperatura en los momentos de relax? Cuando llego a casa cansada del trabajo quiero sentir el confort de verdad.

Sin esfuerzos, sin interrupciones. La única actividad que me permito cuando necesito tranquilidad es echarme en el sofá. Nada más. Ya me he movido suficiente durante todo el día.

Receptor de infrarrojos y mando a distancia BJC Iris.

El receptor de infrarrojos y el mando a distancia BJC Iris permiten el control a distancia de una extensa variedad de aplicaciones pensadas para tu máximo confort. Acondiciona el hogar a tu gusto tan sólo pulsando un botón..



Receptor de infrarrojos



Mando a distancia

Diferentes opciones para tu máximo confort en el hogar.

La serie Bjc Iris incorpora una amplia gama de posibilidades que te permiten disfrutar de toda la comodidad y confort que necesites para tu bienestar.



Regulador de sonido



Interruptor con señalizador luminoso



Doble Interruptor



Base de enchufe



Interruptor



Interruptor + Doble pulsador de persianas



Entrada de antena R/TV / SAT



Doble interruptor con señalizador luminoso



Conmutador



Regulador de fluorescencia



Pulsador electrónico de persianas



Interruptor + Base de enchufe



NUESTRA FELICIDAD, JUGAR DESPUÉS DEL BAÑO.

Que sensación tan agradable salir del agua y no tener frío. ¡Así da gusto salir del baño! Ni frío ni calor. La temperatura perfecta en casa. Ahora un poco de juego para abrir el apetito, biberón y

a dormir. Con este ambiente tan agradable y un poco de suerte, quizás nos dejarás dormir unas horitas esta noche.

Termostato digital Bjc Iris.

El termostato digital Bjc Iris es una aplicación fácil y silenciosa que aporta un gran confort tanto en tu casa como en el lugar de trabajo. El sistema presenta una escala de ajuste de +5°C a +30°C con topes para delimitar un rango menor de ajuste, entre un mínimo y un máximo.



Termostato digital



Foto detalle de la pantalla termostato digital

Diferentes opciones para un trabajo perfecto.

La serie Bjc Iris incorpora una amplia gama de posibilidades que dotan a tu hogar de las condiciones idóneas para un resultado perfecto.



Doble interruptor con señalizador luminoso



Doble pulsador electrónico de persianas



interruptor + Base de enchufe



Doble interruptor



Base de enchufe



Interruptor



Regulador de sonido



Interruptor



Interruptor con señalizador luminoso



Doble interruptor



Regulador de temperatura



Regulador de luz + Doble interruptor con señalizador luminoso



Doble interruptor con señalizador luminoso + Base de enchufe 2P+T seguridad



¿CUÁL ES TU COLOR?

Verde de natural, naranja de espontáneo, rojo de apasionado, blanco de equilibrado. ¿Cuál es el color que te define? Te invitamos a descubrir y expresar tu propio estilo con Bjc Iris. Una serie de diseño con una amplia gama de colores que te permite escoger la opción que más hable de ti, el color que va con tu personalidad.

Básicos



Blanco

Beige

Pasteles



Amarillo Vainilla

Azul Lavanda

Verde Menta

Metalizados



Acero
Neptuno

Aluminio
Mercurio

Dorado
Odisea

Cobre
Jaipur

Rojo
Rubí

Verde
Minerva

Azul
Ming

Metalizados con negro Antracita



Acero
Neptuno

Aluminio
Mercurio

Dorado
Odisea

Cobre
Jaipur

Rojo
Rubí

Verde
Minerva

Azul
Ming

Naturales



Nácar

Granito

Haya



BJC IRIS. DISEÑO EN TODOS LOS DETALLES.



La entrada de los conmutadores con llave presenta un diseño circular de suave volumen que consigue integrar la aplicación con el diseño original de la serie.



La amplia gama de colores de la serie permite ofrecer la mejor respuesta a las diferentes necesidades estéticas del usuario.



Acabados de calidad que permiten escoger desde la serenidad y elegancia del Aluminio Mercurio al dinamismo y vitalidad del Rojo Rubí.



La línea curva, presente en cada una de las partes que forman la pieza, aporta dinamismo y unidad estética en todas las opciones de la serie.



El suave diseño curvilíneo que caracteriza la serie está presente en todas las opciones de Bjc Iris, incluso en las piezas dobles.



Dígitos luminosos nítidos y de fácil lectura para las funciones de detección de temperatura, reloj y despertador.



Iconos claros y respetuosos con la superficie de la pieza y leds luminosos que aúnan funcionalidad y diseño.

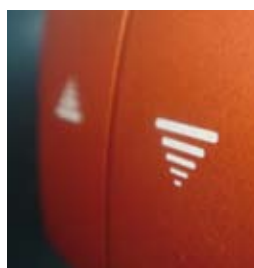

Los iconos consiguen integrarse en cualquiera de las múltiples opciones cromáticas que ofrece la serie.



Marco y tecla forman una misma unidad estética, aportando funcionalidad y diseño a la pieza.



Las distintas funciones que ofrece la serie quedan integradas en la pieza de forma discreta y respetuosa con su diseño original.



Bjc Room Manager



Actuador de interrupción

BJC te ofrece 5 actuadores diferentes para cubrir todas las necesidades:

- Actuador de interrupción.
- Actuador para persianas.
- Actuador dimmer.
- Actuador de interrupción libre de tensión.
- Actuador de interrupción bipolar.



Emisor Universal

Emisores que van desde el universal de 2 canales, al alimentado por pila, o al emisor de temperatura mediante sonda.



Interruptor RF_Bjc Iris

BJC ROOM MANAGER. EL CONTROL DEL CONFORT

La opción radiofrecuencia consta de un actuador y de un emisor encargado de enviar la orden deseada por el usuario a través de la banda de frecuencia 868 MHz. Una avanzada comunicación que garantiza un menor riesgo de interferencias de la señal de radio y un mayor poder de comunicación.

Ventajas instalador.

Una instalación más fácil y rápida.

La intervención se limita a un emisor y un actuador. Sin cables, sin regatas. Mínima infraestructura, máxima rapidez en la instalación.

Resultado perfecto con el menor coste.

La sencillez de la instalación garantiza un óptimo resultado sin requerir materiales adicionales ni aplicaciones de refuerzo.

Máxima autonomía en el trabajo.

El sistema sin cableado permite una instalación más rápida y dinámica.

El mantenimiento más cómodo.

La facilidad de la opción radiofrecuencia permite una rápida identificación de incidencias y un mantenimiento simple y rápido.

Ventajas usuarios.

Sin obras.

La radiofrecuencia permite una instalación limpia y fácil sin necesidad de obras. La intervención se reduce a la implantación del actuador y de los emisores deseados por el usuario.

Libertad de creación.

El sistema sin cableado permite al usuario disponer libremente de todas las prestaciones que desee en cualquier estancia de su vivienda.

Menor intervención, menor coste.

La instalación de la opción radiofrecuencia requiere una menor intervención, por lo que el coste final de la operación es más reducido.

Pensando en el futuro.

Las reformas ya no son ninguna molestia. Al no requerir obra ni cableado, cualquier mejora o cambio en el hogar es siempre rápida y limpia.





Interruptor RF_Bjc Iris



Gestiona la ventilación de la cocina.



Gestiona la intensidad de luz más agradable del dormitorio.



Gestiona la temperatura perfecta de la sala de estar.



Pulsador simple.



Pulsador doble.



Pulsador con señal on/off.



Pulsador doble con señal on/off.



Pulsador simple para persiana.



Pulsador doble para persiana o dimmer.

La forma más cómoda de gestionar hasta tres espacios del hogar a la vez.

Confort y ahorro.

Bjc Room manager permite programar fácilmente opciones binarias y controla un amplio abanico de funciones que facilitan al usuario las tareas domésticas más comunes.

- Temperatura. Hasta cinco diferentes opciones programables.
- Calefacción. General y de tierra.
- Iluminación. Función de apagado y encendido de luces y regulador de intensidad.
- Ventilación. Tres perfiles predefinidos.
- Toldos/persianas. Incorpora tres sistemas de protección solar. Con la opción "All room" el sistema permite aplicar un mismo programa a tres habitaciones independientes.

Seguridad.

A través de la simulación de presencia "Holiday" la opción consigue evitar posibles intentos de intrusión cuando no hay nadie en casa. Tan fácil como introducir en el Bjc Room manager los datos de inicio y final de vacaciones o salidas y definir las operaciones cotidianas dentro del hogar, y las efectuará aleatoriamente en intervalos de 10 minutos a una hora. Bjc Room manager también incorpora un código de acceso que evita que personas no autorizadas por el usuario lo puedan manipular.

Ampliación.

Este abanico de posibilidades ofrece, además, un gran potencial de ampliación que le permite, incluso, estar conectado a los sistemas domóticos de Bjc.





IMPONENTE EN DISEÑO Y FUNCIONALIDAD.

Bjc Aura no ha sido creada para pasar desapercibida. Su diseño suntuoso y el encanto de sus embellecedores la convierten en una pieza siempre protagonista. Sin embargo, sólo tú sabes que funciones necesitas para sentir el confort. Tú eres el verdadero protagonista. Por ello, Bjc Aura te ofrece una amplia gama de opciones de calidad para que puedas escoger aquellas funciones que mejor se adapten a tu forma de entender la comodidad.



Regulador de luz + Doble interruptor con
señalizador luminoso



Doble interruptor
+ Regulador de sonido



Doble interruptor con señalizador luminoso
+ Base de enchufe 2P+T seguridad



Interruptor con señalizador luminoso
+ Receptor de infrarrojos.



Toma RJ 45
+ Entrada de RTV /SAT



Interruptor
+ Doble pulsador electrónico de persianas



Doble interruptor + Base de enchufe con
tapa de seguridad



Doble interruptor con señalizador luminoso
+ Base de enchufe con tapa de seguridad

¿POTENCIAR O SUAVIZAR SU DISEÑO?

¿Enfatizar aún más el diseño extrovertido de Bjc Aura con un brillante metalizado, o bien actualizar su imagen con un acabado en mate? Descubre la completa variedad de colores en brillo o mate que ofrece la serie y escoge la opción que mejor se adapte a tus espacios. Tú eliges el color que mejor combina con el diseño de Bjc Aura.



Interruptor



Interruptor con
señalizador luminoso



Doble interruptor



Regulador de temperatura



Base de enchufe
con tapa



Salida de cable



Interruptor Conmutador
para tarjetas



Entrada de antena
TV / FM /SAT



Entrada de teléfono + entrada de antena



Interruptor con señalizador luminoso
+ Doble base de enchufe



¿POR QUÉ ESPERAR A LA NAVIDAD PARA DISFRUTAR DE LA FAMILIA?

Siempre me ha gustado sentirme cerca de mi familia. Ya sea por teléfono o a través del correo electrónico, procuro mantener el máximo contacto posible con los míos. Disfruto hablando de nuestras novedades, riendo de las anécdotas del pasado y, sobretodo, organizando comidas familiares en mi propio hogar.

Me ilusiona ver a padres, hermanos, hijos, novias, tan a gusto en mi comedor. Son momentos muy especiales en los que la vitalidad infantil coincide con la experiencia de los más mayores. Momentos difíciles de explicar con palabras que no quiero esperar a que sea navidad para disfrutarlos.

Interruptor + Regulador Intensidad de luz Bjc Aura.

El interruptor más regulador de intensidad de luz Bjc Aura es una pieza elegante y funcional que, además de encender y apagar las luces del hogar, te permite regular a tu gusto su intensidad con total comodidad y exactitud.



Interruptor + Regulador
Intensidad de luz



Diferentes opciones para crear un ambiente cálido en el hogar.
 Bjc Aura te ofrece diferentes opciones de confort y bienestar para que tú y los tuyos disfrutéis de un ambiente siempre cálido en todos los espacios de tu hogar.



Interruptor



Doble pulsador persianas



Interruptor con señalizador luminoso + Base enchufe



Interruptor



Pulsador luz



Interruptor + Base enchufe



Regulador Intensidad de luz

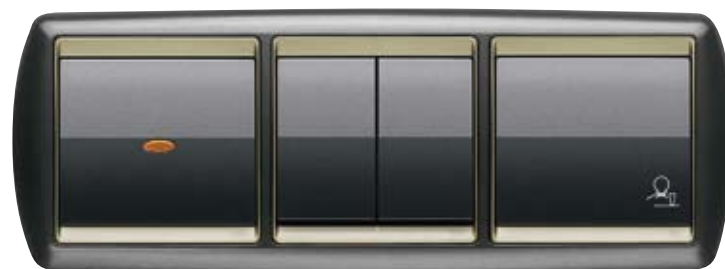

Interruptor con señalizador luminoso + Doble Interruptor + Pulsador aviso servicio



Doble pulsador persianas



Pulsador luz



Interruptor + Base enchufe



EL DISEÑO MÁS EXTROVERTIDO.

Curvas suntuosas, atractivos acabados metalizados, descarados embellecedores. Bjc Aura es una serie nacida para seducir. Una pieza de diseño extrovertido con la suficiente fuerza y encanto para no dejar a nadie indiferente.

Básicos



Blanco



Beige

Metalizados Brillo



Dorado Arena



Rojo Protero



Acero Volcán

Metalizados Mate



Dorado Odisea



Aluminio Mercurio



Acero Neptuno

Natural



Nácar





BJC MAGNA. PENSANDO EN GRANDE.

Llámalo debilidad, llámalo predilección, incluso puedes llamarlo pasión. Cuando algo te gusta, quieres disfrutarlo en grande. Este es el espíritu de Bjc Magna, la gama alta de Bjc en pequeño material eléctrico. Una serie de gran tamaño enmarcada con el material más exclusivo. Disfruta plenamente de la

distinción del cristal y de la nobleza de la mejor madera en las diferentes opciones que te proponemos. Cristal Blanco satinado, cristal Azul brillo, o bien madera noble de Arce, Roble, Cerezo y Wengué. Bjc Magna. Porque el mejor material pide algo más que un tamaño standard.





VERSATILIDAD Y DISTINCIÓN.

La gama alta de BJC en pequeño material eléctrico enmarca con el material más noble todas las funciones que necesites para sentir el máximo confort en tus espacios. Reguladores de intensidad de

luz, controladores de sonido, mecanismo de subida y bajada de persianas. Elige las opciones que pide tu bienestar y vístelas con el material más selecto.

Cristal azul brillo



Interruptor



Interruptor conmutador para tarjetas



Salida de cable



Base de enchufe con tapa



Receptor de infrarrojos



Doble interruptor con señalizador luminoso



Pulsador simple para persiana



Doble pulsador con bloqueo electrónico de persianas



Pulsador electrónico de persianas



Regulador de temperatura



Entrada de RTV/SAT



Toma RJ45

¿QUÉ FUNCIONES PIDE TU CONFORT?

Todos tenemos una forma diferente de entender el confort, de disfrutar la comodidad. Por ello, la serie Bjc Iris dispone de un amplio y variado abanico de funciones para cada persona. Reguladores de intensidad de luz, controladores de sonido, mecanismo de subida y bajada de persianas. Elige las opciones que necesites para tu total comodidad y disfruta del confort con todo el diseño y color de Bjc Iris.

Madera noble de roble



Doble Interruptor



Interruptor



Doble Toma RJ45



Receptor de infrarrojos



Pulsador simple para persiana



Entrada de RTV/SAT



Base de enchufe



Doble pulsador electrónico de persianas



Regulador de sonido



EL CLIENTE SE FIJA MÁS EN LOS DETALLES QUE EN LAS ESTRELLAS.

Gestionar un hotel implica dedicación, compromiso, profesionalidad y, sobretodo, mucha ilusión. Ilusión por ofrecer el mejor servicio en todo momento, por lograr la máxima satisfacción de los clientes, por crear espacios que les hagan olvidar que están lejos de su hogar. Ilusión por considerar cada detalle como el mejor argumento para sentirme orgulloso de

mi hotel. Desde la decoración al desayuno, desde la primera impresión a la exquisitez en la despedida. Todo ha de transmitir elegancia y funcionar a la perfección. La calificación cuatro estrellas no sólo ha de estar presente en el rótulo, se ha de respirar en cada detalle del Hotel.

Conmutador tarjetas Bjc Magna.

El conmutador de tarjetas Bjc Magna es una perfecta solución de seguridad, diseño y comodidad, creada para satisfacer las nuevas necesidades estéticas y funcionales en el ámbito de la hostelería. Un sistema automático de identificación, activación e interrupción de la electricidad que evita el gasto innecesario de energía y ofrece al cliente una estancia mucho más confortable. La aplicación incorpora hasta dos microrruptores indicadores de luz incorporados y una entrada de lectura de tarjetas fácil de usar e integrada con la elegancia estética de Bjc Magna.



Sin llaves, sin preocupaciones.

La opción ofrece al cliente la comodidad de disfrutar de una estancia más cómoda, sin llaves ni preocupaciones, añadiendo un toque de elegancia y distinción en todas las habitaciones.

Soluciones de equipamiento con la máxima elegancia.

La serie Bjc Magna te ofrece una completa gama de posibilidades para que puedas equipar de la forma más exclusiva todos los espacios del hotel. Por supuesto, también los de tu hogar.



Interruptor



Doble interruptor con
señalizador luminoso



Pulsador electrónico de
persianas



Salida de cable



Regulador de sonido



Base de enchufe con tapa
de seguridad



Entrada de antena TV/FM/SAT



Regulador de sonido



Interruptor con señalizador
luminoso



Pulsador doble con señal on/off



Entrada de teléfono



Base de enchufe 2P



Cuando presento una idea, un proyecto o, sencillamente, quiero mostrarle la empresa a alguien, me gusta que cada detalle hable de nuestra profesionalidad. La decoración, el mobiliario, la luz, la tecnología, el vestuario, un aperitivo. Todo lo que el cliente perciba de nosotros puede convertirse en un

motivo de confianza e, incluso, puede condicionar nuestras futuras relaciones comerciales. La pasión por cuidar hasta el último detalle no sólo se expresa con palabras. Es necesario demostrarla con ideas, proyectos, experiencias, resultados y, por supuesto, se ha de poder captar en una simple mirada.

LA PROFESIONALIDAD SE CAPTA EN UNA MIRADA.

Interruptor infrarrojos y mando a distancia Bjc Magna.

El interruptor de infrarrojos y el mando a distancia Bjc Magna permiten el encendido y apagado de luces, tanto halógenas como fluorescentes, sin necesidad de moverse de la mesa de trabajo. El interruptor ofrece 1500W de carga resistiva y el mando a distancia presenta un alcance de ocho metros, quince teclas para gobernar hasta nueve receptores infrarrojos por habitación y tres teclas de pulsación simultánea. La combinación de estos dos elementos es una herramienta perfecta para realizar presentaciones y reuniones de trabajo más cómodas y eficaces, además de una elegante solución de diseño que consigue adaptarse a cualquier espacio.



Interruptor Infrarojos



Una opción práctica y eficaz.

El sistema se acciona pulsando un sólo botón y ofrece un alcance de ocho metros que garantiza una recepción de la señal siempre clara y sin problemas.

Soluciones de trabajo con la máxima elegancia.

Bjc Magna te ofrece una amplia gama de soluciones en comodidad y comunicación para que puedas equipar con la máxima elegancia y eficiencia tus espacios de trabajo.



Regulador de temperatura



Pulsador simple para persiana



Interruptor



Entrada de RTV/SAT



Entrada de teléfono



Doble interruptor



¿CRISTAL O MADERA?

¿La sutileza y distinción del cristal o la nobleza natural de la madera? Tú eliges. Tienes una selecta gama de posibilidades por elegir. Desde el cristal Blanco satinado, cristal Azul brillo, hasta la madera noble de Arce, Roble, Cerezo y Wengué. Tú decides la opción Bjc Magna que combina mejor con tus espacios.

Cristal



Blanco Satinado



Azul Brillo



Negro Brillo

Madera noble



Arce



Roble



Cerezo



Wengué



MECANISMO PARA CABLEADO.

El mecanismo y la toma de corriente presentan un ajustado tamaño que permite conectar el conductor con comodidad y facilita el paso del cableado.

bjc Iris



- A_ Tecla basculante
- B_ Pieza intermedia
- C_ Marco
- D_ Mecanismo

bjc Aura



- A_ Tecla basculante
- B_ Pieza intermedia
- C_ Embellecedor
- D_ Marco
- E_ Mecanismo

bjc Magna



- A_ Tecla basculante
- B_ Pieza intermedia
- C_ Marco y embellecedor
- D_ Mecanismo



MECANISMO PARA RADIOFRECUENCIA.

El sistema de radiofrecuencia de Bjc con banda de frecuencia 868 MHz permite ubicar los emisores que el usuario necesite allí donde quiera sin riesgo de interferencias ni necesidad de cableado.

bjc Iris

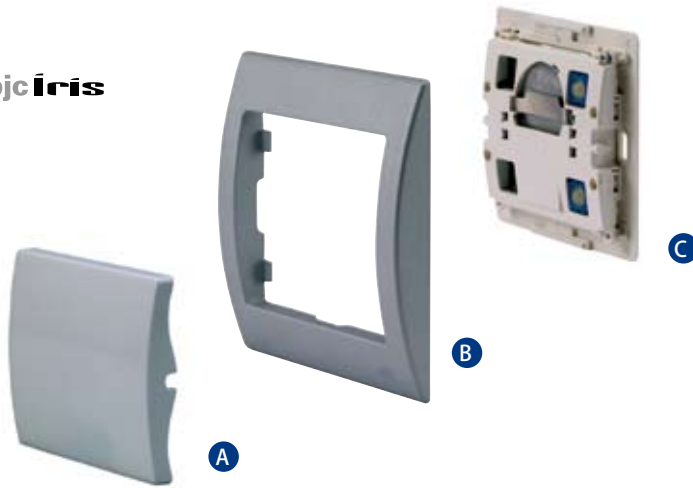

- A_ Tecla Radiofrecuencia
- B_ Marco
- C_ Mecanismo Radiofrecuencia

bjc Aura



- A_ Tecla Radiofrecuencia
- B_ Embellecedor
- C_ Marco
- D_ Mecanismo Radiofrecuencia

bjc Magna



- A_ Tecla Radiofrecuencia
- B_ Marco y embellecedor
- C_ Mecanismo Radiofrecuencia



TODAS LAS FACILIDADES PARA UNA PERFECTA INSTALACIÓN.

Los productos de BJC nacen con el objetivo de satisfacer tanto las necesidades del cliente final como las del instalador.

La estructura y prestaciones de las series han sido desarrolladas siguiendo siempre un criterio ergonómico que garantice, una instalación fácil, rápida y cómoda.



Espacio interior de las cajas de empotrar más amplio y manejable.

El mecanismo presenta un ajustado tamaño que permite aprovechar al máximo el espacio interior en la caja de empotrar y facilita el paso del cableado.



16 A. en los mecanismos de interrupción.

Los mecanismos de interrupción cuentan con un potente dispositivo de 16 A de emborne automático diseñado ergonómicamente para una manipulación más cómoda, fácil y segura.



Las muescas laterales del bastidor garantizan un perfecto alineamiento y posicionamiento de los marcos.

Bastidores de calidad sin ángulos agresivos para una instalación fácil y de manipulación ergonómica



Ventanas de ventilación que impiden el calentamiento excesivo del interior de la caja.

Medida del conductor para embornar.



Emborne automático y ergonómico con relieve anti-deslizante para una mejor y más cómoda manipulación. Cuenta además, con una práctica señalización en rojo de la toma fase, más medida del conductor para embornar.



Marcas de posición grabadas en el emborde que facilitan el trabajo del instalador.



Bastidor metálico

Alto poder de ruptura

Los interruptores están provistos de contactos de plata de máxima pureza (900/1000) que garantizan un alto grado de conservación y nivel de prestaciones.



Sistema "stai"

Las bases de enchufe cuentan con el sistema de embornado stai (sistema de tornillo abierto imperdible), los tornillos se cierran con una sola operación y disponen de una tuerca flotante grabada que impide el deslizamiento del cable.



RADIOFRECUENCIA DISEÑADO PARA TU COMODIDAD.

La opción radiofrecuencia de Bjc te permite ubicar los mecanismos que necesites allí donde quieras con la máxima facilidad, fiabilidad y limpieza. Sin cables, sin complicaciones, sin obstaculizar nunca tu libertad de creación. Su tecnología basada en la optimización del espacio consigue integrarse perfectamente al diseño de las series, respetando toda la elegancia y el equilibrio que caracteriza su estética. La estructura y prestaciones de las series han sido desarrolladas siguiendo siempre un criterio ergonómico que garantice, una instalación fácil, rápida y cómoda.



Doble push button de accionamiento.



Pila de litio de 3 V incorporada de 10 años de duración.

El espacio en el que se ubica la pila permite una introducción rápida y fácil e incorpora una tira metálica que evita cualquier movimiento de la misma.



Marca de situación que indica la posición correcta del enchufe durante su instalación.

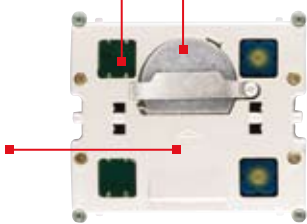

Cuatro anclajes de atornillado en la base de sujeción para una potente fijación con el mecanismo.



La base de sujeción presenta un diseño especial que garantiza la perfecta fijación del mecanismo con el marco.

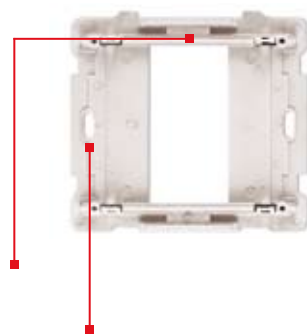

Dos fuertes adhesivos ubicados en ambos lados de la base permiten una rápida y cómoda instalación.



Los anclajes de la base de sujeción permiten un atornillado fácil y seguro sobre una gran variedad de superficies.



**SISTEMA EUROPEO
MECANISMOS**



Commutador + Pulsador **18515**
16 A + 10 A 250 V~

Envase 10

IRIS / AURA MATE / MAGNA



BLANCO **18715-L** BEIGE **18715-AL** N. ANTRACITA **18715-ATL** DOR. ODISEA **18715-ODL** ALUM. MERC. **18715-MAL**



BLANCO **18715** BEIGE **18715-A** N. ANTRACITA **18715-AT** DOR. ODISEA **18715-OD** ALUM. MERC. **18715-MA**

Interruptor - Conmutador para tarjeta con 1 microruptor indicador luminoso incorporado

Con lámpara incorporada de Neón
10 (1,5) A 250 V~

Para cargas inductivas se recomienda el uso de un contactor.



BLANCO **18068** BEIGE **18068-A** N. ANTRACITA **18068-AT** DOR. ODISEA **18068-OD** ALUM. MERC. **18068-MA**

Interruptor - Conmutador para tarjeta con 2 microruptores indicador luminoso incorporado

Con lámpara incorporada de Neón
2x10 (2x1,5) A 250 V~

Para cargas inductivas se recomienda el uso de un contactor.



BLANCO **18168** BEIGE **18168-A** N. ANTRACITA **18168-AT** DOR. ODISEA **18168-OD** ALUM. MERC. **18168-MA**

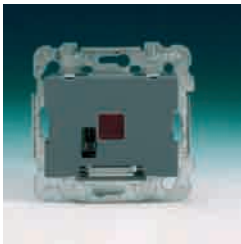

Interruptor para tarjeta temporizado **18668**

125-230 V~ 50/60 Hz
Cargas resistivas 10A~ 6A ...
Cargas inductivas 8A Cos φ 0,4
Retardo a desconexión 1 min
Indicador LED

No apto para garras

Envase 1



BLANCO **18868** BEIGE **18868-A** N. ANTRACITA **18868-AT** DOR. ODISEA **18868-OD** ALUM. MERC. **18868-MA**

Sólo se puede montar en los marcos
18200-..... y 19200-..... de 1 elemento

Marco tarjetero temporizado



BLANCO **18200** BEIGE **18200-A** DOR. ODISEA **18200-OD** ALUM. MERC. **18200-MA**

Marco tarjetero temporizado



BLANCO **19200** BEIGE **19200-A** DOR. ODISEA **19200-OD** ALUM. MERC. **19200-MA**

Envase 10

Envase 1



Interruptor temporizado electrónico regulable **2380**

230 V 50-60 Hz
Máx 1500 W incandescencia
800 fluorescencia
Regulable de 20s a 20 min.
Conexión 3 hilos
Para instalar en cajas de empalme o derivación

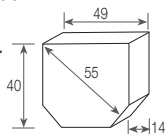

AURA BRILLO

NACAR



ACERO NEP.
18715-ANL



R. RUBI
18715-RRL



AZUL MING
18715-AML



V. MINERVA
18715-VML



COBRE JAIPUR
18715-CJL



DOR. ARENA
18715-DAL

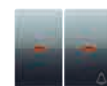

ACER. VOLCAN
18715-AVL



R. PROTEO
18715-RPL

Envase 20



NACAR BRILLANTE
18715-NBL

Envase 10



ACERO NEP.
18715-AN



R. RUBI
18715-RR



AZUL MING
18715-AM



V. MINERVA
18715-VM



COBRE JAIPUR
18715-CJ



DOR. ARENA
18715-DA



ACER. VOLCAN
18715-AV



R. PROTEO
18715-RP

Envase 20



NACAR BRILLANTE
18715-NB

Envase 10



ACERO NEP.
18068-AN



R. RUBI
18068-RR



AZUL MING
18068-AM



V. MINERVA
18068-VM



COBRE JAIPUR
18068-CJ



DOR. ARENA
18068-DA



ACER. VOLCAN
18068-AV



R. PROTEO
18068-RP

Envase 10



NACAR BRILLANTE
18068-NB

Envase 10



ACERO NEP.
18168-AN



R. RUBI
18168-RR



AZUL MING
18168-AM

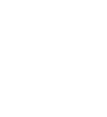

V. MINERVA
18168-VM



COBRE JAIPUR
18168-CJ



DOR. ARENA
18168-DA



ACER. VOLCAN
18168-AV



R. PROTEO
18168-RP

Envase 10



NACAR BRILLANTE
18168-NB

Envase 10



ACERO NEP.
18868-AN



R. RUBI
18868-RR



AZUL MING
18868-AM



V. MINERVA
18868-VM



COBRE JAIPUR
18868-CJ



DOR. ARENA
18868-DA



ACER. VOLCAN
18868-AV



R. PROTEO
18868-RP



NACAR BRILLANTE
18868-NB



ACERO NEP.
18200-AN



R. RUBI
18200-RR



AZUL MING
18200-AM



V. MINERVA
18200-VM



COBRE JAIPUR
18200-CJ



NACAR BRILLANTE
18200-NB



ACERO NEP.
19200-AN



DOR. ARENA
19200-DA



ACER. VOLCAN
19200-AV



R. PROTEO
19200-RP



NACAR BRILLANTE
19200-NB

Envase 1

**SISTEMA EUROPEO
MECANISMOS**



Pulsador
10 A 250 V~

Envase 10

18516

- 18716-L
- 18717-L
- 18718-L
- 18719-L
- 18720-L



- | | | | | |
|---------|----------|--------------|-------------|-------------|
| BLANCO | BEIGE | N. ANTRACITA | DOR. ODISEA | ALUM. MERC. |
| 18716-L | 18716-AL | 18716-ATL | 18716-ODL | 18716-MAL |
| 18717-L | 18717-AL | 18717-ATL | 18717-ODL | 18717-MAL |
| 18718-L | 18718-AL | 18718-ATL | 18718-ODL | 18718-MAL |
| 18719-L | 18719-AL | 18719-ATL | 18719-ODL | 18719-MAL |
| 18720-L | 18720-AL | 18720-ATL | 18720-ODL | 18720-MAL |



- 18716
- 18717
- 18718
- 18719
- 18720

- | | | | | |
|-------|---------|----------|----------|----------|
| 18716 | 18716-A | 18716-AT | 18716-OD | 18716-MA |
| 18717 | 18717-A | 18717-AT | 18717-OD | 18717-MA |
| 18718 | 18718-A | 18718-AT | 18718-OD | 18718-MA |
| 18719 | 18719-A | 18719-AT | 18719-OD | 18719-MA |
| 18720 | 18720-A | 18720-AT | 18720-OD | 18720-MA |

Tecla con difusor portaetiqueta

Para señalización luminosa añadir
señalizador Ref. 18039-1



- | | | | | |
|--------|---------|--------------|-------------|-------------|
| BLANCO | BEIGE | N. ANTRACITA | DOR. ODISEA | ALUM. MERC. |
| 18714 | 18714-A | 18714-AT | 18714-OD | 18714-MA |

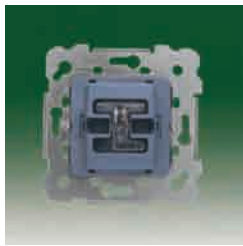

**Pulsador con interruptor
temporizado
con difusor luminoso**
Temporización 3 min.
Máx 500 W incandescencia 230 V~

Envase 10

18599

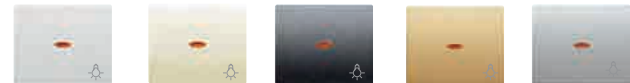

- | | | | | |
|---------|----------|--------------|-------------|-------------|
| BLANCO | BEIGE | N. ANTRACITA | DOR. ODISEA | ALUM. MERC. |
| 18717-L | 18717-AL | 18717-ATL | 18717-ODL | 18717-MAL |

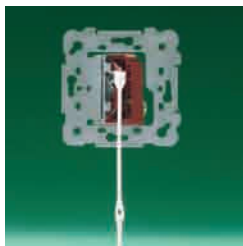

Pulsador de tirador
Conmutador de tirador
10 A 250 V~

No apto para garras

Envase 10

**18521
18598**



- | | | | | |
|--------|---------|--------------|-------------|-------------|
| BLANCO | BEIGE | N. ANTRACITA | DOR. ODISEA | ALUM. MERC. |
| 18734 | 18734-A | 18734-AT | 18734-OD | 18734-MA |

MECANISMOS PULSADORES



Pulsador desconexión
10 A 250 V~

Envase 10

18512



- | | | | | |
|--------|---------|--------------|-------------|-------------|
| BLANCO | BEIGE | N. ANTRACITA | DOR. ODISEA | ALUM. MERC. |
| 18712 | 18712-A | 18712-AT | 18712-OD | 18712-MA |



Doble pulsador desconexión
10 A 250 V~

Envase 10

18513



- | | | | | |
|--------|---------|--------------|-------------|-------------|
| BLANCO | BEIGE | N. ANTRACITA | DOR. ODISEA | ALUM. MERC. |
| 18709 | 18709-A | 18709-AT | 18709-OD | 18709-MA |

AURA BRILLO

NACAR

								Envase 20		Envase 10
ACERO NEP. 18716-ANL	R. RUBI 18716-RRL	AZUL MING 18716-AML	V. MINERVA 18716-VML	COBRE JAIPUR 18716-CJL	DOR. ARENA 18716-DAL	ACER. VOLCAN 18716-AVL	R. PROTEO 18716-RPL	Envase 20	NACAR BRILLANTE 18716-NBL	Envase 10
18717-ANL	18717-RRL	18717-AML	18717-VML	18717-CJL	18717-DAL	18717-AVL	18717-RPL	20	18717-NBL	10
18718-ANL	18718-RRL	18718-AML	18718-VML	18718-CJL	18718-DAL	18718-AVL	18718-RPL	20	18718-NBL	10
18719-ANL	18719-RRL	18719-AML	18719-VML	18719-CJL	18719-DAL	18719-AVL	18719-RPL	20	18719-NBL	10
18720-ANL	18720-RRL	18720-AML	18720-VML	18720-CJL	18720-DAL	18720-AVL	18720-RPL	20	18720-NBL	10

								20		10
18716-AN	18716-RR	18716-AM	18716-VM	18716-CJ	18716-DA	18716-AV	18716-RP	20	18716-NB	10
18717-AN	18717-RR	18717-AM	18717-VM	18717-CJ	18717-DA	18717-AV	18717-RP	20	18717-NB	10
18718-AN	18718-RR	18718-AM	18718-VM	18718-CJ	18718-DA	18718-AV	18718-RP	20	18718-NB	10
18719-AN	18719-RR	18719-AM	18719-VM	18719-CJ	18719-DA	18719-AV	18719-RP	20	18719-NB	10
18720-AN	18720-RR	18720-AM	18720-VM	18720-CJ	18720-DA	18720-AV	18720-RP	20	18720-NB	10

								Envase 20		Envase 10
ACERO NEP. 18714-AN	R. RUBI 18714-RR	AZUL MING 18714-AM	V. MINERVA 18714-VM	COBRE JAIPUR 18714-CJ	DOR. ARENA 18714-DA	ACER. VOLCAN 18714-AV	R. PROTEO 18714-RP	Envase 20	NACAR BRILLANTE 18714-NB	Envase 10

								Envase 20		Envase 10
ACERO NEP. 18717-ANL	R. RUBI 18717-RRL	AZUL MING 18717-AML	V. MINERVA 18717-VML	COBRE JAIPUR 18717-CJL	DOR. ARENA 18717-DAL	ACER. VOLCAN 18717-AVL	R. PROTEO 18717-RPL	Envase 20	NACAR BRILLANTE 18717-NBL	Envase 10

								Envase 10		Envase 10
ACERO NEP. 18734-AN	R. RUBI 18734-RR	AZUL MING 18734-AM	V. MINERVA 18734-VM	COBRE JAIPUR 18734-CJ	DOR. ARENA 18734-DA	ACER. VOLCAN 18734-AV	R. PROTEO 18734-RP	Envase 10	NACAR BRILLANTE 18734-NB	Envase 10

								Envase 20		Envase 10
ACERO NEP. 18712-AN	R. RUBI 18712-RR	AZUL MING 18712-AM	V. MINERVA 18712-VM	COBRE JAIPUR 18712-CJ	DOR. ARENA 18712-DA	ACER. VOLCAN 18712-AV	R. PROTEO 18712-RP	Envase 20	NACAR BRILLANTE 18712-NB	Envase 10

								Envase 20		Envase 10
ACERO NEP. 18709-AN	R. RUBI 18709-RR	AZUL MING 18709-AM	V. MINERVA 18709-VM	COBRE JAIPUR 18709-CJ	DOR. ARENA 18709-DA	ACER. VOLCAN 18709-AV	R. PROTEO 18709-RP	Envase 20	NACAR BRILLANTE 18709-NB	Envase 10

SISTEMA EUROPEO
MECANISMOS PULSADORES



Doble pulsador de persianas 18565

Enclavamiento eléctrico

Doble interruptor de persianas 18569

Enclavamiento eléctrico y mecánico
10 A 250 V~

Envase 10



Doble pulsador de persianas 18511

Requiere dispositivo auxiliar propio de cada fabricante de persiana.

Sin enclavamiento
10 A 250 V~

Envase 10

IRIS / AURA MATE / MAGNA



BLANCO
18765

BEIGE
18765-A

N. ANTRACITA
18765-AT

DOR. ODISEA
18765-OD

ALUM. MERC.
18765-MA



BLANCO
18711

BEIGE
18711-A

N. ANTRACITA
18711-AT

DOR. ODISEA
18711-OD

ALUM. MERC.
18711-MA

SEÑALIZADORES



Señalizador Luminoso 18039-1

230 V~

Señalizador luminoso para bipolar, unipolar y bipolar de control. (Tecla ancha)

Envase 20



Señalizador Luminoso 18039-2

230 V~

Señalizador luminoso para interruptor, conmutador, cruzamiento y pulsador. (Tecla ancha)

Envase 20

MECANISMOS CON LLAVE



Conmutador llave (extraíble) 18566

Conmutador llave (no extraíble) 18567

5 A 250 V~

Envase 1

Intensidad: 5 A (cos φ 0,7-1). Tensión 250 V. Contactos: 1 abierto 1 cerrado.
Terminales: plateados para soldar. Protección: IP 40.
Cumple norma VDE
Se suministran con 2 llaves.



BLANCO
18763

BEIGE
18763-A

N. ANTRACITA
18763-AT

DOR. ODISEA
18763-OD

ALUM. MERC.
18763-MA

REGULADOR DE INTENSIDAD LUMINOSA



Mecanismo regulador 21538

conmutador para incandescencia

No apto para fluorescencia

Envase 1

Cargas resistivas (lámparas incandescencia): 230 V-500 W
Cargas inductivas: lámparas halógenas muy baja tensión alimentadas con transformador electromagnético, 230 V-300 VA.
Este regulador incluye un fusible de protección Ref BJC. 2303
T: 2,5 A UNE EN 60127-2.
Reactancias recomendadas: ELT, OSRAM, PHILIPS o Equivalentes.
Este regulador no incluye la reactancia.



BLANCO
18748

BEIGE
18748-A

N. ANTRACITA
18748-AT

DOR. ODISEA
18748-OD

ALUM. MERC.
18748-MA



Mecanismo regulador 18548

para fluorescencia

Potenciómetro electrónico para usar conjuntamente con reactancias regulables con entrada de control de regulación 1 a 10 V ...

Cargas fluorescentes de 100 a 2500 W

Envase 1

AURA BRILLO

NACAR



ACERO NEP.
18765-AN



R. RUBI
18765-RR



AZUL MING
18765-AM



V. MINERVA
18765-VM



COBRE JAIPUR
18765-CJ



DOR. ARENA
18765-DA



ACER. VOLCAN
18765-AV



R. PROTEO
18765-RP

Envase
20



NACAR BRILLANTE
18765-NB

Envase
10



ACERO NEP.
18711-AN



R. RUBI
18711-RR



AZUL MING
18711-AM



V. MINERVA
18711-VM



COBRE JAIPUR
18711-CJ



DOR. ARENA
18711-DA



ACER. VOLCAN
18711-AV



R. PROTEO
18711-RP

Envase
20



NACAR BRILLANTE
18711-NB

Envase
10



Señalizador Luminoso 18039-3
230 V~

Señalizador luminoso para mecanismos.
(Tecla estrecha)

Envase 20



ACERO NEP.
18763-AN



R. RUBI
18763-RR



AZUL MING
18763-AM



V. MINERVA
18763-VM



COBRE JAIPUR
18763-CJ



DOR. ARENA
18763-DA



ACER. VOLCAN
18763-AV



R. PROTEO
18763-RP

Envase
10



NACAR BRILLANTE
18763-NB

Envase
10



ACERO NEP.
18748-AN



R. RUBI
18748-RR



AZUL MING
18748-AM



V. MINERVA
18748-VM



COBRE JAIPUR
18748-CJ



DOR. ARENA
18748-DA



ACER. VOLCAN
18748-AV



R. PROTEO
18748-RP

Envase
10



NACAR BRILLANTE
18748-NB

Envase
10

**SISTEMA EUROPEO
MECANISMOS ROTATIVOS**



Conmutador rotativo 18596
10 A 250 V~

Envase 1

4 posiciones, 3 circuitos.
Conexión por faston 6,3x0,8 mm.

IRIS / AURA MATE / MAGNA



BLANCO
18796



BEIGE
18796-A



N. ANTRACITA
18796-AT



DOR. ODISEA
18796-OD



ALUM. MERC.
18796-MA

BASES DE ENCHUFE



Base 2P normal 18522
16 A 250 V

Envase 10

SOLO PARA REPOSICION



BLANCO
18722



BEIGE
18722-A



N. ANTRACITA
18722-AT



DOR. ODISEA
18722-OD



ALUM. MERC.
18722-MA



Base enchufe 2P+T (TT lateral) 18523
16 A 250 V~

Envase 10

Con dispositivo de
seguridad incorporado
en tapa

Tapa articulada para
base 2P+T (TT lateral)
con seguridad

Identificación
circuitos especiales



BLANCO
18723



BEIGE
18723-A



N. ANTRACITA
18723-AT



DOR. ODISEA
18723-OD



ALUM. MERC.
18723-MA



BLANCO
18731



BEIGE
18731-A



N. ANTRACITA
18731-AT



DOR. ODISEA
18731-OD



ALUM. MERC.
18731-MA



BLANCO
18713



BEIGE
18713-A



N. ANTRACITA
18713-AT



DOR. ODISEA
18713-OD



ALUM. MERC.
18713-MA



18723-R

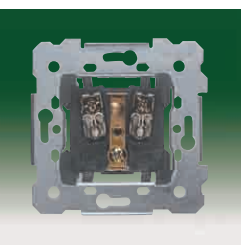

Base enchufe 2P+T (TT francés) 18571
16 A 250 V

Envase 10

Con dispositivo de
seguridad incorporado
en tapa



BLANCO
18771



BEIGE
18771-A



N. ANTRACITA
18771-AT



DOR. ODISEA
18771-OD



ALUM. MERC.
18771-MA

Base enchufe 2P + TT lateral
con marco Bjc Iris incorporado (Monoblock)
16 A 250 V~

Envase 10



BLANCO
18032



BEIGE
18032-A

AURA BRILLO

NACAR



ACERO NEP.
18796-AN



R. RUBI
18796-RR



AZUL MING
18796-AM



V. MINERVA
18796-VM



COBRE JAIPUR
18796-CJ



DOR. ARENA
18796-DA



ACER. VOLCAN
18796-AV



R. PROTEO
18796-RP

Envase
10



NACAR BRILLANTE
18796-NB

Envase
10



ACERO NEP.
18722-AN



R. RUBI
18722-RR



AZUL MING
18722-AM



V. MINERVA
18722-VM



COBRE JAIPUR
18722-CJ



DOR. ARENA
18722-DA



ACER. VOLCAN
18722-AV



R. PROTEO
18722-RP

Envase
10



NACAR BRILLANTE
18722-NB

Envase
10



ACERO NEP.
18723-AN



R. RUBI
18723-RR



AZUL MING
18723-AM



V. MINERVA
18723-VM



COBRE JAIPUR
18723-CJ



DOR. ARENA
18723-DA



ACER. VOLCAN
18723-AV



R. PROTEO
18723-RP

Envase
10



NACAR BRILLANTE
18723-NB

Envase
10



ACERO NEP.
18731-AN



R. RUBI
18731-RR



AZUL MING
18731-AM



V. MINERVA
18731-VM



COBRE JAIPUR
18731-CJ



DOR. ARENA
18731-DA



ACER. VOLCAN
18731-AV



R. PROTEO
18731-RP

Envase
10



NACAR BRILLANTE
18731-NB

Envase
10



ACERO NEP.
18713-AN



R. RUBI
18713-RR



AZUL MING
18713-AM



V. MINERVA
18713-VM



COBRE JAIPUR
18713-CJ



DOR. ARENA
18713-DA



ACER. VOLCAN
18713-AV



R. PROTEO
18713-RP

Envase
10



NACAR BRILLANTE
18713-NB

Envase
10

Envase
10



ACERO NEP.
18771-AN



R. RUBI
18771-RR

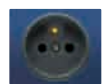

AZUL MING
18771-AM



V. MINERVA
18771-VM



COBRE JAIPUR
18771-CJ



DOR. ARENA
18771-DA



ACER. VOLCAN
18771-AV



R. PROTEO
18771-RP

Envase
10



NACAR BRILLANTE
18771-NB

Envase
10



**SISTEMA EUROPEO
MECANISMOS VARIOS**

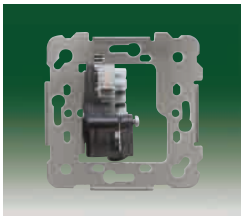

Salida de cables 18534
Con borne 3 x 1,5 mm²
Cable Ø máximo 10 mm

No apto garras

Envase 10



Color negro
Zumbador 230V~ 18535
Uso Intermitente

Zumbador regulador de tono
230V~ 50Hz 18536
Envase 10

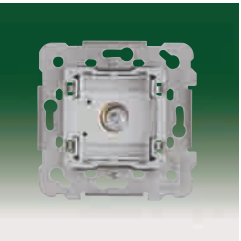

Piloto 18530
Incluye lamparita E-10 3 W 230 V~
Envase 10

Difusor Rojo	Difusor Ambar	Difusor Cristal	Difusor Verde
			
18630-R	18630-AB	18630-C	18630-V
Envase 10	Envase 10	Envase 10	Envase 10



Piloto de señalización de emergencia 18545
empotrables en caja universal con tornillos.
Características técnicas: 230 V~50Hz
Autonomía superior a 3 horas
Acumuladores Ni-Cd 1, 2 V- 300 m Ah
Posibilidad de control mediante telemando Ref.: MD-145.
Realizado según EN-60598-2-22 UNE 20062
No apto para garras
Envase 1

TOMAS PARA TV-FM-R/TV-SAT



Toma TV-FM
Serie 2-10 2932
Final serie 2933
Derivación única 2934
Vacia 2900
Envase 10

(Fabricante TELEVES)

Las tomas de señal para TV y FM cumplen con las normas UNE 20523 y CEI 16



Toma R/TV-SAT
Serie 6-12 2921
Serie 2-5 2922
Final serie 2923
Derivación única 2924
Envase 10

(Fabricante TELEVES)

Las tomas de señal para R/TV-SAT cumplen con las normas UNE 20523 y CEI 169-2.

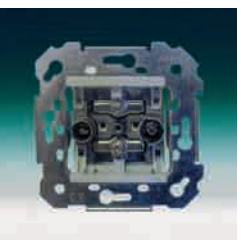

Toma R/TV-SAT modular
Única compatible 2935
Intermedia compatible 2936
Final compatible 2937

Envase 10

IRIS / AURA MATE / MAGNA



BLANCO
18734



BEIGE
18734-A



N. ANTRACITA
18734-AT



DOR. ODISEA
18734-OD



ALUM. MERC.
18734-MA

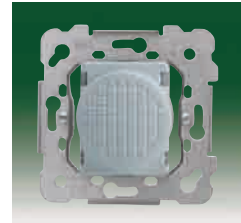

Color blanco
Zumbador 230V~ 18535-B
Uso Intermitente

Zumbador regulador de tono
230V~ 50Hz 18536-B
Envase 10

No apto garras



BLANCO
18730



BEIGE
18730-A



N. ANTRACITA
18730-AT



DOR. ODISEA
18730-OD



ALUM. MERC.
18730-MA

Tapas para Zumbador y Piloto



BLANCO
18330



BEIGE
18330-A



N. ANTRACITA
18330-AT



DOR. ODISEA
18330-OD



ALUM. MERC.
18330-MA



BLANCO
18320



BEIGE
18320-A



N. ANTRACITA
18320-AT



DOR. ODISEA
18320-OD



ALUM. MERC.
18320-MA



BLANCO
18320



BEIGE
18320-A



N. ANTRACITA
18320-AT



DOR. ODISEA
18320-OD



ALUM. MERC.
18320-MA

AURA BRILLO

NACAR



ACERO NEP.
18734-AN



R. RUBI
18734-RR



AZUL MING
18734-AM



V. MINERVA
18734-VM



COBRE JAIPUR
18734-CJ



DOR. ARENA
18734-DA



ACER. VOLCAN
18734-AV



R. PROTEO
18734-RP

Envase
10



NACAR BRILLANTE
18734-NB Envase
10

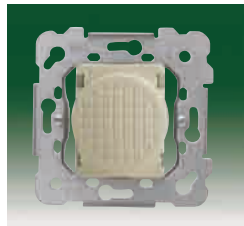

Color beige
Zumbador 230V~ 18535-A
Uso Intermitente

Zumbador regulador de tono
230V~ 50Hz 18536-A
Envase 10



ACERO NEP.
18730-AN



R. RUBI
18730-RR



AZUL MING
18730-AM



V. MINERVA
18730-VM



COBRE JAIPUR
18730-CJ



DOR. ARENA
18730-DA



ACER. VOLCAN
18730-AV



R. PROTEO
18730-RP

Envase
10



NACAR BRILLANTE
18730-NB Envase
10



Telemando MD-145
Realización de pruebas colectivas de funcionamiento en presencia de Red, a pilotos de señalización 18545. Puesta en estado de reposo de los mismos en ausencia de Red. Alimentación 230V 50-60 Hz. Batería de Ni-Cd recargable incorporada. Nº máx. de pilotos: 50. Instalación sobre perfil simétrico DIN 46277 (EN 60715). Dimensión: 4 módulos DIN de 17'5mm.

Envase 1



Lamparita recambio piloto 18040
sólo para 18530
E-10 3 W 230 V~
Incandescencia

Envase 10



ACERO NEP.
18330-AN



R. RUBI
18330-RR



AZUL MING
18330-AM



V. MINERVA
18330-VM



COBRE JAIPUR
18330-CJ



DOR. ARENA
18330-DA



ACER. VOLCAN
18330-AV



R. PROTEO
18330-RP

Envase
20



NACAR BRILLANTE
18330-NB Envase
10



ACERO NEP.
18320-AN



R. RUBI
18320-RR



AZUL MING
18320-AM



V. MINERVA
18320-VM



COBRE JAIPUR
18320-CJ



DOR. ARENA
18320-DA



ACER. VOLCAN
18320-AV



R. PROTEO
18320-RP

Envase
20



NACAR BRILLANTE
18320-NB Envase
10



ACERO NEP.
18320-AN



R. RUBI
18320-RR



AZUL MING
18320-AM



V. MINERVA
18320-VM



COBRE JAIPUR
18320-CJ



DOR. ARENA
18320-DA



ACER. VOLCAN
18320-AV



R. PROTEO
18320-RP

Envase
20



NACAR BRILLANTE
18320-NB Envase
10

SISTEMA EUROPEO

TOMAS PARA R/TV-SAT



Toma R/TV-SAT 3 Salidas
Toma derivación 2919
Toma serie o cascada 2920

(Fabricante IKUSI)

Envase 10

Las tomas de señal para R/TV-SAT cumplen con las normas UNE 20523 y CEI 169-2.

IRIS / AURA MATE / MAGNA



BLANCO
18340



BEIGE
18340-A



N. ANTRACITA
18340-AT



DOR. ODISEA
18340-OD



ALUM. MERC.
18340-MA

BALIZA DE EMERGENCIA



Baliza de emergencia extraíble 18584

Alimentación 230 V~ ±10%
50 ÷ 60 Hz

Autonomía linterna ≈ 3h ± 15

Tiempo de recarga de batería ≈ 12h

Envase 1



BLANCO
18784



BEIGE
18784-A



N. ANTRACITA
18784-AT



DOR. ODISEA
18784-OD



ALUM. MERC.
18784-MA

CONECTORES PARA BASES DE ACCESO
TERMINAL (BAT) Y PARA INFORMÁTICA SIN GARRAS

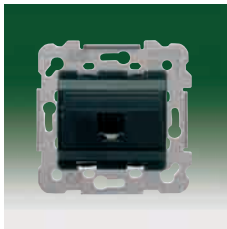

Toma teléfono conector hembra 6 vías RJ-11 para BAT en redes de telefonía básica 18582
Envase 10



Toma doble conector hembra 8 vías (ISO 8877) RJ-45 Cat. 5 E para BAT en redes digitales de servicios integrados (RDSI) y aplicaciones informáticas 18695
Envase 10



Toma doble teléfono conector hembra 6 vías RJ-11 para BAT en redes de telefonía básica 18682
Envase 10

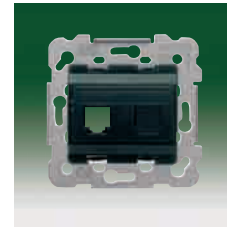

Tapa para adaptar dos conectores hembra 8 vías (ISO 8877) RJ-45 Cat. 5 E 18695-1
(AMP. ITT, INGES DATA, etc...)
Envase 10



Toma conector hembra 8 vías (ISO 8877) RJ-45 Cat. 5 E para BAT en redes digitales de servicios integrados (RDSI) y aplicaciones informáticas 18595
Envase 10



BLANCO
18782



BEIGE
18782-A



N. ANTRACITA
18782-AT



DOR. ODISEA
18782-OD



ALUM. MERC.
18782-MA

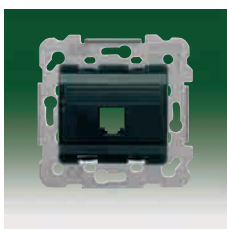

Tapa para adaptar un conector hembra 8 vías (ISO 8877) RJ-45 Cat. 5 E 18595-1
(AMP. ITT, INGES DATA, etc...)
Envase 10

AURA BRILLO

NACAR



ACERO NEP.
18340-AN



R. RUBI
18340-RR



AZUL MING
18340-AM

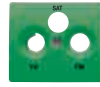

V. MINERVA
18340-VM

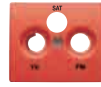

COBRE JAIPUR
18340-CJ

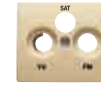

DOR. ARENA
18340-DA



ACER. VOLCAN
18340-AV



R. PROTEO
18340-RP

Envase
20



NACAR BRILLANTE
18340-NB

Envase
10



ACERO NEP.
18784-AN



R. RUBI
18784-RR



AZUL MING
18784-AM



V. MINERVA
18784-VM



COBRE JAIPUR
18784-CJ



DOR. ARENA
18784-DA



ACER. VOLCAN
18784-AV



R. PROTEO
18784-RP

Envase
10



NACAR BRILLANTE
18784-NB

Envase
10



ACERO NEP.
18782-AN



R. RUBI
18782-RR



AZUL MING
18782-AM



V. MINERVA
18782-VM



COBRE JAIPUR
18782-CJ



DOR. ARENA
18782-DA



ACER. VOLCAN
18782-AV



R. PROTEO
18782-RP

Envase
10



NACAR BRILLANTE
18782-NB

Envase
10



SISTEMA EUROPEO

CONECTORES PARA BASES DE ACCESO
TERMINAL (BAT) Y PARA INFORMÁTICA CON GARRAS

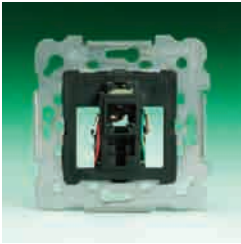

Toma teléfono 18482
6 vías RJ11 para
BAT en redes de telefonía básica.
(emborne por tornillos)

Envase 10

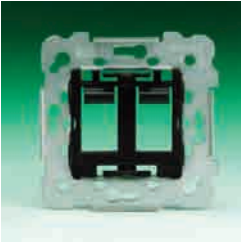

Adaptador para 2 19682-1
conectores RJ45 / RJ-11
(AMP, AMP con tapita guardapolvo,
ITT, INGESDATA, etc...)

Envase 10

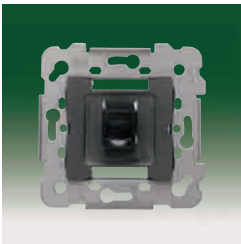

Toma teléfono conector 19582
hembra 6 vías RJ-11
para BAT en redes de
telefonía básica
(emborne por perforación aislante)

Envase 10

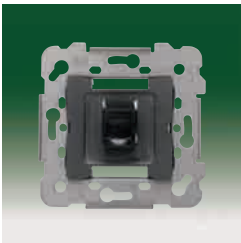

Toma conector hembra 8 vías 19595
(ISO 8877) RJ-45 Cat. 5 E para
BAT en redes digitales de
servicios integrados (RDSI) y aplicaciones
informáticas
(emborne por perforación aislante)

Envase 10

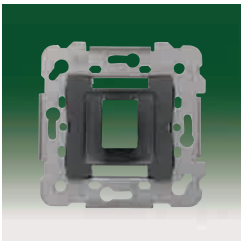

Adaptador para 1 19582-1
conector RJ45 / RJ-11
(AMP, AMP con tapita guardapolvo,
ITT, INGESDATA, etc...)

Envase 10

CONECTOR MÚLTIPLE

Base múltiple para conectores 18049
informáticos con portaetiquetas
Incluye 5 adaptadores para diferentes conectores

IRIS / AURA MATE / MAGNA



BLANCO
18882



BEIGE
18882-A



N. ANTRACITA
18882-AT



DOR. ODISEA
18882-OD



ALUM. MERC.
18882-MA



BLANCO
19882



BEIGE
19882-A



N. ANTRACITA
19882-AT



DOR. ODISEA
19882-OD



ALUM. MERC.
19882-MA



BLANCO
19883



BEIGE
19883-A



N. ANTRACITA
19883-AT



DOR. ODISEA
19883-OD



ALUM. MERC.
19883-MA



BLANCO
19782



BEIGE
19782-A



N. ANTRACITA
19782-AT



DOR. ODISEA
19782-OD



ALUM. MERC.
19782-MA



BLANCO
19783



BEIGE
19783-A

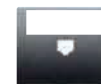

N. ANTRACITA
19783-AT



DOR. ODISEA
19783-OD



ALUM. MERC.
19783-MA



BLANCO
18049



BEIGE
18049-A



N. ANTRACITA
18049-AT



DOR. ODISEA
18049-OD



ALUM. MERC.
18049-MA

Adaptadores incluidos



Conector
SUB-D 9 Pins



Conector
SUB-D 15 Pins



Conector
Ciego



Soporte
Toma RJ-45



Conector
Twinaxial

AURA BRILLO

NACAR



ACERO NEP.
18882-AN



R. RUBI
18882-RR



AZUL MING
18882-AM



V. MINERVA
18882-VM



COBRE JAIPUR
18882-CJ



DOR. ARENA
18882-DA



ACER. VOLCAN
18882-AV



R. PROTEO
18882-RP

Envase
10



NACAR BRILLANTE
18882-NB

Envase
10



ACERO NEP.
19882-AN



R. RUBI
19882-RR



AZUL MING
19882-AM



V. MINERVA
19882-VM



COBRE JAIPUR
19882-CJ



DOR. ARENA
19882-DA



ACER. VOLCAN
19882-AV



R. PROTEO
19882-RP

Envase
10



NACAR BRILLANTE
19882-NB

Envase
10



ACERO NEP.
19883-AN



R. RUBI
19883-RR



AZUL MING
19883-AM



V. MINERVA
19883-VM



COBRE JAIPUR
19883-CJ



DOR. ARENA
19883-DA



ACER. VOLCAN
19883-AV



R. PROTEO
19883-RP

Envase
10



NACAR BRILLANTE
19883-NB

Envase
10



ACERO NEP.
19782-AN



R. RUBI
19782-RR



AZUL MING
19782-AM



V. MINERVA
19782-VM



COBRE JAIPUR
19782-CJ



DOR. ARENA
19782-DA



ACER. VOLCAN
19782-AV



R. PROTEO
19782-RP

Envase
10



NACAR BRILLANTE
19782-NB

Envase
10

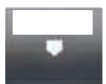

ACERO NEP.
19783-AN



R. RUBI
19783-RR



AZUL MING
19783-AM



V. MINERVA
19783-VM



COBRE JAIPUR
19783-CJ



DOR. ARENA
19783-DA



ACER. VOLCAN
19783-AV



R. PROTEO
19783-RP

Envase
10



NACAR BRILLANTE
19783-NB

Envase
10

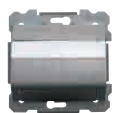

ACERO NEP.
18049-AN



R. RUBI
18049-RR



AZUL MING
18049-AM



V. MINERVA
18049-VM



COBRE JAIPUR
18049-CJ



DOR. ARENA
18049-DA



ACER. VOLCAN
18049-AV



R. PROTEO
18049-RP

Envase
10



NACAR BRILLANTE
18049-NB

Envase
10



SISTEMA EUROPEO CONECTORES



Conector RJ11 Cat.3 6 vías
Contactos tubulares, posible
conexión 2 cables en el mismo
contacto

Negro 3173-N
Envase 40



Conector modular RJ45 Cat.5E
8 vías. Conexionado sin herramienta

Blanco 3175-B
Negro 3175-N
Envase 25



Conector modular RJ11 Cat.3
6 vías. Conexionado sin
herramienta

Blanco 3174-B
Negro 3174-N
Envase 25



Conector modular RJ 45
Cat 5E 8 vías
Conexionado sin herramienta
Apantallado

3176
Envase 25

TOMAS DE TELEFONO

Toma teléfono Francés

IRIS / AURA MATE / MAGNA



BLANCO
18080



BEIGE
18080-A



N. ANTRACITA
18080-AT



DOR. ODISEA
18080-OD



ALUM. MERC.
18080-MA

POTENCIOMETRO BOBINADO PARA ALTAVOCES



Potenciometro 3W - 27 Ω 18560
Potenciometro 5W - 47 Ω 18562
*Potenciometro 5+5W - 47 Ω 18564

*Necesita caja de empotrar 2364

No apto para garras

Envase 1



BLANCO
18760



BEIGE
18760-A



N. ANTRACITA
18760-AT



DOR. ODISEA
18760-OD



ALUM. MERC.
18760-MA

TOMA ALTAVOCES

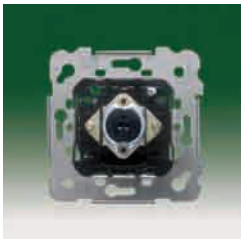

Toma altavoz DIN 18563

Envase 10



BLANCO
18763



BEIGE
18763-A



N. ANTRACITA
18763-AT



DOR. ODISEA
18763-OD



ALUM. MERC.
18763-MA



Toma altavoz (mono) 18563-2

Envase 1



BLANCO
18863



BEIGE
18863-A



N. ANTRACITA
18863-AT



DOR. ODISEA
18863-OD



ALUM. MERC.
18863-MA



Toma altavoz (estéreo) 18563-4

Envase 1



Conector modular RJ45
Cat. 5E 8 vías
Conexionado sin herramienta
Tapita guardapolvo

Blanco 3177-B
Negro 3177-N
Envase 25



Conector modular RJ45
Cat. 6 8 vías
Apantallado

Envase 25 3179



Conector modular RJ45 Cat.6
8 vías.

Blanco 3178-B
Negro 3178-N
Envase 25

HERRAMIENTAS



Herramienta conexión
RJ45 Cat.6
3180
Envase 1



Herramienta conexión
RJ11 y RJ45
3181
Envase 1

AURA BRILLO



ACERO NEP.
18080-AN



R. RUBI
18080-RR

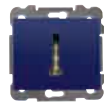

AZUL MING
18080-AM

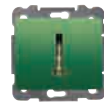

V. MINERVA
18080-VM



COBRE JAIPUR
18080-CJ



DOR. ARENA
18080-DA

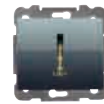

ACER. VOLCAN
18080-AV



R. PROTEO
18080-RP

Envase 10



NACAR BRILLANTE
18080-NB Envase 10



ACERO NEP.
18760-AN



R. RUBI
18760-RR



AZUL MING
18760-AM



V. MINERVA
18760-VM



COBRE JAIPUR
18760-CJ



DOR. ARENA
18760-DA



ACER. VOLCAN
18760-AV



R. PROTEO
18760-RP

Envase 10



NACAR BRILLANTE
18760-NB Envase 10



ACERO NEP.
18763-AN



R. RUBI
18763-RR



AZUL MING
18763-AM



V. MINERVA
18763-VM



COBRE JAIPUR
18763-CJ



DOR. ARENA
18763-DA



ACER. VOLCAN
18763-AV



R. PROTEO
18763-RP

Envase 10



NACAR BRILLANTE
18763-NB Envase 10



ACERO NEP.
18863-AN



R. RUBI
18863-RR



AZUL MING
18863-AM



V. MINERVA
18863-VM



COBRE JAIPUR
18863-CJ



DOR. ARENA
18863-DA



ACER. VOLCAN
18863-AV



R. PROTEO
18863-RP

Envase 10



NACAR BRILLANTE
18863-NB Envase 10



SISTEMA EUROPEO

TOMAS DE ALTAVOZ



Toma Mono RCA

18575

Envase 1

IRIS / AURA MATE / MAGNA



BLANCO
18882



BEIGE
18882-A



N. ANTRACITA
18882-AT



DOR. ODISEA
18882-OD



ALUM. MERC.
18882-MA

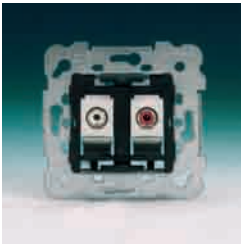

Toma Stereo RCA

18576

Envase 1



BLANCO
18776



BEIGE
18776-A



N. ANTRACITA
18776-AT



DOR. ODISEA
18776-OD



ALUM. MERC.
18776-MA

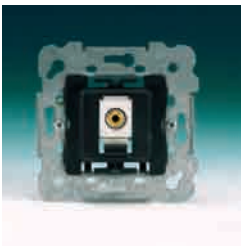

Toma Video RCA

18577

Envase 1



BLANCO
18882



BEIGE
18882-A



N. ANTRACITA
18882-AT



DOR. ODISEA
18882-OD



ALUM. MERC.
18882-MA

CRONOTERMOSTATO



Cronotermostato
Para caja universal Ø 60

Blanco 2381-B

Envase 1

Contacto: Contacto inversor, sin potencial, tensión baja de protección.

Máx. 5 A / 250 V~, min. 1mA/5 V.

Precisión: ± 1 s al día con 20°C.

Precisión de regulación: ± 0,2 K.

Alcance de medición de temperatura: de 0°C a 50°C, resolución 0,1°C.

Margen de ajuste para temperatura: de 6°C a 30°C en pasos de 0,2°C.

Espacios de memoria: 22 cambios de temperatura, programables para lunes a viernes, sábado/domingo, cada día o para días individuales.

Clase de protección: II conforme a EN 60730-1.

Modo de protección: IP 20 conforme a EN 60529-1

Se suministra sin pilas

2 pilas 1,5V AAA - LR03

*Bajo demanda se puede pedir en cualquier color de la serie.

AURA BRILLO

NACAR



ACERO NEP.
18882-AN



R. RUBI
18882-RR



AZUL MING
18882-AM



V. MINERVA
18882-VM



COBRE JAIPUR
18882-CJ



DOR. ARENA
18882-DA



ACER. VOLCAN
18882-AV



R. PROTEO
18882-RP

Envase
10



NACAR BRILLANTE
18882-NB

Envase
10



ACERO NEP.
18776-AN



R. RUBI
18776-RR



AZUL MING
18776-AM



V. MINERVA
18776-VM



COBRE JAIPUR
18776-CJ



DOR. ARENA
18776-DA



ACER. VOLCAN
18776-AV



R. PROTEO
18776-RP

Envase
10



NACAR BRILLANTE
18776-NB

Envase
10



ACERO NEP.
18882-AN



R. RUBI
18882-RR



AZUL MING
18882-AM



V. MINERVA
18882-VM



COBRE JAIPUR
18882-CJ



DOR. ARENA
18882-DA



ACER. VOLCAN
18882-AV



R. PROTEO
18882-RP

Envase
10



NACAR BRILLANTE
18882-NB

Envase
10

MECANISMOS VARIOS

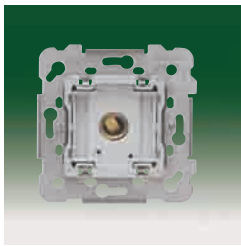

Cortacircuito
16 A 250 V~ **18528**

Para fusible cerámico 8,5x31,5 mm
Envase 10



BLANCO
18728



BEIGE
18728-A



N. ANTRACITA
18728-AT



DOR. ODISEA
18728-OD



ALUM. MERC.
18728-MA

Tapón portafusible
Recambio para artículo Ref. 18528



BLANCO
18029



BEIGE
18029-A



N. ANTRACITA
18029-AT



DOR. ODISEA
18029-OD



ALUM. MERC.
18029-MA

Tapa ciega



BLANCO
18033



BEIGE
18033-A



N. ANTRACITA
18033-AT



DOR. ODISEA
18033-OD



ALUM. MERC.
18033-MA

TERMOSTATOS AMBIENTE

Termostato para calefacción y ventilación con interruptor, 5A(2A) 230~ regulación 5 a 30° C.
(reducción nocturna: el termostato incorpora una segunda resistencia que, a través de un interruptor horario, puede alimentarse a determinadas horas consiguiéndose una reducción de la temperatura de 5° C).
Envase 1



BLANCO
18144



BEIGE
18144-A



N. ANTRACITA
18144-AT

Termostato de ambiente
Control de la temperatura del suelo en instalaciones de calefacción por suelo radiante.
Reducción nocturna mediante la señal de programador externo. Indicador luminoso "Calefacción conectada" y "funcionamiento reducido". Interruptor marcha-paro. Montaje en caja de mecanismos de 60 mm. Indicadores luminosos.
Temperatura: *...5 [=10...50°C]
Alimentación: 230 V AC [195...253V] 50 Hz
Sonda remota: [long. 4m. prolongable a 50m.]
Temperatura de ambiente 0...40°C



BLANCO
18244



BEIGE
18244-A



N. ANTRACITA
18244-AT

Envase 1



Termostato electrónico para calefacción o ventilación.
230 V~/ 1900W cos φ=1
230 V~/ 450W cos φ=0,6
Regulación de 5° C a 30° C **18544**

Envase 1



BLANCO
18744



BEIGE
18744-A



N. ANTRACITA
18744-AT



DOR. ODISEA
18744-OD



ALUM. MERC.
18744-MA



ACERO NEP.
18728-AN



R. RUBI
18728-RR



AZUL MING
18728-AM



V. MINERVA
18728-VM



COBRE JAIPUR
18728-CJ



DOR. ARENA
18728-DA



ACER. VOLCAN
18728-AV



R. PROTEO
18728-RP

Envase
10



NACAR BRILLANTE
18728-NB

Envase
10



ACERO NEP.
18029-AN



R. RUBI
18029-RR



AZUL MING
18029-AM



V. MINERVA
18029-VM



COBRE JAIPUR
18029-CJ



DOR. ARENA
18029-DA



ACER. VOLCAN
18029-AV



R. PROTEO
18029-RP

Envase
10



NACAR BRILLANTE
18029-NB

Envase
10



ACERO NEP.
18033-AN



R. RUBI
18033-RR

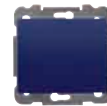

AZUL MING
18033-AM



V. MINERVA
18033-VM



COBRE JAIPUR
18033-CJ



DOR. ARENA
18033-DA



ACER. VOLCAN
18033-AV



R. PROTEO
18033-RP

Envase
10



NACAR BRILLANTE
18033-NB

Envase
10



ACERO NEP.
18744-AN



R. RUBI
18744-RR



AZUL MING
18744-AM



V. MINERVA
18744-VM



COBRE JAIPUR
18744-CJ



DOR. ARENA
18744-DA



ACER. VOLCAN
18744-AV



R. PROTEO
18744-RP

Envase
1



NACAR BRILLANTE
18744-NB

Envase
1

SISTEMA EUROPEO
RECEPTORES MANDO DISTANCIA

IRIS / AURA MATE / MAGNA



Interruptor infrarrojos hasta 500W **18554**
230V~ 50/60 Hz máx. 500VA $\cos\varphi = 0,65$
Para lámparas incandescencia con o sin transformador electromagnético
Accionamiento con mando 18148

Envase 1



Interruptor infrarrojos hasta 1500W **18556**
230V~ 50/60 Hz
• máx. 1500W carga resistiva
• máx. 1000VA carga fluorescentes sin compensar
• máx. 500VA carga fluorescentes compensada (100 μ F)
• máx. 500VA carga halógenas con transformador electromagnético
Accionamiento con mando 18148

Envase 1



Regulador infrarrojos **18553**
230V~ / 50-60 Hz de 50 a 500VA
 $\cos\varphi = 0,65$
Accionamiento con mando 18148

Envase 1



BLANCO
18746



BEIGE
18746-A



N. ANTRACITA
18746-AT



DOR. ODISEA
18746-OD



ALUM. MERC.
18746-MA



Interruptor de infrarrojos para persianas **18557**
Alimentación: 212-254V~50/60Hz
Control: 2 relés con enclavamiento eléctrico
1500W máx. resistiva pura 500VA máx. inductiva ($\cos\varphi: 0,4$)
Actuación remota: Mediante mando IR (ref. 18148) ó pulsadores con contacto normalmente abierto (ref. 18511)

Envase 1

RELOJ DIGITAL



Reloj despertador con termómetro **18546**
230 V~/ 50-60 Hz
Indicación horas y minutos 24h.
Despertador 2 alarmas, 10 melodías
Termómetro: indicación en $^{\circ}$ C y $^{\circ}$ F

Envase 1

MANDO A DISTANCIA



Mando a distancia (infrarrojos) **18148**
Alimentación: 2 pilas 1,5 V AAA (R06) alcalinas
Consumo: 5mA máx. Alcance: 8 m
15 teclas para gobernar hasta 9 receptores infrarrojos por habitación, con 3 funciones adicionales y 3 teclas de pulsación simultánea.

Envase 1



ACERO NEP.
18746-AN



R. RUBI
18746-RR



AZUL MING
18746-AM



V. MINERVA
18746-VM



COBRE JAIPUR
18746-CJ



DOR. ARENA
18746-DA



ACER. VOLCAN
18746-AV



R. PROTEO
18746-RP

Envase
1



NACAR BRILLANTE
18746-NB

Envase
1



**SISTEMA EUROPEO
DETECTOR DE PRESENCIA**



Detector de presencia Iris 18052
 Ángulo detección 195°
 Montaje individual (marco incluido)
 (sólo en blanco)
 Interruptor detector de movimiento
 Tiempo ajustable entre 6 segundos y 12 minutos rearmable por un movimiento de la fuente de calor
 Alimentación 230V~ 50 Hz
 Ángulo de detección horizontal 195°
 Alcance 8 m máximo, regulable
 Regulación de nivel luminoso entre 5 y 10.000 lx
 Cargas: 1.600W incandescencia
 400W fluorescencia /400W halógenas baja tensión

Envase 1



Detector de presencia Aura 19052
 Ángulo detección 195°
 Montaje individual (marco incluido)
 (sólo en blanco)
 Interruptor detector de movimiento
 Tiempo ajustable entre 6 segundos y 12 minutos rearmable por un movimiento de la fuente de calor
 Alimentación 230V~ 50 Hz
 Ángulo de detección horizontal 195°
 Alcance 8 m máximo, regulable
 Regulación de nivel luminoso entre 5 y 10.000 lx
 Cargas: 1.600W incandescencia
 400W fluorescencia /400W halógenas baja tensión

Envase 1

IRIS / AURA MATE / MAGNA

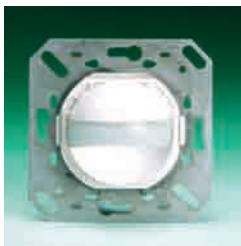

Detector de presencia esférico 18555
 No apto para garras
 Ángulo detección 180° horizontal/60° vertical
 Temporización de 4 seg. a 10 min.
 Alimentación 230 V +6% / -10%
 Alcance (1,2-2,2 mts. de altura de montaje) max. 8 mts. para movimiento lateral aprox. 3 mts. para movimiento frontal.
 Nivel crepuscular de 5 a 1000 Lux.
 Capacidad de contacto (2 hilos, salida triac):
 - Incandescente/halógenas 40 - 300 W max.

Envase 1



BLANCO
18730

BEIGE
18730-A

N. ANTRACITA
18730-AT

DOR. ODISEA
18730-OD

ALUM. MERC.
18730-MA

**Detector de presencia esférico 18555-3
mecanismo 3 hilos**
 Capacidad de contacto (2 hilos, salida relé):
 Carga resistiva 2.300W, 10 A máx , cos φ=1
 Carga inductiva 1.500W, 5 A máx , cos φ=0,6
 Halógenas con transformador 1000VA
 Balastos electrónicos ej. 25x36W (140 máx.)
 Envase 1

KIT DE SONIDO K23



BJC IRIS



BJC AURA

Kit de sintonización empotrable

K-23

Receptor de radio FM
 Alimentación 230V
 Búsqueda automática de emisoras
 Presintonía
 Salida de auriculares (jack 3,5 mm)
 Consta de dos módulos: Altavoz-transformador y receptor FM
 88 MHz - 108 MHz
 Instalar con 2 adaptadores ref. 18742 y marcos de 2 elementos
(SE SUMINISTRAN APARTE).
 Con bastidor metálico.
 Cada Kit incluye 3 tapas para cada módulo en:
 blanco, beige y antracita.

Envase 1

ALT-1

Altavoz auxiliar para K-23.
 Permite disponer de otro altavoz a un máximo de 15 metros del receptor.
 8 Ω 1W

AURA BRILLO

NACAR



ACERO NEP.
18730-AN



R. RUBI
18730-RR



AZUL MING
18730-AM



V. MINERVA
18730-VM



COBRE JAIPUR
18730-CJ



DOR. ARENA
18730-DA



ACER. VOLCAN
18730-AV



R. PROTEO
18730-RP

Envase
10



NACAR BRILLANTE
18730-NB

Envase
10



BJC MAGNA

SONIDO

**Adaptador para sonido
(Sonelco, Eis, Tez, Sonbel)**
 Según el fabricante debe añadirse
 su bastidor correspondiente:
 Sonelco: PC 9120
 EIS 14401 (combina sólo en color blanco)
 TEZ: Tx41/Bl
 Tx41/Mf

☑ 46 x 46 mm

IRIS / AURA MATE / MAGNA



BLANCO
18742



BEIGE
18742-A



N. ANTRACITA
18742-AT



DOR. ODISEA
18742-OD



ALUM. MERC.
18742-MA

Adaptador para sonido EGI
 Adaptación directa a los bastidores
 de los módulos de sonido

☑ 41 x 41 mm



BLANCO
18743



BEIGE
18743-A



N. ANTRACITA
18743-AT



DOR. ODISEA
18743-OD



ALUM. MERC.
18743-MA

AURA BRILLO

NACAR



ACERO NEP.
18742-AN



R. RUBI
18742-RR



AZUL MING
18742-AM



V. MINERVA
18742-VM



COBRE JAIPUR
18742-CJ



DOR. ARENA
18742-DA



ACER. VOLCAN
18742-AV



R. PROTEO
18742-RP

Envase
10



NACAR BRILLANTE
18742-NB

Envase
10



ACERO NEP.
18743-AN



R. RUBI
18743-RR



AZUL MING
18743-AM



V. MINERVA
18743-VM



COBRE JAIPUR
18743-CJ



DOR. ARENA
18743-DA



ACER. VOLCAN
18743-AV



R. PROTEO
18743-RP

Envase
10



NACAR BRILLANTE
18743-NB

Envase
10

ADAPTACIÓN MODULOS DE SONIDO

FABRICANTE

EGI

Electroacústica General Ibérica
Tel.: 976 405353
Zaragoza

EIS

Electrónica Integral de Sonido, S.A.
Tel.: 976 465550
Zaragoza

SONELCO

Sonido, Electrónica y Comunicación, S.A.
Tel.: 976 259125
Zaragoza

TEZ

Sistemas de sonorización TEZ, S.L.
Tel.: 976 570211
Zaragoza

SONBEL

Sonbel Electrónica S.A.
Tel.: 976 126812
Zaragoza

ADAPTACIÓN IRIS / AURA

Utilizar:

Adaptador BJC 18743-...

Utilizar:

Adaptador BJC 18742-...
Bastidor EIS 14401

Utilizar:

Adaptador BJC 18742
Bastidor SONELCO PC 9120

Utilizar:

Adaptador BJC 18742-...
Adaptador + Bastidor TEZ TX41/BI (Blanco)
TX41/Mf (Marfil)

Utilizar:

Adaptador BJC 18742-...

ARTICULOS MONTADOS



Interruptor Unipolar
Conmutador

16 A 250 V~

Envase 10

18905

18905-A

18906

18906-A



Doble Interruptor
16 A 250 V~

Envase 10

18909

18909-A



Base de enchufe
16 A 250 V~

Envase 10

18923

18923-A

**CAJA UNIVERSAL ENLAZABLE
CON TORNILLOS 60 mm**



Universal enlazable 2373

Material termoplástico
Envase 500



Tapa protección 2374

Permite localizar la caja después de enlucir
Envase 100



**18-GAR
Para bastidores metálicos**

Bolsa con 50 garras y
50 tornillos
para montar 25 bastidores.

**CAJA UNIVERSAL ENLAZABLE
CON TORNILLOS Ø 60 mm**



Simple 2323

Material termoplástico
Envase 75

Doble 2360

Material termoplástico
Envase 25

Triple 2361

Material termoplástico
Envase 5



Para instalar mecanismos
que precisen mayor
profundidad **2364**

Indicada para artículo Ref. 10564
Envase 10

CAJAS DE EMPOTRAR PARA PANELES



Simple 2377

Material termoplástico
Envase 50

Doble 2378

Material termoplástico
Envase 20

CAJA DE EMPOTRAR PARA PANTALLA TÁCTIL



Caja para pantalla táctil 2379

Envase 1

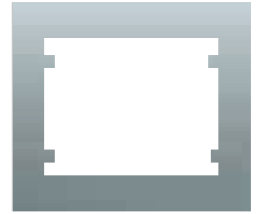
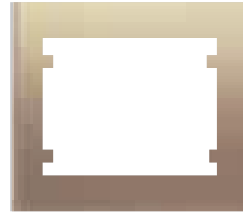

BLANCO		Env
	18001	10
	18002	10
	18003	5
	18004	5
	18005	5
	18102	10
	18103	5
	18104	5

BEIGE		Env
	18001-A	10
	18002-A	10
	18003-A	5
	18004-A	5
	18005-A	5
	18102-A	10
	18103-A	5
	18104-A	5

DORADO		Env
	18001-OD	10
	18002-OD	10
	18003-OD	5
	18004-OD	5
	18005-OD	5
	18102-OD	10
	18103-OD	5
	18104-OD	5

ALUMINIO		Env
	18001-MA	10
	18002-MA	10
	18003-MA	5
	18004-MA	5
	18005-MA	5
	18102-MA	10
	18103-MA	5
	18104-MA	5

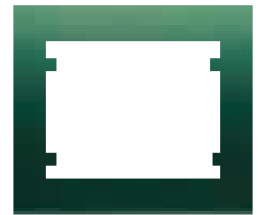
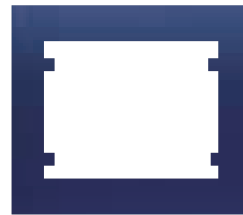
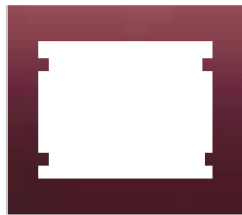
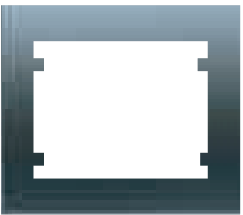

ACERO		Env
	18001-AN	10
	18002-AN	10
	18003-AN	5
	18004-AN	5
	18005-AN	5
	18102-AN	10
	18103-AN	5
	18104-AN	5

ROJO RUBI		Env
	18001-RR	10
	18002-RR	10
	18003-RR	5
	18004-RR	5
	18005-RR	5
	18102-RR	10
	18103-RR	5
	18104-RR	5

AZUL MING		Env
	18001-AM	10
	18002-AM	10
	18003-AM	5
	18004-AM	5
	18005-AM	5
	18102-AM	10
	18103-AM	5
	18104-AM	5

VERDE		Env
	18001-VM	10
	18002-VM	10
	18003-VM	5
	18004-VM	5
	18005-VM	5
	18102-VM	10
	18103-VM	5
	18104-VM	5

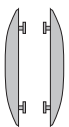

(2 unid) para marcos de posición horizontal (opcional)
Envase 10



ORO BRILLO
18600-OR



ORO MATE
18600-ORM



NIQUEL BRILLO
18600-NI











NIQUEL MATE
18600-NIM



COBRE









JAIPUR Env

	18001-CJ	10
	18002-CJ	10
	18003-CJ	5
	18004-CJ	5
	18005-CJ	5
	18102-CJ	10
	18103-CJ	5
	18104-CJ	5



NACAR





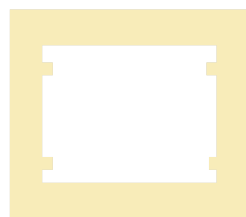



BRILLANTE Env

	18001-NB	10
	18002-NB	10
	18003-NB	5
	18004-NB	5
	18005-NB	5
	18102-NB	10
	18103-NB	5
	18104-NB	5



AMARILLO









VAINILLA Env

	18001-VA	10
	18002-VA	10
	18003-VA	5
	18004-VA	5
	18005-VA	5
	18102-VA	10
	18103-VA	5
	18104-VA	5



ALUMINIO









MERCURIO Env

	18001-LA	10
	18002-LA	10
	18003-LA	5
	18004-LA	5
	18005-LA	5
	18102-LA	10
	18103-LA	5
	18104-LA	5



VERDE









MENTA Env

	18001-MV	10
	18002-MV	10
	18003-MV	5
	18004-MV	5
	18005-MV	5
	18102-MV	10
	18103-MV	5
	18104-MV	5



HAYA









HAYA Env









	18001-HY	10
	18002-HY	10
	18003-HY	5
	18004-HY	5
	18005-HY	5
	18102-HY	10
	18103-HY	5
	18104-HY	5



COBRE

GRANITO Env

	18001-GT	10
	18002-GT	10
	18003-GT	5
	18004-GT	5
	18005-GT	5
	18102-GT	10
	18103-GT	5
	18104-GT	5

	85 x 84 mm
	85 x 155 mm
	85 x 226 mm
	85 x 298 mm
	85 x 370 mm
	156 x 84 mm
	228 x 84 mm
	299 x 84 mm

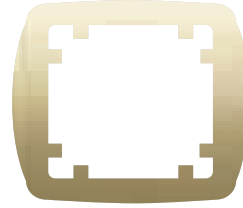
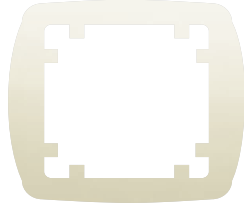
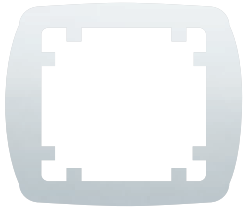

BLANCO		Env
	19001	10
	19002	10
	19003	5
	19004	5

BEIGE		Env
	19001-A	10
	19002-A	10
	19003-A	5
	19004-A	5

DORADO		Env
	19001-OD	10
	19002-OD	10
	19003-OD	5
	19004-OD	5

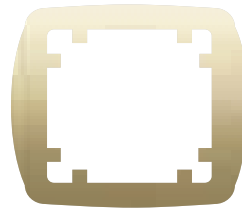
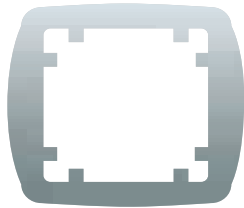
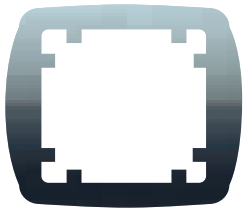

ALUMINIO		Env
	19001-AN	10
	19002-AN	10
	19003-AN	5
	19004-AN	5

ACERO		Env
	19001-MA	10
	19002-MA	10
	19003-MA	5
	19004-MA	5

DORADO		Env
	19001-DA	10
	19002-DA	10
	19003-DA	5
	19004-DA	5

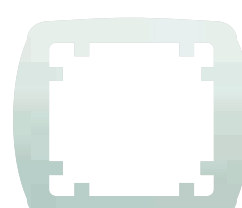
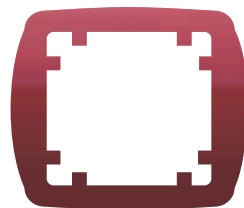
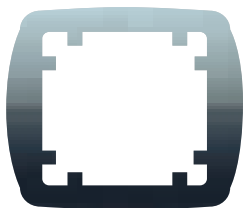

ACERO		Env
	19001-AV	10
	19002-AV	10
	19003-AV	5
	19004-AV	5

ROJO		Env
	19001-RP	10
	19002-RP	10
	19003-RP	5
	19004-RP	5

NACAR		Env
	19001-NB	10
	19002-NB	10
	19003-NB	5
	19004-NB	5

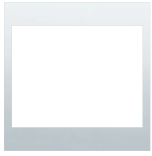

BLANCO Env.
19600 10

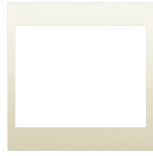

BEIGE Env.
19600-A 10



DORADO ARENA Env.
19600-DA 10



ACERO VOLCAN Env.
19600-AV 10

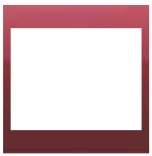

ROJO PROTEO Env.
19600-RP 10

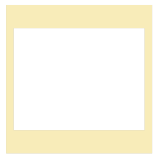

VAINILLA BRILLO Env.
19600-VB 10



MENTA BRILLO Env.
19600-MB 10

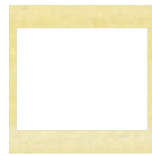

ORO BRILLO Env.
19600-OR 10



ORO MATE Env.
19600-ORM 10

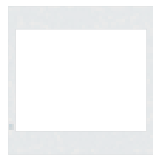

NIQUEL BRILLO Env.
19600-NI 10



NIQUEL MATE Env.
19600-NIM 10

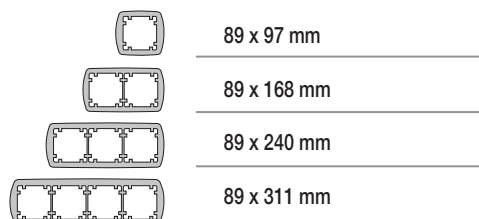

bjc Magna



NEGRO BRILLO

AZUL BRILLO

BLANCO SATINADO



Marco 1 elemento horizontal/vertical
115x115 mm.

Intermedio
Aluminio

19501-NS

19501-AS

19501-BS

Envase 1

Intermedio
Acero

19501-NSN

19501-ASN

19501-BSN

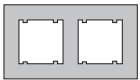

Marco 2 elementos horizontal
186x115 mm.

Intermedio
Aluminio

19502-NS

19502-AS

19502-BS

Envase 1

Intermedio
Acero

19502-NSN

19502-ASN

19502-BSN

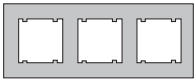

Marco 3 elementos horizontal
257x115 mm.

Intermedio
Aluminio

19503-NS

19503-AS

19503-BS

Envase 1

Intermedio
Acero

19503-NSN

19503-ASN

19503-BSN

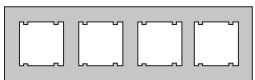

Marco 4 elementos horizontal
328x115 mm.

Intermedio
Aluminio

19504-NS

19504-AS

19504-BS

Envase 1

Intermedio
Acero

19504-NSN

19504-ASN

19504-BSN

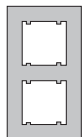

Marco 2 elementos vertical
115x186 mm.

Intermedio
Aluminio

19402-NS

19402-AS

19402-BS

Envase 1

Intermedio
Acero

19402-NSN

19402-ASN

19402-BSN

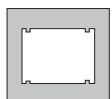

Marco para pantalla táctil
150x125 mm.

Intermedio
Aluminio

19507-NS

19507-AS

19507-BS

Envase 1

Intermedio
Acero

19507-NSN

19507-ASN

19507-BSN

Los marcos Magna se pueden pedir con piezas intermedias en Aluminio o Acero

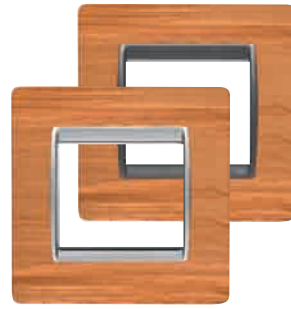

ARCE

CEREZO

ROBLE

WENGUÉ

19501-AR

19501-CZ

19501-RA

19501-WG

19501-ARN

19501-CZN

19501-RAN

19501-WGN

19502-AR

19502-CZ

19502-RA

19502-WG

19502-ARN

19502-CZN

19502-RAN

19502-WGN

19503-AR

19503-CZ

19503-RA

19503-WG

19503-ARN

19503-CZN

19503-RAN

19503-WGN

19504-AR

19504-CZ

19504-RA

19504-WG

19504-ARN

19504-CZN

19504-RAN

19504-WGN

19402-AR

19402-CZ

19402-RA

19402-WG

19402-ARN

19402-CZN

19402-RAN

19402-WGN

19507-AR

19507-CZ

19507-RA

19507-WG

19507-ARN

19507-CZN

19507-RAN

19507-WGN

**MECANISMOS RADIOFRECUENCIA
DISPOSITIVOS PARA EMPOTRAR**



RF265626
Emisor universal de 2 canales (230VAc)



RF265627
Emisor universal de 2 canales



RF265628
Emisor de temperatura



RF240696
Actuador para persianas



RF240694
Actuador de interrupción libre de tensión



RF240695
Actuador de interrupción bipolar



RF240702
Actuador "dimmer" enchufable



RF240699
Actuador de interrupción enchufable



RF265625
Actuador "dimmer"



RF265623
Actuador de interrupción



RF240697
Regulador analógico 0- 10Vdc



RF240698
Regulador analógico 1- 10Vdc

DISPOSITIVOS DE SUPERFICIE



RF265641
Pulsador simple



RF265642
Pulsador doble



RF290270
Bastidor para pulsador
Bjc Iris - Bjc Aura



RF290270-1
Bastidor para pulsador
Bjc Mega - Bjc Magna



RF265640
Termostato de ambiente

IRIS / AURA MATE / MAGNA

Tecla para Pulsador Simple de Radiofrecuencia.



BLANCO
RF18105



BEIGE
RF18105-A



N. ANTRACITA
RF18105-AT



DOR. ODISEA
RF18105-OD



ALUM. MERC.
RF18105-MA

Tecla para Pulsador Doble de Radiofrecuencia.



BLANCO
RF18205



BEIGE
RF18205-A



N. ANTRACITA
RF18205-AT



DOR. ODISEA
RF18205-OD



ALUM. MERC.
RF18205-MA

Tecla para Pulsador Simple de Radiofrecuencia.
(marcado ON/OFF)



BLANCO
RF18108



BEIGE
RF18108-A



N. ANTRACITA
RF18108-AT



DOR. ODISEA
RF18108-OD



ALUM. MERC.
RF18108-MA

Tecla para Pulsador Doble de Radiofrecuencia.
(marcado ON/OFF)



BLANCO
RF18208



BEIGE
RF18208-A



N. ANTRACITA
RF18208-AT



DOR. ODISEA
RF18208-OD



ALUM. MERC.
RF18208-MA

Tecla para Pulsador Simple de Radiofrecuencia.
(marcado para persiana o dimmer)



BLANCO
RF18165



BEIGE
RF18165-A



N. ANTRACITA
RF18165-AT



DOR. ODISEA
RF18165-OD



ALUM. MERC.
RF18165-MA

Tecla para Pulsador Doble de Radiofrecuencia.
(marcado para persiana o dimmer)



BLANCO
RF18265



BEIGE
RF18265-A



N. ANTRACITA
RF18265-AT



DOR. ODISEA
RF18265-OD



ALUM. MERC.
RF18265-MA

AURA BRILLO

NACAR



ACERO NEP.
RF18105-AN



R. RUBI
RF18105-RR



AZUL MING
RF18105-AM



V. MINERVA
RF18105-VM



COBRE JAIPUR
RF18105-CJ



DOR. ARENA
RF18105-DA



ACER. VOLCAN
RF18105-AV



R. PROTEO
RF18105-RP

Envase
1



NACAR BRILLANTE
RF18105-NB

Envase
1



ACERO NEP.
RF18205-AN



R. RUBI
RF18205-RR



AZUL MING
RF18205-AM



V. MINERVA
RF18205-VM



COBRE JAIPUR
RF18205-CJ



DOR. ARENA
RF18205-DA



ACER. VOLCAN
RF18205-AV



R. PROTEO
RF18205-RP

Envase
1

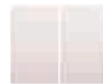

NACAR BRILLANTE
RF18205-NB

Envase
1



ACERO NEP.
RF18108-AN



R. RUBI
RF18108-RR



AZUL MING
RF18108-AM



V. MINERVA
RF18108-VM



COBRE JAIPUR
RF18108-CJ



DOR. ARENA
RF18108-DA



ACER. VOLCAN
RF18108-AV

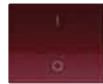

R. PROTEO
RF18108-RP

Envase
1



NACAR BRILLANTE
RF18108-NB

Envase
1



ACERO NEP.
RF18208-AN



R. RUBI
RF18208-RR



AZUL MING
RF18208-AM

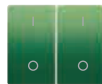

V. MINERVA
RF18208-VM



COBRE JAIPUR
RF18208-CJ



DOR. ARENA
RF18208-DA



ACER. VOLCAN
RF18208-AV



R. PROTEO
RF18208-RP

Envase
1



NACAR BRILLANTE
RF18208-NB

Envase
1



ACERO NEP.
RF18165-AN



R. RUBI
RF18165-RR



AZUL MING
RF18165-AM



V. MINERVA
RF18165-VM



COBRE JAIPUR
RF18165-CJ



DOR. ARENA
RF18165-DA



ACER. VOLCAN
RF18165-AV



R. PROTEO
RF18165-RP

Envase
1



NACAR BRILLANTE
RF18165-NB

Envase
1



ACERO NEP.
RF18265-AN



R. RUBI
RF18265-RR



AZUL MING
RF18265-AM



V. MINERVA
RF18265-VM



COBRE JAIPUR
RF18265-CJ



DOR. ARENA
RF18265-DA



ACER. VOLCAN
RF18265-AV



R. PROTEO
RF18265-RP

Envase
1









NACAR BRILLANTE
RF18265-NB

Envase
1

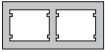

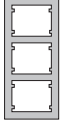
bjc Iris



	BLANCO	BEIGE	DORADO ODISEA	ALUMINIO MERCURIO	ACERO NEPTUNO	ROJO RUBI
 Marco 1 elemento horizontal/vertical Envase 10	18001	18001-A	18001-OD	18001-MA	18001-AN	18001-RR
 Marco 2 elementos horizontal Envase 10	18002	18002-A	18002-OD	18002-MA	18002-AN	18002-RR
 Marco 3 elementos horizontal Envase 5	18003	18003-A	18003-OD	18003-MA	18003-AN	18003-RR
 Marco 4 elementos horizontal Envase 5	18004	18004-A	18004-OD	18004-MA	18004-AN	18004-RR
 Marco 2 elementos vertical Envase 10	18102	18102-A	18102-OD	18102-MA	18102-AN	18102-RR
 Marco 3 elementos vertical Envase 5	18103	18103-A	18103-OD	18103-MA	18103-AN	18103-RR
 Marco 4 elementos vertical Envase 5	18104	18104-A	18104-OD	18104-MA	18104-AN	18104-RR
 Embellecedor exterior (2 unid) para marcos de posición horizontal (opcional) Envase 10	 ORO BRILLO 18600-OR	 ORO MATE 18600-ORM	 NIQUEL BRILLO 18600-NI	 NIQUEL MATE 18600-NIM		

bjc Aura



	BLANCO	BEIGE	DORADO ODISEA	ALUMINIO MERCURIO	ACERO NEPTUNO	
 Marco 1 elemento horizontal/vertical Envase 10	19001	19001-A	19001-OD	19001-MA	19001-AN	
 Marco 2 elementos horizontal/vertical Envase 10	19002	19002-A	19002-OD	19002-MA	19002-AN	
 Marco 3 elementos horizontal/vertical Envase 5	19003	19003-A	19003-OD	19003-MA	19003-AN	
 Marco 4 elementos horizontal/vertical Envase 5	19004	19004-A	19004-OD	19004-MA	19004-AN	
 Embellecedor intermedio (necesario) Envase 10	 BLANCO 19600	 BEIGE 19600-A	 DORADO ARENA 19600-DA	 ACERO VOLCAN 19600-AV	 ROJO PROTEO 19600-RP	 VAINILLA BRILLO 19600-VB



AZUL MING	VERDE MINERVA	COBRE JAIPUR	NACAR BRILLANTE	AMARILLO VAINILLA	AZUL LAVANDA	VERDE MENTA	HAYA	GRANITO
18001-AM	18001-VM	18001-CJ	18001-NB	18001-VA	18001-LA	18001-MV	18001-HY	18001-GT
18002-AM	18002-VM	18002-CJ	18002-NB	18002-VA	18002-LA	18002-MV	18002-HY	18002-GT
18003-AM	18003-VM	18003-CJ	18003-NB	18003-VA	18003-LA	18003-MV	18003-HY	18003-GT
18004-AM	18004-VM	18004-CJ	18004-NB	18004-VA	18004-LA	18004-MV	18004-HY	18004-GT
18102-AM	18102-VM	18102-CJ	18102-NB	18102-VA	18102-LA	18102-MV	18102-HY	18102-GT
18103-AM	18103-VM	18103-CJ	18103-NB	18103-VA	18103-LA	18103-MV	18103-HY	18103-GT
18104-AM	18104-VM	18104-CJ	18104-NB	18104-VA	18104-LA	18104-MV	18104-HY	18104-GT



DORADO ARENA	ACERO VOLCAN	ROJO PROTEO	NACAR BRILLANTE
19001-DA	19001-AV	19001-RP	19001-NB
19002-DA	19002-AV	19002-RP	19002-NB
19003-DA	19003-AV	19003-RP	19003-NB
19004-DA	19004-AV	19004-RP	19004-NB

Dimensiones de las placas (bjc Iris)

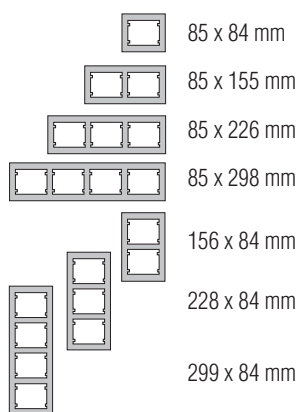

Dimensiones de las placas (bjc Aura)
Tanto en vertical como horizontal

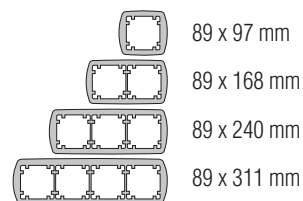

MENTA BRILLO	ORO BRILLO	ORO MATE	NIQUEL BRILLO	NIQUEL MATE
19600-MB	19600-OR	19600-ORM	19600-NI	19600-NIM



NEGRO BRILLO

AZUL BRILLO

BLANCO SATINADO



Marco 1 elemento horizontal/vertical
115x115 mm.

Envase 1

Intermedio
Aluminio

19501-NS

19501-AS

19501-BS

Intermedio
Acero

19501-NSN

19501-ASN

19501-BSN

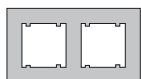

Marco 2 elementos horizontal
186x115 mm.

Envase 1

Intermedio
Aluminio

19502-NS

19502-AS

19502-BS

Intermedio
Acero

19502-NSN

19502-ASN

19502-BSN

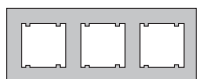

Marco 3 elementos horizontal
257x115 mm.

Envase 1

Intermedio
Aluminio

19503-NS

19503-AS

19503-BS

Intermedio
Acero

19503-NSN

19503-ASN

19503-BSN

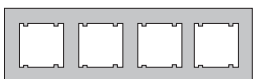

Marco 4 elementos horizontal
328x115 mm.

Envase 1

Intermedio
Aluminio

19504-NS

19504-AS

19504-BS

Intermedio
Acero

19504-NSN

19504-ASN

19504-BSN

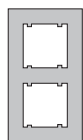

Marco 2 elementos vertical
115x186 mm.

Envase 1

Intermedio
Aluminio

19402-NS

19402-AS

19402-BS

Intermedio
Acero

19402-NSN

19402-ASN

19402-BSN

Los marcos Magna se pueden pedir con piezas intermedias en Aluminio o Acero



ARCE

CEREZO

ROBLE

WENGUÉ

19501-AR

19501-CZ

19501-RA

19501-WG

19501-ARN

19501-CZN

19501-RAN

19501-WGN

19502-AR

19502-CZ

19502-RA

19502-WG

19502-ARN

19502-CZN

19502-RAN

19502-WGN

19503-AR

19503-CZ

19503-RA

19503-WG

19503-ARN

19503-CZN

19503-RAN

19503-WGN

19504-AR

19504-CZ

19504-RA

19504-WG

19504-ARN

19504-CZN

19504-RAN

19504-WGN

19402-AR

19402-CZ

19402-RA

19402-WG

19402-ARN

19402-CZN

19402-RAN

19402-WGN