

# Amortiguadores

**INDA**matic  
cierres progresivos

# Amortiguadores

**INDA**matic  
cierres progresivos

	<i>págs.</i>
<b>1</b> AMORTIGUADORES INDEPENDIENTES .....	39
■ EMBUTIDOS .....	39
■ SOBREPUESTOS .....	39
<hr/>	
<b>2</b> AMORTIGUADORES PARA BISAGRAS "MESUCO" .....	39
■ PARA CAZOLETA .....	39



## 1 AMORTIGUADORES INDEPENDIENTES

### ■ EMBUTIDOS

#### AMORTIGUADOR INDAMATIC

			
BLANCO	RAL 9001	213.400.003	
NEGRO	RAL 9005	213.400.025	100
GRIS	RAL 7040	213.400.316	

**INDAmatic**  
cierre progresivo

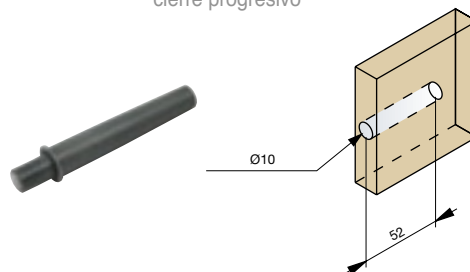

### ■ SOBREPUESTOS

#### BASE S/32 PARA AMORTIGUADOR

			
BLANCO	RAL 9001	213.500.000	
NEGRO	RAL 9005	213.500.022	100
GRIS	RAL 7040	213.500.313	

BASE REVERSIBLE: ÉSTA BASE ES VÁLIDA PARA POSICIONAR EL PRIMER TALADRO A 28 Ó 37 MM.

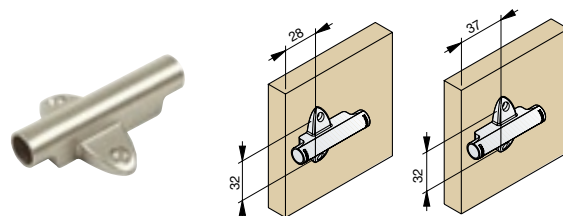

#### CUERPO Y BASE PARA AMORTIGUADOR

			
BLANCO	RAL 9001	213.600.004	
NEGRO	RAL 9005	213.600.026	100
GRIS	RAL 7040	213.600.310	

CADA REF. SE COMPONE DE 1 CUERPO Y 1 BASE.

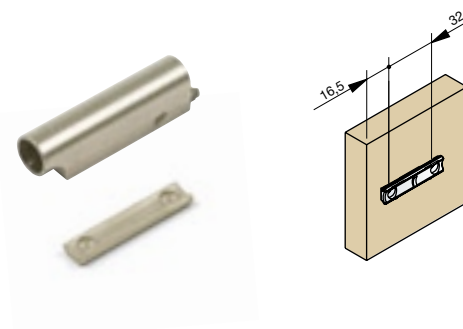

## 2 AMORTIGUADORES PARA BISAGRAS "MESUCO"

### ■ PARA CAZOLETA

#### INDAMATIC PARA CAZOLETA DE BISAGRA "MESUCO 143"

			
PLÁSTICO NIQUELADO		197.801.063	
ZAMAK NIQUELADO		197.802.065	125

**INDAmatic**  
cierre progresivo

