



PRESENTAMOS EL NUEVO CONCEPTO DE CAJÓN METÁLICO CON MÚLTIPLES POSIBILIDADES, RÁPIDO MONTAJE SIN HERRAMIENTAS Y MUY ECONÓMICO: EL “SUPRAPLEX”, EN UNA SOLA PIEZA PLEGABLE, Y EL “SUPRAKIT”, EN TRES PIEZAS MONTABLES MANUALMENTE.

“SUPRAPLEX”

“SUPRAKIT”

CAJONES



El cajón metálico a medida

LA GRAN VARIEDAD DE MEDIDAS EN EL DISEÑO ACTUAL NOS HA LLEVADO A DESARROLLAR ESTE CAJÓN DE GRAN VERSATILIDAD. ABARCA UNAS POSIBILIDADES INMENSAS TANTO EN PROFUNDIDAD, QUE VA DESDE 250 A 800 MM., COMO EN ANCHURA QUE, MILÍMETRO A MILÍMETRO, CUBRE DE 175 A 1.200 MM. EN EL "SUPRAKIT" QUE SE SUMINISTRA EN 3 PIEZAS, SE OFRECEN INCLUSO MEDIDAS INFERIORES A 175 MM. DE ANCHURA.



SUS TRES ALTURAS LE PERMITEN CUBRIR LAS DIVERSAS NECESIDADES QUE SE PRESENTAN EN LA INDUSTRIA DEL MUEBLE: EL CAJÓN BAJO DE 75 MM., EL MEDIANO DE 107 MM. Y EL ALTO DE 139 MM.



La solución ecológica

LOS CAJONES ESTÁN FABRICADOS EN ACERO RECICLABLE PRÁCTICAMENTE AL 100 %. ADEMÁS, SÓLO REQUIEREN UNA BASE DE 3 MM. DE ESPESOR, LO QUE REDUNDA EN EL AHORRO DE MADERA.





Buen apilamiento

EN EL ALMACENAMIENTO Y TRANSPORTE PRESENTA UN GRAN AHORRO YA QUE EL CAJÓN ES APILABLE Y OCUPA UN ESPACIO REDUCIDO.

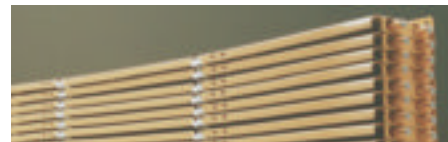
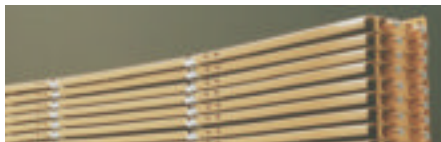
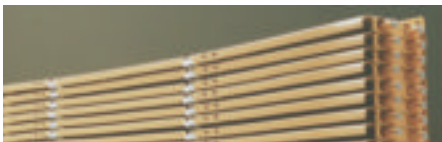



El color ideal

LA GRAN VARIEDAD DE DISEÑOS Y ACABADOS, HACEN QUE INDAUX PRESENTE ESTOS 5 COLORES PARA ATENDER LAS DIVERSAS TENDENCIAS DEL MUEBLE ACTUAL. PARA SERIES LARGAS PUEDE INCLUSO SUMINISTRARSE EN CUALQUIER OTRO COLOR.



BLANCO RAL 9001



NEGRO RAL 9005



GRIS PLATA RAL 9006



BLANCO RAL 9003

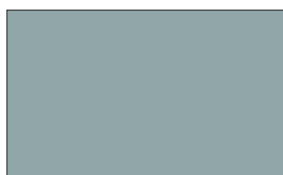

GRIS RAL 7040



ROBLE



Perfecta fijación

DOTADO DE UN SENCILLO MECANISMO QUE LE PERMITE FIJAR EL FRENTE AL COSTADO. IGUALMENTE, EN FUNCIÓN DE LA ANCHURA DEL CAJÓN, EL FABRICANTE DE MUEBLES PUEDE OPTAR POR COLOCAR UNOS SOPORTES DE APOYO QUE ASEGUREN LA BASE AL FRENTE. TODO ELLO SE REALIZA EN LA MISMA OPERACIÓN DE TALADRADO, EVITANDO LA CLÁSICA RANURA EN EL FRENTE.





Múltiples accesorios

LA VERSATILIDAD DE ESTE CAJÓN PERMITE SU COLOCACIÓN EN TODO TIPO DE MUEBLES. DESDE LA COCINA AL DESPACHO, PASANDO POR EL BAÑO O EL DORMITORIO, SIEMPRE ENCONTRARÁ LOS ACCESORIOS NECESARIOS PARA COMPLETAR SUS MUEBLES. BANDEJAS, PLUMIERES, ARCHIVADORES, CACEROLEROS, CUBERTEROS...



EL MONTAJE DEL CAJÓN
"SUPRAPLEX" Y "SUPRAKIT" ES MUY
SIMPLE Y NADA COSTOSO.

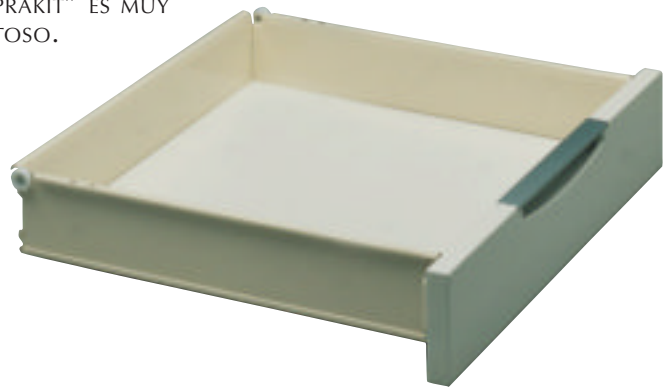

"Supraplex"

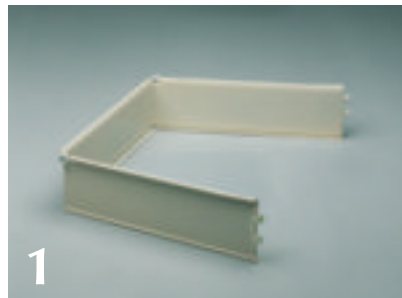

1
BASTA CON DOBLAR LA PIEZA METÁLICA HASTA
FORMAR UNA U.

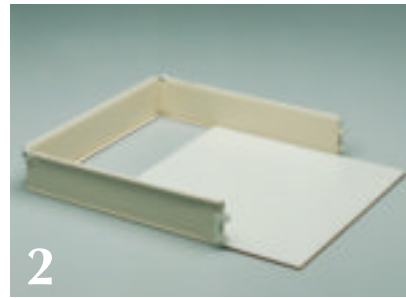

2
LA BASE SE INTRODUCE EN LA RANURA
EXISTENTE EN EL CAJÓN METÁLICO.

"SupraKit"



1
BASTA CON MONTAR MANUALMENTE LAS TRES
PIEZAS ENCAJÁNDOLAS EN LAS PESTAÑAS.

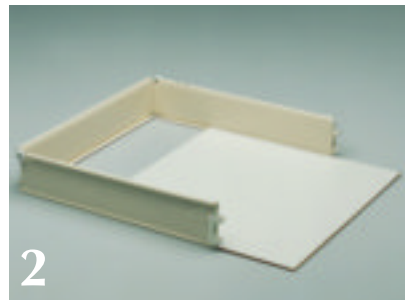

2
LA BASE SE INTRODUCE EN LA RANURA
EXISTENTE EN EL CAJÓN METÁLICO.

Sencillo montaje manual

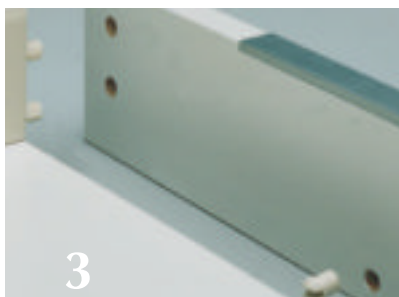

EL FRENTE SE INTRODUCE Y AJUSTA EN LOS PIVOTES DEL ENGANCHE PREMONTADO.

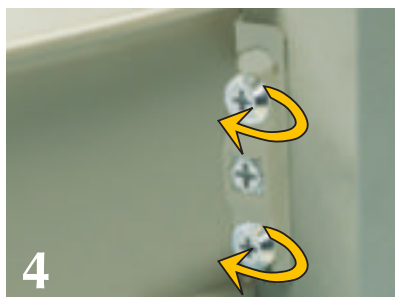

GIRANDO 180° QUEDARA EL CAJÓN MONTADO "SUPRAPLEX".



ESTE ENGANCHE FRONTAL PERMITE UNA REGULACIÓN VERTICAL DE +/- 2 MM.

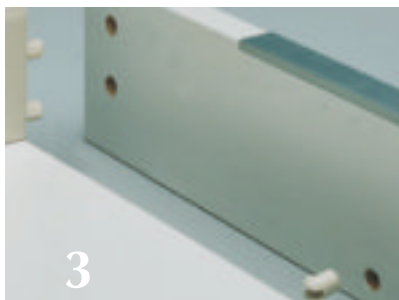

EL FRENTE SE INTRODUCE Y AJUSTA EN LOS PIVOTES DEL ENGANCHE PREMONTADO.

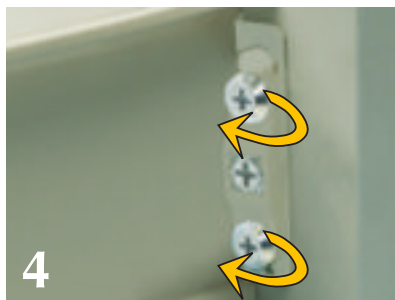

GIRANDO 180° QUEDARA EL CAJÓN MONTADO "SUPRAKIT".



ESTE ENGANCHE FRONTAL PERMITE UNA REGULACIÓN VERTICAL DE +/- 2 MM.

Cajones

"SUPRAPLEX - SUPRAKIT"

PRESENTAMOS EL NUEVO CONCEPTO DE CAJÓN METÁLICO CON MÚLTIPLES POSIBILIDADES, RÁPIDO MONTAJE SIN HERRAMIENTAS Y MUY ECONÓMICO: EL "SUPRAPLEX", EN UNA SOLA PIEZA PLEGABLE, Y EL "SUPRAKIT", EN TRES PIEZAS MONTABLES MANUALMENTE.

1	CAJÓN "SUPRAPLEX"	<i>págs.</i> 524
	■ CAJONES	524
	■ CORREDERAS	526
	■ "SUPRAPLEX" ESTÁNDARES COCINA	527
	■ "SUPRAPLEX" ESTÁNDARES OFICINA	528
	■ SOPORTE DE APOYO	529
<hr/>		
2	CAJÓN "SUPRAKIT" 530
	■ CAJONES	530
	■ CORREDERAS	532
	■ SOPORTE DE APOYO	533
	■ ADAPTADOR DE TRASERAS DE MADERA	533
<hr/>		
3	ACCESORIOS CAJÓN CACEROLERO 534
<hr/>		
4	ACCESORIOS DE OFICINA 535
	■ CAJÓN ARCHIVADOR	535
	■ CAJÓN PLUMIER	536
	■ BANDEJA INTERIOR	537
	■ DIVISOR	537
	■ CIERRE CENTRALIZADO	538
	■ DISPOSITIVO ANTIVUELCO	539
<hr/>		
5	DATOS TÉCNICOS 540

1 CAJÓN “SUPRAPLEX”

■ “SUPRAPLEX”: CAJONES

CAJONES REALIZADOS EN ACERO PINTADO Y QUE SE PLIEGAN MANUALMENTE. SE FABRICAN A LA MEDIDA SOLICITADA POR EL CLIENTE. SU MONTAJE NO NECESITA NINGÚN TIPO DE HERRAMIENTAS Y SON FÁCILMENTE APILABLES. ADEMÁS SON TOTALMENTE RECICLABLES.

CAJONES “SUPRAPLEX” DE 75, 107 Y 139 MM.

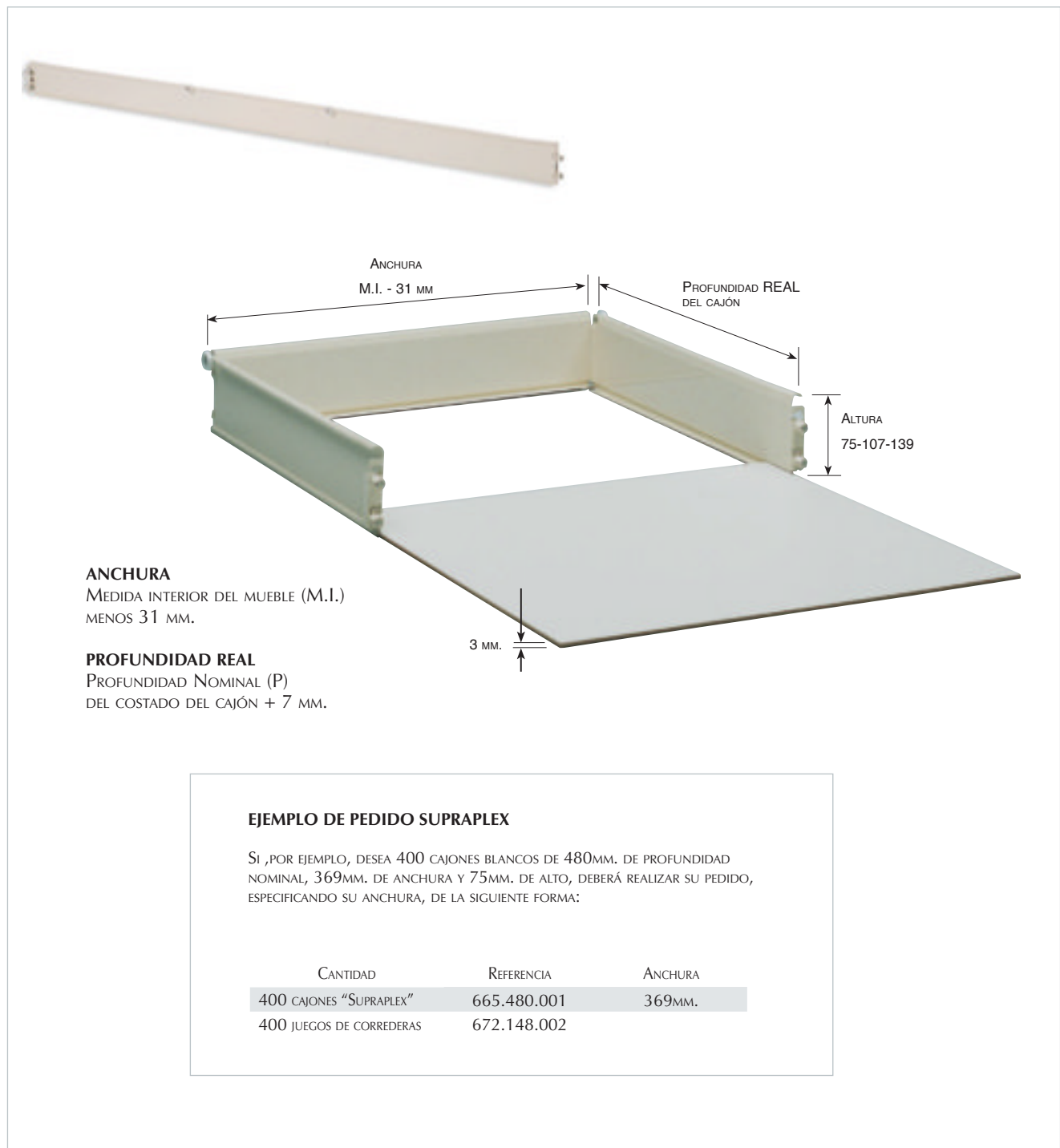

■ “SUPRAPLEX”: CAJONES

CAJONES “SUPRAPLEX 75”.

PROFUN. CAJÓN	BLANCO RAL 9001	BLANCO RAL 9003	NEGRO RAL 9005	GRIS RAL 7040	GRIS PLATA RAL 9006	ROBLE	
250	665.250.003	665.250.132	665.250.025	665.250.316	665.250.810	665.250.095	
270	665.270.001	665.270.130	665.270.023	665.270.314	665.270.815	665.270.093	
300	665.300.005	665.300.134	665.300.020	665.300.311	665.300.812	665.300.090	
350	665.350.000	665.350.136	665.350.022	665.350.313	665.350.814	665.350.092	
400	665.400.002	665.400.131	665.400.024	665.400.315	665.400.816	665.400.094	25
450	665.450.004	665.450.133	665.450.026	665.450.310	665.450.811	665.450.096	
480	665.480.001	665.480.130	665.480.023	665.480.314	665.480.815	665.480.093	
500	665.500.006	665.500.135	665.500.021	665.500.312	665.500.813	665.500.091	
550	665.550.001	665.550.130	665.550.023	665.550.314	665.550.815	665.550.093	



PEDIDO MÍNIMO DE 200 CAJONES POR REFERENCIA. INDIQUE LA ANCHURA DEL CAJÓN AL EFECTUAR SU PEDIDO.

CAJONES “SUPRAPLEX 107”.

PROFUN. CAJÓN	BLANCO RAL 9001	BLANCO RAL 9003	NEGRO RAL 9005	GRIS RAL 7040	GRIS PLATA RAL 9006	ROBLE	
250	666.250.001	666.250.130	666.250.023	666.250.314	666.250.815	666.250.093	
270	666.270.006	666.270.135	666.270.021	666.270.312	666.270.813	666.270.091	
300	666.300.003	666.300.132	666.300.025	666.300.316	666.300.810	666.300.095	
350	666.350.005	666.350.134	666.350.020	666.350.311	666.350.812	666.350.090	
400	666.400.000	666.400.136	666.400.022	666.400.313	666.400.814	666.400.092	25
450	666.450.002	666.450.131	666.450.024	666.450.315	666.450.816	666.450.094	
480	666.480.006	666.480.135	666.480.021	666.480.312	666.480.813	666.480.091	
500	666.500.004	666.500.133	666.500.026	666.500.310	666.500.811	666.500.096	
550	666.550.006	666.550.135	666.550.021	666.550.312	666.550.813	666.550.091	

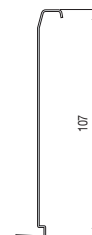

PEDIDO MÍNIMO DE 200 CAJONES POR REFERENCIA. INDIQUE LA ANCHURA DEL CAJÓN AL EFECTUAR SU PEDIDO.

CAJONES “SUPRAPLEX 139”.

PROFUN. CAJÓN	BLANCO RAL 9001	BLANCO RAL 9003	NEGRO RAL 9005	GRIS RAL 7040	GRIS PLATA RAL 9006	ROBLE	
250	667.250.006	667.250.135	667.250.021	667.250.312	667.250.813	667.250.091	
270	667.270.004	667.270.133	667.270.026	667.270.310	667.270.811	667.270.096	
300	667.300.001	667.300.130	667.300.023	667.300.314	667.300.815	667.300.093	
350	667.350.003	667.350.132	667.350.025	667.350.316	667.350.810	667.350.095	
400	667.400.005	667.400.134	667.400.020	667.400.311	667.400.812	667.400.090	25
450	667.450.000	667.450.136	667.450.022	667.450.313	667.450.814	667.450.092	
480	667.480.004	667.480.133	667.480.026	667.480.310	667.480.811	667.480.096	
500	667.500.002	667.500.131	667.500.024	667.500.315	667.500.816	667.500.094	
550	667.550.004	667.550.133	667.550.026	667.550.310	667.550.811	667.550.096	

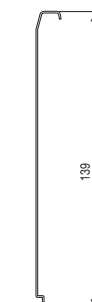

PEDIDO MÍNIMO DE 200 CAJONES POR REFERENCIA. INDIQUE LA ANCHURA DEL CAJÓN AL EFECTUAR SU PEDIDO.

NOTA

À LA HORA DE HACER UN PEDIDO, EL CLIENTE DEBE FACILITAR LAS MEDIDAS DE LA TRASERA Y DEL COSTADO DEL CAJÓN. PARA ELLO ES IMPORTANTE QUE SE TENGA EN CUENTA CÓMO ESTÁN CONTEMPLADAS ESTAS DOS DIMENSIONES.

■ “SUPRAPLEX”: CORREDERAS

CORREDERA “GACELA”

CARGA	PROFUNDIDAD NOMINAL DE CAJÓN	BLANCO RAL 9001	BLANCO RAL 9003	NEGRO RAL 9005	GRIS RAL 7040	GRIS PLATA RAL 9006	ROBLE	
200N (20 Kp.)	250	672.125.005	672.125.134	672.125.020	672.125.311	672.125.812	672.125.090	100
	270	672.127.002	672.127.131	672.127.024	672.127.315	672.127.816	672.127.094	
	300	672.130.001	672.130.130	672.130.023	672.130.314	672.130.815	672.130.093	
	350	672.135.004	672.135.133	672.135.026	672.135.310	672.135.812	672.135.096	
	400	672.140.000	672.140.136	672.140.022	672.140.313	672.140.814	672.140.092	
	450	672.145.003	672.145.132	672.145.025	672.145.316	672.145.810	672.145.095	
	480	672.148.002	672.148.131	672.148.024	672.148.315	672.148.816	672.148.094	
	500	672.150.006	672.150.135	672.150.021	672.150.312	672.150.813	672.150.091	
	550	672.155.002	672.155.131	672.155.024	672.155.315	672.155.816	672.155.094	

PEDIDO MÍNIMO DE 200 JUEGOS DE CORREDERAS POR REFERENCIA.
CON ESTAS REFERENCIAS SE EMPAQUETAN LOS PERFILES POR SEPARADO EN 2 CAJAS DE 100 PIEZAS.



CORREDERA “GACELA” TELESCÓPICA

CARGA	PROFUNDIDAD NOMINAL DE CAJÓN	BLANCO RAL 9001	BLANCO RAL 9003	NEGRO RAL 9005	GRIS RAL 7040	GRIS PLATA RAL 9006	ROBLE	
200N (20 Kp.)	250	653.725.004	653.725.133	653.725.026	653.725.310	653.725.811	653.725.096	100
	270	653.727.001	653.727.130	653.727.023	653.727.314	653.727.815	653.727.093	
	300	653.730.000	653.730.136	653.730.022	653.730.313	653.730.814	653.730.092	
	350	653.735.003	653.735.132	653.735.025	653.735.316	653.735.810	653.735.095	
	400	653.740.006	653.740.135	653.740.021	653.740.312	653.740.813	653.740.091	
	450	653.745.002	653.745.131	653.745.024	653.745.315	653.745.816	653.745.094	
	480	653.748.001	653.748.130	653.748.023	653.748.314	653.748.815	653.748.093	
	500	653.750.005	653.750.134	653.750.020	653.750.311	653.750.812	653.750.090	
	550	653.755.001	653.755.130	653.755.023	653.755.314	653.755.815	653.755.093	

PEDIDO MÍNIMO DE 200 JUEGOS DE CORREDERAS POR REFERENCIA.
CADA REFERENCIA SE COMPONE DE 2 PERFILES U Y 2 PERFILES S EMPAQUETADOS POR SEPARADO. LAS US EN CAJAS DE 100 UNIDADES Y LAS Ss EN CAJAS DE 50.



CORREDERAS PARA CAJONES “SUPRAPLEX”
DE 75, 107 Y 139 MM.

■ “SUPRAPLEX”: CAJONES Y CORREDERAS ESTÁNDARES DE COCINA

CAJÓN “SUPRAPLEX” COCINA (PROFUNDIDAD 487 MM.) BLANCO RAL 9001.

MÓDULO (COSTADO 16 MM.)	“SUPRAPLEX 75”	“SUPRAPLEX 107”	
300	672.730.004	672.830.001	25
350	672.735.000	672.835.004	
400	672.740.003	672.840.000	
450	672.745.006	672.845.003	
500	672.750.002	672.850.006	
600	672.760.001	672.860.005	

PEDIDO MÍNIMO DE 200 CAJONES POR REFERENCIA.

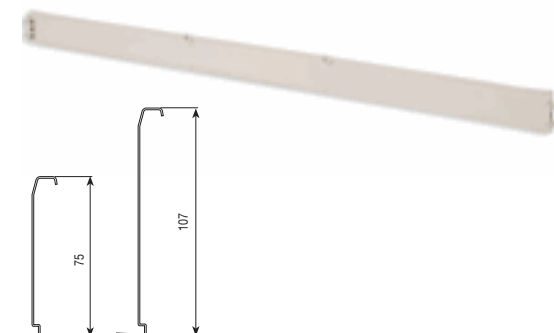

CORREDERAS GACELA, PROFUNDIDAD DEL CAJÓN 487 MM.

	BLANCO RAL 9001	
SENCILLA	672.148.002	100
TELESCÓPICA	653.748.000	

PEDIDO MÍNIMO DE 200 JUEGOS DE CORREDERAS POR REFERENCIA.



CUBERTERO (PROFUNDIDAD 487 MM.).

MÓDULO (COSTADO 16 MM.)	BLANCO RAL 9001	
300	687.430.004	20
350	687.435.000	
400	687.440.003	
450	687.445.006	
500	687.450.002	
600	687.460.001	

PEDIDO MÍNIMO DE 200 JUEGOS DE CORREDERAS POR REFERENCIA.



MÓDULO

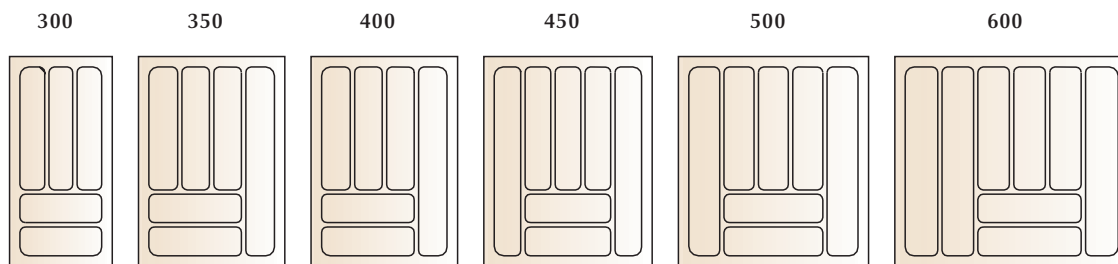

■ “SUPRAPLEX”: CAJONES Y CORREDERAS ESTÁNDARES DE OFICINA

CAJÓN “SUPRAPLEX” OFICINA (PROFUNDIDAD 507MM.).

MODULACIÓN INTERIOR 392	GRIS RAL 7040	NEGRO RAL 9005	
“SUPRAPLEX 75”	672.439.316	672.439.025	
“SUPRAPLEX 107”	672.539.313	672.539.022	25
“SUPRAPLEX 139”	672.639.310	672.639.026	

MODULACIÓN INTERIOR 425

	GRIS RAL 7040	NEGRO RAL 9005	
“SUPRAPLEX 75”	672.442.315	672.442.024	
“SUPRAPLEX 107”	672.542.312	672.542.021	25
“SUPRAPLEX 139”	672.642.316	672.642.025	

PEDIDO MÍNIMO DE 200 CAJONES POR REFERENCIA.



CORREDERAS GACELA, PROFUNDIDAD DEL CAJÓN 507MM.

	GRIS RAL 7040	NEGRO RAL 9005	
NORMAL	672.150.312	672.150.021	
TELÉSCOPICA	672.750.311	672.750.020	100

PEDIDO MÍNIMO DE 200 CORREDERAS POR REFERENCIA. CON ESTAS REFERENCIAS SE EMPAQUETAN LOS PERFILES POR SEPARADO EN 2 CAJAS DE 100 PIEZAS.



■ “SUPRAPLEX”: SOPORTE DE APOYO

SOPORTE DE APOYO.

DIAMETRO DEL TALADRO 10 MM.		
BLANCO RAL 9001	748.400.004	1000
BLANCO RAL 9003	748.400.133	
NEGRO RAL 9005	748.400.026	
GRIS RAL 7040	748.400.310	
GRIS PLATA 9006	748.400.811	
ROBLE	748.400.096	



PARA ANCHURAS SUPERIORES A 500 MM. ES ACONSEJABLE COLOCAR MÁS DE UN SOPORTE DE APOYO.

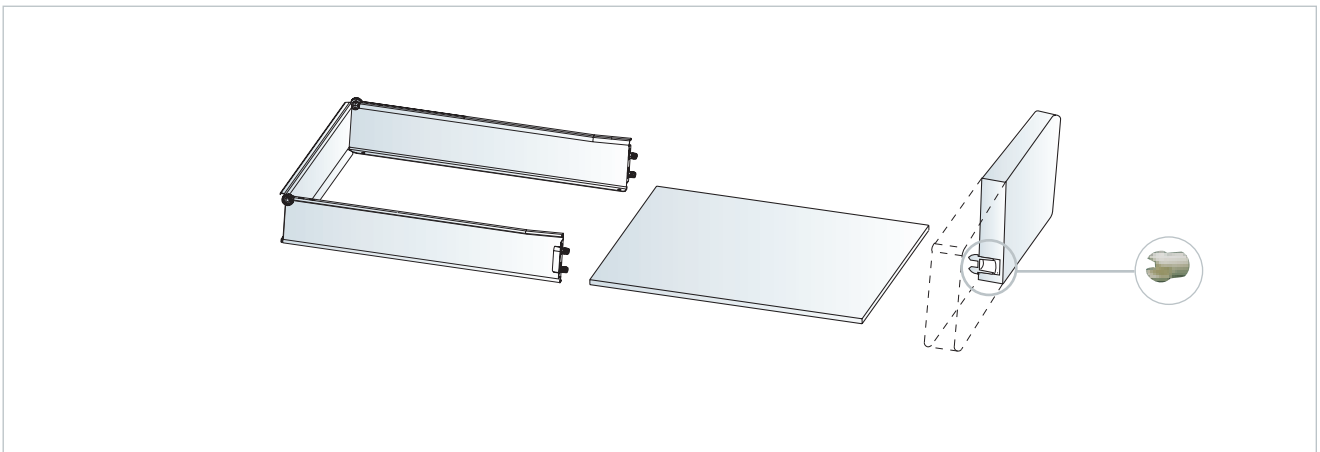

2 CAJÓN “SUPRAKIT”

■ “SUPRAKIT”: CAJONES

CAJONES REALIZADOS EN ACERO PINTADO EN TRES PIEZAS. SE FABRICAN A LA MEDIDA SOLICITADA POR EL CLIENTE. SU MONTAJE NO NECESITA NINGÚN TIPO DE HERRAMIENTAS Y SON FÁCILMENTE APILABLES. ADEMÁS SON TOTALMENTE RECICLABLES.

CAJONES “SUPRAKIT” DE 75, 107 Y 139 MM.

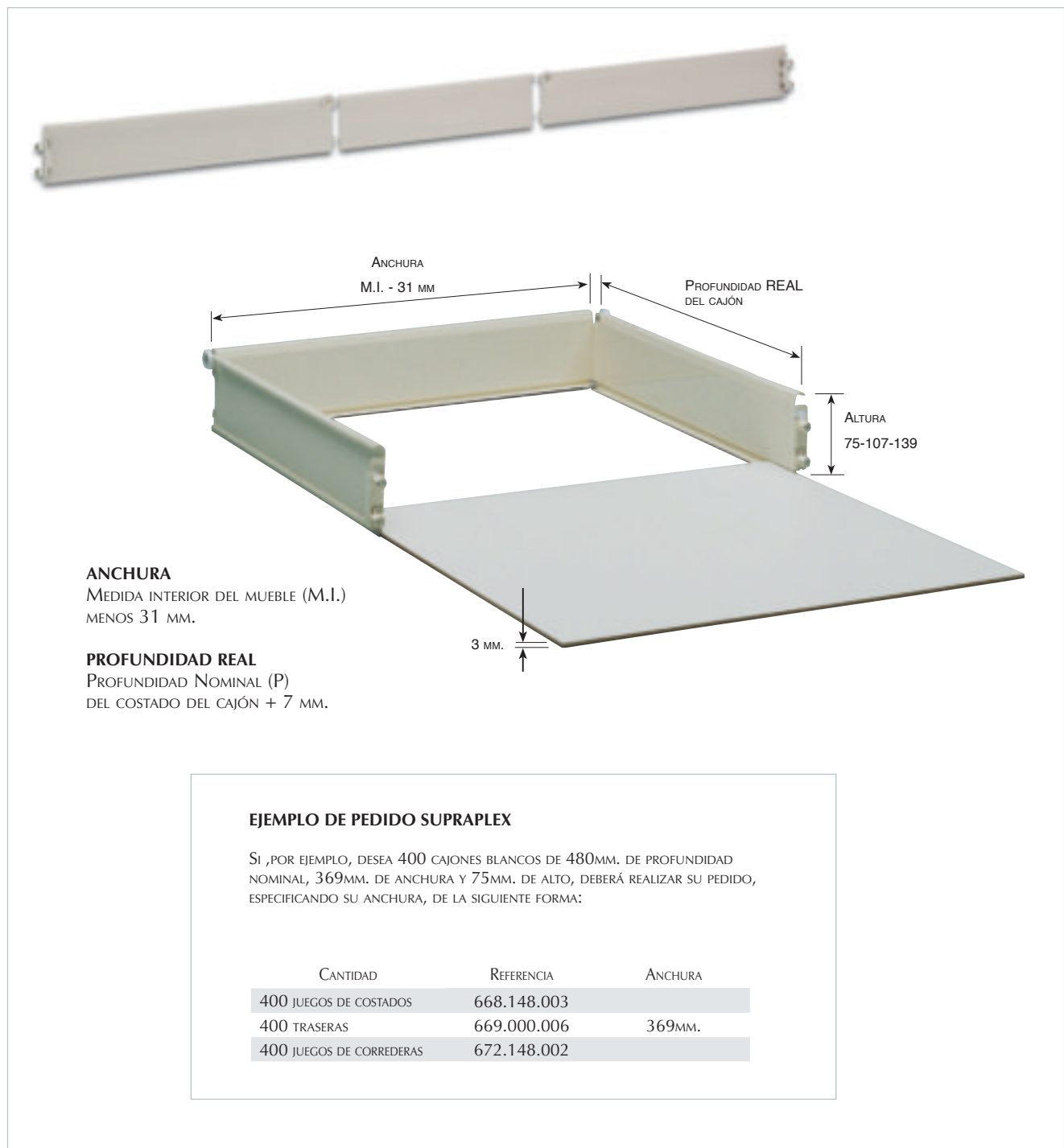

■ “SUPRAKIT”: CAJONES

CAJONES “SUPRAKIT 75”.

PROFUN. CAJÓN	BLANCO RAL 9001	BLANCO RAL 9003	NEGRO RAL 9005	GRIS RAL 7040	GRIS PLATA RAL 9006	ROBLE	
250	668.125.006	668.125.135	668.125.021	668.125.312	668.125.813	668.125.091	
270	668.127.003	668.127.132	668.127.025	668.127.316	668.127.810	668.127.095	
300	668.130.002	668.130.131	668.130.024	668.130.315	668.130.816	668.130.094	
350	668.135.005	668.135.134	668.135.020	668.135.311	668.135.812	668.135.090	
400	668.140.001	668.140.130	668.140.023	668.140.314	668.140.815	668.140.093	25
450	668.145.004	668.145.133	668.145.026	668.145.310	668.145.811	668.145.096	
480	668.148.003	668.148.132	668.148.025	668.148.316	668.148.810	668.148.095	
500	668.150.000	668.150.136	668.150.022	668.150.313	668.150.814	668.150.092	
550	668.155.003	668.155.132	668.155.025	668.155.316	668.155.810	668.155.095	
TRASERA	669.000.006	669.000.135	669.000.021	669.000.312	669.000.813	669.000.091	40



PEDIDO MÍNIMO DE 400 JUEGOS DE COSTADOS (COSTADO IZQD. + COSTADO DCHO.) Y 200 TRASERAS POR REFERENCIA. INDIQUE LA ANCHURA DE LA TRASERA AL EFECTUAR SU PEDIDO.

CAJONES “SUPRAKIT 107”.

PROFUN. CAJÓN	BLANCO RAL 9001	BLANCO RAL 9003	NEGRO RAL 9005	GRIS RAL 7040	GRIS PLATA RAL 9006	ROBLE	
250	668.225.003	668.225.132	668.225.025	668.225.316	668.225.810	668.225.095	
270	668.227.000	668.227.136	668.227.022	668.227.313	668.227.814	668.227.092	
300	668.230.006	668.230.135	668.230.021	668.230.312	668.230.813	668.230.091	
350	668.235.002	668.235.131	668.235.024	668.235.315	668.235.816	668.235.094	
400	668.240.005	668.240.134	668.240.020	668.240.311	668.240.812	668.240.090	25
450	668.245.001	668.245.130	668.245.023	668.245.314	668.245.815	668.245.093	
480	668.248.000	668.248.136	668.248.022	668.248.313	668.248.814	668.248.092	
500	668.250.004	668.250.133	668.250.026	668.250.310	668.250.811	668.250.096	
550	668.255.000	668.255.136	668.255.022	668.255.313	668.255.814	668.255.092	
TRASERA	670.000.004	670.000.133	670.000.026	670.000.310	670.000.811	670.000.096	40

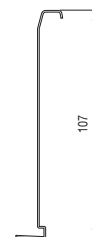

PEDIDO MÍNIMO DE 400 JUEGOS DE COSTADOS (COSTADO IZQD. + COSTADO DCHO.) Y 200 TRASERAS POR REFERENCIA. INDIQUE LA ANCHURA DE LA TRASERA AL EFECTUAR SU PEDIDO.

CAJONES “SUPRAKIT 139”.

PROFUN. CAJÓN	BLANCO RAL 9001	BLANCO RAL 9003	NEGRO RAL 9005	GRIS RAL 7040	GRIS PLATA RAL 9006	ROBLE	
250	668.325.000	668.325.136	668.325.022	668.325.313	668.325.814	668.325.092	
270	668.327.004	668.327.133	668.327.026	668.327.310	668.327.811	668.327.096	
300	668.330.003	668.330.132	668.330.025	668.330.316	668.330.810	668.330.095	
350	668.335.006	668.335.135	668.335.021	668.335.312	668.335.813	668.335.091	
400	668.340.002	668.340.131	668.340.024	668.340.315	668.340.816	668.340.094	25
450	668.345.005	668.345.134	668.345.020	668.345.311	668.345.812	668.345.090	
480	668.348.004	668.348.133	668.348.026	668.348.310	668.348.811	668.348.096	
500	668.350.001	668.350.130	668.350.023	668.350.314	668.350.815	668.350.093	
550	668.355.004	668.355.133	668.355.026	668.355.310	668.355.811	668.355.096	
TRASERA	671.000.002	671.000.131	671.000.024	671.000.315	671.000.816	671.000.094	40

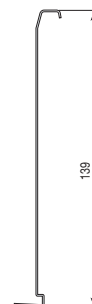

PEDIDO MÍNIMO DE 400 JUEGOS DE COSTADOS (COSTADO IZQD. + COSTADO DCHO.) Y 200 TRASERAS POR REFERENCIA. INDIQUE LA ANCHURA DE LA TRASERA AL EFECTUAR SU PEDIDO.

NOTA

À LA HORA DE HACER UN PEDIDO, EL CLIENTE DEBE FACILITAR LAS MEDIDAS DE LA TRASERA Y DEL COSTADO DEL CAJÓN. PARA ELLO ES IMPORTANTE QUE SE TENGA EN CUENTA CÓMO ESTÁN CONTEMPLADAS ESTAS DOS DIMENSIONES.

■ “SUPRAKIT”: CORREDERAS

CORREDERA “GACELA”.

CARGA	PROFUNDIDAD NOMINAL DE CAJÓN	BLANCO RAL 9001	BLANCO RAL 9003	NEGRO RAL 9005	GRIS RAL 7040	GRIS PLATA RAL 9006	ROBLE	
200N (20 Kp.)	250	672.125.005	672.125.134	672.125.020	672.125.311	672.125.812	672.125.090	100
	270	672.127.002	672.127.131	672.127.024	672.127.315	672.127.816	672.127.094	
	300	672.130.001	672.130.130	672.130.023	672.130.314	672.130.815	672.130.093	
	350	672.135.004	672.135.133	672.135.026	672.135.310	672.135.812	672.135.096	
	400	672.140.000	672.140.136	672.140.022	672.140.313	672.140.814	672.140.092	
	450	672.145.003	672.145.132	672.145.025	672.145.316	672.145.810	672.145.095	
	480	672.148.002	672.148.131	672.148.024	672.148.315	672.148.816	672.148.094	
	500	672.150.006	672.150.135	672.150.021	672.150.312	672.150.813	672.150.091	
	550	672.155.002	672.155.131	672.155.024	672.155.315	672.155.816	672.155.094	

PEDIDO MÍNIMO DE 200 JUEGOS DE CORREDERAS POR REFERENCIA.



CORREDERA “GACELA” TELESCÓPICA.

CARGA	PROFUNDIDAD NOMINAL DE CAJÓN	BLANCO RAL 9001	BLANCO RAL 9003	NEGRO RAL 9005	GRIS RAL 7040	GRIS PLATA RAL 9006	ROBLE	
200N (20 Kp.)	250	653.725.004	653.725.133	653.725.026	653.725.310	653.725.811	653.725.096	100
	270	653.727.001	653.727.130	653.727.023	653.727.314	653.727.815	653.727.093	
	300	653.730.000	653.730.136	653.730.022	653.730.313	653.730.814	653.730.092	
	350	653.735.003	653.735.132	653.735.025	653.735.316	653.735.810	653.735.095	
	400	653.740.006	653.740.135	653.740.021	653.740.312	653.740.813	653.740.091	
	450	653.745.002	653.745.131	653.745.024	653.745.315	653.745.816	653.745.094	
	480	653.748.001	653.748.130	653.748.023	653.748.314	653.748.815	653.748.093	
	500	653.750.005	653.750.134	653.750.020	653.750.311	653.750.812	653.750.090	
	550	653.755.001	653.755.130	653.755.023	653.755.314	653.755.815	653.755.093	

PEDIDO MÍNIMO DE 200 JUEGOS DE CORREDERAS POR REFERENCIA.

CADA REFERENCIA SE COMPONE DE 2 PERFILES U Y 2 PERFILES S EMPAQUETADOS POR SEPARADO.



CORREDERAS PARA CAJONES “SUPRAKIT”
DE 75, 107 Y 139 MM.

■ “SUPRAKIT”: SOPORTE DE APOYO

SOPORTE DE APOYO.

DIAMETRO DEL TALADRO 10 MM.		
BLANCO RAL 9001	748.400.004	
BLANCO RAL 9003	748.400.133	
NEGRO RAL 9005	748.400.026	1000
GRIS RAL 7040	748.400.310	
GRIS PLATA 9006	748.400.811	
ROBLE	748.400.096	



PARA ANCHURAS SUPERIORES A 500 MM. ES ACONSEJABLE COLOCAR MÁS DE UN SOPORTE DE APOYO.

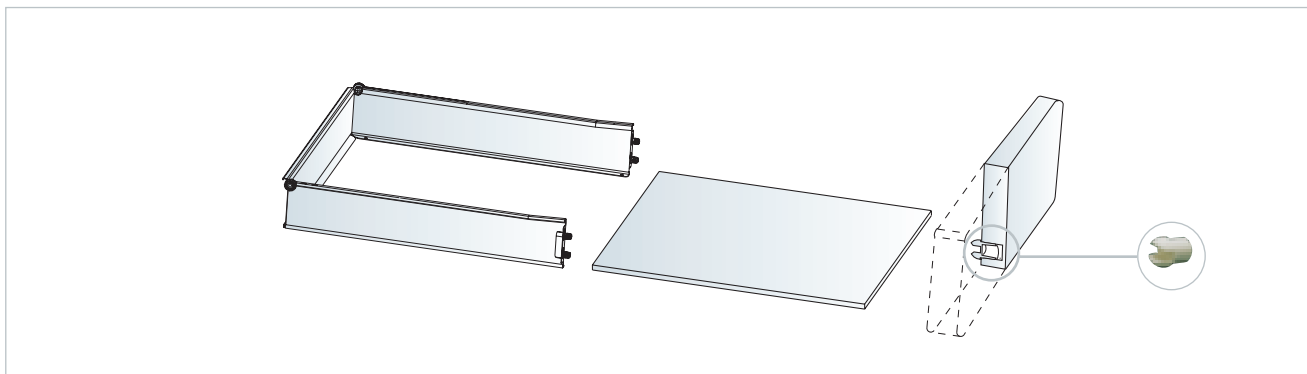

■ “SUPRAKIT”: ADAPTADOR DE TRASERAS DE MADERA

ADAPTADOR DE TRASERAS DE MADERA PARA CAJÓN “SUPRAKIT”.

ZINCADO		
SUPRAKIT 75	736.075.034	
SUPRAKIT 107	736.107.035	200
SUPRAKIT 139	736.139.036	

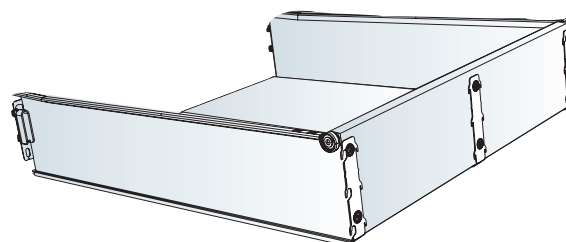

ESTE ADAPTADOR LE PERMITE SOLVENTAR CUALQUIER EMERGENCIA PARA CONSEGUIR CUALQUIER MODULACIÓN DE CAJÓN.

NOTA: PARA MÓDULOS SUPERIORES A 500 MM. SE RECOMIENDA COLOCAR 3 O MÁS ADAPTADORES.

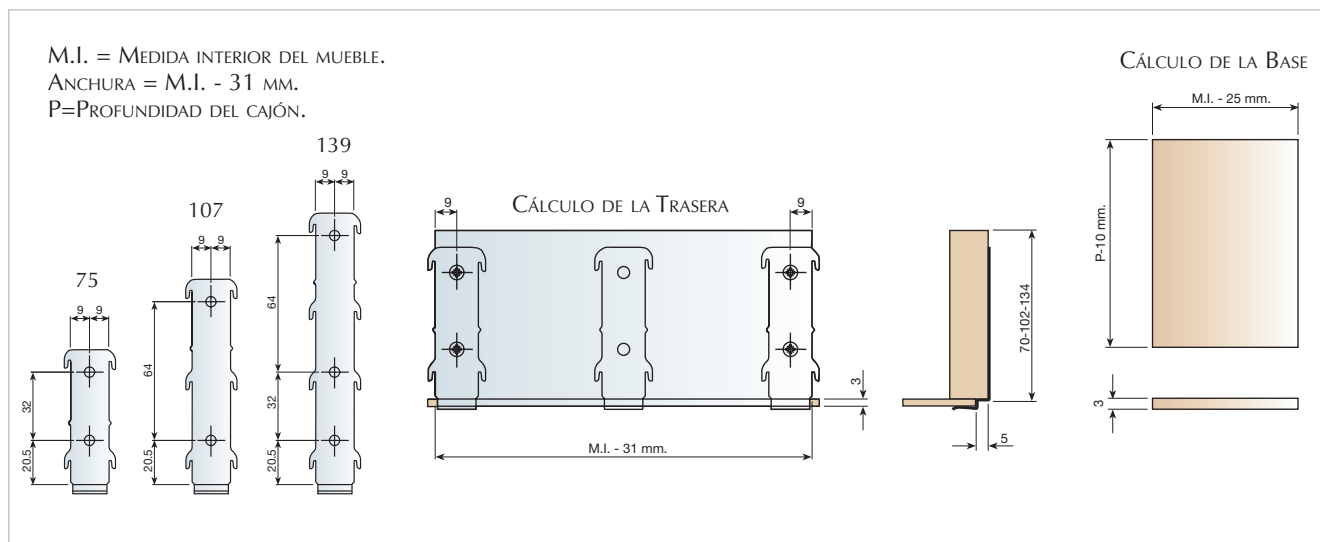

3 ACCESORIOS CAJÓN CACEROLERO

ACCESORIOS CACEROLERO.

	BLANCO RAL 9001	
JUEGO PARA CAJÓN COMPLETO	733.500.003	50

CADA REFERENCIA COMPRENDE UN JUEGO COMPLETO DE ACCESORIOS CON LOS SIGUIENTES ELEMENTOS: 2 ENGANCHES FRONTALES DE Ø10, 2 TUBOS LATERALES, 1 SOPORTE TRASERO IZQUIERDO Y 1 SOPORTE TRASERO DERECHO. LOS TUBOS SEPARADORES SE PIDEN INDEPENDIEMENTE PARA QUE PUEDA UTILIZAR LAS SEPARACIONES QUE DESEE EN CADA CAJÓN.

NOTA ESTE CONJUNTO DE ACCESORIOS SIRVE PARA ADAPTARSE A LAS 3 ALTURAS DE “SUPRAPLEX” Y “SUPRAKIT”.

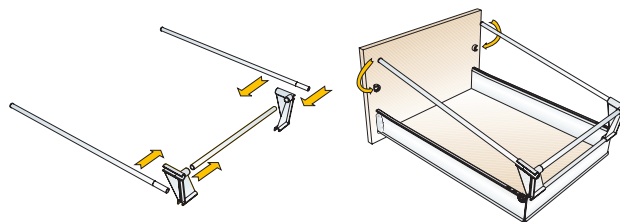
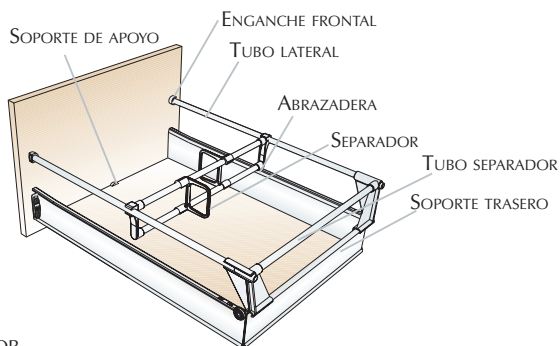

TUBO SEPARADOR.

MÓDULO (COSTADO 16 MM.)	BLANCO RAL 9001	
300	746.830.000	
350	746.835.003	
400	746.840.006	50
450	746.845.002	
500	746.850.005	
600	746.860.004	
LONGITUD 1000 MM.	746.800.003	50

ABRAZADERA.

	BLANCO RAL 9001	
	732.400.001	100

SEPARADOR.

	BLANCO RAL 9001	
	748.100.006	50

DIMENSIONES (MM.)	D	A	T
“SUPRAPLEX 75”	96	14	154
“SUPRAPLEX 107”	96	46	186
“SUPRAPLEX 139”	128	46	218

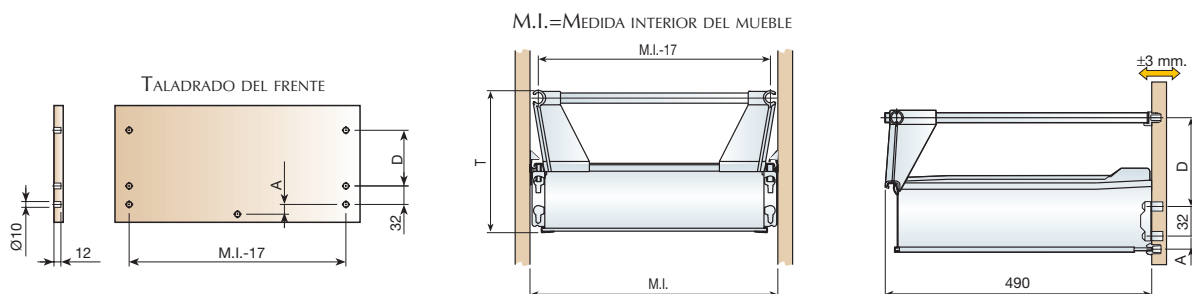

4 ACCESORIOS DE OFICINA

CAJÓN ARCHIVADOR

JUEGO DE ACCESORIOS PARA ARCHIVADOR.

	ZINCADO	NEGRO RAL 9005	
	733.607.033	733.607.022	50

CADA REFERENCIA COMPRENDE UN JUEGO COMPLETO DE ACCESORIOS CON LOS SIGUIENTES ELEMENTOS: 2 ENGANCHE FRONTALES DE Ø10, 2 VARILLAS LATERALES, 1 SOPORTE TRASERO IZQUIERDO Y 1 SOPORTE TRASERO DERECHO. LOS ACCESORIOS PLÁSTICOS SON EN NEGRO.

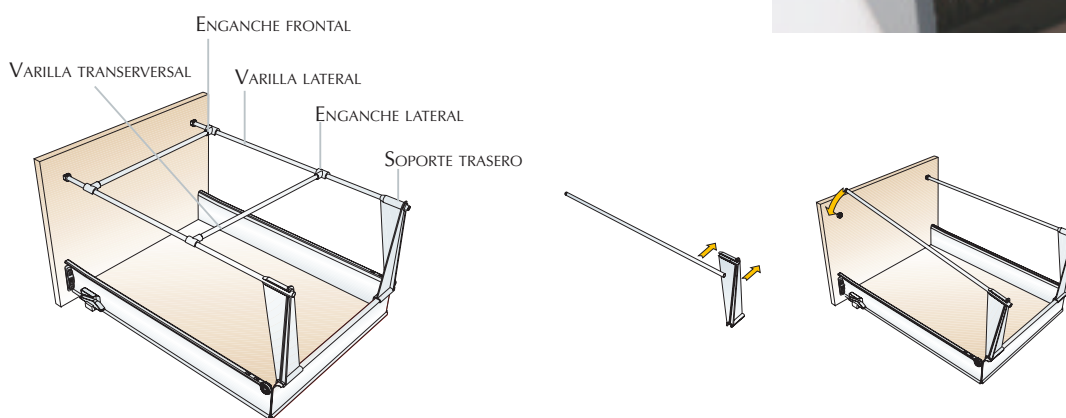

JUEGO DE VARILLA TRANSVERSAL PARA ARCHIVADOR.

	ZINCADO	NEGRO RAL 9005	
	733.807.034	733.807.023	50

1 VARILLA TRANSVERSAL Y 2 ENGANCHE LATERALES NEGROS POR REFERENCIA.

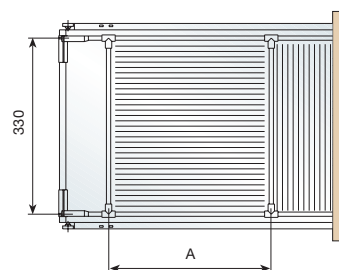

A (MM.)	M.I.= 392 MM.	M.I.= 425 MM.
DIN A4/CARTA	330	330
FOLIO	-	366
LEGAL/OFICIO	-	386

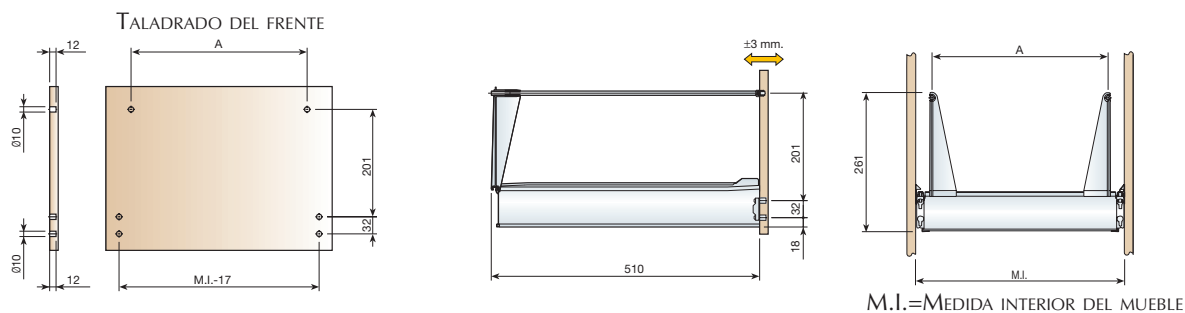

■ CAJÓN PLUMIER



CAJÓN PLUMIER.

PROFUNDIDAD DEL CAJÓN	GRIS RAL 7040	NEGRO RAL 9005	
500	662.800.316	662.800.025	25

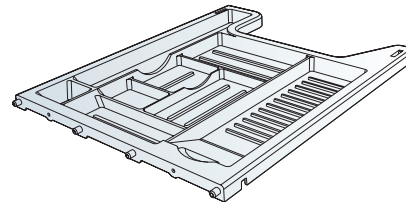

CORREDERAS PARA PLUMIER.

MODULACIÓN INTERIOR	ZINCADO	
392	779.392.751	25
425	779.425.754	

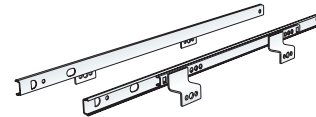

CON ESTAS REFERENCIAS SE EMPAQUETAN LAS CORREDERAS POR SEPARADO EN DOS CAJAS DE 25 PIEZAS.

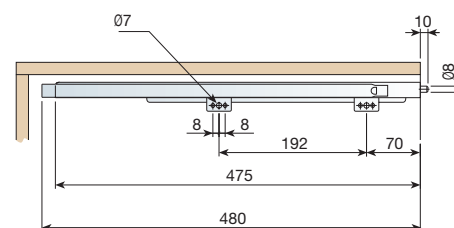
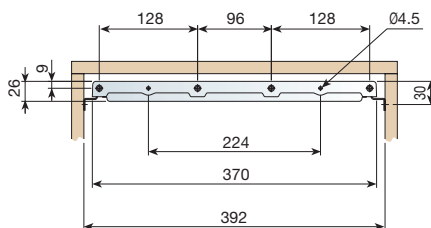

BANDEJA INTERIOR



BANDEJA INTERIOR EXTENSIBLE.

	GRIS RAL 7040	NEGRO RAL 9005	
1 UD.	735.900.314	735.900.023	25

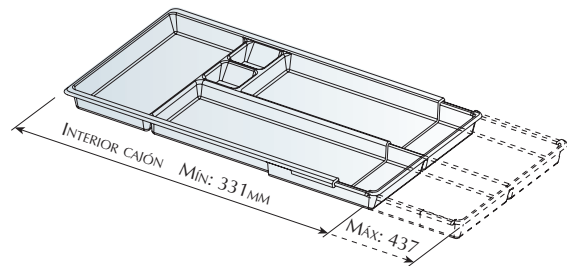

BANDEJA INTERIOR.

MODULACIÓN INTERIOR	GRIS RAL 7040	NEGRO RAL 9005	
380	735.380.310	735.380.026	25
392	735.392.313	735.392.022	
425	735.425.316	735.425.025	

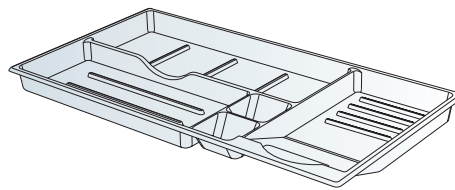

DIVISOR



DIVISOR.

MODULACIÓN INTERIOR	GRIS RAL 7040	NEGRO RAL 9005	
392	734.239.310	734.239.026	25

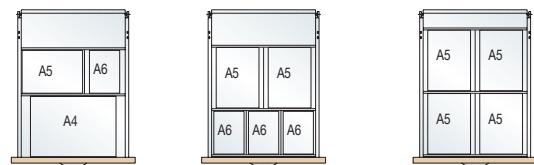

DIVISOR LONGITUDINAL.

L=LONGITUD	GRIS RAL 7040	NEGRO RAL 9005	
160	734.516.311	734.516.020	125
220	734.522.316	734.522.025	

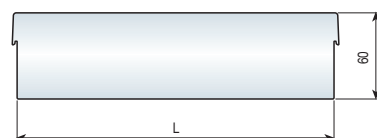

CIERRE CENTRALIZADO

CIERRE CENTRALIZADO.

	NIQUELADO	
	662.600.061	50

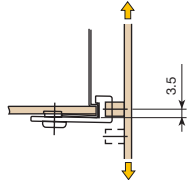
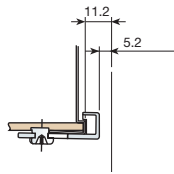

$$D = c + r + 1 > 40$$

c = DISTANCIA DEL FRENTE AL CENTRO DE LA PLETINA DE LA CERRADURA.

r = RADIO DEL PIVOTE DE CERRADURA.

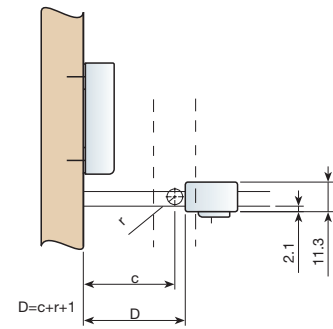
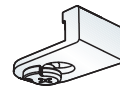

PARA GRANDES SERIES SE OFRECEN COSTADOS DE CAJÓN PRETALADRADOS EN LA POSICIÓN DESEADA PARA COLOCAR A PRESIÓN EL CIERRE CENTRALIZADO O EL DISPOSITIVO ANTIVUELCO.

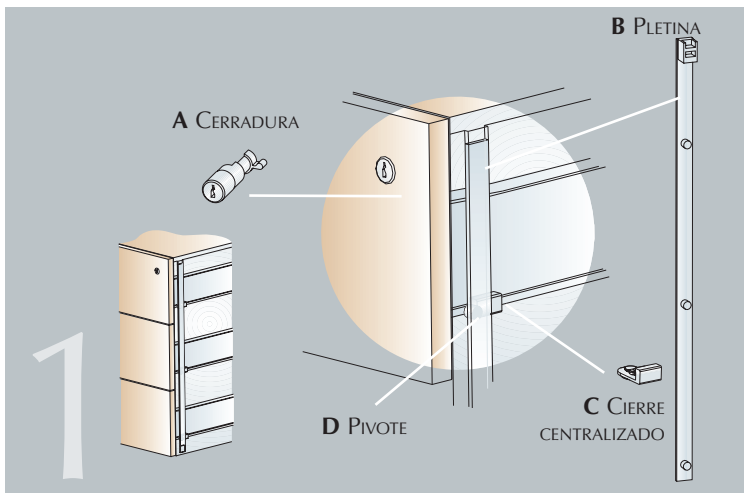

CAJONERA CERRADA, LOS PIVOTES **D** DE LA PLETINA **B** IMPIDEN LA APERTURA DE LOS CAJONES CON EL CIERRE CENTRALIZADO **C**.

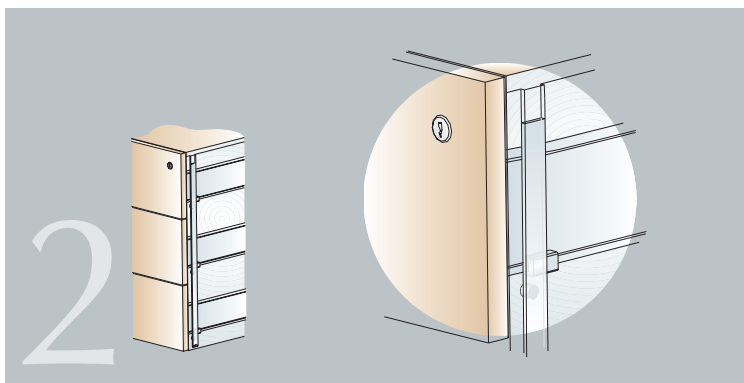

CAJONERA ABIERTA, AL GIRAR LA CERRADURA **A**, LA PLETINA **B** SE DESPLAZA HACIA ABAJO. LOS CAJONES PUEDEN ABRIRSE SIN TROPEZAR CON LOS PIVOTES **D**.

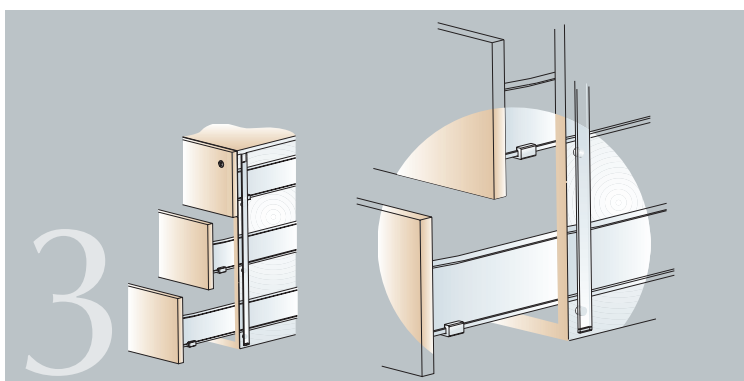

AL ABRIR UN CAJÓN NO SE ACTÚA SOBRE LA PLETINA **B**, POR LO QUE SE PUEDEN ABRIR SIMULTÁNEAMENTE TODOS LOS CAJONES DE LA CAJONERA.

DISPOSITIVO ANTIVUELCO

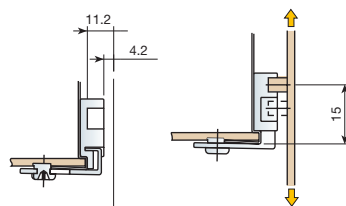

DISPOSITIVO ANTIVUELCO.

NEGRO RAL 9005



662.700.021 50

EL DISPOSITIVO ANTIVUELCO ES COMPLEMENTARIO AL CIERRE CENTRALIZADO Y NO PUEDE SER INSTALADO SIN ÉL. EL ANTIVUELCO SE MONTA EN EL CIERRE CENTRALIZADO ANTES DE SER INSTALADO EN EL CAJÓN.

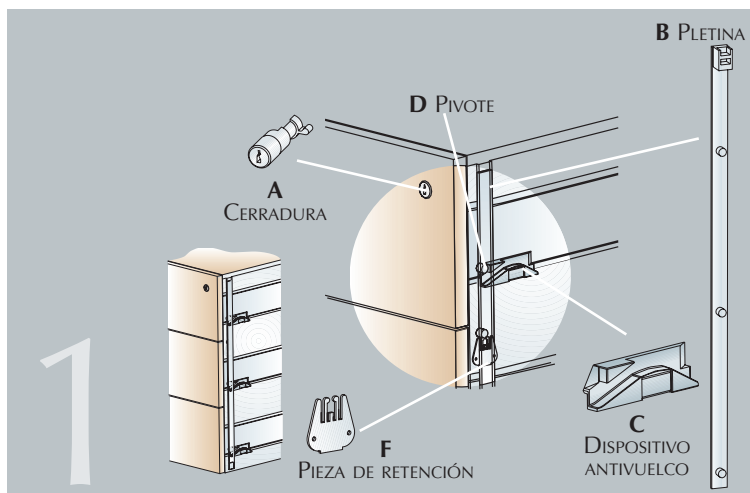
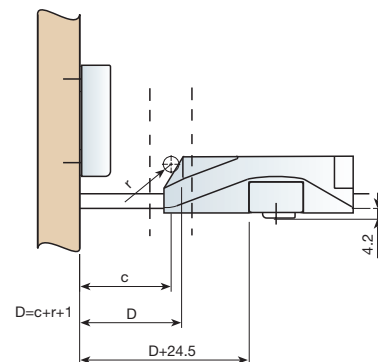
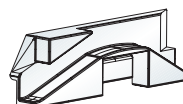

CAJONERA CERRADA, LOS PIVOTES **D** DE LA PLETINA **B** IMPIDEN LA APERTURA DE LOS CAJONES CON EL DISPOSITIVO ANTIVUELCO **C**.

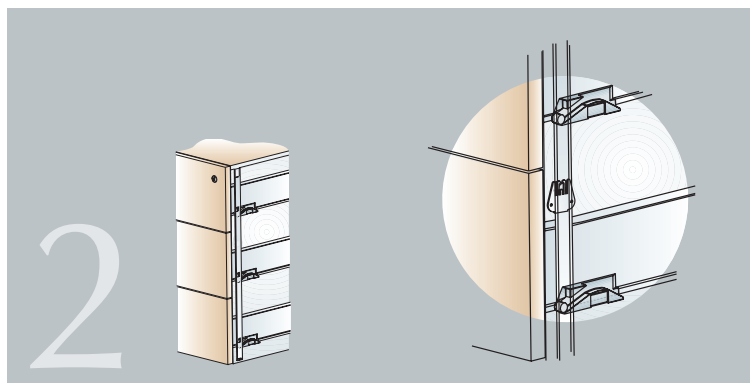

CAJONERA ABIERTA, AL GIRAR LA CERRADURA **A**, LA PLETINA **B** SE DESPLAZA HACIA ABAJO. LOS CAJONES PUEDEN ABRIRSE SIN TROPEZAR CON LOS PIVOTES **D**.

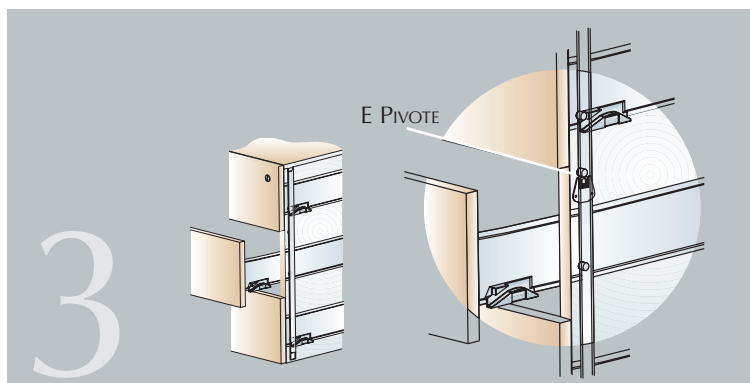

AL ABRIR UN CAJÓN EL DISPOSITIVO ANTIVUELCO **C** ACTÚA SOBRE EL PIVOTE **D** DESPLAZANDO LA PLETINA **B** HACIA ARRIBA. LA PIEZA DE RETENCIÓN **F** IMPIDE QUE LA PLETINA **B** BAJE POR SÍ MISMA SUJETANDO EL PIVOTE **E**. EL RESTO DE CAJONES NO PUEDEN ABRIRSE, PUES LO IMPIDE SU RESPECTIVO PIVOTE **D**. AL CERRARSE EL CAJÓN LA PLETINA **B** BAJA Y PERMITE LA APERTURA DE CUALQUIER CAJÓN.

5 DATOS TÉCNICOS

Taladrado y posicionamiento para la corredera “GACELA”

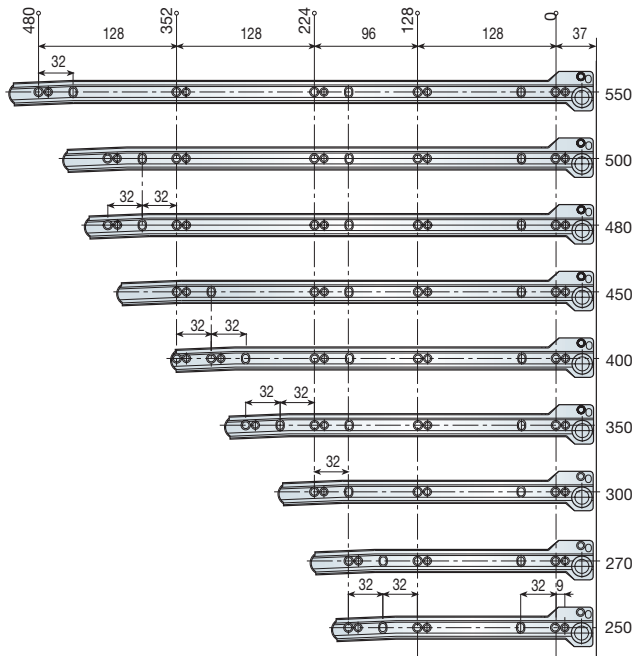

Taladrado y posicionamiento para la corredera “GACELA” telescópica

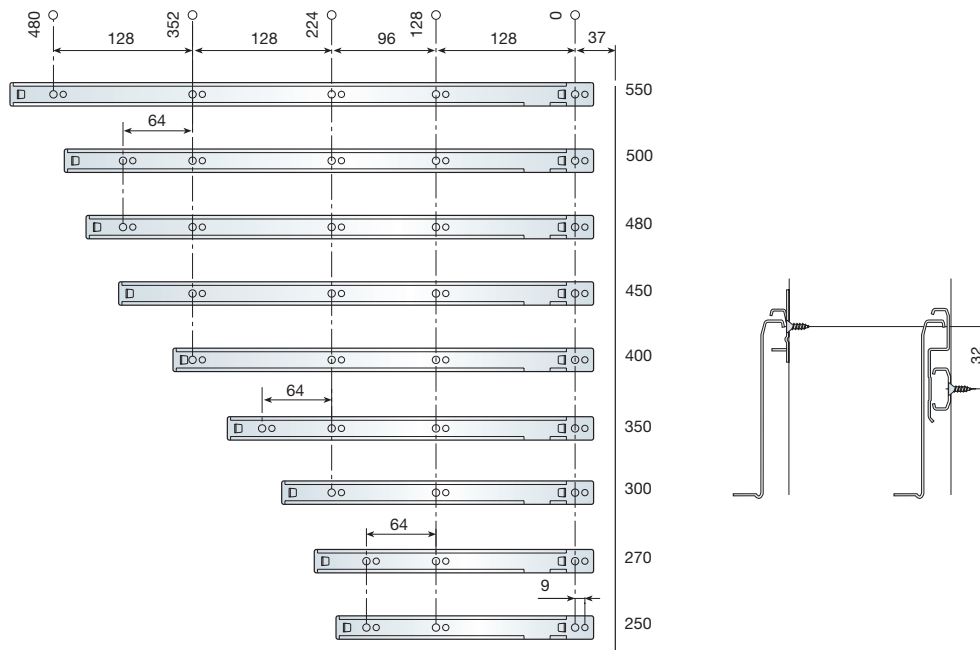

Cálculo de la base

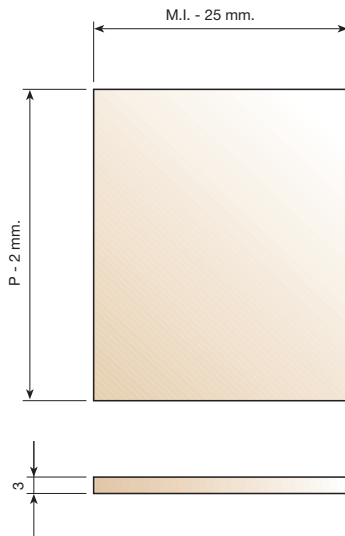

Fijación del frente

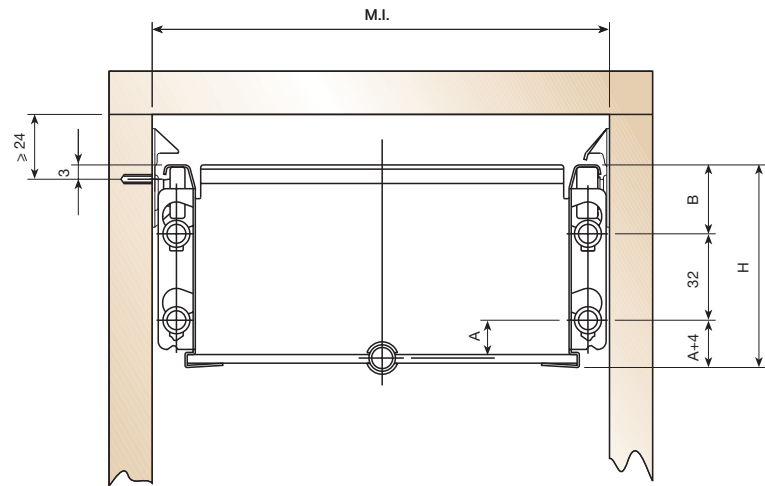

P = PROFUNDIDAD NOMINAL DEL CAJÓN.

M.I. = MEDIDA INTERIOR DEL MUEBLE.

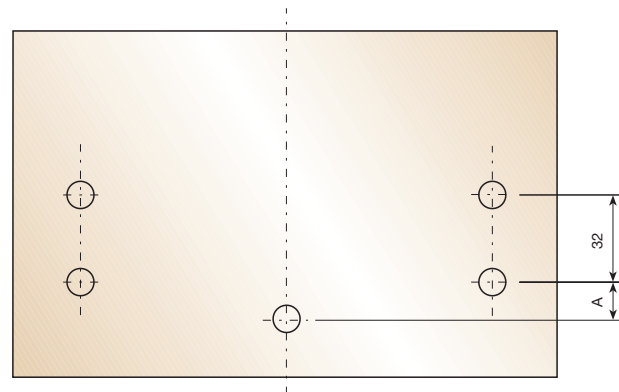

DIMENSIONES (MM.)	H	A	B
"SUPRAPLEX 75"	75	14	25
"SUPRAPLEX 107"	107	46	25
"SUPRAPLEX 139"	139	46	57

