



- NUEVO DISEÑO
- MAYOR LONGITUD
- MAYOR CAPACIDAD

# Cajón "COMBI"

CAJÓN COMPACTO



# Cajón "COMBI" compacto

	<i>págs.</i>
<b>1 CAJÓN "COMBI-275"</b> .....	492
■ CAJONES .....	492
■ CORREDERAS .....	492
■ ENGANCHE DEL FRENTE .....	492
<hr/>	
<b>2 CAJÓN "COMBI-440"</b> .....	493
■ CAJONES .....	493
■ CORREDERAS .....	493
■ ENGANCHE DEL FRENTE .....	494
■ ACCESORIOS CAJÓN CACEROLERO .....	494
■ CUBERTEROS .....	495
<hr/>	
<b>3 CAJÓN "COMBI-480"</b> .....	496
■ CAJONES .....	496
■ CORREDERAS .....	497
■ ENGANCHE DEL FRENTE .....	497
■ ACCESORIOS CAJÓN CACEROLERO .....	498
■ CUBERTEROS .....	498
■ ACCESORIOS .....	499

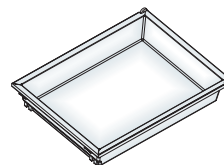

# 1 CAJÓN "COMBI-275"

## CAJONES

CAJÓN "COMBI-275".

MÓDULO	BLANCO RAL 9001	
175	680.417.006	25
200	680.420.005	
250	680.425.001	
300	680.430.004	
350	680.435.000	
400	680.440.003	



## CORREDERAS

CORREDERA.

LONGITUD	PÉRDIDA SALIDA PS	BLANCO RAL 9001	
275	50	788.116.000	100

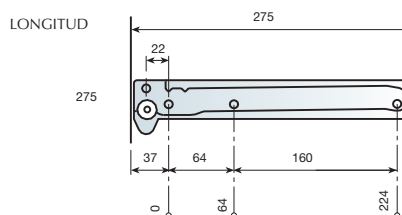
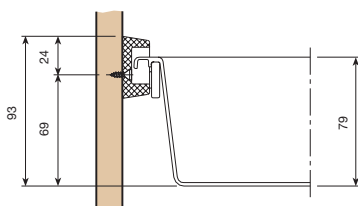

## ENGANCHE DEL FRENTE

ENGANCHE FRONTAL REGULABLE.

	BLANCO RAL 9001	
	685.000.002	100

CADA REFERENCIA SE COMPONE DE UN JUEGO COMPLETO DE ENGANCHE.

ENGANCHE FRONTAL REGULABLE CON ALETAS A 15 MM.

	BLANCO RAL 9001	
	685.200.003	100

CADA REFERENCIA SE COMPONE DE UN JUEGO COMPLETO DE ENGANCHE.

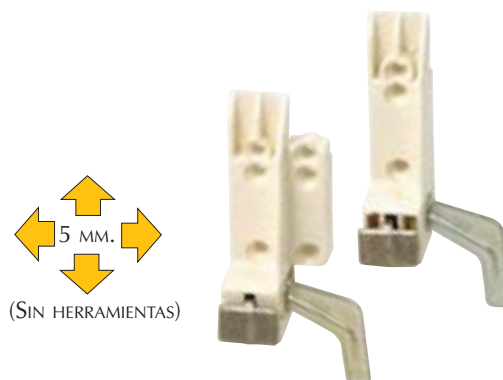

MÓDULO	F
175	37
200	62
250	112
300	162
350	212
400	262

**NOTA**  
PARA LA COLOCACIÓN DEL ENGANCHE CON ALETAS HAY QUE SUMARLE 30 MM. A LA COTA F.

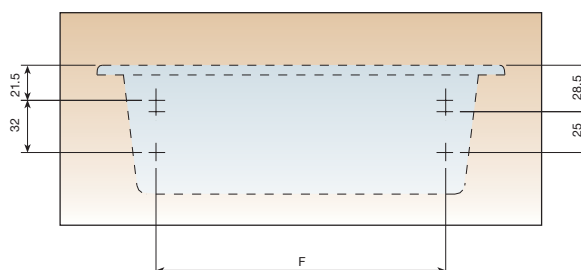

## 2 CAJÓN "COMBI-440"

### CAJONES

#### CAJÓN "COMBI-440".

MÓDULO	BLANCO RAL 9001	BEIGE RAL 1015	
300	680.330.000	680.330.464	25
350	680.335.003	680.335.460	
400	680.340.006	680.340.463	
450	680.345.002	680.345.466	
500	680.350.005	680.350.462	
600	680.360.004	680.360.461	



#### CAJÓN "COMBI-440" "KIT-4".

MÓDULO	BLANCO RAL 9001	BEIGE RAL 1015	
300	681.430.002	681.430.466	1
350	681.435.005	681.435.462	
400	681.440.001	681.440.465	
450	681.445.004	681.445.461	
500	681.450.000	681.450.464	
600	681.460.006	681.460.463	

CADA REFERENCIA SE COMPONE DE 4 CAJONES CON SUS CORRESPONDIENTES CORREDERAS, ENGANCHES, Y TIRAFONDOS.

#### CAJÓN "COMBI-440" "KIT-5".

MÓDULO	BLANCO RAL 9001	BEIGE RAL 1015	
300	681.530.006	681.530.463	1
350	681.535.002	681.535.466	
400	681.540.005	681.540.462	
450	681.545.001	681.545.465	
500	681.550.004	681.550.461	
600	681.560.003	681.560.460	

CADA REFERENCIA SE COMPONE DE 5 CAJONES CON SUS CORRESPONDIENTES CORREDERAS, ENGANCHES, Y TIRAFONDOS.

MÓDULO	ANCHURA	LARGO	ALTO
300	250	435	79
350	300		
400	350		
450	400		
500	450		
600	550		

### CORREDERAS

#### CORREDERAS PARA COSTADO DE 16MM.

PÉRDIDA DE SALIDA PS	BLANCO RAL 9001	BEIGE RAL 1015	
90	789.216.002	789.216.466	100



#### CORREDERAS PARA COSTADO DE 19MM.

PÉRDIDA DE SALIDA PS	BLANCO RAL 9001	BEIGE RAL 1015	
90	789.219.001	789.219.465	100

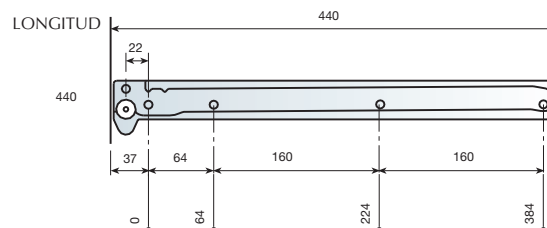
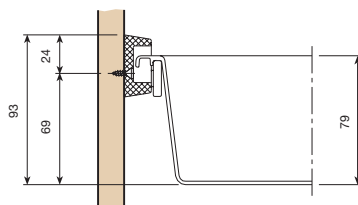

■ **ENGANCHE DEL FRENTE**

ENGANCHE FRONTAL REGULABLE.

BLANCO RAL 9001	BEIGE RAL 1015	
685.000.002	685.000.466	100

CADA REFERENCIA SE COMPONE DE UN JUEGO COMPLETO DE ENGANCHE.

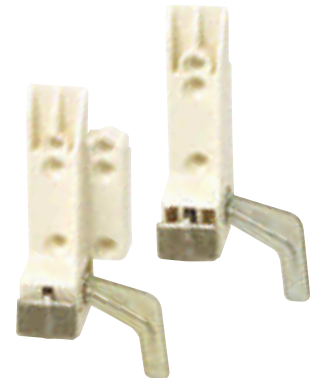

ENGANCHE FRONTAL REGULABLE CON ALETAS A 15 MM.

BLANCO RAL 9001	BEIGE RAL 1015	
685.200.003	685.200.460	100

CADA REFERENCIA SE COMPONE DE UN JUEGO COMPLETO DE ENGANCHE.

MÓDULO	F
300	162
350	212
400	262
450	312
500	362
600	462

**NOTA**

PARA LA COLOCACIÓN DEL ENGANCHE CON ALETAS HAY QUE SUMARLE 30 MM. A LA COTA F.

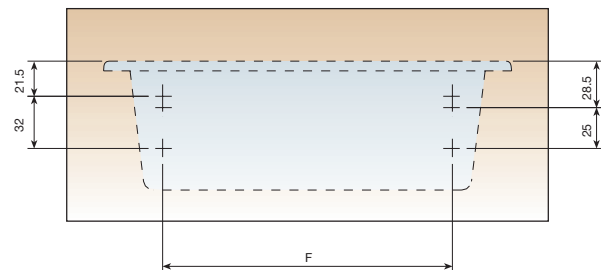

■ **ACCESORIOS CAJÓN CACEROLERO**

CERCO PARA CAJÓN "COMBI-440".

MÓDULO	L	CROMADO	
300	230	745.230.124	20
350	280	745.235.120	
400	330	745.240.123	
450	380	745.245.126	
500	430	745.250.122	
600	530	745.260.121	

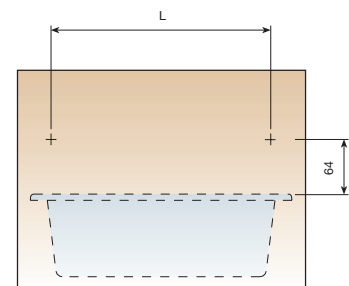
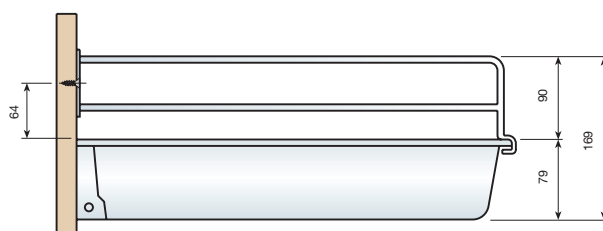

## CUBERTEROS

CUBERTEROS DISEÑADOS PARA MODULACIONES DEL CAJÓN "COMBI". ESTE CUBERTERO SE PRESENTA EN DOS VERSIONES: AJUSTADO EN CUATRO LADOS PARA TODOS LOS MÓDULOS, Y CON FALDÓN LATERAL PARA CAJONES A PARTIR DE MÓDULO 350 Y 450, DANDO UNA MAYOR VERSATILIDAD, YA QUE SIRVE PARA VARIOS MODELOS.

### CUBERTEROS "COMBI - 440".

MÓDULO	BLANCO	BEIGE RAL 1015	MEDIDAS			25
			LARGO	ANCHO	ALTO	
300	687.130.006	687.130.463	391	206	45	25
350	689.035.001	689.035.465	391	256	45	20
400	687.140.005	687.140.462	391	306	45	25
450	689.045.000	689.045.464	391	356	45	20
500	689.050.003	689.050.460	391	406	45	20
600	689.060.002	689.060.466	391	506	45	20

ESTOS CUBERTEROS NO LLEVAN FALDÓN, Y SE AJUSTAN EN LOS CUATRO LADOS DEL CAJÓN DE TODOS LOS MÓDULOS.



### CUBERTERO "COMBI - 440" CON ALETA.

MODELO	MEDIDAS		25
	BLANCO	BEIGE RAL 1015	
350	687.135.002	687.135.466	25
450	687.145.001	687.145.465	25

ESTOS CUBERTEROS LLEVAN FALDÓN, Y SIRVEN PARA CAJONES A PARTIR DEL MÓDULO 350 Y 450 RESPECTIVAMENTE.



### 3 CAJÓN "COMBI-480"

#### CAJONES

##### CAJÓN "COMBI - 480".

MÓDULO	BLANCO RAL 9001	GRIS METALIZADO	
300	681.030.000	681.030.313	25
350	681.035.003	681.035.316	
400	681.040.006	681.040.312	
450	681.045.002	681.045.315	
500	681.050.005	681.050.311	
600	681.060.004	681.060.310	

ESTOS CUBERTEROS LLEVAN FALDÓN, Y SIRVEN PARA CAJONES A PARTIR DEL MÓDULO 350 Y 450 RESPECTIVAMENTE.

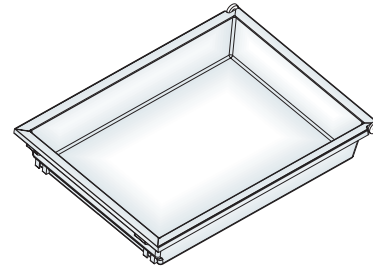

##### CAJÓN "COMBI - 480" "KIT-4".

MÓDULO	BLANCO RAL 9001	GRIS METALIZADO	
300	681.130.004	681.130.310	1
350	681.135.000	681.135.313	
400	681.140.003	681.140.316	
450	681.145.006	681.145.312	
500	681.150.002	681.150.315	
600	681.160.001	681.160.314	

CADA REFERENCIA SE COMPONE DE 4 CAJONES CON SUS CORRESPONDIENTES CORREDERAS, ENGANCHES Y TIRAFONDOS.

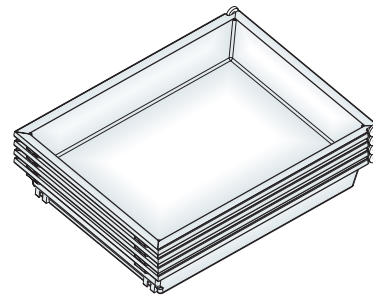

##### CAJÓN "COMBI - 480" "KIT-5".

MÓDULO	BLANCO RAL 9001	GRIS METALIZADO	
300	681.230.001	681.230.314	1
350	681.235.004	681.235.310	
400	681.240.000	681.240.313	
450	681.245.003	681.245.316	
500	681.250.006	681.250.312	
600	681.260.005	681.260.311	

CADA REFERENCIA SE COMPONE DE 5 CAJONES CON SUS CORRESPONDIENTES CORREDERAS, ENGANCHES Y TIRAFONDOS.

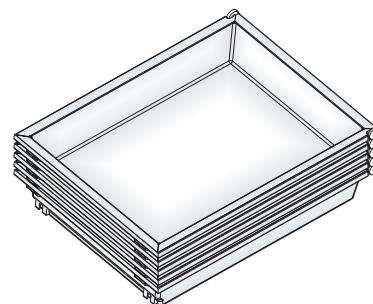



**CORREDERAS**

CORREDERA COSTADO 16MM.

Ps	BLANCO RAL 9001	GRIS METALIZADO	
90	788.316.001	788.316.314	100

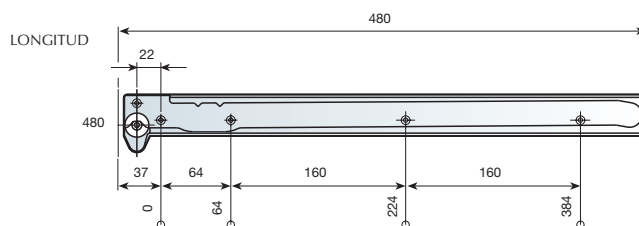
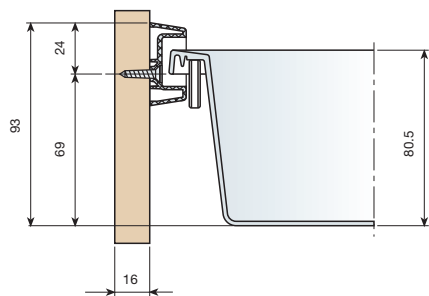

**ENGANCHE DEL FRENTE**

ENGANCHE FRONTAL REGULABLE.

	BLANCO RAL 9001	GRIS METALIZADO	
	685.000.002	685.000.315	100

CADA REFERENCIA SE COMPONE DE UN JUEGO COMPLETO DE ENGANCHES.

ENGANCHE FRONTAL REGULABLE CON ALETAS A 15MM.

	BLANCO RAL 9001	GRIS METALIZADO	
	685.200.003	685.200.316	100

CADA REFERENCIA SE COMPONE DE UN JUEGO COMPLETO DE ENGANCHES.

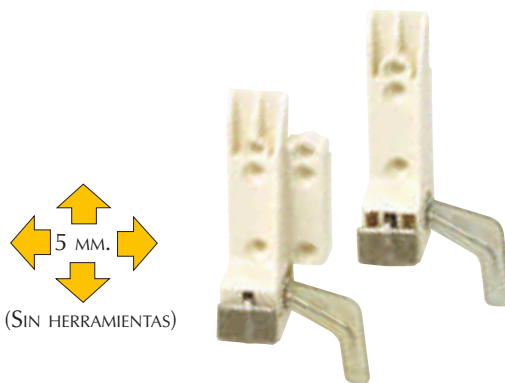

MÓDULO	F
300	162
350	212
400	262
450	312
500	362
600	462

**NOTA**

PARA LA COLOCACIÓN DEL ENGANCHE CON ALETAS HAY QUE SUMARLE 30 MM. A LA COTA F.

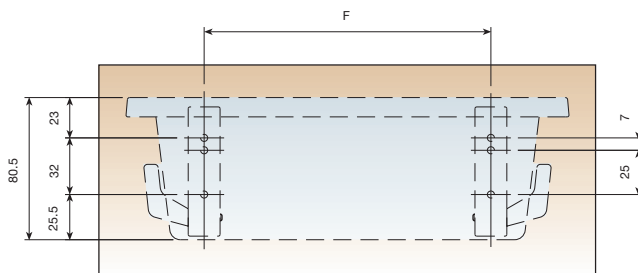

■ ACCESORIOS CAJÓN CACEROLERO

CERCO PARA CAJÓN "COMBI-480".

MÓDULO	L	CROMADO	
300	230	745.330.121	20
350	280	745.335.124	
400	330	745.340.120	
450	380	745.345.123	
500	430	745.350.126	
600	530	745.360.125	

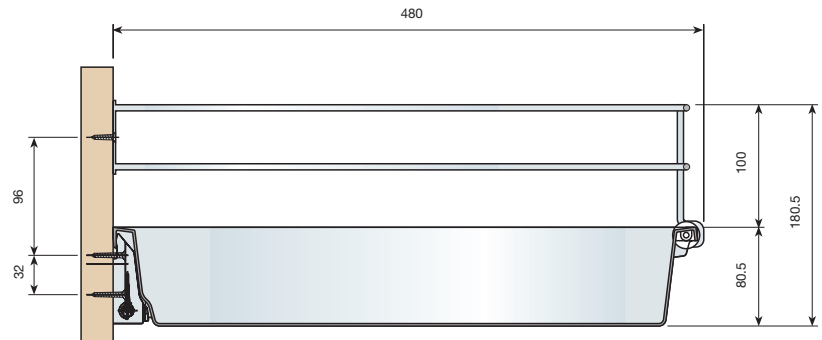
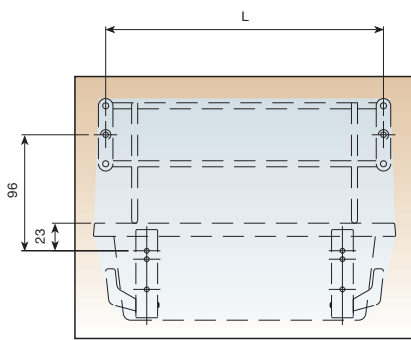
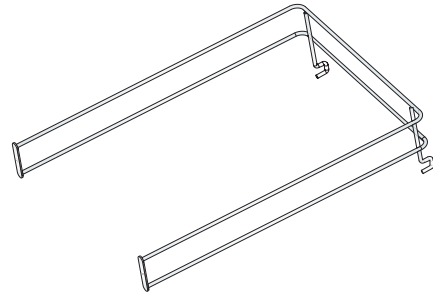

■ CUBERTEROS

CUBERTERO "COMBI-480".

MÓDULO	BLANCO RAL 9001	GRIS METALIZADO	
300*	687.930.003	687.930.316	20
350	687.635.001	687.635.314	
400*	687.940.002	687.940.315	
450	687.645.000	687.645.313	
500	687.650.003	687.650.316	
600	687.660.002	687.660.315	

\*SE SUMINISTRA EN CAJAS DE 25 UNIDADES.

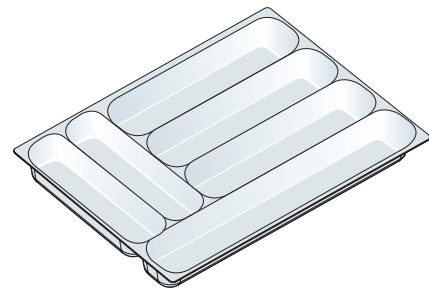

CUBERTERO "COMBI-480" CON ALETA.

MÓDULO	BLANCO RAL 9001	GRIS METALIZADO	
350	687.935.006	687.935.312	25
450	687.945.005	687.945.311	

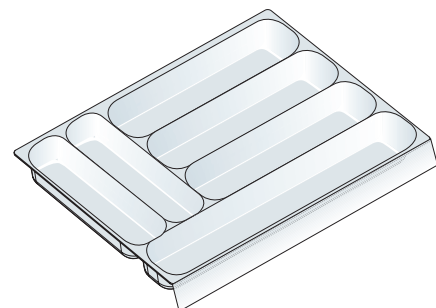

■ **ACCESORIOS:** *Esterilla antideslizante*

ESTERILLA ANTIDESLIZANTE PARA DEPOSITAR EN TODOS LOS CAJONES, ESPECIALMENTE CACEROLEROS Y EVITAR DE ESTA MATERA EL DESPLAZAMIENTO DE LOS ELEMENTOS DE COCINA Y EL RAYADO DEL FONDO. SE PUEDE CORTAR DIRECTAMENTE DEL ROLLO A LA MEDIDA DEL CAJÓN.

ESTERILLA ANTIDESLIZANTE.

GRIS	443.050.300	1
------	-------------	---



SE SUMINISTRA EN ROLLOS DE 20 MTS. DE LONGITUD Y 500 MM. DE ANCHO.  
PARA PEDIDOS SUPERIORES A 100 PIEZAS, ESTAS ESTERILLAS PUEDEN SER SUMINISTRADAS CORTADAS A MEDIDAS FIJAS.

