



**INDA**matic

MODULACIONES 300 A 900 MM.  
4 OPCIONES DE CORREDERA INVISIBLE.  
CIERRE AMORTIGUADO.

# Cajón "EUROPA"





COMPACTO





# Cajón "EUROPA" compacto

MODULACIONES 300 A 900 MM. 4 OPCIONES DE CORREDERA INVISIBLE.  
CIERRE AMORTIGUADO INDAMATIC.

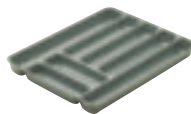
	págs.
<b>1 COMPONENTES</b> .....	462
<ul style="list-style-type: none"> <li>■ CAJONES .....</li> <li style="padding-left: 20px;">Acero inoxidable .....</li> <li style="padding-left: 20px;">Recubierto metálico .....</li> <li style="padding-left: 20px;">Inyectado .....</li> </ul>	 462 462 462 463
<ul style="list-style-type: none"> <li>■ CAJÓN COMPONIBLE PARA MÁS DIMENSIONES .....</li> </ul>	 464
<ul style="list-style-type: none"> <li>■ PROGRAMA DE CORREDERAS .....</li> <li style="padding-left: 20px;">Extracción parcial .....</li> <li style="padding-left: 20px;">Extracción total .....</li> </ul>	 465 465 467
<ul style="list-style-type: none"> <li>■ ENGANCHE DEL FRENTE .....</li> </ul>	 468
<hr/>	
<b>2 ACCESORIOS</b> .....	468
<ul style="list-style-type: none"> <li>■ ACCESORIOS CAJÓN CACEROLERO .....</li> <li>■ CUBERTEROS .....</li> <li>■ EMBELLECEDOR LATERAL DEL CAJÓN INYECTADO .....</li> <li>■ ESTERILLA .....</li> </ul>	 468 469 469 469

## 1 COMPONENTES

### ■ CAJON: Acero inoxidable

#### CAJÓN DE ACERO INOXIDABLE.

MÓDULO	INOXIDABLE	
300	684.030.104	10
350	684.035.100	
400	684.040.103	
450	684.045.106	
500	684.050.102	
600	684.060.101	



### ■ CAJON: Recubierto metálico

#### CAJÓN DE ACERO RECUBIERTO.

MÓDULO	BLANCO RAL 9001	GRIS	MADERA MAPLE-MIEL	
300	684.130.005	684.130.311	684.130.904	10
350	684.135.001	684.135.314	684.135.900	
400	684.140.004	684.140.310	684.140.903	
450	684.145.000	684.145.313	684.145.906	
500	684.150.003	684.150.316	684.150.902	
600	684.160.002	684.160.315	684.160.901	



#### CAJÓN DE ACERO RECUBIERTO EN "KIT-5".

MÓDULO	GRIS	
300	684.430.316	1
350	684.435.312	
400	684.440.315	
450	684.445.311	
500	684.450.314	
600	684.460.313	

LOS CONJUNTOS KIT SE COMPONEN DE 5 CAJONES CON SUS CORRESPONDIENTES CORREDERAS "MARC" CON AUTOCIERRE DE EXTRACCIÓN PARCIAL, ENGANCHES Y TIRAFONDOS.

■ CAJÓN: *Inyectado*

CAJÓN INYECTADO.

MÓDULO	BLANCO RAL 9001	GRIS RAL 7040	
300	684.530.000	684.530.313	20
350	684.535.003	684.535.316	
400	684.540.006	684.540.312	
450	684.545.002	684.545.315	
500	684.550.005	684.550.311	
600	684.560.004	684.560.310	
900	684.590.001	684.590.314	10



CAJÓN INYECTADO EN KIT BLANCO RAL 9001.

MÓDULO	KIT 4 CAJONES	KIT 5 CAJONES	
300	684.830.005	684.930.002	1
350	684.835.001	684.935.005	
400	684.840.004	684.940.001	
450	684.845.000	684.945.004	
500	684.850.003	684.950.000	
600	684.860.002	684.960.006	
900	684.890.006	684.990.003	

LOS CONJUNTOS KIT SE COMPONEN DE 4 Ó 5 CAJONES CON SUS CORRESPONDIENTES CORREDERAS "MARC" CON AUTOCIERRE DE EXTRACCIÓN PARCIAL, ENGANCHES Y TIRAFONDOS.

CAJÓN-CUBERTERO.

MÓDULO	BLANCO RAL 9001	GRIS RAL 7040	
300	684.630.004	684.630.310	20
350	684.635.000	684.635.313	
400	684.640.003	684.640.316	
450	684.645.006	684.645.312	
500	684.650.002	684.650.315	
600	684.660.001	684.660.314	



CAJÓN-CUBERTERO CON BANDEJA.

MÓDULO	BLANCO RAL 9001	GRIS RAL 7040	
300	684.730.001	684.730.314	5
350	684.735.004	684.735.310	
400	684.740.000	684.740.313	
450	684.745.003	684.745.316	
500	684.750.006	684.750.312	
600	684.760.005	684.760.311	



■ CAJÓN COMPONIBLE PARA MÁS DIMENSIONES

LATERALES INYECTADOS.

L. DE CAJÓN	BLANCO RAL 9001	GRIS RAL 7040	
270	683.327.002	683.327.315	
400	683.340.000	683.340.313	20
480	683.348.002	683.348.315	

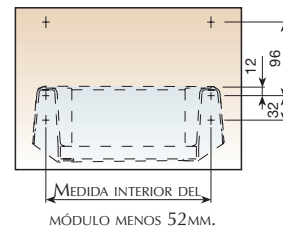
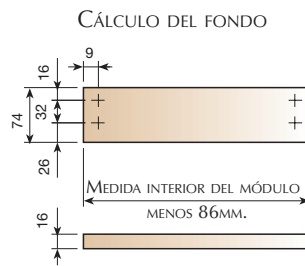
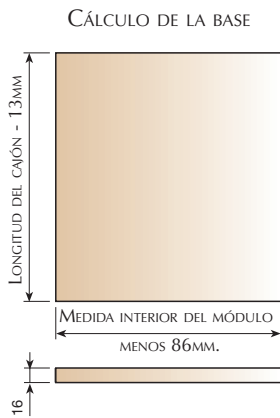

LATERALES DE ALUMINIO.

L. DE CAJÓN	ANODIZADO PLATA	
270	683.427.511	
400	683.440.516	20
480	683.448.511	

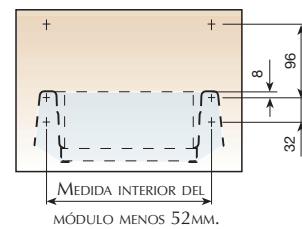
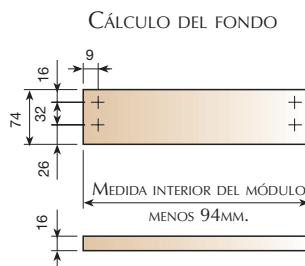
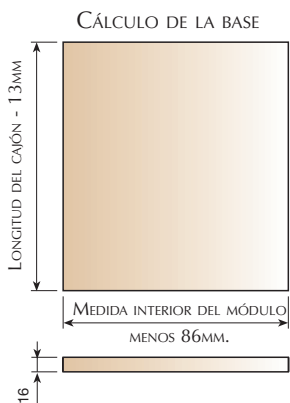

**PROGRAMA DE CORREDERAS: Extracción parcial**

CORREDERA "MARC" CON CAIDA.

LONGITUD	PÉRDIDA DE SALIDA	REF. COSTADO	
	PS	16 MM.	
270	60	768.527.034	20
400	80	768.540.032	
480	90	768.548.034	
520	50	768.552.035	



ALOJAMIENTO PANEL		
MÓDULO	F	LONG
300	160	408
350	210	
400	260	
450	310	
500	360	
600	460	

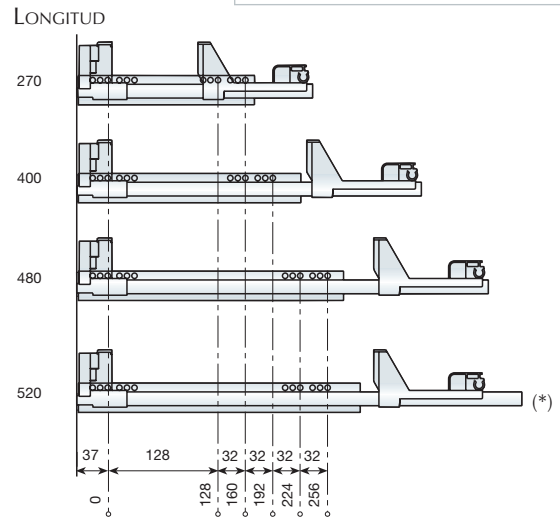
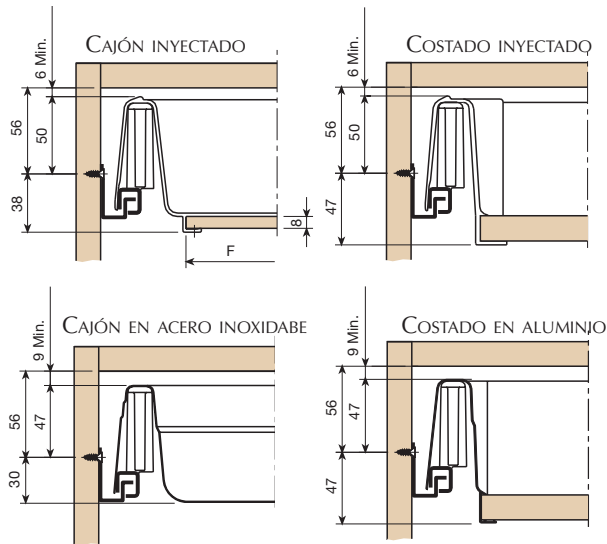

**PROGRAMA DE CORREDERAS: Extracción parcial**

CORREDERA "MARC" CON AUTOCIERRE.

LONGITUD	PÉRDIDA DE SALIDA	REF. COSTADO	REF. COSTADO	
	PS	15÷16 MM.	18÷19 MM.	
270	55	767.127.034	768.127.032	20
400	75	767.140.032	768.140.030	
480	75	767.148.034	768.148.032	
520	EXTRACCIÓN TOTAL	767.152.035	768.152.033	

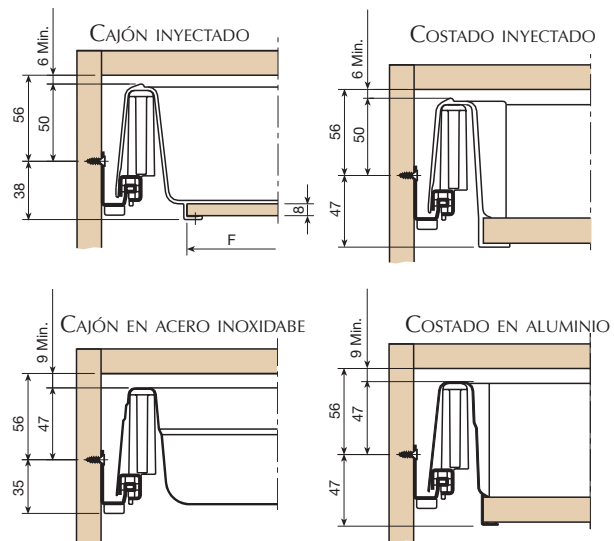

ALOJAMIENTO PANEL		
MÓDULO	F	LONG
300	160	408
350	210	
400	260	
450	310	
500	360	
600	460	

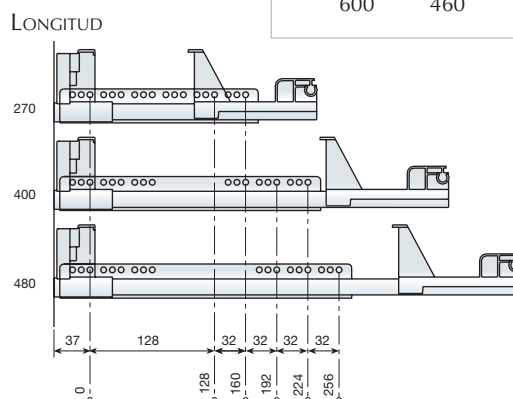

CORREDERA "MARC" CON AMORTIGUACIÓN Y AUTOCIERRE.

LONGITUD	PÉRDIDA DE SALIDA	REF. COSTADO	
	PS	16 MM.	
270	60	768.827.032	20
400	80	768.840.030	
480	90	768.848.032	
520	50	768.852.033	

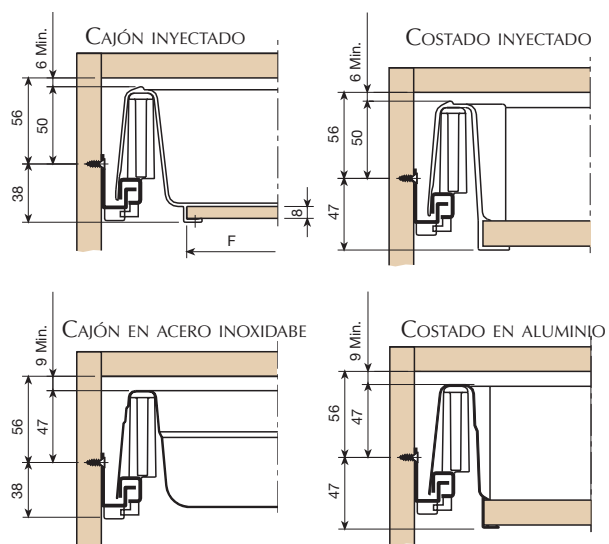

**INDAmatic**  
cierre progresivo

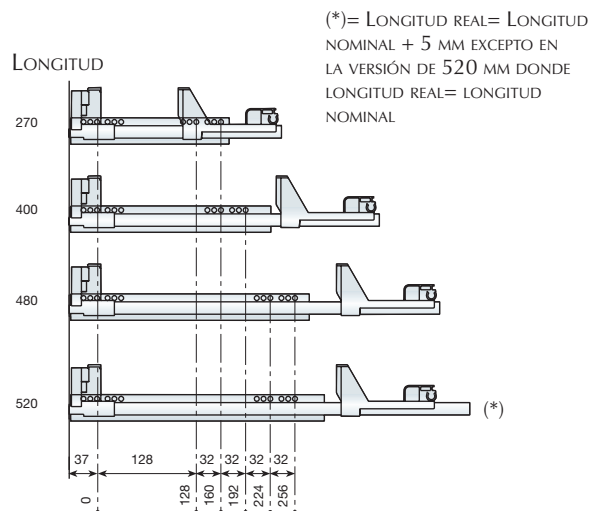



**PROGRAMA DE CORREDERAS: Extracción total**

CORREDERA "MARC" TELESCÓPICA CON AUTOCIERRE.

LONGITUD	PÉRDIDA DE SALIDA	REF. COSTADO	REF. COSTADO	
	PS	15÷16 MM.	18÷19 MM.	
270	0	767.327.035	768.327.033	
400	0	767.340.033	768.340.031	10
480	0	767.348.035	768.348.033	

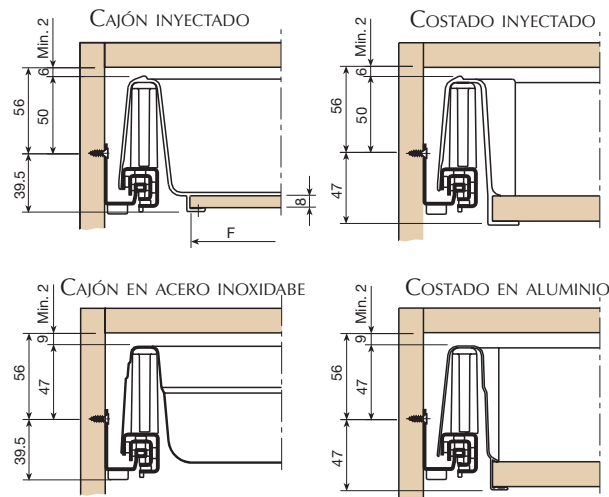

ALOJAMIENTO PANEL		
MÓDULO	F	LONG
300	160	
350	210	
400	260	408
450	310	
500	360	
600	460	

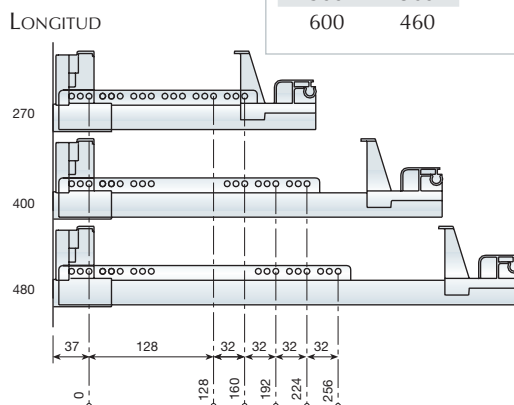

CORREDERA "MARC" TELESCÓPICA CON AUTOCIERRE Y AMORTIGUACIÓN.

LONGITUD	PÉRDIDA DE SALIDA	REF. COSTADO	REF. COSTADO	
	PS	15÷16 MM.	18÷19 MM.	
270	0	767.427.032	768.427.030	
400	0	767.440.030	768.440.035	10
480	0	767.448.032	768.448.030	

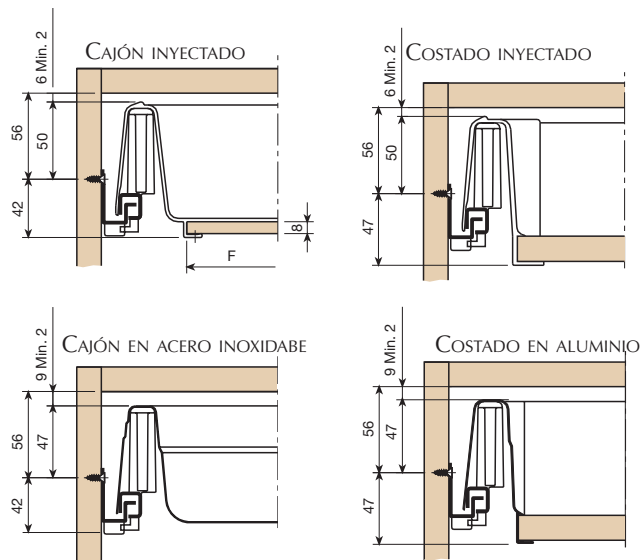

**INDA**matic  
cierre progresivo



(\*)= LONGITUD REAL= LONGITUD NOMINAL + 5 MM EXCEPTO EN LA VERSIÓN DE 520 MM DONDE LONGITUD REAL= LONGITUD NOMINAL

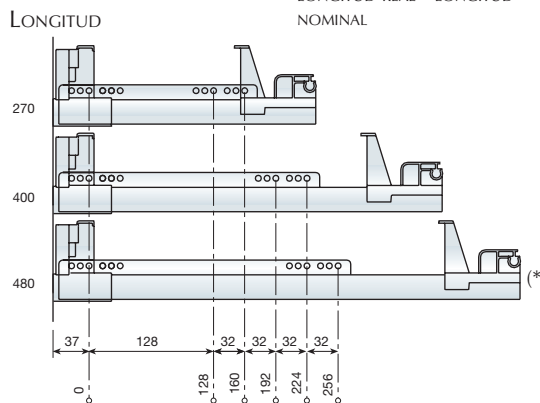

## ENGANCHE DEL FRENTE

### ENGANCHE DEL FRENTE.

ACABADO	REFERENCIA	CANTIDAD
NATURAL	685.900.106	100

CADA REFERENCIA SE COMPONE DE UN JUEGO DE ENGANCHES.

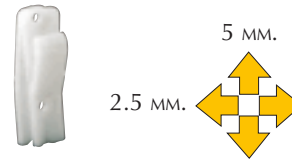

MÓDULO	F
300	216
350	266
400	316
450	366
500	416
600	516
700	616
800	716
900	816

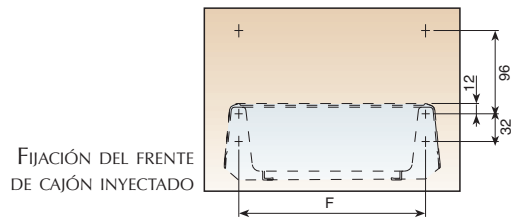

FIJACIÓN DEL FRENTE DE CAJÓN INOXIDABLE RECUBIERTO.

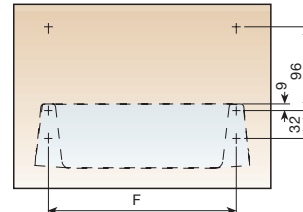

## 2 ACCESORIOS

### ACCESORIOS CAJÓN CACEROLERO

#### CERCO CROMADO.

MÓDULO	REFERENCIA	CANTIDAD
300	743.330.125	20
350	743.335.121	
400	743.340.124	
450	743.345.120	
500	743.350.123	
600	743.360.122	
700	743.370.121	
800	743.380.120	
900	743.390.126	

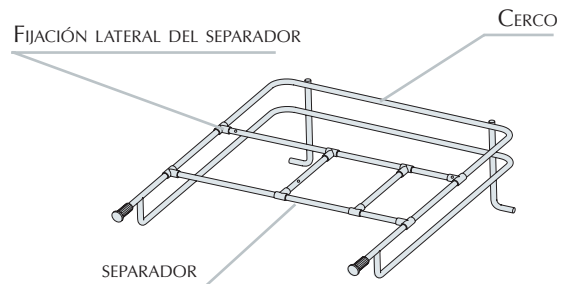

#### SEPARADOR CROMADO.

MÓDULO	REFERENCIA	CANTIDAD
300	745.830.120	50
350	745.835.123	
400	745.840.126	
450	745.845.122	
500	745.850.125	
600	745.860.124	
700	745.870.123	
800	745.880.122	
900	745.890.121	



#### FIJACIÓN LATERAL DEL SEPARADOR.

ACABADO	REFERENCIA	CANTIDAD
GRIS RAL 7037	732.401.305	100

#### ENGANCHE FRONTAL DEL CERCO LATERAL.

ACABADO	REFERENCIA	CANTIDAD
GRIS RAL 7037	730.600.301	100

CADA REFERENCIA SE COMPONE DE UN JUEGO COMPLETO DE ENGANCHES.

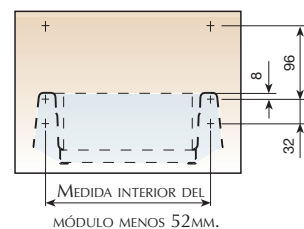

## CUBERTEROS

### CUBERTERO PARA CAJÓN INYECTADO, INOX Y ACERO.

MÓDULO	BLANCO RAL 9001	GRIS RAL 7037	MADERA MAPLE-MIEL	
300	687.530.001	687.530.303	687.530.911	20
350	687.535.004	687.535.306	687.535.914	
400	687.540.000	687.540.302	687.540.910	
450	687.545.003	687.545.305	687.545.913	
500	687.550.006	687.550.301	687.550.916	
600	687.560.005	687.560.300	687.560.915	

CADA REFERENCIA SE COMPONE DE UN JUEGO DE ENGANCHES.



### CUBERTERO PARA CAJÓN INYECTADO.

MÓDULO	BLANCO	GRIS METALIZADO	
900	687.590.002	687.590.142	10



## EMBELLECEDOR LATERAL DEL CAJÓN INYECTADO

### EMBELLECEDOR LATERAL PARA CAJÓN INYECTADO.

ACABADO	REFERENCIA	
ANODIZADO BRILLO	664.548.500	100

CADA REFERENCIA SE COMPONE DE UN JUEGO COMPLETO DE EMBELLECEDORES.



## ESTERILLA

### ESTERILLA PARA CAJÓN INOX Y ACERO.

MÓDULO	GRIS RAL 7037	
300	443.130.306	20
350	443.135.302	
400	443.140.305	
450	443.145.301	
500	443.150.304	
600	443.160.303	
900	443.190.300	

