

LONG LIFE 30.000 h

# LINEO

extractores en línea para conductos **SODECA**

NOVEDAD



**SODECA**<sup>®</sup>



by



**CARACTERÍSTICAS GENERALES**

- Tamaño reducido
- Fabricados en material plástico auto-extinguible V0
- Exclusivo cierre doble palanca que permite extraer el cuerpo en pocos segundos
- Cuerpo extraíble, sin necesidad de mover los conductos
- Caja de bornes externa, con posición variable
- Instalación rápida y sencilla

**Características técnicas del motor**

- Rodamientos a bolas de larga duración
- Equipados con dos velocidades claramente diferenciadas
- Protección contra chorro de agua IP X4
- Motores regulables
- Tensión de alimentación 230V. 50/60Hz

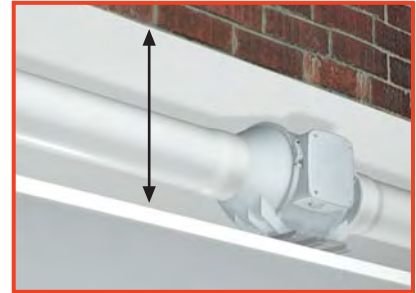
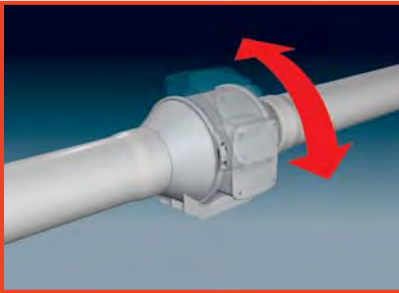

SEGURIDAD GARANTIZADA  
Y CERTIFICADA POR IMQ

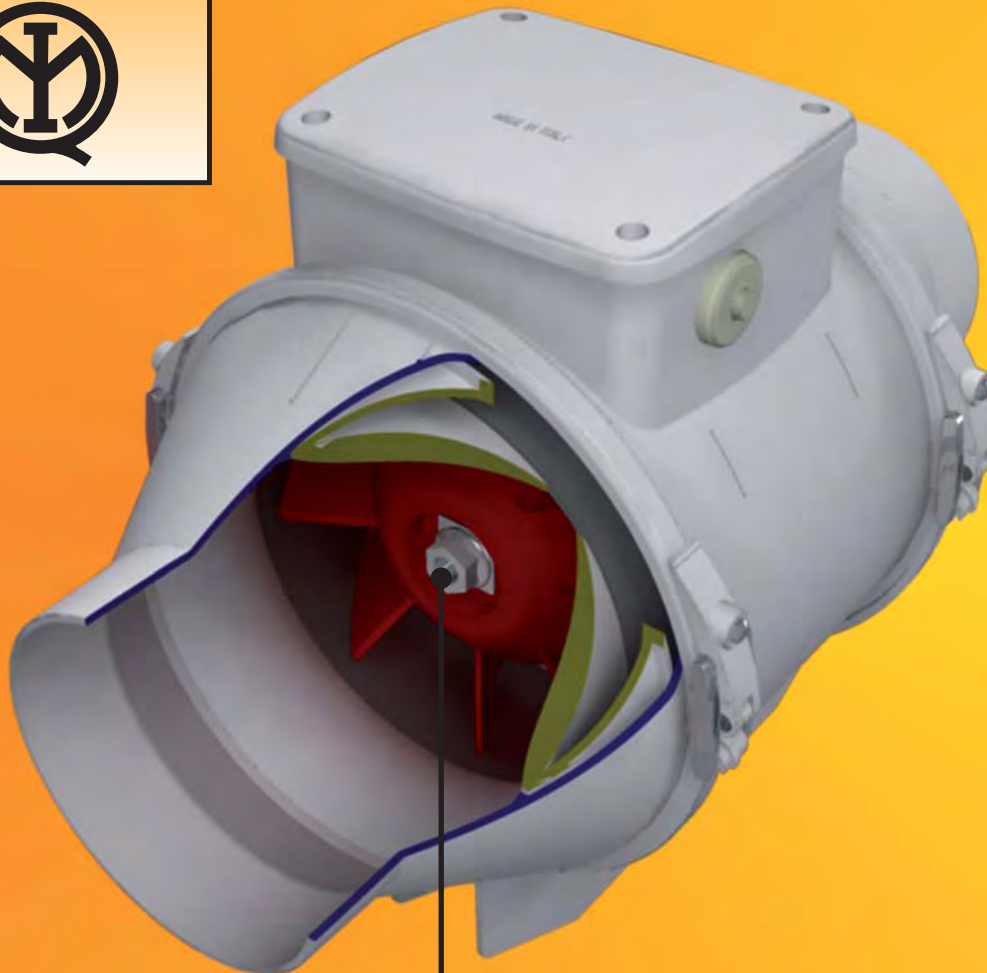

Rodamientos

**LARGA DURACIÓN** 30.000 h

**IPX4**



**2 velocidades** 

**LONG LIFE** 30.000 h

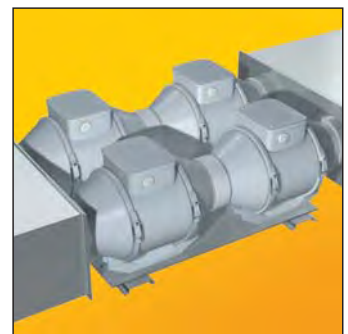
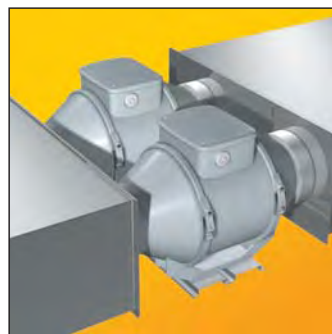
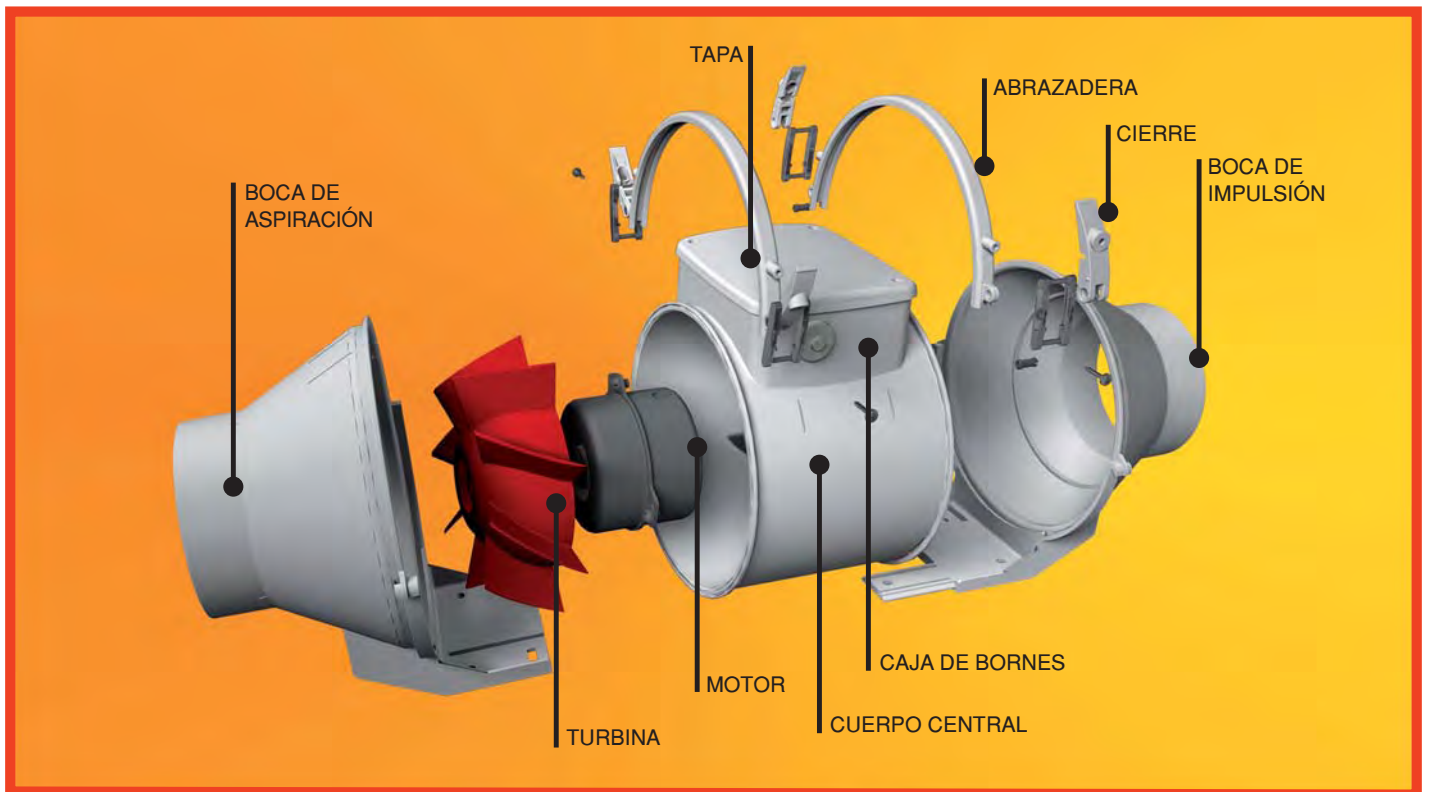

## LINEO 100 Q



Modelos  
LINEO 100 Q  
LINEO 100 Q T

### Características técnicas

Velocidad (r/min)	Voltaje (V)	Int. Máxima (A)	Potencia Absorbida (W)
2620/2070	220-240	0,07/0,05	15/12

Caudal máximo (m³/h)	Nivel de presión sonora irradiado (dB(A))	Peso aprox. (Kg)	Temperatura máxima (°C)
200/155	29/25	1,2	60

### Curvas características

Velocidad  
Max —  
Min —

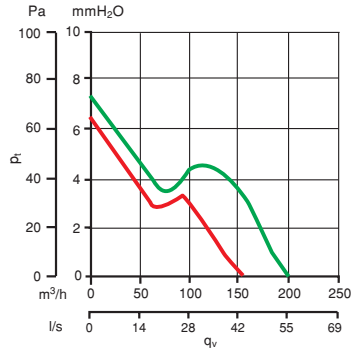

## LINEO 100



Modelos  
LINEO 100  
LINEO 100 T

### Características técnicas

Velocidad (r/min)	Voltaje (V)	Int. Máxima (A)	Potencia Absorbida (W)
2170/1590	220-240	0,11/0,09	23/20

Caudal máximo (m³/h)	Nivel de presión sonora irradiado (dB(A))	Peso aprox. (Kg)	Temperatura máxima (°C)
255/180	30/25	1,2	60

### Curvas características

Velocidad  
Max —  
Min —

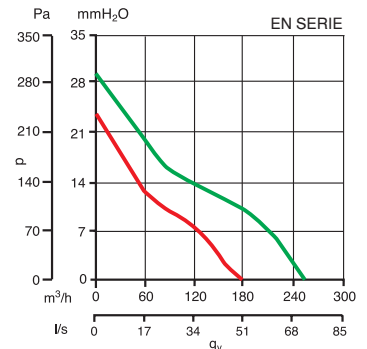
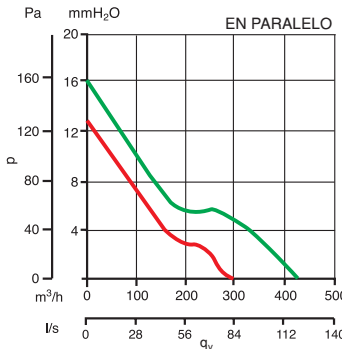
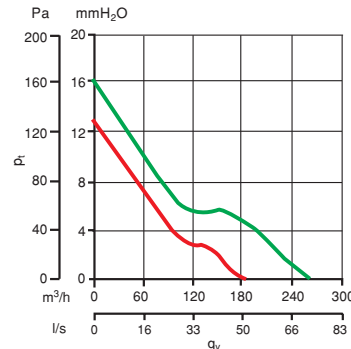

## LINEO 125



Modelos  
LINEO 125  
LINEO 125 T

### Características técnicas

Velocidad (r/min)	Voltaje (V)	Int. Máxima (A)	Potencia Absorbida (W)
2300/1600	220-240	0,15/0,11	33/25

Caudal máximo (m³/h)	Nivel de presión sonora irradiado (dB(A))	Peso aprox. (Kg)	Temperatura máxima (°C)
365/250	33/27	1,7	60

### Curvas características

Velocidad  
Max —  
Min —

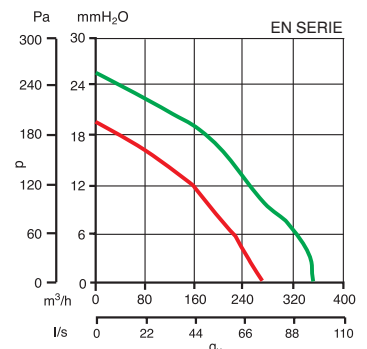
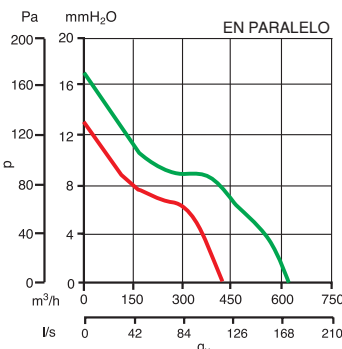
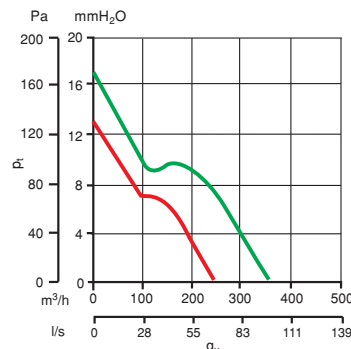



# LINEO 150



Modelos  
LINEO 150  
LINEO 150 T

### Características técnicas

Velocidad (r/min)	Voltaje (V)	Int. Máxima (A)	Potencia Absorbida (W)
2290/1520	220-240	0,26/0,18	58/40

Caudal máximo (m³/h)	Nivel de presión sonora irradiado (dB(A))	Peso aprox. (Kg)	Temperatura máxima (°C)
550/385	33/28	2,3	60

### Curvas características

Velocidad  
Max — (green)  
Min — (red)

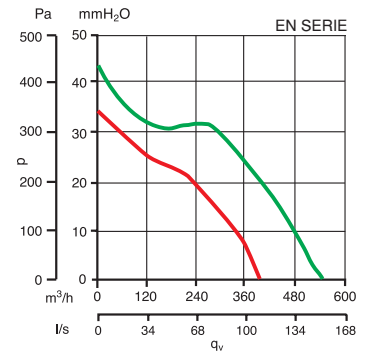
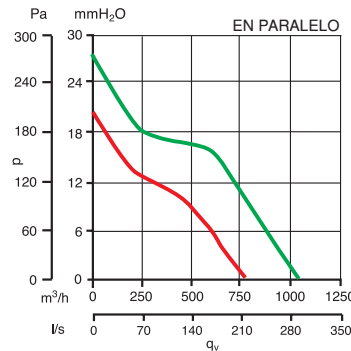
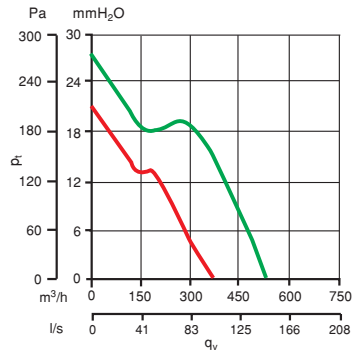

# LINEO 160



Modelos  
LINEO 160  
LINEO 160 T

### Características técnicas

Velocidad (r/min)	Voltaje (V)	Int. Máxima (A)	Potencia Absorbida (W)
2290/1520	220-240	0,26/0,18	58/40

Caudal máximo (m³/h)	Nivel de presión sonora irradiado (dB(A))	Peso aprox. (Kg)	Temperatura máxima (°C)
550/385	34/28	2,3	60

### Curvas características

Velocidad  
Max — (green)  
Min — (red)

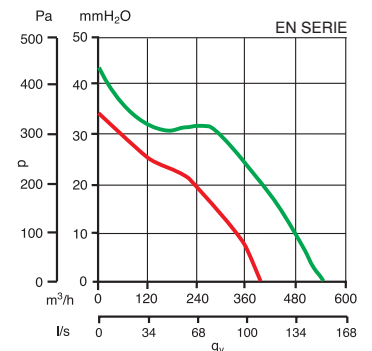
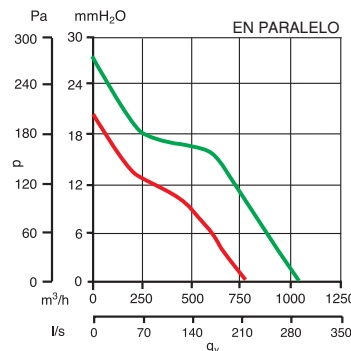
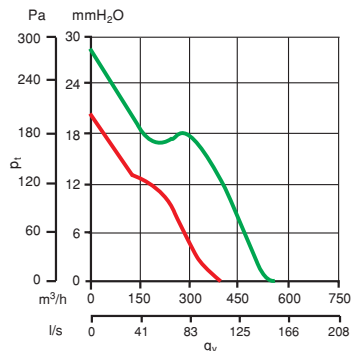

# LINEO 200



Modelos  
LINEO 200  
LINEO 200 T

### Características técnicas

Velocidad (r/min)	Voltaje (V)	Int. Máxima (A)	Potencia Absorbida (W)
2390/1900	220-240	0,64/0,43	145/98

Caudal máximo (m³/h)	Nivel de presión sonora irradiado (dB(A))	Peso aprox. (Kg)	Temperatura máxima (°C)
1060/790	38/32	2,3	60

### Curvas características

Velocidad  
Max — (green)  
Min — (red)

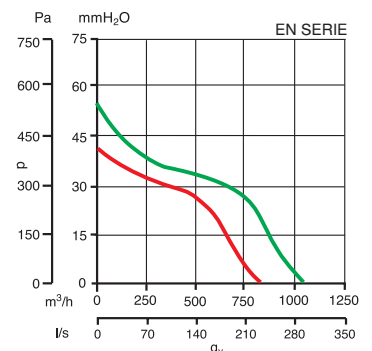
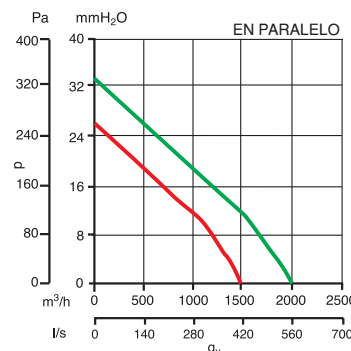
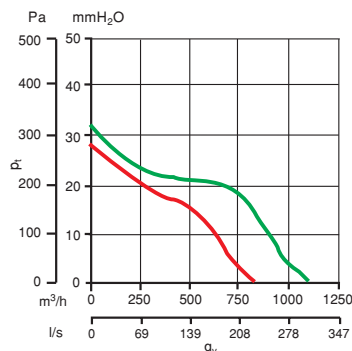

## LINEO 250



Modelo  
LINEO 250

### Características técnicas

Velocidad (r/min)	Voltaje (V)	Int. Máxima (A)	Potencia Absorbida (W)
2640/1950	220-240	0,78/0,48	180/110
Caudal máximo (m³/h)	Nivel de presión sonora irradiado (dB(A))	Peso aprox. (Kg)	Temperatura máxima (°C)
1350/990	40/38	7	60

### Curvas características

Velocidad  
Max — (green)  
Min — (red)

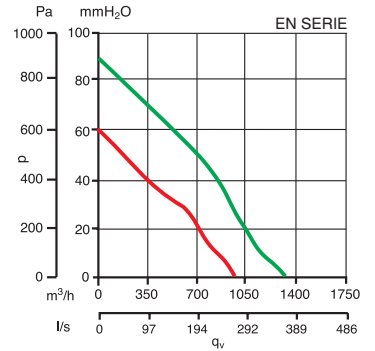
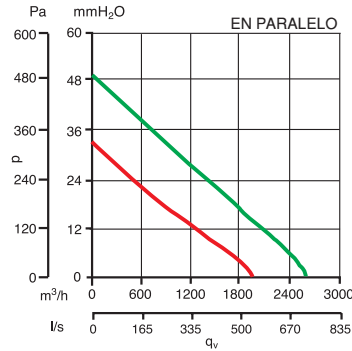
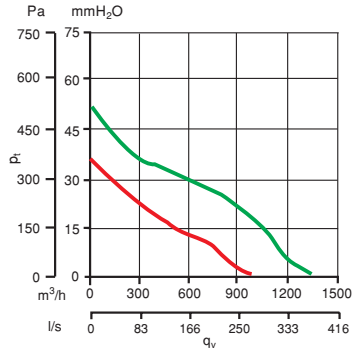

## LINEO 315



Modelo  
LINEO 315

### Características técnicas

Velocidad (r/min)	Voltaje (V)	Int. Máxima (A)	Potencia Absorbida (W)
2500/1820	220-240	1,32/0,90	300/200
Caudal máximo (m³/h)	Nivel de presión sonora irradiado (dB(A))	Peso aprox. (Kg)	Temperatura máxima (°C)
2270/1580	47/41	11,5	60

### Curvas características

Velocidad  
Max — (green)  
Min — (red)

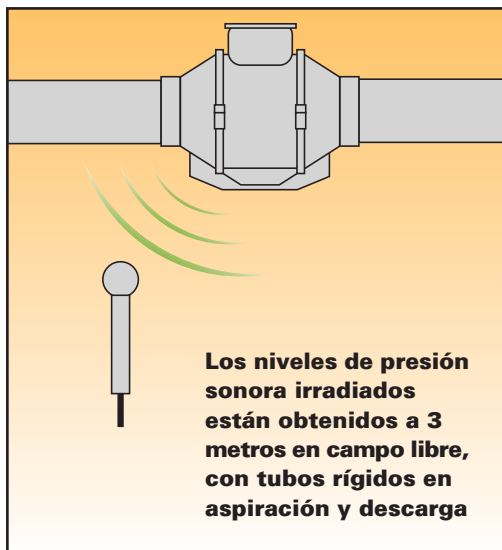
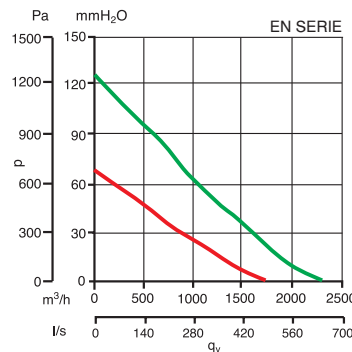
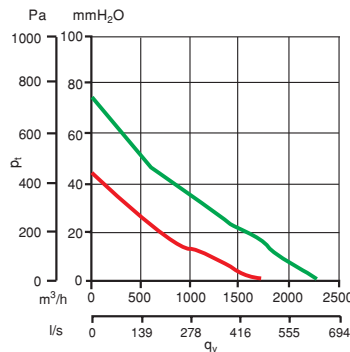

### Espectro de potencias acústicas en dB(A), en la aspiración del ventilador

Frecuencia Hz	125	250	500	1.000	2.000	4.000	8.000
LINEO 100 Q	27	46	51	54	52	44	33
LINEO 100	34	52	54	52	55	42	33
LINEO 125	33	51	55	58	61	48	40
LINEO 150	42	58	63	62	71	55	45
LINEO 160	41	58	62	63	71	58	48
LINEO 200	50	58	67	68	75	66	57
LINEO 250	51	63	73	74	77	63	54
LINEO 315	55	68	75	80	81	67	59

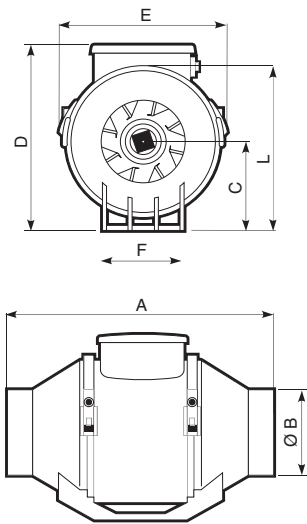

## Dimensiones

Modelo	A	ØB	C	D	E	F	L
Lineo 100 Q	231	96	82	174	156	95	152
Lineo 100	303	96	101,5	211	188,5	90	189
Lineo 125	258	122	101,5	211	188,5	90	189
Lineo 150	294	146	112,5	234	214,5	110	212
Lineo 160	272,5	156	112,5	234	214,5	110	212
Lineo 200	300	196	125,5	260,5	234,5	140	235
Lineo 250	385	247	152,5	317	300	176,5	292
Lineo 315	448	312	188,5	392,5	361,5	220,5	359

## Resumen de características

	Lineo 100 Q	Lineo 100	Lineo 125	Lineo 150	Lineo 160	Lineo 200	Lineo 250	Lineo 315
Envolvente en plástico Autoextinguible V0	●	●	●	●	●	●	●	●
Envolvente de alta resistencia mecánica	●	●	●	●	●	●	●	●
Turbina en plástico Autoextinguible V0	●	●	●	●	●	●	●	●
Cuerpo desmontable y orientable	●	●	●	●	●	●	●	●
Protección contra chorro de agua IP X4	●	●	●	●	●	●	●	●
Aislamiento del motor	●	●	●	●	●	●	●	●
Temporizador ajustable de 3 a 20 minutos	●	●	●	●	●	●		
Motores con dos velocidades	●	●	●	●	●	●	●	●
Protección contra sobrecargas eléctricas	●	●	●	●	●	●		
Protección contra sobrecargas con rearme manual							●	●
Rodamientos LONG LIFE 30.000 horas	●	●	●	●	●	●	●	●
Motores regulables (excepto en modelos "TIMER")	●	●	●	●	●	●	●	●

## Accesorios



	Kit de instalación en serie (tubo)	Placa de instalación en serie	Kit de instalación en paralelo (bridas y raíles)	Válvulas de mariposa	Rejillas fijas	Reguladores electrónicos de velocidad	Cajas de filtros de aire	Baterías eléctricas
Lineo 100 Q				●	●	●	●	●
Lineo 100	●	●	●	●	●	●	●	●
Lineo 125	●	●	●	●	●	●	●	●
Lineo 150	●	●	●	●	●	●	●	●
Lineo 160	●	●	●	●	●	●	●	●
Lineo 200	●	●	●	●	●	●	●	●
Lineo 250	●	●	●	●	●	●	●	●
Lineo 315	●	●		●	●	●	●	●

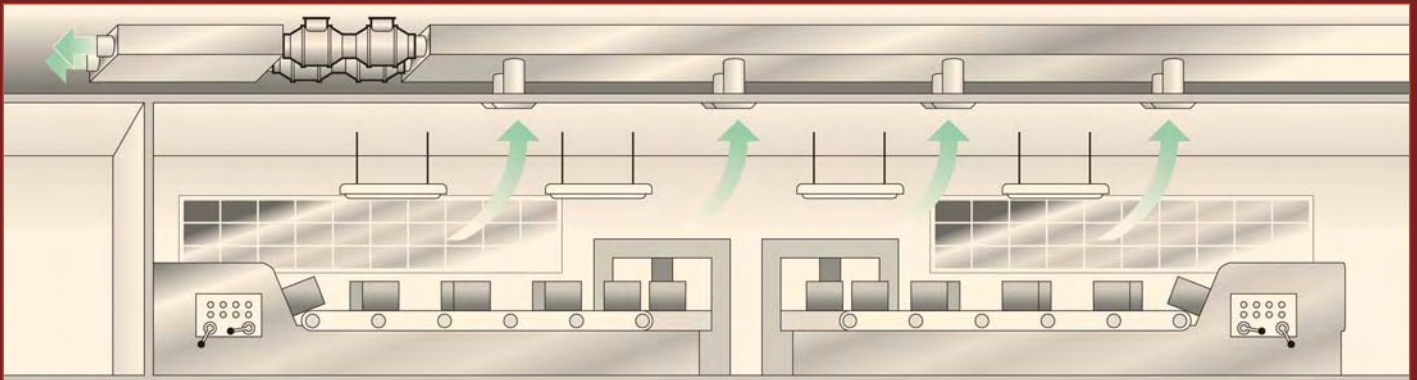
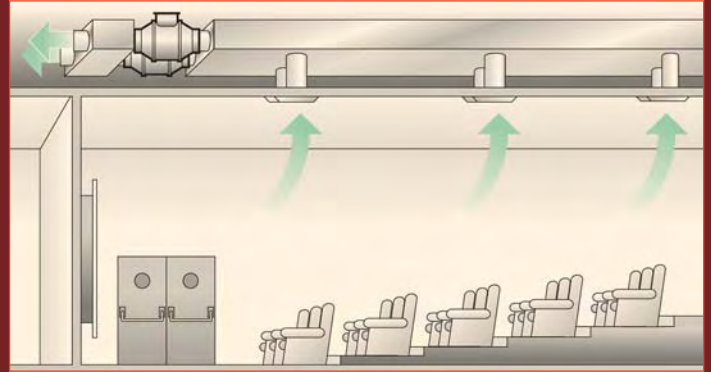
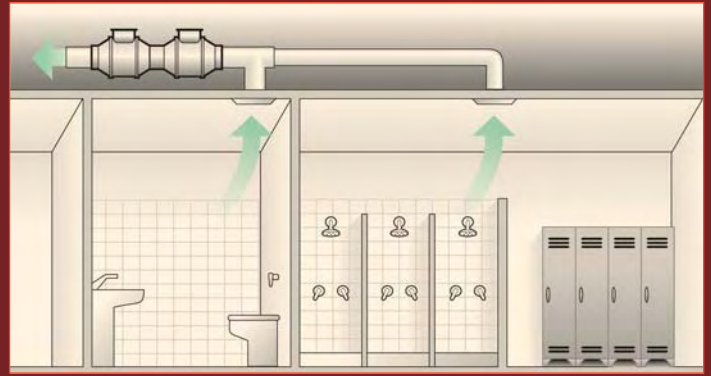
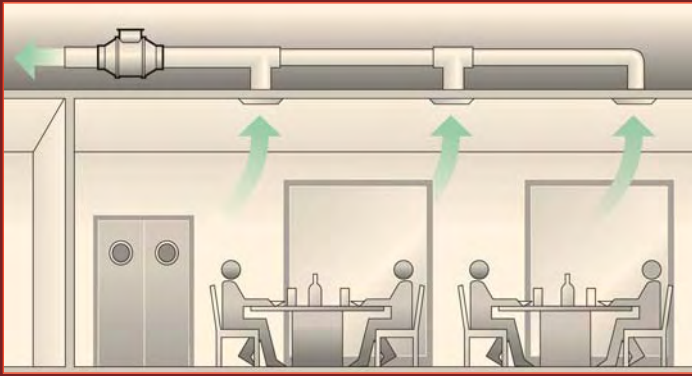

# LINEO

Ctra. de Berga, km 0,7  
08580 SANT QUIRZE DE BESORA  
(Barcelona - Spain)  
Tel. 93 852 91 11  
Fax 93 852 90 42  
comercial@sodeca.com  
[www.sodeca.com](http://www.sodeca.com)

