

Ventiladores helicoidales murales, con motor IP55



HC



HC 71,80,90,100

Ventiladores helicoidales murales, con hélice de plástico reforzada en fibra de vidrio

Ventilador:

- Marco soporte en chapa de acero
- Hélice en poliamida 6 reforzada con fibra de vidrio
- Rejilla de protección contra contactos según norma UNE 100250
- Modelos 71, 80, 90 y 100, la rejilla de protección se suministra como accesorio
- Dirección aire motor-hélice



Motores normalizados para facilitar recambios

Motor:

- Motores clase F, con rodamientos a bolas, protección IP55, excepto modelos monofásicos desde el tamaño 45 hasta el tamaño 63, protección IP54. De 1 ó 2 velocidades según modelo
- Monofásicos 230V.-50Hz., y trifásicos 230/400V.-50Hz.(hasta 5,5CV.) y 400/690V 50Hz.(potencias superiores a 5,5CV.)
- Temperatura de trabajo: -25°C.+ 60°C.

Acabado: Anticorrosivo en resina de poliéster polimerizada a 190°C, previo desengrase alcalino y pretratamiento libre de fosfatos.

Bajo demanda:

- Conjunto motor, hélice y rejilla (versión F)
- Grupo motor hélice, versión G.
- Dirección aire hélice-motor.
- Bobinados especiales para diferentes tensiones.

Características técnicas

Modelo	Velocidad (r/min)	Intensidad máxima admisible (A)			Potencia instalada (kW)	Caudal máximo (m3/h)	Nivel de presión sonora dB(A)	Peso Aprox. Kg.
		230V	400V	690V				
HC-25-2T/H	2760	0,83	0,48		0,12	2200	64	5
HC-25-2M/H	2760	1,10			0,12	2200	64	5
HC-25-4T/H	1450	0,60	0,35		0,10	1300	51	5
HC-25-4M/H	1450	0,63			0,10	1300	51	5
HC-31-2T/H	2780	1,38	0,80		0,18	3650	72	6
* HC-31-2M/H	2780	1,85			0,18	3650	72	6
HC-31-4T/H	1430	0,64	0,37		0,10	2400	54	6
HC-31-4M/H	1430	0,75			0,10	2400	54	6
HC-31-4T/L	1455	0,65	0,38		0,08	1800	52	6
HC-31-4M/L	1455	0,67			0,10	1800	52	6
HC-35-2T/H	2830	2,25	1,30		0,37	6020	76	8
HC-35-4T/H	1360	0,72	0,42		0,10	3500	58	7
HC-35-4M/H	1360	0,87			0,10	3500	58	7
HC-35-4T/L	1440	0,64	0,37		0,10	2600	56	7
HC-35-4M/L	1440	0,67			0,10	2600	56	7
HC-40-4T/H	1400	1,82	1,05		0,25	5200	63	10
HC-40-4M/H	1340	2,20			0,25	5200	63	10
HC-40-4T/L	1335	0,70	0,41		0,10	4000	59	8
HC-40-4M/L	1335	1,01			0,10	4000	59	8
HC-40-6T/H	970	1,30	0,75		0,25	3700	55	10
HC-40-6M/H	970	1,30			0,25	3700	55	10

* No regulable



Características técnicas

Modelo	Velocidad (r/min)	Intensidad máxima admisible (A)			Potencia instalada (kW)	Caudal máximo (m ³ /h)	Nivel de presión sonora dB(A)	Peso Aprox. Kg.
		230V	400V	690V				
HC-45-4T/H	1380	2,08	1,20		0,37	7300	66	14
HC-45-4M/H	1375	3,10			0,37	7300	66	14
HC-45-4T/L	1400	1,82	1,05		0,25	5600	63	11
HC-45-4M/L	1355	2,15			0,25	5600	63	11
HC-45-6T/H	950	1,47	0,85		0,25	5200	57	14
HC-45-6M/H	950	1,50			0,25	5200	57	14
HC-50-4T/H	1380	2,94	1,70		0,55	10200	69	18
HC-50-4M/H	1350	5,02			0,55	10200	69	18
HC-50-4T/L	1400	1,82	1,05		0,25	7400	66	12
HC-50-4M/L	1340	2,30			0,25	7400	66	12
HC-50-6T/H	960	2,08	1,20		0,37	6300	59	18
HC-50-6M/H	960	2,50			0,37	6300	59	18
HC-56-4T/H	1440	4,68	2,70		1,10	13000	72	24
HC-56-4/8T/H	1440/710		2,90/1,30		1,10/0,25	13000/6500	72/57	24
HC-56-4T/L	1380	2,85	1,65		0,55	11050	70	18
HC-56-4M/L	1380	4,60			0,55	11050	70	18
HC-56-6T/H	940	2,25	1,30		0,37	8400	61	19
HC-56-6M/H	940	2,50			0,37	8400	61	19
HC-63-4T/H	1415	5,20	3,00		1,10	16450	74	26
HC-63-4/8T/H	1440/710	-	3,15/1,30		1,10/0,25	16450/8225	74/59	26
HC-63-4T/L	1430	3,84	2,22		0,75	14400	73	19
HC-63-4M/L	1430	4,78			0,55	14400	73	19
HC-63-6T/H	890	2,42	1,40		0,37	12400	64	21
HC-63-6M/H	890	3,00			0,37	12400	64	21
HC-71-4T/H	1450	6,41	3,70		1,50	22300	78	35
HC-71-4/8T/H	1420/700	-	3,50/1,50		1,50/0,37	22300/11150	78/63	35
HC-71-6T/H	950	3,91	2,26		0,75	17500	66	36
HC-71-6/12T/H	935/435	-	2,20/0,87		0,75/0,15	17500/8750	66/51	35
HC-71-6M/H	950	4,10			0,75	15600	65	36
HC-80-4T/H	1450	11,78	6,80		3,00	33000	82	55
HC-80-4/8T/H	1430/710	-	6,50/2,30		3,00/0,60	33000/16500	82/67	53
HC-80-4T/L	1450	6,41	3,70		1,50	25000	79	44
HC-80-6T/H	950	4,16	2,40		0,75	22000	71	45
HC-80-6/12T/H	935/435	-	2,40/0,87		0,75/0,15	22000/11000	71/56	44
HC-80-6T/L	950	2,96	1,71		0,55	19200	70	39
HC-90-4T/H	1450	15,24	8,80		4,00	43500	86	68
HC-90-4/8T/H	1430/710	-	8,80/2,90		4,00/0,80	43500/19800	86/69	74
HC-90-4T/L	1450	11,78	6,80		3,00	33800	83	63
HC-90-6T/H	950	7,62	4,40		1,50	33300	76	60
HC-90-6/12T/H	970/470	-	4,60/1,90		1,50/0,25	33300/16650	76/61	70
HC-90-6T/L	950	5,00	2,89		1,10	26200	73	55
HC-90-8T/H	720	3,26	1,88		0,55	19800	69	54
HC-100-4T/H	1450	-	11,90	6,90	5,50	54000	88	85
HC-100-4/8T/H	1460/725	-	12,50/4,10		5,50/1,10	54000/27000	88/73	95
HC-100-4T/L	1450	15,24	8,80		4,00	42500	84	71
HC-100-6T/H	950	7,62	4,40		1,50	37000	78	63
HC-100-6/12T/H	970/470	-	4,60/1,90		1,50/0,25	37000/18500	78/63	73
HC-100-6T/L	950	5,00	2,89		1,10	28100	76	58
HC-100-8T/H	720	4,23	2,44		0,75	27000	72	61



Dimensiones mm

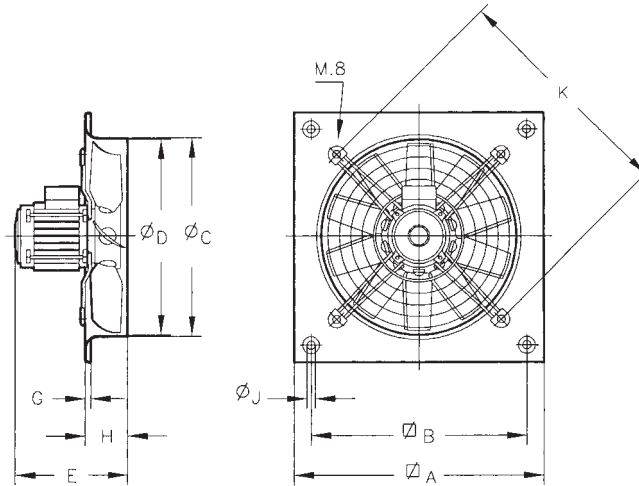

Modelo	ØA	ØB	ØC	ØD	E	G	H	ØJ	K
HC-25	330	275	262	260	237	11	56	8,5	310
HC-31	400	336	310,5	308	204	11	75	10,5	380
HC-35-2	465	390	362,5	360	245	11	86	10,5	450
HC-35-4	465	390	362,5	360	215	11	86	10,5	450
HC-40-4.../H	532	452	412,5	410	266	11	97,5	10,5	500
HC-40-4.../L	532	452	412,5	410	226	11	97,5	10,5	500
HC-40-6.../H	532	452	412,5	410	286	11	97,5	10,5	500
HC-45-4T/H	596	504	462,5	460	283	11	105	10,5	560
HC-45-4M/H	596	504	462,5	460	276	11	105	10,5	560
HC-45-4.../L	596	504	462,5	460	274	11	105	10,5	560
HC-45-6.../H	596	504	462,5	460	316	11	105	10,5	560
HC-50-4T/H	665	562	516,5	514	293	11	115	10,5	640
HC-50-4M/H	665	562	516,5	514	310	11	115	10,5	640
HC-50-4.../L	665	562	516,5	514	284	11	115	10,5	640
HC-50-6.../H	665	562	516,5	514	342	11	115	10,5	640
HC-56-4T/H	710	630	563	560	386	15	115	10,5	721
HC-56-4T/L	710	630	563	560	293	15	115	10,5	721
HC-56-4M/L	710	630	563	560	293	15	115	10,5	721
HC-56-6.../H	710	630	563	560	345	15	115	10,5	721
HC-63-4T/H	800	710	638	635	411	15	140	10,5	820
HC-63-4.../L	800	710	638	635	325	15	140	10,5	820
HC-63-6.../H	800	710	638	635	370	15	140	10,5	820
HC-71-4T/H	850	810	715	711	423	20	170	14,5	-
HC-71-6T/H	850	810	715	711	395	20	170	14,5	-
HC-71-4TMH	850	810	715	711	395	20	170	14,5	-
HC-80-4T/H	970	910	801	797	488	20	210	14,5	-
HC-80-4T/L	970	910	801	797	458	20	210	14,5	-
HC-80-6T/H	970	910	801	797	430	20	210	14,5	-
HC-80-6T/L	970	910	801	797	475	20	210	14,5	-
HC-90-4T/H	1170	1110	918	914	511	20	210	14,5	-
HC-90-4T/L	1170	1110	918	914	488	20	210	14,5	-
HC-90-6T/H	1170	1110	918	914	492	20	210	14,5	-
HC-90-6T/L	1170	1110	918	914	455	20	210	14,5	-
HC-90-8T/H	1170	1110	918	914	471	20	210	14,5	-
HC-100-4T/H	1170	1110	1003	999	548	20	220	14,5	-
HC-100-4T/L	1170	1110	1003	999	521	20	220	14,5	-
HC-100-6T/H	1170	1110	1003	999	502	20	220	14,5	-
HC-100-6T/L	1170	1110	1003	999	465	20	220	14,5	-
HC-100-8T/H	1170	1110	1003	999	508	20	220	14,5	-



Características acústicas

Los valores indicados, se determinan mediante medidas de nivel de presión y potencia sonora en dB(A) obtenidas en campo libre a una distancia equivalente a dos veces la envergadura del ventilador más el diámetro de la hélice, con un mínimo de 1,5 mts.

Espectro de potencia sonora Lw(A) en dB(A) por banda de frecuencia en Hz.

Modelo	63	125	250	500	1000	2000	4000	8000
25-2/H	38	48	65	65	73	69	62	53
25-4/H	25	35	52	52	60	56	49	40
31-2/H	46	56	73	73	81	77	70	61
31-4/H	28	38	55	55	63	59	52	43
31-4/L	26	36	53	53	61	57	50	41
35-2/H	50	60	77	77	85	81	74	65
35-4/H	32	42	59	59	67	63	56	47
35-4/L	30	40	57	57	65	61	54	45
40-4/H	28	45	57	65	70	70	66	59
40-4/L	29	45	55	59	66	66	62	55
40-6/H	20	37	49	57	62	62	58	51
45-4/H	33	50	63	70	75	76	71	64
45-4/L	36	51	61	66	72	73	69	62
45-6/H	24	41	54	61	66	67	62	55
50-4/H	36	53	66	73	78	79	74	67
50-4/L	39	54	64	69	75	76	72	65
50-6/H	26	43	56	63	68	69	64	57
56-4/H	39	56	69	76	81	82	77	70
56-6/H	28	45	58	65	70	71	66	59
56-8/H	24	41	54	61	66	67	62	55
56-4/L	43	58	68	73	79	80	76	69
63-4/H	43	60	73	80	85	86	81	74
63-6/H	33	50	63	70	75	76	71	64
63-8/H	28	45	58	65	70	71	66	59

Modelo	63	125	250	500	1000	2000	4000	8000
63-4/L	48	63	73	78	84	85	81	74
71-4/H	47	64	77	84	89	90	85	78
71-6T/H	35	52	65	72	77	78	73	66
71-6M/H	34	51	64	71	76	77	72	65
71-8/H	32	49	62	69	74	75	70	63
71-12/H	20	37	50	57	62	63	58	51
80-4/H	60	81	88	93	96	92	85	74
80-6/H	49	70	77	82	85	81	74	63
80-8/H	45	66	73	78	81	77	70	59
80-12/H	34	55	62	67	70	66	59	48
80-4/L	57	78	85	90	93	89	82	71
80-6/L	48	69	76	81	84	80	73	62
90-4/H	64	85	92	97	100	96	89	78
90-6/H	54	75	82	87	90	86	79	68
90-8/H	47	68	75	80	83	79	72	61
90-12/H	39	60	67	72	75	71	64	53
90-4/L	61	82	89	94	97	93	86	75
90-6/L	51	72	79	84	87	83	76	65
100-4/H	68	88	96	101	103	100	93	82
100-6/H	58	78	86	91	93	90	83	72
100-8/H	52	72	80	85	87	84	77	66
100-12/H	43	63	71	76	78	75	68	57
100-4/L	64	84	92	97	99	96	89	78
100-6/L	56	76	84	89	91	88	81	70

Curvas Características

Q = Caudal en m³/h y m³/s.

Pe = Presión estática en mm.c.a. y Pa.

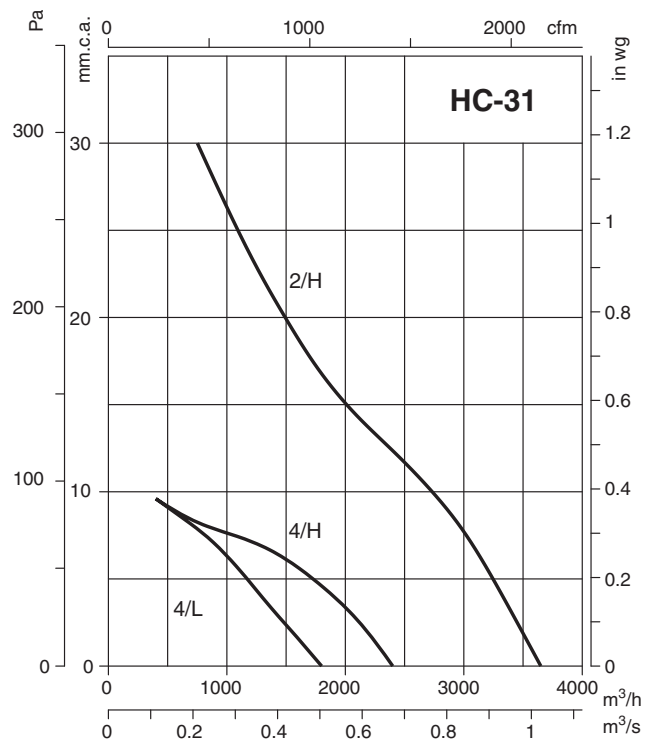
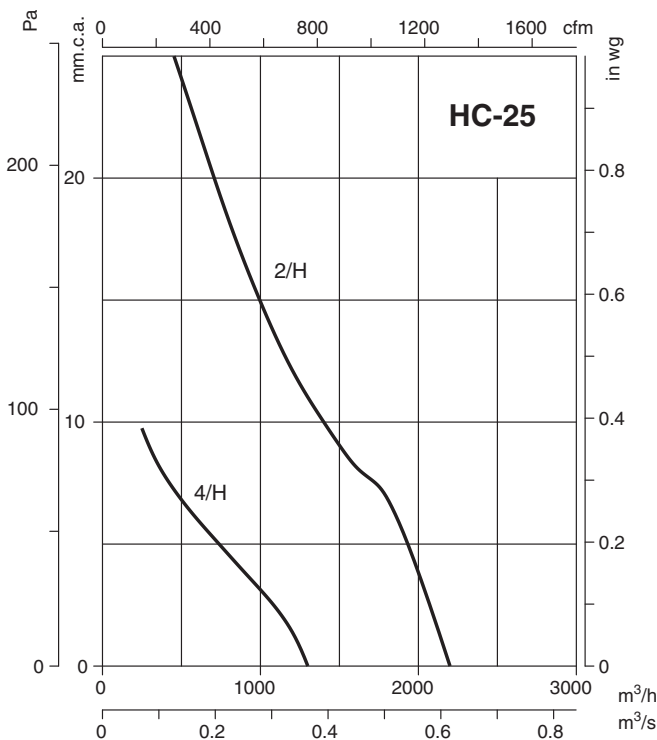



Curvas Características

Q = Caudal en m³/h y m³/s.

Pe = Presión estática en mm.c.a. y Pa.

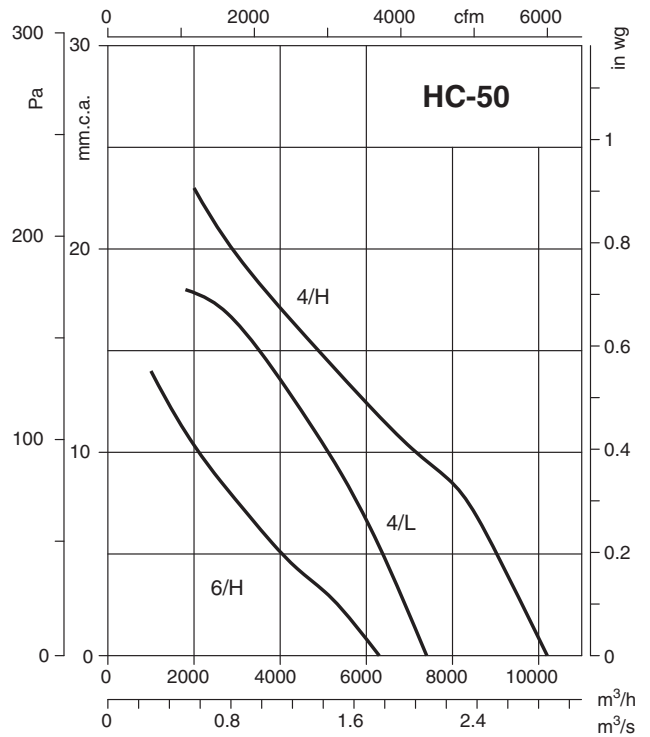
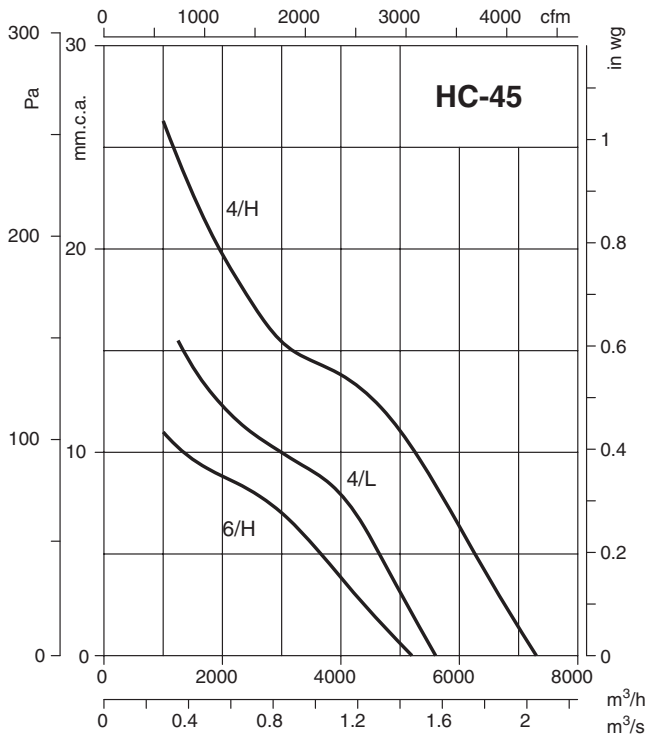
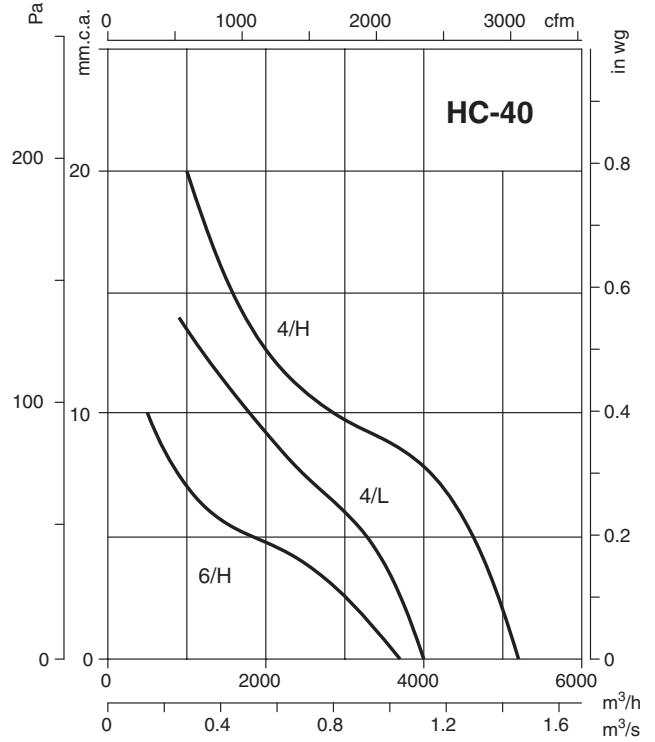
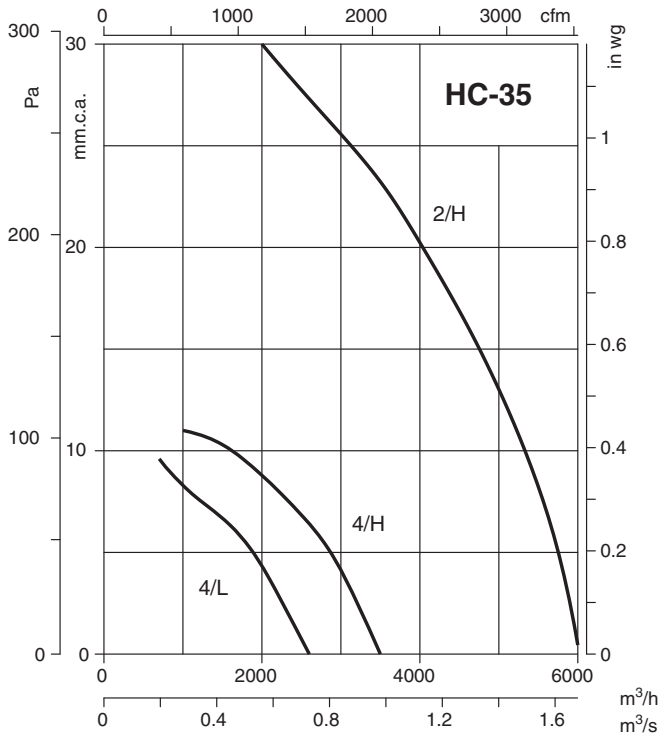



Curvas Características

Q = Caudal en m³/h y m³/s.

Pe = Presión estática en mm.c.a. y Pa.

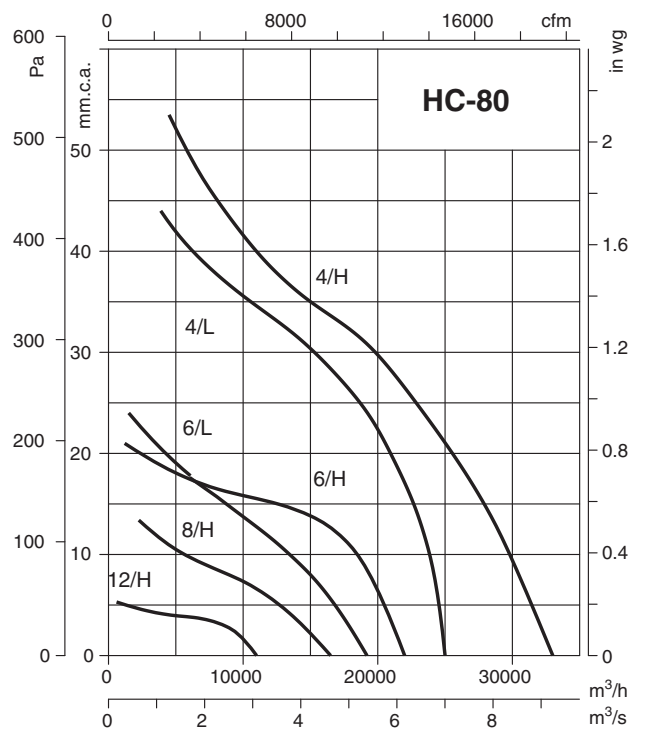
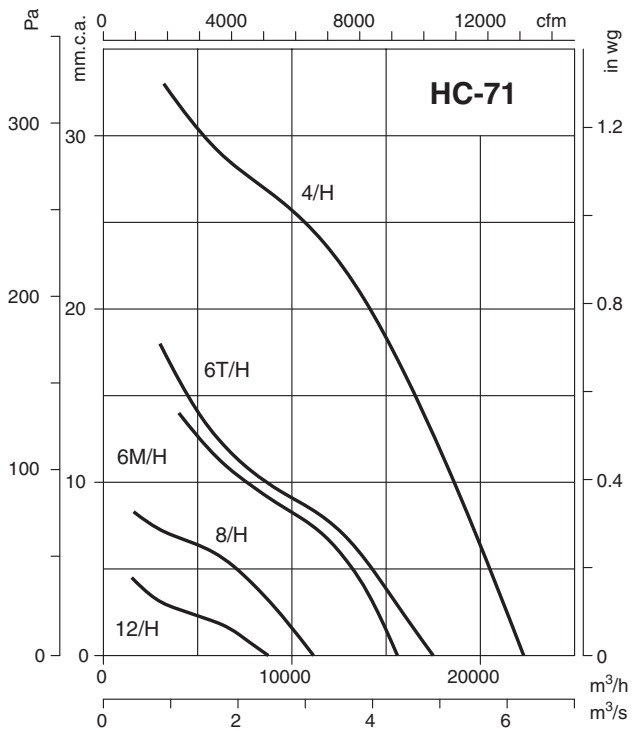
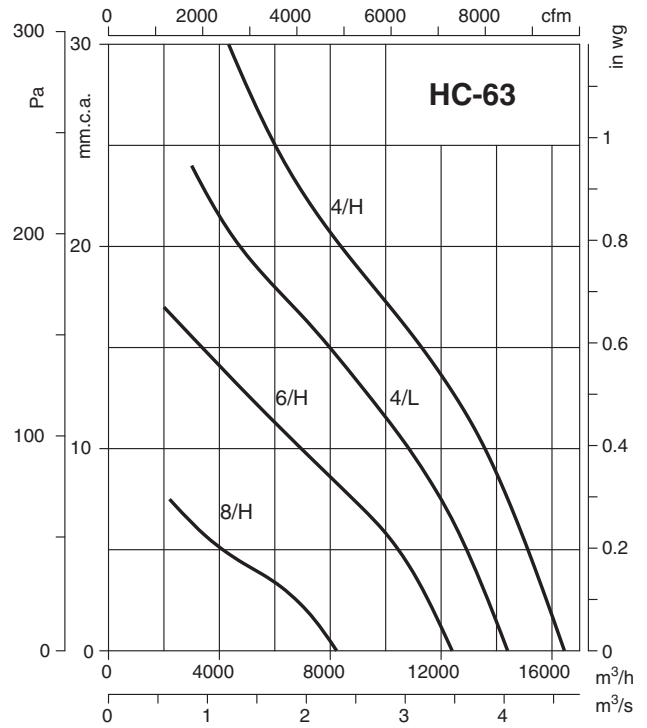
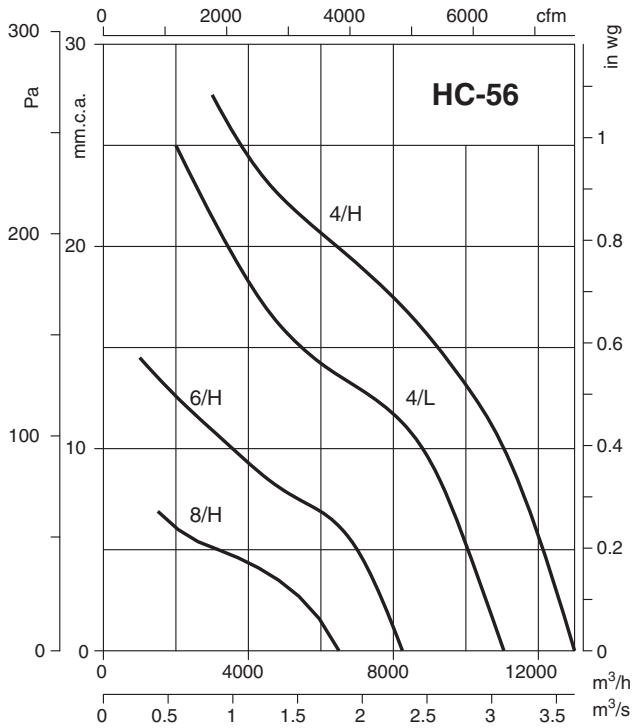



Curvas Características



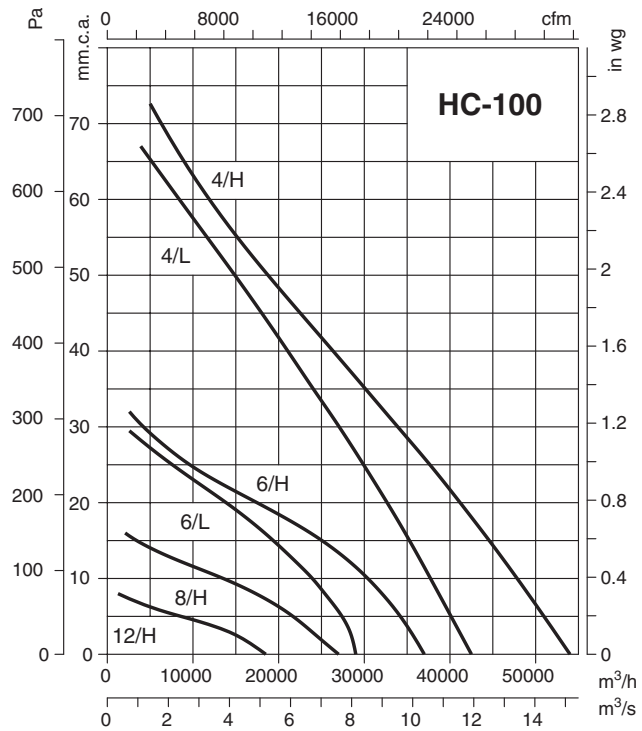
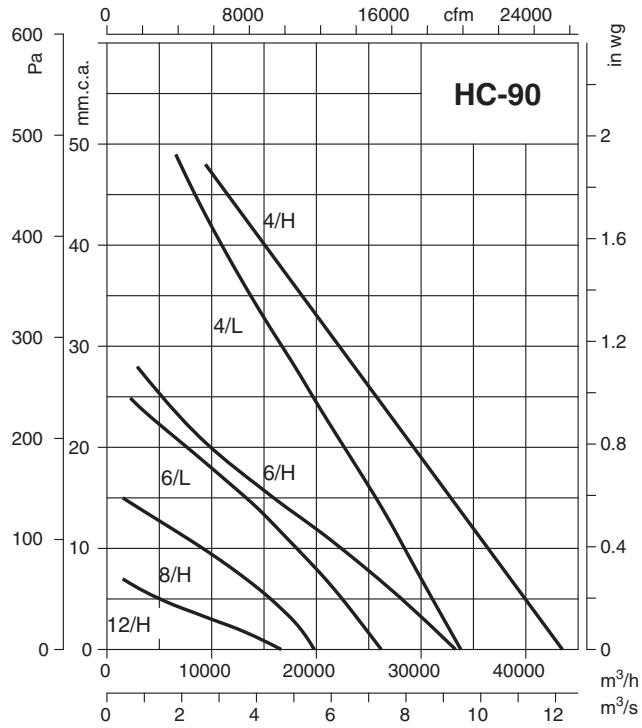

Q = Caudal en m³/h y m³/s.

Pe = Presión estática en mm.c.a. y Pa.



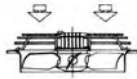
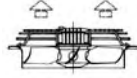

Código de Referencia

HC	25	2	T / H	I	E	
Helicoidal Mural	Diámetro hélice en cm	Número de polos motor	T=Trifásico M=Monofásico	Ángulo de inclinación de los álabes H= Alto L= Bajo	Sentido del aire I= Impelente Motor->Hélice A= Aspirante Hélice->Motor	Ejecucion del ventilador E= Ejecución estándar. F= Conjunto motor hélice rejilla. G= Grupo motor hélice.
		2= 2900 r./min. 50 Hz 4= 1400 r./min. 50 Hz 6= 900 r./min. 50 Hz 8= 750 r./min. 50 Hz 12= 500 r./min. 50 Hz			 	  

Accesorios

Ver apartado accesorios.

