



BLISTERS

\\ CATÁLOGO GENERAL \\ GRUPO10 \\ V.04-05 \\





ESTUCHES EXPOSITORES





Este catálogo 10 A es, por el momento, el último y el que acaba de documentar nuestra extensa gama de productos. Aquí encontrarán todos aquellos artículos para hacer fácil cualquier solución para un conexionado moderno y seguro. Este catálogo consta de tres partes: Estuches y cajas de servicio, expositores-mostradores diversos y blisters para los expositores. Cada una de estas partes de catálogo es muy amplia y muestra muchas y modernas piezas. Se han incorporado una gran cantidad de artículos de última generación a los modernos y atractivos packagings de los productos aquí presentados. Tanto los profesionales más exigentes como los aficionados al bricolaje encontrarán aquí las mejores soluciones amparadas por una altísima calidad. X.B. components, S.A. , siempre a su servicio.

For the moment, this catalogue 10 A will be our last catalogue and completes our documentation of our extensive range of products. Here you will find all the products you need to provide a practical solution for any modern, safe connection requirement. This catalogue consists of three parts: Service boxes, displays and display blisters. Each of the catalogue's parts provides a comprehensive listing of a large number of latest-generation products presented in attractive, modern packages. Both the most demanding professionals and DIY enthusiasts will find the best solutions here at unbeatable quality. X.B. components, S.A. always at your service.

Ce catalogue 10 A, le dernier à l'heure actuelle, termine la présentation de notre large gamme de produits. Vous y découvrirez tous les articles qui vous permettront de trouver une solution aisée pour une connexion moderne et sûre. Ce catalogue comprend trois parties: étuis et coffrets de service, présentoirs divers et blisters pour présentoirs. Chaque partie de ce catalogue est très étendue et offre un vaste choix de pièces modernes. Un nombre important d'articles de la dernière génération ont été ajoutés aux packagings modernes et séduisants des produits ici présentés. Les professionnels les plus exigeants, tout comme les amateurs de bricolage, y trouveront les meilleures solutions garanties par la plus grande qualité. X.B. components, S.A., toujours à votre service.

Aquest catàleg 10 A és, de moment, l'últim i el que acaba de documentar la nostra extensa gamma de productes. Aquí trobarán tots els articles per a fer fàcil qualsevol solució per a un connexionat modern i segur. Aquest catàleg consta de tres parts: Estoigs i caixes de servei, expositors-mostradors diversos i blisters per a els expositors. Cadascuna d'aquestes parts del catàleg és molt amplia i mostra moltes i modernes peces. S'han incorporat una gran quantitat d'articles d'última generació als moderns i atractius packagings dels productes aquí presentats. Tant els professionals més exigents com els aficionats al bricolatge trobarán aquí les millors solucions amparades per una altíssima qualitat. X.B. components, S.A., sempre al seu servei.



Estuches - Cajas de servicio10-7 a 10-17

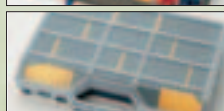

Estuches - Cajas de servicio vacías10-18 a 10-19

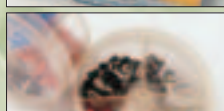

Cajas dosificadoras de punteras
aisladas y sin aislar10-20 a 10-23

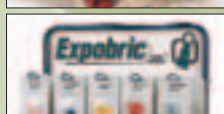

Expositores varios10-26 a 10-38



Expositores varios vacíos10-39 a 10-41



Kits de herramientas profesionales10-42 a 10-45



Botes y cajas de bridas y grapas surtidas10-48 a 10-55

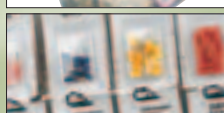

Blisters terminales, conectores, fusibles,
bridas y otros10-56 a 10-88



Bolsas para expositor de tubo termo-retráctil10-89

ESTUCHES EXPOSITORES



ESTUCHES

CAJAS DE SERVICIO

¿Sabía qué...

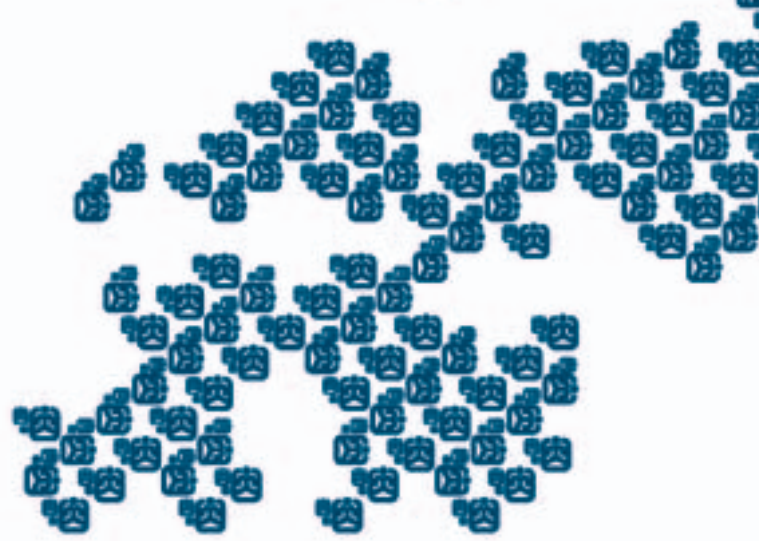

...X.B. components, s.a. cuenta con un centro de distribución de 3000 m² en Barcelona, así como con otro centro de distribución de 1500 m² en Madrid y una oficina comercial en París?

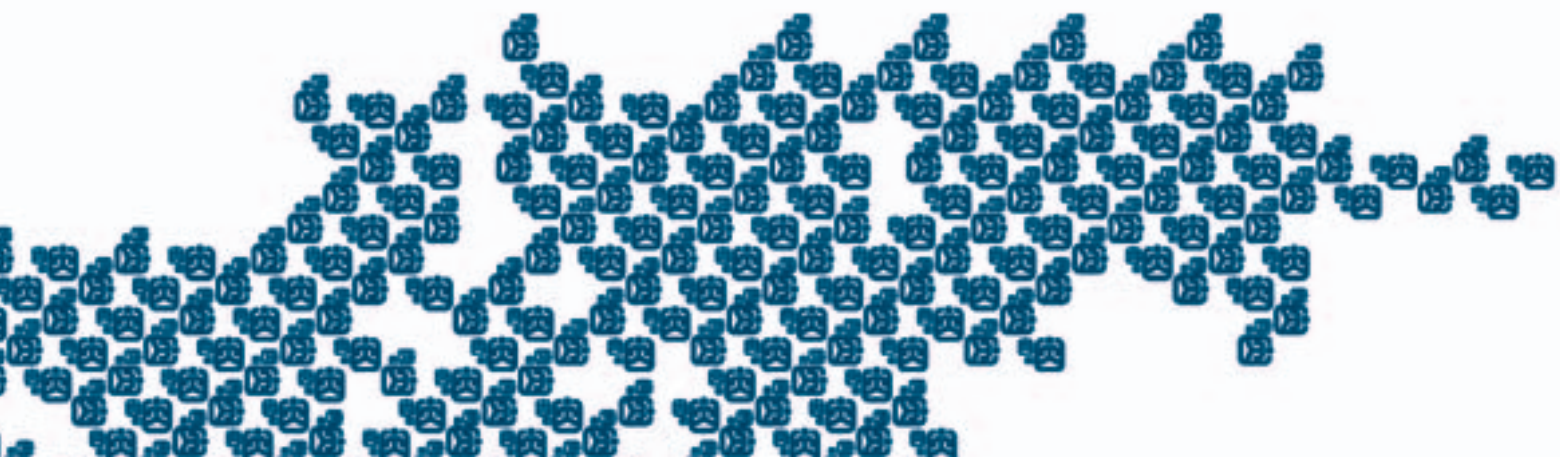



Estuches - Cajas de servicio



Ref. **CS-25-A**

Especial para ELECTRO-AUTO

- Dimensiones exteriores: 340 x 265 x 57 mm.
- Caja fabricada en PP de copolímero de alta calidad que no se oxida ni deforma con el tiempo. Con tapa transparente que permite ver su contenido y tres bisagras irrompibles. Con 24 compartimentos móviles para terminales y uno para la herramienta.
- Dos cierres deslizantes de alta seguridad y asa para transporte.
- Es reciclable al final de su vida útil.
- Contenido: 895 terminales aislados y 1 herramienta para los mismos.



Ref. **CS-25-D**

Especial para ELECTRO-AUTO

- Dimensiones exteriores: 340 x 265 x 57 mm.
- Caja fabricada en PP de copolímero de alta calidad que no se oxida ni deforma con el tiempo. Con tapa transparente que permite ver su contenido y tres bisagras irrompibles. Con 24 compartimentos móviles para terminales y uno para la herramienta.
- Dos cierres deslizantes de alta seguridad y asa para transporte.
- Es reciclable al final de su vida útil.
- Contenido: 1.675 terminales desnudos con garras, 150 protecciones y 1 herramienta para los mismos.

Ref.		Ref.	
PVCC-15063	50	PVC-15043	50
PVCC-15635	50	PVC-25043	50
PVCC-25063	50	PVC-55043	25
PVCC-25635	50	PVC-15053	50
PVCC-55063	25	PVC-25053	50
PVCC-55635	25	PVC-55053	25
PVCC-25048	50	PVC-15064	50
PVCC-25480	50	PVC-25064	50
PVCC-25079	50	PVC-55064	25
PVCC-55095	25	CR-100	10
PVCC-25635-1	25	CR-250	10
PVCC-25039	25	MEB-100	1
PVCC-25040-1	25		

1/10

Ref.		Ref.	
14408-00	100	25022-00	100
14416-00	100	25294-00	50
16413-00	100	17502-00	50
14648-00	100	13372-00	100
16422-00	100	13374-00	100
14478-00	25	13378-00	100
14370-00	100	13310-00	50
16466-00	100	18804-00	25
14327-00	75	17704-00	25
16432-00	75	PH-1000	100
15222-00	50	PH-1020	50
3838-6-00	50	MEB-300	1
18500-00	100		

1/10



Estuches - Cajas de servicio



Ref. **CS-25-AMIXT**

Especial para ELECTRO-AUTO

- Dimensiones exteriores: 340 x 265 x 57 mm.
- Caja fabricada en PP de copolímero de alta calidad que no se oxida ni deforma con el tiempo. Con tapa transparente que permite ver su contenido y tres bisagras irrompibles. Con 32 compartimentos móviles para terminales.
- Dos cierres deslizantes de alta seguridad y asa para transporte.
- Es reciclable al final de su vida útil.
- Contenido: 925 terminales desnudos, con garras, 700 terminales pre-aislados, 20 conectores rápidos y 125 protecciones para terminales desnudos.

Ref.		Ref.	
14408-00	100	CR-250	10
14412-00	100	PVC-15028	50
14648-00	100	PVC-15048	50
16422-00	100	PVC-15063	50
14327-00	100	PVC-25063	50
16432-00	100	PVC-55063	25
13372-00	100	PVC-25063-2	25
13374-00	100	PVC-15635	50
13378-00	100	PVC-25635	50
15222-00	25	PVC-25039	50
PH-1020	25	PVC-25040-1	50
PH-1021	25	PVC-25043	50
CS-63N004-02	25	PVC-25053	50
PH-1000	25	PVC-25064	50
PH-1010	25	PVC-25084	50
CR-100	10	PVC-25023	50

1/10



Ref. **CS-25-I-COMBI**

Especial para ELECTRO-INDUSTRIA

- Dimensiones exteriores: 340 x 265 x 57 mm.
- Caja fabricada en PP de copolímero de alta calidad que no se oxida ni deforma con el tiempo. Con tapa transparente que permite ver su contenido y tres bisagras irrompibles. Con 24 compartimentos móviles para terminales y uno para la herramienta.
- Dos cierres deslizantes de alta seguridad y asa para transporte.
- Es reciclable al final de su vida útil.
- Contenido: 775 terminales aislados, 500 punteras y 2 herramientas para los mismos.

Ref.		Ref.	
PVC-15043	50	PVC-25023	50
PVC-25043	50	PVC-55034	25
PVC-55043	25	PVC-15019-12	50
PVC-15053	50	PVC-25019-12	50
PVC-25053	50	PVC-55027	25
PVC-55053	25	NCE-2-1	25
PVC-15043-A	50	TE-0,75	100
PVC-25043-A	50	TE-1,00	100
PVC-55043-A	25	TE-1,50	100
PVC-15053-A	50	TE-2,50	100
PVC-25053-A	50	TE-4,00	100
PVC-55053-A	25	MEB-100	1
PVC-15017	50	XB-9083	1

1/10



Estuches - Cajas de servicio



Ref. **CS-PUNT**

Especial para ELECTRO-INDUSTRIA

- Dimensiones exteriores: 375 x 280 x 60 mm.
- Contenido: 4.650 punteras aisladas, 200 bridas y 1 herramienta profesional para punteras.



Ref. **CS-PUNT-D**

Especial para ELECTRO-INDUSTRIA

- Dimensiones exteriores: 340 x 265 x 57 mm.
- Caja fabricada en PP de copolímero de alta calidad que no se oxida ni deforma con el tiempo. Con tapa transparente que permite ver su contenido y tres bisagras irrompibles. Con 26 compartimentos móviles para punteras y uno para la herramienta.
- Dos cierres deslizantes de alta seguridad y asa para transporte.
- Es reciclable al final de su vida útil.
- Contenido: 18.950 punteras huecas sin aislar y 1 herramienta profesional para las mismas.

Ref.		Ref.	
TE-0,50	500	DUO-2X1.00	200
TE-0,75	500	DUO-2X1.50	200
TE-1,00	500	DUO-2X2.50	100
TE-1,00	500	DUO-2X4.00	100
TE-1,50	500	DUO-2X6.00	50
TE-2,50	300	TE-1508-XL	100
TE-4,00	200	TE-2508-XL	100
TE-6,00	100	TE-4010-XL	100
DUO-2X0.50	200	CV-140	100
DUO-2X0.75	200	CV-100	100
DUO-2X1.00	200	SN-06-WF	1

1/10

Ref.		Ref.	
P-0.34-5	1.000	P-1.50-10	500
P-0.50-6	1.000	P-1.50-12	500
P-0.50-8	1.000	P-2.50-6	1.000
P-0.50-10	1.000	P-2.50-8	500
P-0.75-6	1.000	P-2.50-10	500
P-0.75-6	1.000	P-2.50-12	500
P-0.75-8	1.000	P-4.00-8	500
P-0.75-10	1.000	P-4.00-12	250
P-1.00-6	1.000	P-6.00-10	250
P-1.00-6	1.000	P-6.00-12	200
P-1.00-8	1.000	P-10.00-12	150
P-1.00-10	1.000	P-16.00-12	100
P-1.50-6	1.000	XB-1904	1
P-1.50-8	1.000		

1/10



Estuches - Cajas de servicio



Ref. **CS-INYEC**

Especial para ELECTRO-AUTO

- Dimensiones exteriores: 310 x 245 x 52 mm.
- Contenido: 31 conectores y 200 terminales especiales para inyección electrónica.



Ref. **CS-INYEC-T**

Especial para ELECTRO-AUTO

- Dimensiones exteriores: 240 x 180 x 40 mm.
- Contenido: 500 terminales de nueva generación para inyección electrónica.

Ref.		Ref.	
44.20900	5	44.20901	2
44.20910	5	44.20902	2
44.20920	3	44.20911	2
44.10655	2	44.20921	2
44.10656	2	44.20931	2
44.10657	2	18400-01	100
44.20930	2	46353-32	100

1/10

Ref.		Ref.	
46121-52	25	11.04500-32	25
46127-52	25	46852-02	25
11.05560-32	25	46260-52	25
11.05550-32	25	18400-01	50
45704-02	25	19301-31	50
45523-02	25	12.01160-02	25
11.07970-32	25	12.01150-02	25
11.07960-32	25	46011-02	25
11.04510-32	25	46013-02	25

1/10



Estuches - Cajas de servicio



Ref. **CS-BAT**

Especial para ELECTRO-AUTO

- Dimensiones exteriores:
460 x 360 x 80 mm.
- Contenido:
44 terminales de batería surtidos y 12 trenzas masa.
- Referencias XB-1120 y XB-2120 especiales para:
CITROEN (Saxo, Xsara)
PEUGEOT (106)
RENAULT (Trafic, Laguna, Mégane, Space).

Ref.



XB-1120 (+)
XB-2120 (-)
TR-3520 (+)
TR-3521 (-)
TR-3540 (+)
TR-3541 (-)

4
4
4
4
4
4

Ref.



XB-1113 (+)
XB-2113 (-)
XB-1111 (+)
XB-2111 (-)
CMF-250-52
CMF-300-52

4
4
6
6
6
6

Estuches - Cajas de servicio



Ref. **CS-SEAL**

Especial para ELECTRO-AUTO

- Dimensiones: 240 x 180 x 40 mm.
- Contenido: 38 conectores, 100 terminales y 100 gomas estanqueidad "Gominos" de nueva generación para inyección electrónica.



Ref. **CS-LOK**

Especial para ELECTRO-AUTO

- Dimensiones: 310 x 245 x 52 mm.
- Contenido: 58 conectores UP-LOK, 200 terminales y 200 bridas sujetacables.

Ref.	Descripción	
44.23610	Conector SEAL 1 vías hembra	4
44.23620	Conector SEAL 1 vías macho	4
44.23630	Conector SEAL 2 vías hembra	4
44.23640	Conector SEAL 2 vías macho	4
44.23650	Conector SEAL 3 vías hembra	3
44.23660	Conector SEAL 3 vías macho	3
44.23670	Conector SEAL 4 vías hembra	4
44.23680	Conector SEAL 4 vías macho	4
44.23690	Conector SEAL 5 vías hembra	2
44.23700	Conector SEAL 5 vías macho	2
44.23710	Conector SEAL 6 vías hembra	2
44.23720	Conector SEAL 6 vías macho	2
11.05550-32	Terminal SEAL macho	50
44.07530	Goma estanqueidad amarilla	50
11.05560-32	Terminal SEAL hembra	50
44.07740	Goma estanqueidad roja	50

 1/10

Ref.	Descripción	
CS-02-M	Conector CS-LOK 2 vías macho	5
CS-02-F	Conector CS-LOK 2 vías hembra	5
CS-03-M	Conector CS-LOK 3 vías macho	5
CS-03-F	Conector CS-LOK 3 vías hembra	5
CS-04-M	Conector CS-LOK 4 vías macho	4
CS-04-F	Conector CS-LOK 4 vías hembra	4
CS-05-M	Conector CS-LOK 5 vías macho	3
CS-05-F	Conector CS-LOK 5 vías hembra	3
CS-06-M	Conector CS-LOK 6 vías macho	5
CS-06-F	Conector CS-LOK 6 vías hembra	5
CS-09-M	Conector CS-LOK 9 vías macho	4
CS-09-F	Conector CS-LOK 9 vías hembra	4
CS-12-M	Conector CS-LOK 12 vías macho	2
CS-12-F	Conector CS-LOK 12 vías hembra	2
CS-15-M	Conector CS-LOK 15 vías macho	1
CS-15-F	Conector CS-LOK 15 vías hembra	1
17522-01	Terminal macho sec. 0,5 - 2,5	100
18522-01	Terminal hembra sec. 0,5 - 2,5	100
CV-100-2	Brida sujetacables 100 x 2,5 amarillo	100
CV-100-8	Brida sujetacables 100 x 2,5 verde	100

 1/10



Estuches - Cajas de servicio



Ref. **CS-TR**

Especial para ELECTRO-AUTO y ELECTRO-INDUSTRIA



- Dimensiones exteriores: 240 x 180 x 40 mm.
- Contenido: 180 conectores estancos, terminales con aislante termo-contraíble y empalmes soldadura con adhesivo interno.





Ref. **CS-FU**

Especial para ELECTRO-AUTO

- Dimensiones exteriores: 310 x 245 x 52 mm.
- Contenido: 190 fusibles y porta-fusibles MINI, MAXI y JASO (De nueva generación para automóvil).

Ref.		Ref.	
SB-15043	10	SBC-15635	10
SB-25053	10	SBC-25635	10
SB-25064	10	SBC-25039	10
SB-55084	10	SB-1816	10
SB-55105	10	SB-1614	10
SBC-25040-1	10	SB-1210	10
SBC-15063-2	10	SBS-1	10
SBC-25063-2	10	SBS-2	10
SBC-55063-2	10	SBS-5	10

 1/10

Ref.		Ref.	
03.45.075-0	25	03.138-0	2
03.45.10-0	25	03.07660-0	4
03.45.15-0	25	03.26.0200-1	25
03.45.20-0	25	03.70.30-0	2
03.45.25-0	25	03.70.50-0	2
03.111-0	2	03.70.80-0	2
03.50.30-0	5	03.71.30-0	2
03.50.50-0	5	03.71.50-0	2
03.50.70-0	5	03.71.80-0	2
03.50.100-0	5		

 1/10



Estuches - Cajas de servicio



Ref. **CS-FU-2**

Especial para ELECTRO-AUTO

- Dimensiones exteriores: 240 x 180 x 40 mm.
- Contenido: 450 fusibles "clásicos" para automóvil.

Ref.		Ref.	
03.40.05-0	25	03.30.16-0	25
03.40.075-0	25	03.30.25-0	25
03.40.10-0	25	26-2	25
03.40.15-0	25	03.45.075-0	25
03.40.20-0	25	03.45.10-0	25
03.40.25-0	25	03.45.15-0	25
03.40.30-0	25	03.45.20-0	25
03.30.05-0	25	03.45.25-0	25
03.30.08-0	25	03.45.30-0	25

1/10

FUSIBLES CON INDICADOR LUMINOSO DE FUSIÓN -LED-



Ref. **CS-FU-LED**

Especial para ELECTRO-AUTO

- Dimensiones exteriores: 240 x 180 x 40 mm.
- Contenido: **66 FUSIBLES-LED-LUMINOSOS** de las series MINI y UNIVERSAL para automóvil.

Ref. SERIE MINI		Ref. SERIE UNIVERSAL	
03.45L.03-0	3	03.40L.03-0	3
03.45L.04-0	3	03.40L.04-0	3
03.45L.05-0	3	03.40L.05-0	3
03.45L.075-0	3	03.40L.075-0	3
03.45L.10-0	5	03.40L.10-0	5
03.45L.15-0	5	03.40L.15-0	5
03.45L.20-0	5	03.40L.20-0	5
03.45L.25-0	3	03.40L.25-0	3
03.45L.30-0	3	03.40L.30-0	3

1/10



Estuches - Cajas de servicio



Ref. **CS-FU-3**

Especial para ELECTRO-INDUSTRIA HOMOLOGADOS

- Dimensiones exteriores: 240 x 180 x 40 mm.
- Contenido: 675 fusibles de cristal HOMOLOGADOS.
- Para industria eléctrica y electrónica.

Ref.
5 x 20 mm.



Ref.
6,3 x 32 mm.



03.26.500-1	50
03.26.0100-1	50
03.26.0200-1	50
03.26.0300-1	50
03.26.0400-1	50
03.26.0500-1	50
03.26.0600-1	50
03.26.0800-1	50
03.26.1000-1	50

03.35.500-1	25
03.35.0100-1	25
03.35.0200-1	25
03.35.0300-1	25
03.35.0400-1	25
03.35.0500-1	25
03.35.0600-1	25
03.35.0800-1	25
03.35.1000-1	25

1/10

HOMOLOGACIONES:



Ref. **CS-FU-3E**

Especial para ELECTRO-INDUSTRIA ECONÓMICOS

- Dimensiones exteriores: 240 x 180 x 40 mm.
- Contenido: 675 fusibles de cristal para industria eléctrica y electrónica.

Ref.
5 X 20 ECONÓMICOS



Ref.
6,3 x 32 mm.



26-500 mA	50
26-1 A	50
26-2 A	50
26-3 A	50
26-4 A	50
26-5 A	50
26-6 A	50
26-8 A	50
26-10 A	50

35-500 mA	25
35-1 A	25
35-2 A	25
35-3 A	25
35-4 A	25
35-5 A	25
35-6 A	25
35-8 A	25
35-10 A	25

1/10



Estuches - Cajas de servicio



Ref. **CS-BR**

Especial para **ELECTRO-AUTO**

- Dimensiones exteriores: 460 x 360 x 80 mm.
- Contenido: 2.300 bridas sujetacables color negro de 100 a 368 mm.
Para el sector automoción.



Ref. **CS-BR-NAT**

Especial para **ELECTRO-INDUSTRIA**

- Dimensiones exteriores: 460 x 360 x 80 mm.
- Contenido: 2.300 bridas sujetacables color natural de 100 a 368 mm.
Para el sector electro-industrial.

Ref.	Dimensiones	
CV-100B	100 x 2,5 mm.	600 Bridas
CV-140SB	142 x 2,5 mm.	400 Bridas
CV-200MB	203 x 2,5 mm.	400 Bridas
CV-150B	150 x 3,7 mm.	300 Bridas
CV-200B	203 x 4,6 mm.	200 Bridas
CV-250B	250 x 5,0 mm.	200 Bridas
CV-368B	368 x 5,0 mm.	200 Bridas

 1/10

Ref.	Dimensiones	
CV-100	100 x 2,5 mm.	600 Bridas
CV-140S	142 x 2,5 mm.	400 Bridas
CV-200M	203 x 2,5 mm.	400 Bridas
CV-150	150 x 3,7 mm.	300 Bridas
CV-200	203 x 4,6 mm.	200 Bridas
CV-250	250 x 5,0 mm.	200 Bridas
CV-368	368 x 5,0 mm.	200 Bridas

 1/10















Estuches - Cajas de servicio



Ref. **CS-BR-BRIC**

MULTIUSOS

- Dimensiones exteriores: 460 x 360 x 80 mm.
- Contenido: 1.800 bridas sujetacables de 100 a 280 mm. en colores surtidos.

Ref.	Color	Dimensiones	
 CV-100-2	amarillo	100 x 2,5 mm.	100 Bidas
 CV-100-3	azul	100 x 2,5 mm.	100 Bidas
 CV-100-6	rojo	100 x 2,5 mm.	100 Bidas
 CV-100-8	verde	100 x 2,5 mm.	100 Bidas
 CV-100-9	azul	100 x 2,5 mm.	100 Bidas
 CV-140S-8	verde	142 x 2,5 mm.	300 Bidas
 CV-200S-2	amarillo	200 x 2,5 mm.	200 Bidas
 CV-200S-3	azul	200 x 2,5 mm.	200 Bidas
 CV-200S-6	rojo	200 x 2,5 mm.	200 Bidas
 CV-200S-8	verde	200 x 2,5 mm.	200 Bidas
 CV-280-2	amarillo	280 x 5,0 mm.	100 Bidas
 CV-280-8	verde	280 x 5,0 mm.	100 Bidas

























 1/10



Ref. **CS-EP-400**

MULTIUSOS

- Dimensiones exteriores: 205 x 200 x 40 mm.
- Contenido: 400 bridas sujetacables de 100 a 200 mm. en colores surtidos "TIPO NEON".

Ref.	Color	Dimensiones	
  CV-100	Rosa / neón	100 x 2,5 mm.	50 bridas
  CV-100	Naranja / neón	100 x 2,5 mm.	50 bridas
  CV-100	Verde / neón	100 x 2,5 mm.	50 bridas
  CV-100	Amarillo / neón	100 x 2,5 mm.	50 bridas
  CV-150	Rosa / neón	150 x 3,7 mm.	25 bridas
  CV-150	Naranja / neón	150 x 3,7 mm.	25 bridas
  CV-150	Verde / neón	150 x 3,7 mm.	25 bridas
  CV-150	Amarillo / neón	150 x 3,7 mm.	25 bridas
  CV-200S	Rosa / neón	200 x 2,5 mm.	25 bridas
  CV-200S	Naranja / neón	200 x 2,5 mm.	25 bridas
  CV-200S	Verde / neón	200 x 2,5 mm.	25 bridas
  CV-200S	Amarillo / neón	200 x 2,5 mm.	25 bridas

 1/10



Estuches - Cajas de servicio / Cajas de servicio vacías



Ref. **CS-FM-1**

Especial para ELECTRO-INDUSTRIA

- Dimensiones exteriores: 470 x 130 x 125mm.
- Contenido: 6.500 marcadores.
- Tipo FM-1 del 0 al 9, +, - y / con fondo de color.
- (Código internacional)
- 500 unidades de cada referencia.



Ref. **CS-PUNT-V**

MULTIUSOS

- Dimensiones: 375 x 280 x 60 mm.



Ref. **CS-25-V**

MULTIUSOS

- Dimensiones: 335 x 250 x 55 mm.





Estuches - Cajas de servicio vacías



Ref. **CS-BR-V**

MULTIUSOS

- Dimensiones: 460 x 360 x 80 mm.

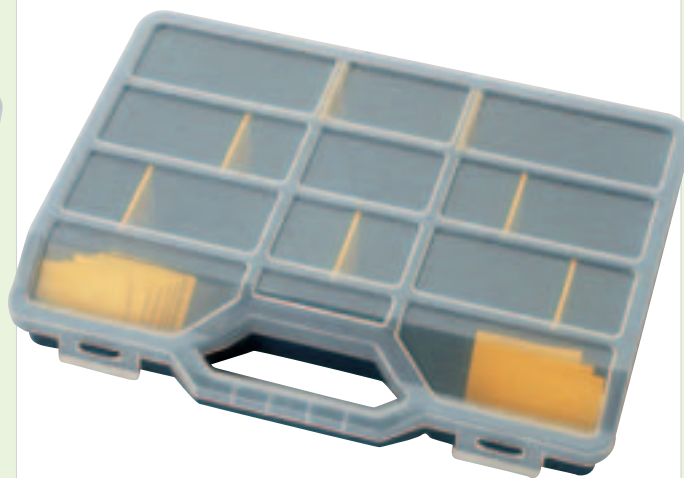

Ref. **CS-FU-V**

MULTIUSOS

- Dimensiones: 310 x 245 x 52 mm.

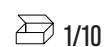

Ref. **CS-FU-2-V**

MULTIUSOS

- Dimensiones: 240 x 180 x 40 mm.



Ref. **CS-FM-1-V**

MULTIUSOS

- Dimensiones: 470 x 130 x 125 mm.





Cajas surtidas dosificadoras de punteras aisladas



Ref. **ESD-111**

1/10

Caja dosificadora con 400 punteras según detalle:

Ref. y sección		Largo mm.	Ref. y sección		Largo mm.
PD-0.50	50	8	PD-1.50	100	8
PD-0.75	100	8	PD-2.50	50	8
PD-1.00	100	8			



Ref. **ESD-1**

1/10

Caja dosificadora con 400 punteras según detalle:

Ref. y sección		Largo mm.	Ref. y sección		Largo mm.
TE-0.50	50	8	TE-1.50	100	8
TE-0.75	100	8	TE-2.50	50	8
TE-1.00	100	8			



Ref. **ESD-222**

1/10

Caja dosificadora con 100 punteras según detalle:

Ref. y sección		Largo mm.	Ref. y sección		Largo mm.
PD-4.00	50	10	PD-10.00	20	12
PD-6.00	20	12	PD-16.00	10	12



Ref. **ESD-2**

1/10

Caja dosificadora con 100 punteras según detalle:

Ref. y sección		Largo mm.	Ref. y sección		Largo mm.
TE-4.00	50	10	TE-10.00	20	12
TE-6.00	20	12	TE-16.00	10	12



Cajas surtidas dosificadoras de punteras aisladas

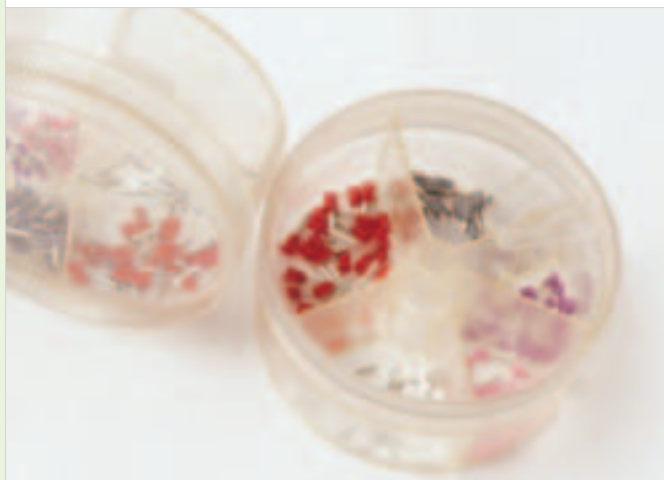

Ref. **ESD-999**

Caja dosificadora con 150 punteras según detalle:

Ref. y sección		Largo mm.	Ref. y sección		Largo mm.
PD-0.25	30	6	PD-0.75	30	8
PD-0.34	30	6	PD-1.00	30	8
PD-0.50	30	8			



Ref. **ESD-9**

Caja dosificadora con 150 punteras según detalle:

Ref. y sección		Largo mm.	Ref. y sección		Largo mm.
TE-0.25	30	6	TE-0.75	30	8
TE-0.34	30	6	TE-1.00	30	8
TE-0.50	30	8			

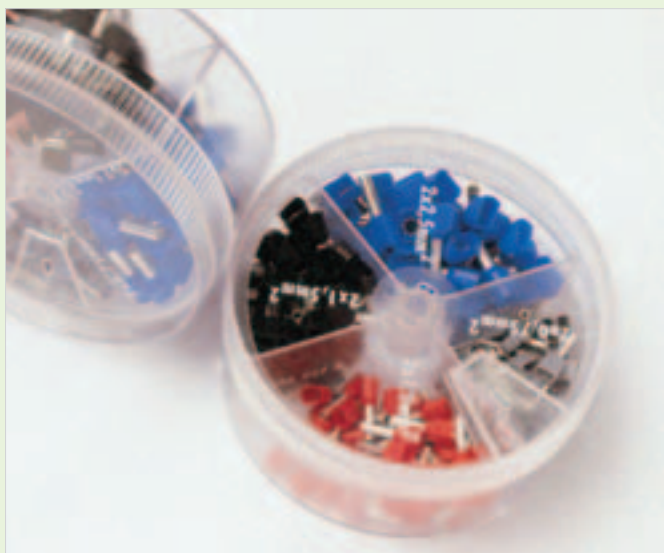

Ref. **ESD-555**

Caja dosificadora con 200 punteras DUO según detalle:

Ref. y sección		Largo mm.	Ref. y sección		Largo mm.
DUO-2 x 0.75	50	8	DUO-2 x 1.50	50	8
DUO-2 x 1.00	50	8	DUO-2 x 2.50	50	10



Ref. **ESD-5**

Caja dosificadora con 200 punteras TUO según detalle:

Ref. y sección		Largo mm.	Ref. y sección		Largo mm.
TUO-2 x 0.75	50	8	TUO-2 x 1.50	50	8
TUO-2 x 1.00	50	8	TUO-2 x 2.50	50	10



Cajas surtidas dosificadoras de punteras aisladas



Ref. **ESD-666**

Caja dosificadora con 45 punteras DUO según detalle:

Ref. y sección		Largo mm.	Ref. y sección		Largo mm.
DUO-2 x 4.00	20	12	DUO-2 x 10.00	10	14
DUO-2 x 6.00	10	14	DUO-2 x 16.00	5	14



Ref. **ESD-6**

Caja dosificadora con 45 punteras TUO según detalle:

Ref. y sección		Largo mm.	Ref. y sección		Largo mm.
TUO-2 x 4.00	20	12	TUO-2 x 10.00	10	14
TUO-2 x 6.00	10	14	TUO-2 x 16.00	5	14



Ref. **ESD-10**



Caja grande dosificadora con 1.000 punteras según detalle:

Ref. y sección		Largo mm.
TE-1.00-8	1.000	8



Ref. **ESD-103**

Caja grande dosificadora con 1.000 punteras según detalle:

Ref. y sección		Largo mm.	Ref. y sección		Largo mm.
PD-0.75	200	8	PD-1.50	300	8
PD-1.00	300	8	PD-2.50	200	8



Cajas surtidas dosificadoras de punteras aisladas y sin aislar



Ref. **ESD-101**

Caja grande dosificadora con 1.000 punteras según detalle:

Ref. y sección		Largo mm.	Ref. y sección		Largo mm.
TE-0.75	200	8	TE-1.50	300	8
TE-1.00	300	8	TE-2.50	200	8



Ref. **USD-025**

Caja dosificadora con 2.500 punteras sin aislar según detalle:

Ref. y sección		Largo mm.	Ref. y sección		Largo mm.
P-0.25-5	500	5	P-0.75-6	500	6
P-0.34-5	500	5	P-1.00-6	500	6
P-0.50-6	500	6			



Ref. **USD-050**



Caja dosificadora con 1.900 punteras sin aislar según detalle:

Ref. y sección		Largo mm.	Ref. y sección		Largo mm.
P-0.50-6	500	6	P-1.50-7	300	7
P-0.75-6	500	6	P-2.50-7	200	7
P-1.00-6	400	6			



Ref. **USD-400**

Caja dosificadora con 350 punteras sin aislar según detalle:

Ref. y sección		Largo mm.	Ref. y sección		Largo mm.
P-4.00-9	150	9	P-10.00-12	75	12
P-6.00-12	75	12	P-16.00-12	50	12

¿Sabía qué...



...X.B. components, s.a. cuenta con una página web con catálogo online? Conectándose a la dirección www.xbcomponents.com podrá consultar el catálogo online, descargarlo en su ordenador en versión PDF, suscribirse al *newsletter* y acceder a todas las promociones de X.B.



EXPOSITORES
KITS PROFESIONALES



Expositor "EXPOCABLE"



Ref.
Expocable-2002-V

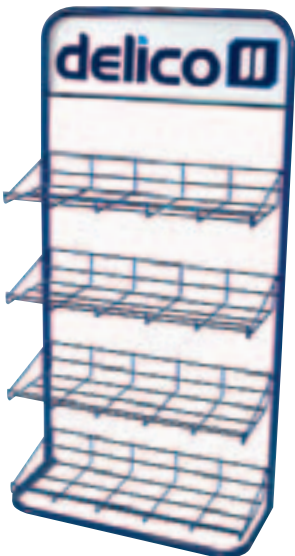

El expositor SE SUMINISTRA VACÍO y el contenido queda a voluntad del cliente.

Descripción:
Expositor-mostrador de sobremesa-pared, compuesto de 4 bandejas de varilla y cartela móvil, apto para 28 carretes de cable instalación y paralelo bicolor.

Dimensiones:
455 x 875 x 200 mm.

Contenido:
Para 28 carretes de 100, 50 y 25 mts. según necesidades.



Mini Expositor para 8 Carretes de Cable DELICO



Ref.
Expodelico-V

El expositor SE SUMINISTRA VACÍO y el contenido queda a voluntad del cliente.



Descripción:
Expositor de sobremesa de reducidas dimensiones

Dimensiones:
355 x 520 x 215 mm.

Contenido:
Para 8 carretes de 100, 50 y 25 mts. según necesidades.



Ref. **EXPOBRIC-2000** Especial para **ELECTRO-INDUSTRIA**



EXPOSITOR-MOSTRADOR DE SOBREMESA-PARED COMPUESTO DE 25 GANCHOS DOBLES Y CARTELA MOVIBLE.

- Dimensiones: 455 x 880 x 200 mm.
- Completa gama de terminales aislados, en nylon y entrada fácil de alta calidad para un perfecto conexionado eléctrico. Los 25 modelos más usuales en un expositor reducido y fácilmente acoplable.
- Composición: 150 blisters y 2.394 terminales.
- Todos los blisters que componen el expositor tienen el mismo P.V.P..

Ref.	Características y sección del terminal	Unidades por blister
01-EF-15019	puntera / 0,5 a 1,5 mm ²	20
02-EF-25019	puntera / 1,0 a 2,5 mm ²	18
03-EF-55027	puntera / 2,5 a 6,0 mm ²	10
04-EF-15017	empalme / 0,5 a 1,5 mm ²	20
05-EF-25023	empalme / 1,0 a 2,5 mm ²	18
06-EF-55034	empalme / 2,5 a 6,0 mm ²	10
07-EF-15032	redondo Ø 3,2 / 0,5 a 1,5 mm ²	20
08-EF-15043	redondo Ø 4,3 / 0,5 a 1,5 mm ²	20
09-EF-15053	redondo Ø 5,3 / 0,5 a 1,5 mm ²	20
10-EF-25043	redondo Ø 4,3 / 1,0 a 2,5 mm ²	20
11-EF-25053	redondo Ø 5,3 / 1,0 a 2,5 mm ²	20
12-EF-25064	redondo Ø 6,4 / 1,0 a 2,5 mm ²	15
13-EF-55043	redondo Ø 4,3 / 2,5 a 6,0 mm ²	12
14-EF-55053	redondo Ø 5,3 / 2,5 a 6,0 mm ²	12
15-EF-55064	redondo Ø 6,4 / 2,5 a 6,0 mm ²	10
16-EF-55084	redondo Ø 8,4 / 2,5 a 6,0 mm ²	8
17-EF-15043-A	horquilla Ø 4,3 / 0,5 a 1,5 mm ²	20
18-EF-15053-A	horquilla Ø 5,3 / 0,5 a 1,5 mm ²	18
19-EF-25043-A	horquilla Ø 4,3 / 1,0 a 2,5 mm ²	18
20-EF-25053-A	horquilla Ø 5,3 / 1,0 a 2,5 mm ²	18
21-EF-55043-A	horquilla Ø 4,3 / 2,5 a 6,0 mm ²	12
22-EF-55053-A	horquilla Ø 5,3 / 2,5 a 6,0 mm ²	12
23-EF-55064-A	horquilla Ø 6,4 / 2,5 a 6,0 mm ²	8
24-EF-25063	hembra enchufable 6,35 / 1,0 a 2,5 mm ²	20
25-EF-25635	macho enchufable 6,35 / 1,0 a 2,5 mm ²	20



Ref. **EXPOHOBBY-2000** Especial para **BRICOLAJE Y AUTO-INDUSTRIA**



EXPOSITOR-MOSTRADOR DE SOBREMESA-PARED COMPUESTO DE 25 GANCHOS DOBLES Y CARTELA MOVIBLE.

- Dimensiones: 455 x 880 x 200 mm.
- Terminales aislados fabricados en PVC.
- Terminales de alta calidad, para una perfecta conexión eléctrica.
- Total blisters: 150.
- Total terminales, conectores y cinta aislante: 762.

Ref.	Características y sección	Nº de blisters	Ud. por blister
26-PVC-15019	puntera / 0,5 a 1,5 mm ²	6	6
27-PVC-25019	puntera / 1,0 a 2,5 mm ²	6	6
28-PVC-55027	puntera / 2,5 a 6,0 mm ²	6	4
29-PVC-15017	empalme / 0,5 a 1,5 mm ²	6	6
30-PVC-25023	empalme / 1,0 a 2,5 mm ²	6	6
31-PVC-55034	empalme / 2,5 a 6,0 mm ²	6	4
32-PVC-15043	redondo Ø 4,3 / 0,5 a 1,5 mm ²	6	6
33-PVC-25043	redondo Ø 4,3 / 1,0 a 2,5 mm ²	6	6
34-PVC-55043	redondo Ø 4,3 / 2,5 a 6,0 mm ²	6	4
35-PVC-15043-A	horquilla Ø 4,3 / 0,5 a 1,5 mm ²	6	6
36-PVC-25043-A	horquilla Ø 4,3 / 1,0 a 2,5 mm ²	6	6
37-PVC-55043-A	horquilla Ø 4,3 / 2,5 a 6,0 mm ²	6	4
38-PVCC-15063	enchufable 6,3 / 0,5 a 1,5 mm ²	6	6
39-PVCC-25063	enchufable 6,3 / 1,0 a 2,5 mm ²	6	6
40-PVCC-55063	enchufable 6,3 / 2,5 a 6,0 mm ²	6	4
41-EFCC-15063-2	enchufable 6,3 / 0,5 a 1,5 mm ²	6	6
42-EFCC-25063-2	enchufable 6,3 / 1,0 a 2,5 mm ²	6	6
43-EFCC-55063-2	enchufable 6,3 / 2,5 a 6,0 mm ²	6	4
44-PVCC-15635	enchufable 6,3 / 0,5 a 1,5 mm ²	6	6
45-PVCC-25635	enchufable 6,3 / 1,0 a 2,5 mm ²	6	6
46-PVCC-55635	enchufable 6,3 / 2,5 a 6,0 mm ²	6	4
47-CR-100	conector rápido / 0,25 a 1,65 mm ²	6	4
48-CR-250	conector rápido / 1,04 a 2,63 mm ²	6	4
49-CR-600	conector rápido / 2,63 a 6,64 mm ²	6	2
50-13019-NG	cinta aislante 10 x 19	6	1



Ref. **EXPOCAR-2000** Especial para **ELECTRO-AUTO**



EXPOSITOR-MOSTRADOR DE SOBREMESA-PARED COMPUESTO DE 25 GANCHOS DOBLES Y CARTELA MOVIBLE.

- Dimensiones: 455 x 880 x 200 mm.
- Completa gama de terminales desnudos con garras, conectores rápidos y protecciones de alta calidad para un perfecto conexionado eléctrico. Los 25 modelos más usuales en un expositor reducido y fácilmente acoplable.
- 150 blísters y 3.432 terminales, conectores y protecciones.

Ref.	Características y sección	Sección mm ²	Ud. por blister
51-14408-00	hembra 2,8 x 0,5	0,5 mm ²	40
52-14412-00	hembra 4,8 x 0,5	0,5 mm ²	25
53-14648-00	hembra 6,3 x 0,8	1,0 mm ²	35
54-14308-00	hembra 2,8 x 0,5	0,5 mm ²	40
55-14370-00	hembra 5,0 x 0,8	1,0 mm ²	20
56-14327-00	hembra 6,3 x 0,8	1,0 mm ²	20
57-15060-00	macho 2,8 x 0,5	0,5 mm ²	30
58-16413-00	macho 4,8 x 0,5	0,5 mm ²	20
59-16422-00	macho 6,3 x 0,8	1,0 mm ²	20
60-16466-00	macho 5,0 x 0,8	1,0 mm ²	20
61-16432-00	macho 6,3 x 0,8	1,0 mm ²	20
62-13437-00	redondo Ø 4,2	0,75 mm ²	25
63-13374-00	redondo Ø 5,2	0,75 mm ²	25
64-13378-00	redondo Ø 6,2	0,75 mm ²	25
65-13310-00	redondo Ø 8,5	1,0 mm ²	10
66-13840-00	horquilla Ø 4,2	0,5 mm ²	25
67-15222-00	mixto macho-hembra 6,3 x 0,8	0,75 mm ²	10
68-3838-6-00	mixto macho-hembra 6,3 x 0,8	-	10
69-CR-100	conector rápido	0,5 mm ²	6
70-CR-250	conector rápido	1,0 mm ²	6
71-CS-28N002	protector frontal hembra	2,8 mm ²	30
72-CS-48N002	protector frontal hembra	4,8 mm ²	30
73-CS-63N004-02	protector frontal hembra	6,3 mm ²	25
74-PM-1080	protector para macho	6,3 mm ²	20
75-PH-1020	protector para hembra	6,3 mm ²	35





Ref. **EXPOHER-2000** Especial para **ELECTRO-INDUSTRIA**



EXPOSITOR-MOSTRADOR DE SOBREMESA-PARED, COMPUESTO DE 12 GANCHOS DOBLES Y CARTELA MOVIBLE.

- Dimensiones: 455 x 980 x 200 mm.
- 12 modelos de herramientas de corte, desferrado y engrapado para cables, terminales y punteras de multiples secciones.
- Herramientas de última generación y de probada calidad profesional.
- Contenido: 48 herramientas.

Ref.	Características y sección del terminal	Nº de blisters
SN-02-C	mini herramienta para terminales aislados de secciones 0,25 a 2,5 mm ² .	4
SN-06-WF	mini herramienta para punteras aisladas de secciones 0,50 a 6,00 mm ² .	4
SN-16-WF	mini herramienta para punteras aisladas de secciones 6,00 a 16,00 mm ² .	4
SN-02-WF-2C	mini herramienta COMBI para punteras y terminales aislados de 0,25 a 2,5 mm ² .	4
DL-6	mini herramienta auto ajustable para punteras aisladas de secciones 0,75 a 10,00 mm ² .	4
DL-16	mini herramienta autoajustable para punteras aisladas de secciones 4,0 a 16,0 mm ² .	4
SN-02-B	mini herramienta para terminales con garras de secciones 0,5 a 2,5 mm ² .	4
SN-06	mini herramienta para terminales tubulares y de presión DIN de secciones 1,25 a 6,0 mm ² .	4
ME-22-C	cortadora manual con mangos blandos para cables de cobre de máximo 22 mm ² . Se mantiene cerrada.	4
JOK-28-H	peladora de cables redondos, de corte transversal y longitudinal con cuchilla de recambio.	4
JRK-806-N	cutter de excepcional calidad profesional, cuchillas de acero Sk-2 y tope de seguridad.	4
MEK-50-P	cuchillo especial para electricistas. Hoja de acero con muescas para pelado de cables. Resistente a la corrosión. Hoja plegable.	4





Ref. **EXPOAUTO-2000** Especial para **ELECTRO-AUTO**



EXPOSITOR-MOSTRADOR DE SOBREMESA-PARED COMPUESTO DE 25 GANCHOS DOBLES Y CARTELA MOVIBLE.

- Dimensiones: 455 x 880 x 200 mm.
- Fusibles, portafusibles, conectores y protecciones en "kits" de alta calidad para el automóvil.
- Contenido: 150 blísters y 1.188 unidades surtidas.

Ref.	Composición	Nº de blísters
XB-500	10 fusibles serie 03-45	6
XB-501	10 fusibles serie 03-40	6
XB-502	2 fusibles serie 03-50	6
XB-503	2 fusibles serie 03-50	6
XB-504	10 fusibles serie 03-30 y 03-26	6
XB-505	2 fusibles y 2 portafusibles	6
XB-506	2 fusibles y 2 portafusibles	6
XB-507	2 fusibles y 2 portafusibles	6
XB-508	2 fusibles y 2 portafusibles	6
XB-509	2 conectores y 2 terminales	6
XB-510	2 conectores y 4 terminales	6
XB-511	2 conectores y 4 terminales	6
XB-512	2 conectores y 6 terminales	6
XB-513	2 conectores y 8 terminales	6
XB-514	2 conectores y 12 terminales	6
XB-515	2 conectores y 16 terminales	6
XB-516	8 terminales aislados en nylon	6
XB-517	8 terminales aislados en nylon	6
XB-518	8 terminales aislados en nylon	6
XB-519	8 terminales aislados en nylon	6
XB-520	12 terminales aislados en PVC	6
XB-521	6 conectores rápidos	6
XB-522	3 conectores y 3 terminales	6
XB-523	4 derivaciones	6
XB-524	12 terminales y 12 protecciones	6





Ref. **EXPOSEAL-2000** Especial para **ELECTRO-AUTO**



EXPOSITOR-MOSTRADOR DE SOBREMESA-PARED, COMPUESTO DE 25 GANCHOS DOBLES Y CARTELA MOVIBLE.

- Dimensiones: 455 x 880 x 200 mm.
- Kits completos de conectores, terminales y gomino tipo "SUPER SEAL" estancos. De nueva generación.
- Alta calidad para automóvil.
- Total blisters: 150. Total conectores, terminales y gomino: 1.002.

Ref.	Composición	Nº de blisters
XB-525-M	1 conector, 1 terminal y 1 seal "gomino"	6
XB-526-F	1 conector, 1 terminal y 1 seal "gomino"	6
XB-527-M	1 conector, 2 terminales y 2 seal "gomino"	6
XB-528-F	1 conector, 2 terminales y 2 seal "gomino"	6
XB-529-M	1 conector, 3 terminales y 3 seal "gomino"	6
XB-530-F	1 conector, 3 terminales y 3 seal "gomino"	6
XB-531-M	1 conector, 4 terminales y 4 seal "gomino"	6
XB-532-F	1 conector, 4 terminales y 4 seal "gomino"	6
XB-533-M	1 conector, 5 terminales y 5 seal "gomino"	6
XB-534-F	1 conector, 5 terminales y 5 seal "gomino"	6
XB-535-M	1 conector, 6 terminales y 6 seal "gomino"	6
XB-536-F	1 conector, 6 terminales y 6 seal "gomino"	6
XB-537-M	1 conector, 1 terminal y 1 seal "gomino"	6
XB-538-F	1 conector, 1 terminal y 1 seal "gomino"	6
XB-539-M	1 conector, 2 terminales y 2 seal "gomino"	6
XB-540-F	1 conector, 2 terminales y 2 seal "gomino"	6
XB-541-M	1 conector, 3 terminales y 3 seal "gomino"	6
XB-542-F	1 conector, 3 terminales y 3 seal "gomino"	6
XB-543	6 seal "gomino"	6
XB-544	6 seal "gomino"	6
XB-545	6 seal "gomino"	6
XB-546	6 seal "gomino"	6
XB-547	6 seal "gomino"	6
XB-548	6 seal "gomino"	6
XB-549	KIT COMPLETO	6



Ref. **EXPOPUNT-2000** Especial para **ELECTRO-INDUSTRIA**



EXPOSITOR-MOSTRADOR DE SOBREMESA-PARED, COMPUESTO DE 25 GANCHOS DOBLES Y CARTELA MOVIBLE.

- Dimensiones: 455 x 880 x 200 mm.
- Punteras aisladas tipos TE y DUO de secciones de 0,14 a 70 mm², de alta calidad para una perfecta conexión eléctrica.
- Contenido: 150 blísters y 9.510 punteras.

Ref.	Características y sección	Nº de blísters	Ud. por blister
76-TE-0,14	puntera TE de 0,14 mm ²	6	100
77-TE-0,25	puntera TE de 0,25 mm ²	6	100
78-TE-0,34	puntera TE de 0,34 mm ²	6	100
79-TE-0,50	puntera TE de 0,50 mm ²	6	100
80-TE-0,75	puntera TE de 0,75 mm ²	6	100
81-TE-1,00	puntera TE de 1,00 mm ²	6	100
82-TE-1,50	puntera TE de 1,50 mm ²	6	100
83-TE-2,50	puntera TE de 2,50 mm ²	6	100
84-TE-4,00	puntera TE de 4,00 mm ²	6	100
85-TE-6,00	puntera TE de 6,00 mm ²	6	50
86-TE-10,00	puntera TE de 10,00 mm ²	6	50
87-TE-16,00	puntera TE de 16,00 mm ²	6	25
88-TE-25,00	puntera TE de 25,00 mm ²	6	15
89-TE-35,00	puntera TE de 35,00 mm ²	6	10
90-TE-50,00	puntera TE de 50,00 mm ²	6	5
91-TE-70,00	puntera TE de 70,00 mm ²	6	5
92-DUO-2 x 0,50	puntera DUO de 0,50 mm ²	6	100
93-DUO-2 x 0,75	puntera DUO de 0,75 mm ²	6	100
94-DUO-2 x 1,00	puntera DUO de 1,00 mm ²	6	100
95-DUO-2 x 1,50	puntera DUO de 1,50 mm ²	6	100
96-DUO-2 x 2,50	puntera DUO de 2,50 mm ²	6	50
97-DUO-2 x 4,00	puntera DUO de 4,00 mm ²	6	25
98-DUO-2 x 6,00	puntera DUO de 6,00 mm ²	6	25
99-DUO-2 x 10,00	puntera DUO de 10,00 mm ²	6	10
100-DUO-2 x 16,00	puntera DUO de 16,00 mm ²	6	5





Ref. **EXPOGUIA-2000** Especial para **ALMACENES ELÉCTRICOS**



EPOSITOR-MOSTRADOR DE PIE-PARED, COMPUESTO DE 8 GANCHOS DOBLES Y CARTELA MOVIBLE.

- Dimensiones: 1.420 x 560 x 350 mm.
- Amplio surtido de guías y mallas pasacables. Especialmente diseñado para almacenes eléctricos.
- Contenido: 48 guías y 12 mallas.

Ref.	Descripción	Posición	Nº de piezas
GPN-05-M	guías de 5 metros	1	10
GPN-10-M	guías de 10 metros	2	10
GPN-15-M	guías de 15 metros	3	10
GPN-20-M	guías de 20 metros	4	6
GPN-25-M	guías de 25 metros	5	6
GPN-30-M	guías de 30 metros	6	6
MGP-1	mallas para arrastre de cables	7	6
MGP-2	mallas para arrastre de cables	8	6





Ref. **BRICOLOR-2000** **MULTIUSOS**



EXPOSITOR-MOSTRADOR DE PIE, COMPUESTO DE 18 GANCHOS DOBLES, 1 SENCILLO Y BANDEJA DE 63 x 31 mm. Y CARTELA MOVIBLE.

- Dimensiones: 650 x 1.850 x 340 mm.
- El más completo surtido de bridas en colores y medidas.
- Contenido: 196 bolsas y botes y un total de 15.850 unidades.

Ref.	Posición	Total bridas	Nº de bolsas y botes	Cantidad por bolsa
VP-50-48N	1	500	10	50
VP-50-48BK	2	500	10	50
VP-50-48Y	3	500	10	50
VP-50-48R	4	500	10	50
VP-50-48C	5	500	10	50
VP-50-8BK	6	500	10	50
VP-50-4BK	7	500	10	50
VP-50-4N	8	500	10	50
BP-25	9	100	4	25
BP-100	9	400	4	100
VP-50-11N	10	500	10	50
VP-50-11BK	11	500	10	50
VP-50-811N	12	500	10	50
VP-50-811BK	13	500	10	50
VP-50-811Y	14	500	10	50
VP-50-811BL	15	500	10	50
VP-50-811R	16	500	10	50
VP-50-4811C	17	500	10	50
VP-50-811C	18	500	10	50
VP-150-4811C	19	900	6	150
BP-650	20	650	1	650
BP-850	21	850	1	850
CP-1000	22	2.000	2	1.000
CP-1000	23	2.000	2	1.000
BP-75-NATURAL	24	150	2	75
BP-75-NEGRO	24	150	2	75
BP-75-MIXED	24	150	2	75





Ref. **AUTODIS-2000** **MULTIUSOS**



EXPOSITOR-MOSTRADOR DE SOBREMESA-PARED, COMPUESTO DE 15 GANCHOS DOBLES Y CARTELA MOVIBLE.

- Dimensiones: 500 x 880 x 220 mm.
- Completo surtido de accesorios de fijación: bridas, bases y tacos en colores natural y negro desde 75 a 310 mm.
- Contenido: 210 bolsas, 4.500 bridas y 600 accesorios.

Ref. y color	Características y sección	Nº de bolsas	Ud. por bolsa
<input type="checkbox"/> B-CV-100	brida sujetacable de 100 x 2,5 mm.	20	25
<input type="checkbox"/> B-CV-140	brida sujetacable de 142 x 3,2 mm.	20	25
<input type="checkbox"/> B-CV-200	brida sujetacable de 203 x 4,6 mm.	10	25
<input type="checkbox"/> B-CV-250	brida sujetacable de 250 x 4,8 mm.	10	25
<input type="checkbox"/> B-CV-310	brida sujetacable de 310 x 4,8 mm.	10	25
<input checked="" type="checkbox"/> B-CV-310B	brida sujetacable de 310 x 4,8 mm.	10	25
<input checked="" type="checkbox"/> B-CV-250B	brida sujetacable de 250 x 4,8 mm.	10	25
<input checked="" type="checkbox"/> B-CV-200B	brida sujetacable de 203 x 4,6 mm.	10	25
<input checked="" type="checkbox"/> B-CV-140B	brida sujetacable de 142 x 3,2 mm.	20	25
<input checked="" type="checkbox"/> B-CV-100B	brida sujetacable de 100 x 2,5 mm.	20	25
<input checked="" type="checkbox"/> B-CV-075B	brida sujetacable de 75 x 2,4 mm.	20	25
<input type="checkbox"/> B-CV-075	brida sujetacable de 75 x 2,4 mm.	20	25
<input type="checkbox"/> B-HC-1	base de fijación por tornillo para bridas	10	10
<input type="checkbox"/> B-HC-101	base adhesiva para soporte de bridas	10	10
<input checked="" type="checkbox"/> B-CH-8	tacos a presión	10	10





Ref. **EXPOTERM-CS-2000** Especial para **ELECTRO-INDUSTRIA Y ELECTRO-AUTO**



EXPOSITOR-MOSTRADOR DE SOBREMESA-PARED, COMPUESTO DE 4 BANDEJAS DE VARILLA Y CARTELA MOVIBLE.

- Dimensiones: 455 x 875 x 200 mm.
- Cajas dosificadoras de tubo termoretráctil de poliolefina 125°C de alta calidad.
- Contenido: 28 cajas y 315 mts. de tubo en total.

Ref. y color	Ø Descripción	Nº de cajas	Metros por caja
■ XBC-2,4-NG	tubo 2,4	2	15
■ XBC-3,2-NG	tubo 3,2	4	15
■ XBC-4,8-NG	tubo 4,8	4	12
■ XBC-6,4-NG	tubo 6,4	4	12
■ XBC-9,5-NG	tubo 9,5	3	8
■ XBC-12,7-NG	tubo 12,7	2	8
■ XBC-19,0-NG	tubo 19,0	1	5
■ XBC-25,4-NG	tubo 25,4	1	3
■ XBC-3,2-AV	tubo 3,2	1	15
■ XBC-4,8-AV	tubo 4,8	2	12
■ XBC-6,4-AV	tubo 6,4	2	12
■ XBC-9,5-AV	tubo 9,5	1	8
■ XBC-12,7-AV	tubo 12,7	1	8





Expositor EXPOTERM 2004



Ref.: **EXPOTERM-2004**

40 COMPARTIMENTOS PARA BARRAS DE 1 METRO DE TERMORETRÁCTIL DE VARIOS COLORES.

9 cajas dosificadoras de termoretráctil Toma Tierra amarillo/verde.

1.125 barras de 1 metro de las siguientes medidas: 1.6 - 2.4 - 3.2 - 4.8 - 6.4 - 9.5 - 12.7 - 19.0 y 25.4 en colores amarillo, azul, blanco, negro y rojo.

102 metros de Toma Tierra amarillo/verde.

OPCIONAL:

Expoterm-2004-NG.

Todas las referencias y cajas en termoretráctil negro.



Expoterm

2004

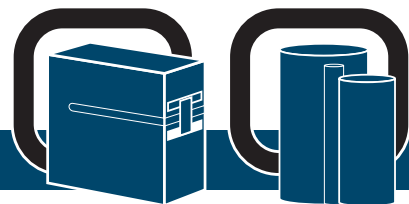

XBPT-1.6-NG-1 100 unidades	XBPT-3.2-RO-1 50 unidades	XBPT-4.8-RO-1 40 unidades	XBPT-6.4-RO-1 25 unidades	XBPT-9.5-RO-1 20 unidades	XBPT-12.7-RO-1 15 unidades	XBPT-19.0-RO-1 10 unidades	XBPT-25.4-RO-1 5 unidades
XBPT-2.4-NG-1 50 unidades	XBPT-3.2-NG-1 50 unidades	XBPT-4.8-NG-1 40 unidades	XBPT-6.4-NG-1 25 unidades	XBPT-9.5-NG-1 20 unidades	XBPT-12.7-NG-1 15 unidades	XBPT-19.0-NG-1 10 unidades	XBPT-25.4-NG-1 5 unidades
XBPT-2.4-BL-1 50 unidades	XBPT-3.2-BL-1 50 unidades	XBPT-4.8-BL-1 40 unidades	XBPT-6.4-BL-1 25 unidades	XBPT-9.5-BL-1 20 unidades	XBPT-12.7-BL-1 15 unidades	XBPT-19.0-BL-1 10 unidades	XBPT-25.4-BL-1 5 unidades
XBPT-2.4-AZ-1 50 unidades	XBPT-3.2-AZ-1 50 unidades	XBPT-4.8-AZ-1 40 unidades	XBPT-6.4-AZ-1 25 unidades	XBPT-9.5-AZ-1 20 unidades	XBPT-12.7-AZ-1 15 unidades	XBPT-19.0-AZ-1 10 unidades	XBPT-25.4-AZ-1 5 unidades
XBPT-2.4-AM-1 50 unidades	XBPT-3.2-AM-1 50 unidades	XBPT-4.8-AM-1 40 unidades	XBPT-6.4-AM-1 25 unidades	XBPT-9.5-AM-1 20 unidades	XBPT-12.7-AM-1 15 unidades	XBPT-19.0-AM-1 10 unidades	XBPT-25.4-AM-1 5 unidades

Expositores vacíos

Ref. **EXPOCABLE-2002-V**

MULTIUSOS

Dimensiones:
455x880x200mm.

 1

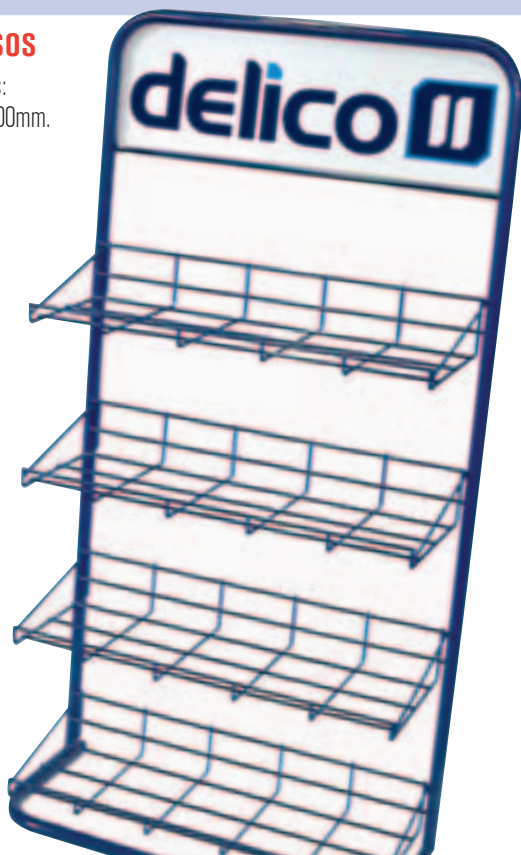

Ref. **EXPODELICO-2002-V**

MULTIUSOS

Dimensiones:
355x520x215mm.

 1



Ref. **EXPOBRIC-2000-V**

MULTIUSOS

Dimensiones:
455x880x200mm.

 1

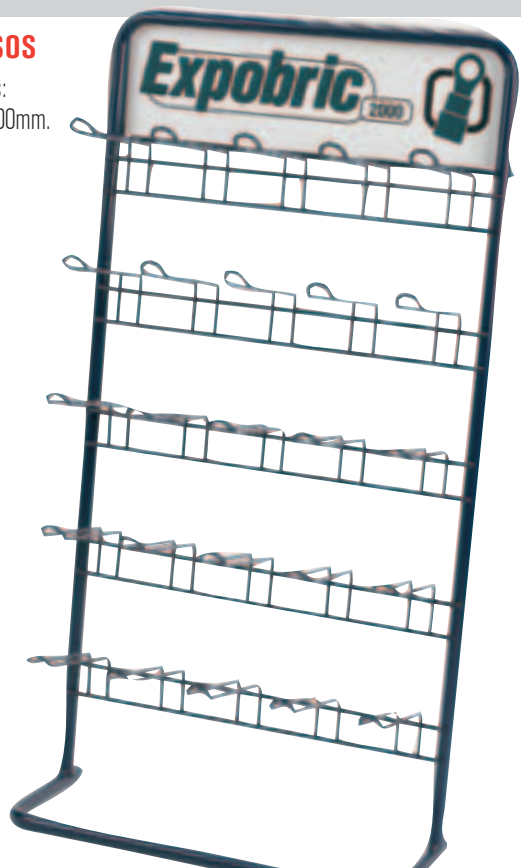

Ref. **EXPOHER-2000-V**

MULTIUSOS

Dimensiones:
455x980x200mm.

 1

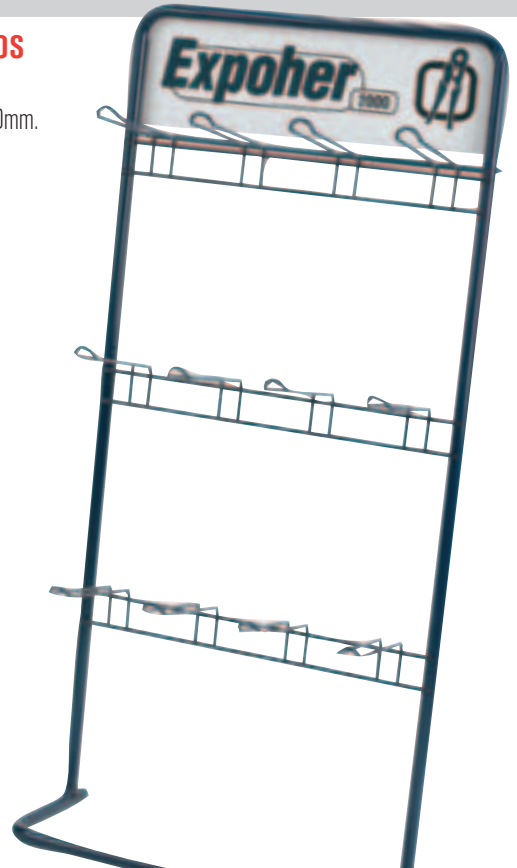



Expositores vacíos

Ref. **EXPOGUÍA-2000-V**

MULTIUSOS

Dimensiones:
560x1400x350mm.

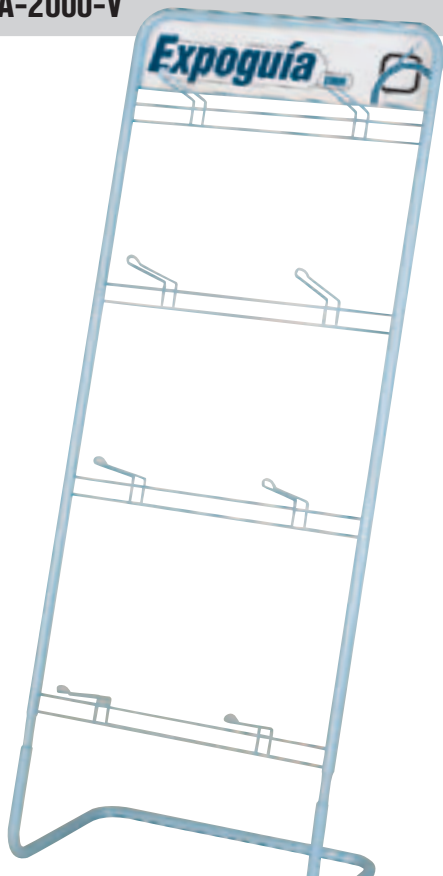

Ref. **AUTODIS-2000-V**

MULTIUSOS

Dimensiones:
500x880x220mm.

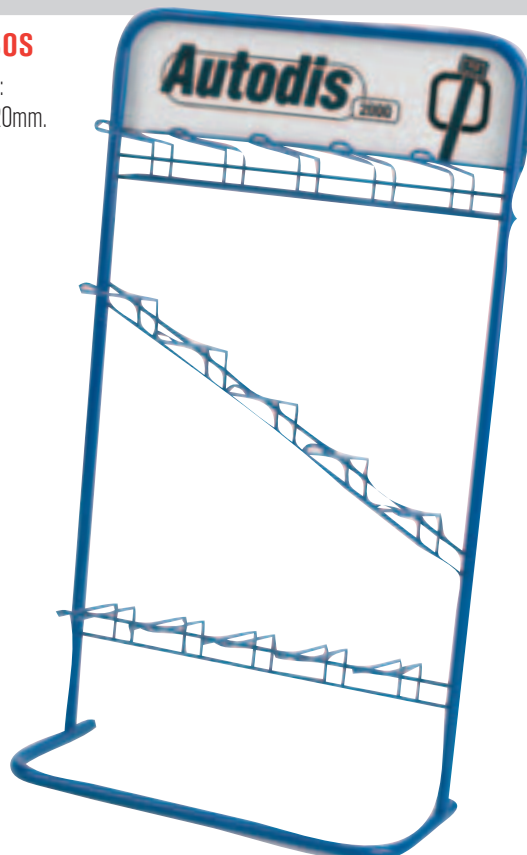

Ref. **BRICOLOR-2000-V**

MULTIUSOS

Dimensiones:
650x1850x340mm.

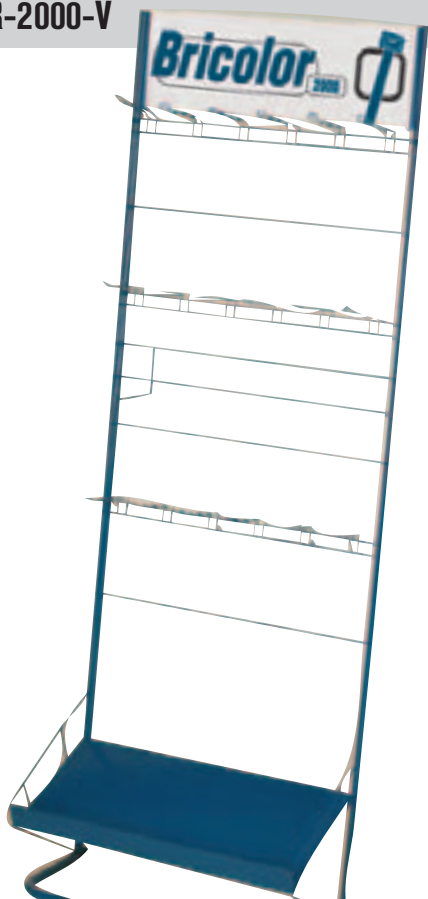

Ref. **EXPOTERM-CS-2000-V**

MULTIUSOS

Dimensiones:
455x875x200mm.

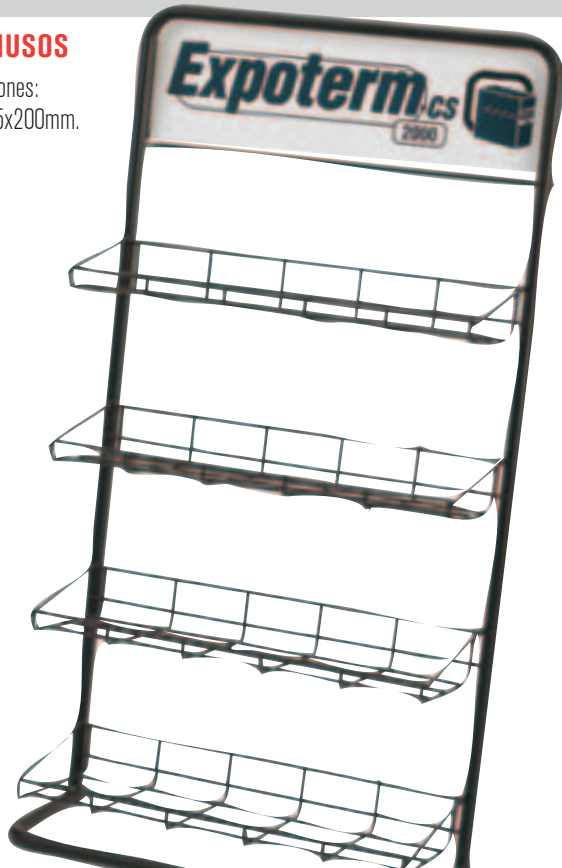



Expositores vacíos

Ref. **EXPOTERM-2004-V**

Dimensiones:
540x1450x260mm.





KITS profesionales



KIT-LY03C-5D ⚖️ 1220 gr 📦 1

Estuche compuesto de:
1 herramienta LY-03-C
1 matriz LY-04-WF
1 matriz LY-16-WF
1 matriz LY-03-B
1 matriz LY-10

Aplicaciones:



LY-03-C



LY-04-WF



LY-16-WF



LY-03-B



LY-10



KIT-SN02C-5D ⚖️ 749 gr 📦 1

Estuche compuesto de:
1 herramienta SN-02-C
1 matriz SN-06-WF
1 matriz SN-02-WF
1 matriz SN-02-B
1 matriz SN-02

Aplicaciones:



SN-02-C

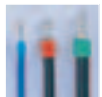

SN-06-WF



SN-02-WF



SN-02-B



SN-02

KITS profesionales



KIT-AN03C-5D ⚖️ 1174 gr 📦 1

Estuche compuesto de:
1 herramienta AN-03-C
1 matriz LY-04-WF
1 matriz LY-16-WF
1 matriz LY-03-B
1 matriz LY-10

Aplicaciones:



AN-03-C



LY-04-WF



LY-16-WF



LY-03-B



LY-10



KIT-BN03C-5D ⚖️ 1214 gr 📦 1

Estuche compuesto de:
1 herramienta BN-03-C
1 matriz LY-04-WF
1 matriz LY-16-WF
1 matriz LY-03-B
1 matriz LY-10

Aplicaciones:



BN-03-C



LY-04-WF



LY-16-WF



LY-03-B



LY-10



KITS profesionales



KIT-LY-05H-5A  1426 gr  1

Estuche compuesto de:
1 herramienta LY-05-H
1 herramienta LY-322
1 herramienta LY-206
1 matriz LY-02-H
1 matriz LY-02-H1
1 matriz LY-1741
1 matriz LY-457

Aplicaciones:
Ver herramientas catálogo nº 4



KIT-568-3B  888 gr  1

Estuche compuesto de:
1 herramienta LY-568
1 herramienta LY-364-B
1 herramienta LY-501

Aplicaciones:
Ver herramientas catálogo nº 4

KITS profesionales



KIT-568-3A

812 gr 1

Estuche compuesto de:

1 herramienta LY-568

1 herramienta LY-314-KR

1 herramienta LY-501

Aplicaciones:

Ver herramientas catálogo nº 4



L-10 CUTTER

655 gr 1

Kit multiusos de corte para:

Canaletas, moquetas plásticas, mangueras trenzadas, tubos plásticos, etc.

Aplicaciones:

Ver herramientas catálogo nº 4

¿Sabía qué...



...X.B. components, s.a. dispone de más de 12.000 referencias agrupadas en 8 catálogos, tanto en versión impresa y CD ROM como en versión PDF descargable desde la página WEB?



BLISTERS

BOTES, CAJAS Y BOLSAS



Botes y cajas



Ref. **CP-300**

MULTIUSOS

Contenido: 300 bridas de 100 x 2,5 y 203 x 3,2 mm.
en colores surtidos: natural, rojo, amarillo, azul, verde.



Ref. **CP-400**

MULTIUSOS

Contenido: 400 bridas de 100 x 2,5 mm. y 203 x 3,2 mm.
en colores surtidos: rojo, azul, verde, natural.



Ref. **CP-1000**

MULTIUSOS

Contenido: 1.000 bridas sujetacables de 100 x 2,5 mm.
en 10 colores diferentes: negro, rojo, amarillo, azul,
 verde, rojo, amarillo, azul, gris, natural.



Ref. **BP-650**

MULTIUSOS

Contenido: 650 bridas de 100 x 2,5 mm., 203 x 3,2 mm.
y 280 x 3,2 mm. en colores surtidos: natural, rojo, amarillo,
 azul, verde.



Botes y cajas



Ref. **BP-850**

MULTIUSOS

Contenido: 850 bridas de 100 x 2,5 mm., 203 x 3,2 mm. y 280 x 3,2 mm. en colores surtidos: natural, rojo, amarillo, azul, verde.



Ref. **BP-1000**

MULTIUSOS

Contenido: 1.000 bridas de 100 x 2,5 mm., 203 x 4,6 mm. y 280 x 5,0 mm. en colores surtidos: natural, rojo, amarillo, azul, verde.



Ref. **BP-1200**

MULTIUSOS

Contenido: 1.200 bridas de 100 x 2,5 mm., 203 x 4,6 mm. y 280 x 5,0 mm. en colores surtidos: natural, negro, rojo, verde, amarillo.



Ref. **BP-650S**

MULTIUSOS

Contenido: 650 bridas 100 x 2,5 mm. y 180 x 3,6 mm. 5 colores deferentes: natural, rojo, amarillo, azul, verde.



Botes y cajas



Ref. **BP-500SQ**

MULTIUSOS

Contenido: 500 bridas 100x2.5 - 142x3.2 - 180x3.6
5 colores diferentes: natural, rojo, azul, amarillo, negro.



Ref. **BP-1001**

MULTIUSOS

Contenido: 1001 bridas 100x2.5 - 203x4.6 -- 280x4.8
 natural, rojo, amarillo, azul.



Ref. **DB-350**

MULTIUSOS

Contenido: 350 bridas de 100 x 2,5 mm., 203 x 4,6 mm.
y 280 x 5,0 mm. en colores surtidos: natural, rojo, azul,
 amarillo, negro.



Ref. **BP-75 natural**

MULTIUSOS

Contenido: 75 bridas.

Ref.	Color	Dimensiones	
<input type="checkbox"/> CV-094	natural	96 x 2,5 mm.	25
<input type="checkbox"/> CV-120L	natural	120 x 4,8 mm.	25
<input type="checkbox"/> CV-190	natural	190 x 4,8 mm.	25



Botes y cajas



Ref. **BP-75 negro**

MULTIUSOS

Contenido: 75 bridas.

Ref.	Color	Dimensiones	
■ CV-094B	negro	96 x 2,5 mm.	25
■ CV-120LB	negro	120 x 4,8 mm.	25
■ CV-190B	negro	190 x 4,8 mm.	25



Ref. **BP-75 multicolor**

MULTIUSOS

Contenido: 75 bridas.

Ref.	Color	Dimensiones	
□ CV-094	natural	96 x 2,5 mm.	25
■ CV-120L-6	rojo	120 x 4,8 mm.	25
■ CV-190-7	amarillo	190 x 4,8 mm.	25



Ref. **BP-25**

INSTALACIONES

Contenido: 25 grapas para cables redondos y tipo telefónicos.

Ref.	Color	
■ NT-1	gris	5
■ NC-0,5N	gris	10
■ NC-1,5N	gris	5
■ NC-3N	gris	5



Ref. **BP-100**

INSTALACIONES Contenido: 100 unidades entre bridas, conectores rápidos ciegos para engrapación y grapas de sujeción.

Ref.	Color	
□ CV-075	natural	30
□ CV-100	natural	20
□ CR-250	natural	10
□ NCE-2	natural	9
□ NCE-5	natural	9
□ UC-0,5	natural	6
□ UC-1	natural	8
□ UC-2	natural	8



Botes y cajas



Ref. **BNC-100**

INSTALACIONES

Contenido: 100 grapas surtidas para cables.

Ref.	Color	
<input type="checkbox"/> NC-0507	blanco	50
<input type="checkbox"/> NC-1,5N	blanco	50



Ref. **PB-5AP**

INSTALACIONES

Contenido: 5 abrazaderas ajustables.

Ref.	Color	
<input type="checkbox"/> AP-1720-WT	blanco	5



Ref. **PB-10NF**

INSTALACIONES

Contenido: 10 grapas para cable telefónico.

Ref.	Color	
<input type="checkbox"/> NF-0,7	blanco	10



Ref. **SNC-0,4N / SNC-0,5N / SNC-1N**

INSTALACIONES (caja pequeña)

Contenido: 100 grapas por caja.

Ref.	Color	
<input type="checkbox"/> SNC-0,4N	blanco	100
<input type="checkbox"/> SNC-0,5N	blanco	100
<input type="checkbox"/> SNC-1N	blanco	100



Botes y cajas



Ref. **LNC-3N / LNC-3.5N / LNC-4N**

INSTALACIONES (caja grande)

Contenido: 100 grapas por caja.

Ref.	Color	
<input type="checkbox"/> LNC-3N	blanco	100
<input type="checkbox"/> LNC-3,5N	blanco	100
<input type="checkbox"/> LNC-4N	blanco	100



Ref. **MNC-1.5N / MNC-2N / MNC-2.5N**

INSTALACIONES (caja mediana)

Contenido: 100 grapas por caja.

Ref.	Color	
<input type="checkbox"/> MNC-1,5N	blanco	100
<input type="checkbox"/> MNC-2N	blanco	100
<input type="checkbox"/> MNC-2,5N	blanco	100



Ref. **SB-400**

INSTALACIONES

Contenido: 400 grapas surtidas.

Ref.	Color	
<input type="checkbox"/> NC-1N	blanco	100
<input type="checkbox"/> NC-1,5N	blanco	100
<input type="checkbox"/> NC-2N	blanco	100
<input type="checkbox"/> NC-2,5N	blanco	100



Ref. **SB-500-28**

INSTALACIONES

Contenido: 500 grapas para cable con clavo.

Ref.	Color	
<input type="checkbox"/> NF-2,85	blanco	500



Botes y cajas



Ref. **DS-180NT**

INSTALACIONES

Contenido: 180 grapas para cable con clavo.

Ref.	Color	
■ NT-0711	gris	180



Ref. **SB-500**

INSTALACIONES

Contenido: 500 grapas.

Ref.	Color	
□ NC-0810	natural	500



Ref. **SB-800**

INSTALACIONES

Contenido: 800 grapas.

Ref.	Color	
■ NC-0,4N	gris	300
■ NC-0,5N	gris	300
□ NF-2,0	blanco	100
□ NF-2,2	blanco	100



Ref. **SB-850**

INSTALACIONES

Contenido: 850 grapas.

Ref.	Color	
■ NC-0,4N	gris	300
■ NC-1,5N	gris	150
■ NC-2,5N	gris	100
■ NC-1,2B	negro	300



Botes y cajas



Ref. **SB-1200**

INSTALACIONES

Contenido: 1200 grapas.

Ref.	Color	
■ NC-0,5N	gris	1200



Blisters para expositores

ACLARACIONES:

Los blisters de referencias **01-EF-15019** a **25-EF-25635** son para el expositor **EXPOBRIC-2000**.

Los blisters de referencias **26-PVC-15019** a **50-131019-NG** son para el expositor **EXPOHOBBY-2000**.

Los blisters de referencias **51-14408-00** a **75-PH-1020** son para el expositor **EXPOCAR-2000**.

Los blisters de referencias **76-TE-0,14** a **100-DUO-2x16,00** son para el expositor **EXPOPUNT-2000**.

Los blisters de referencias **XB-500** a **XB-524** son para el expositor **EXPOAUTO-2000**.

Los blisters de referencias **XB-525** a **XB-549** son para el expositor **EXPOSEAL-2000**.

Los blisters de referencias **B-CV-075** a **B-CH-8** son para el expositor **AUTODIS-2000**.

Los blisters de referencias **VP-50-48N** a **VP-150-4811C** son para el expositor **BRICOLOR-2000**.



Ref. **01-EF-15019**

20 terminales puntera.
Sección de 0,5 a 1,5 mm².



Ref. **02-EF-25019**

18 terminales puntera.
Sección de 1,0 a 2,5 mm².



Ref. **03-EF-55027**

10 terminales puntera.
Sección de 2,5 a 6,0 mm².



Blisters para expositores

Refs. **01-EF-15019** a **25-EF-25635**: para **EXPOBRIC-2000**



Ref. **04-EF-15017**

20 terminales empalme.
Sección de 0,5 a 1,5 mm².



Ref. **05-EF-25023**

18 terminales empalme.
Sección de 1,0 a 2,5 mm².



Ref. **06-EF-55034**

10 terminales empalme.
Sección de 2,5 a 6,0 mm².



Ref. **07-EF-15032**

20 terminales redondos Ø 3,2 mm.
Sección de 0,5 a 1,5 mm².



Ref. **08-EF-15043**

20 terminales redondos Ø 4,3 mm.
Sección de 0,5 a 1,5 mm².



Ref. **09-EF-15053**

20 terminales redondos Ø 5,3 mm.
Sección de 0,5 a 1,5 mm².

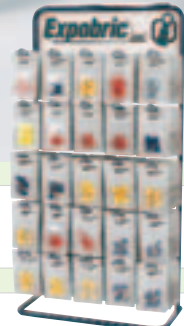

Blisters para expositores

Refs. **01-EF-15019** a **25-EF-25635**: para **EXPOBRIC-2000**



Ref. **10-EF-25043**

20 terminales redondos Ø 4,3 mm.
Sección de 1,0 a 2,5 mm².



Ref. **11-EF-25053**

20 terminales redondos Ø 5,3 mm.
Sección de 1,0 a 2,5 mm².



Ref. **12-EF-25064**

15 terminales redondos Ø 6,4 mm.
Sección de 1,0 a 2,5 mm².



Ref. **13-EF-55043**

12 terminales redondos Ø 4,3 mm.
Sección de 2,5 a 6,0 mm².



Ref. **14-EF-55053**

12 terminales redondos Ø 5,3 mm.
Sección de 2,5 a 6,0 mm².



Ref. **15-EF-55064**

10 terminales redondos Ø 6,4 mm.
Sección de 2,5 a 6,0 mm².

10 Estuches - Expositores - Blisters



Blisters para expositores

Refs. **01-EF-15019** a **25-EF-25635**: para **EXPOBRIC-2000**



Ref. **16-EF-55084**

8 terminales redondos Ø 8,4 mm.
Sección de 2,5 a 6,0 mm².



Ref. **17-EF-15043-A**

20 terminales horquilla Ø 4,3 mm.
Sección de 0,5 a 1,5 mm².



Ref. **18-EF-15053-A**

18 terminales horquilla Ø 5,3 mm.
Sección de 0,5 a 1,5 mm².



Ref. **19-EF-25043-A**

18 terminales horquilla Ø 4,3 mm.
Sección de 1,0 a 2,5 mm².



Ref. **20-EF-25053-A**

18 terminales horquilla Ø 5,3 mm.
Sección de 1,0 a 2,5 mm².



Ref. **21-EF-55043-A**

12 terminales horquilla Ø 4,3 mm.
Sección de 2,5 a 6,0 mm².



Blisters para expositores

Refs. **01-EF-15019** a **25-EF-25635**: para **EXPOBRIC-2000**



Ref. **22-EF-55053-A**

12 terminales horquilla Ø 5,3 mm.
Sección de 2,5 a 6,0 mm².



Ref. **23-EF-55064-A**

8 terminales horquilla Ø 6,4 mm.
Sección de 2,5 a 6,0 mm².



Ref. **24-EF-25063**

20 terminales hembra enchufables 6,35.
Sección de 1,0 a 2,5 mm².



Ref. **25-EF-25635**

20 terminales macho enchufables 6,35 mm.
Sección de 1,0 a 2,5 mm².



Ref. **26-PVC-15019**

6 terminales puntera.
Sección de 0,5 a 1,5 mm².



Ref. **27-PVC-25019**

6 terminales puntera.
Sección de 1,5 a 2,5 mm².



Blisters para expositores

Refs. **26-PVC-15019** a **50-131019-NG**: para **EXPOHOBBY-2000**



Ref. 28-PVC-55027
4 terminales puntera.
Sección de 2,5 a 6,0 mm².



Ref. 29-PVC-15017
6 terminales empalme.
Sección de 0,5 a 1,5 mm².



Ref. 30-PVC-25023
6 terminales empalme.
Sección de 1,0 a 2,5 mm².



Ref. 31-PVC-55034
4 terminales empalme.
Sección de 2,5 a 6,0 mm².



Ref. 32-PVC-15043
6 terminales redondo Ø 4,3 mm.
Sección de 0,5 a 1,5 mm².



Ref. 33-PVC-25043
6 terminales redondo Ø 4,3 mm.
Sección de 1,0 a 2,5 mm².

10 Estuches - Expositores - Blisters



Blisters para expositores

Refs. **26-PVC-15019** a **50-131019-NG**: para **EXPOHOBBY-2000**



Ref. **34-PVC-55043**

4 terminales redondo Ø 4,3 mm.
Sección de 2,5 a 6,0 mm².



Ref. **35-PVC-15043-A**

6 terminales horquilla Ø 4,3 mm.
Sección de 0,5 a 1,5 mm².



Ref. **36-PVC-25043-A**

6 terminales horquilla Ø 4,3 mm.
Sección de 1,0 a 2,5 mm².



Ref. **37-PVC-55043-A**

4 terminales horquilla Ø 4,3 mm.
Sección de 2,5 a 6,0 mm².



Ref. **38-PVCC-15063**

6 terminales enchufable hembra 6,35 mm.
Sección de 0,5 a 1,5 mm².



Ref. **39-PVCC-25063**

6 terminales enchufable hembra 6,35 mm.
Sección de 1,0 a 2,5 mm².



Blisters para expositores

Refs. **26-PVC-15019** a **50-131019-NG**: para **EXPOHOBBY-2000**



Ref. **40-PVCC-55063**

4 terminales enchufable hembra 6,35 mm.
Sección de 2,5 a 6,0 mm².



Ref. **41-EFCC-15063-2**

6 terminales enchufable hembra 6,35 mm.
Sección de 0,5 a 1,5 mm².



Ref. **42-EFCC-25063-2**

6 terminales enchufable hembra 6,35 mm.
Sección de 1,0 a 2,5 mm².



Ref. **43-EFCC-55063-2**

4 terminales enchufable hembra 6,35 mm.
Sección de 2,5 a 6,0 mm².



Ref. **44-PVCC-15635**

6 terminales enchufable macho 6,35 mm.
Sección de 0,5 a 1,5 mm².



Ref. **45-PVCC-25635**

6 terminales enchufable macho 6,35mm.
Sección de 1,0 a 2,5 mm².



Blisters para expositores

Refs. **26-PVC-15019** a **50-131019-NG**: para **EXPOHOBBY-2000**



Ref. **46-PVCC-55635**

4 terminales enchufable macho 6,35 mm.
Sección de 2,5 a 6,0 mm².



Ref. **47-CR-100**

4 conectores rápidos.
Sección de 0,25 a 1,65 mm².



Ref. **48-CR-250**

4 conectores rápidos.
Sección de 1,04 a 2,63 mm².



Ref. **49-CR-600**

2 conectores rápidos.
Sección de 2,63 a 6,64 mm².



Ref. **50-131019-NG**

1 rollo de cinta aislante adhesiva
de 10 metros x 19 mm.



Ref. **51-14408-00**

40 terminales hembra de 2,8 x 0,5 mm.
Sección de 0,5 a 1,0 mm².

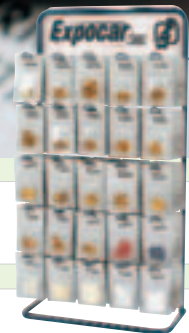

Blisters para expositores

Refs. **51-14408-00** a **75-PH-1020**: para **EXPOCAR-2000**



Ref. **52-14412-00**

25 terminales hembra de 4,8 x 0,5 mm.
Sección de 0,5 a 1,0 mm².



Ref. **53-14648-00**

35 terminales hembra de 6,3 x 0,8 mm.
Sección de 1,0 a 2,5 mm².



Ref. **54-14308-00**

40 terminales hembra de 2,8 x 0,5 mm.
Sección de 0,5 a 1,0 mm².



Ref. **55-14370-00**

20 terminales hembra de 5,0 x 0,8 mm.
Sección de 1,0 a 2,5 mm².



Ref. **56-14327-00**

20 terminales hembra de 6,3 x 0,8 mm.
Sección de 1,0 a 2,5 mm².



Ref. **57-15060-00**

30 terminales macho de 2,8 x 0,5 mm.
Sección de 0,5 a 1,0 mm².

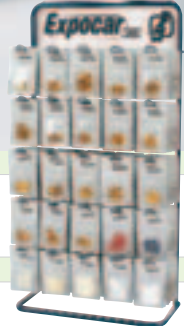

Blisters para expositores

Refs. **51-14408-00** a **75-PH-1020**: para **EXPOCAR-2000**



Ref. **58-16413-00**

20 terminales macho de 4,8 x 0,5 mm.
Sección de 0,5 a 1,0 mm².



Ref. **59-16422-00**

20 terminales macho de 6,3 x 0,8 mm.
Sección de 1,0 a 2,5 mm².



Ref. **60-16466-00**

20 terminales macho de 5,0 x 0,8 mm.
Sección de 1,0 a 2,5 mm².



Ref. **61-16432-00**

20 terminales macho de 6,3 x 0,8.
Sección de 1,0 a 2,5 mm².



Ref. **62-13437-00**

25 terminales redondos de Ø 4,2 mm²
Sección de 0,5 a 1,0 mm².



Ref. **63-13374-00**

25 terminales redondos de Ø 5,2 mm²
Sección de 0,75 a 2,0 mm².

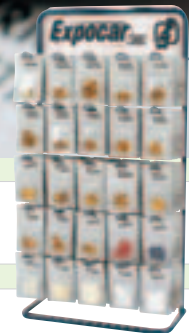

Blisters para expositores

Refs. **51-14408-00** a **75-PH-1020**: para **EXPOCAR-2000**



Ref. 64-13378-00
25 terminales redondos de Ø 6,2 mm²
Sección de 0,75 a 2,0 mm².



Ref. 65-13310-00
10 terminales redondos de Ø 8,5 mm²
Sección de 1,0 a 2,5 mm².



Ref. 66-13840-00
25 terminales horquilla de Ø 4,2 mm²
Sección de 0,5 a 1,0 mm².



Ref. 67-15222-00
10 terminales mixto macho-hembra
de 6,3 x 0,8 mm².
Sección de 0,75 a 1,5 mm².



Ref. 68-3838-6-00
10 terminales mixto macho-hembra
de 6,3 x 0,8 mm². Enchufable.



Ref. 69-CR-100
6 conectores rápidos.
Sección de 0,25 a 1,65 mm².

10 Estuches - Expositores - Blisters

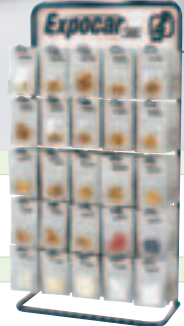

Blisters para expositores

Refs. 51-14408-00 a 75-PH-1020: para EXPOCAR-2000



Ref. **70-CR-250**

6 conectores rápidos.
Sección de 1,04 a 2,63 mm².



Ref. **71-CS-28N002**

30 protectores frontales hembra de 2,8 mm.



Ref. **72-CS-48N002**

30 protectores frontales hembra de 4,8 mm.



Ref. **73-CS-63N004-02**

25 protectores frontales hembra de 6,3 mm.



Ref. **74-PM-1080**

20 protectores para macho de 6,3 mm.



Ref. **75-PH-1020**

35 protectores para hembra de 6,3 mm.

10 Estuches - Expositores - Blisters

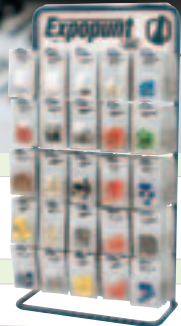

Blisters para expositores

Refs. **76-TE-0,14** a **100-DUO-2x16,00**: para **EXPOPUNT-2000**



Ref. 76-TE-0.14
100 punteras TE.
Sección de 0,14 mm².



Ref. 77-TE-0.25
100 punteras TE.
Sección de 0,25 mm².



Ref. 78-TE-0.34
100 punteras TE.
Sección de 0,34 mm².



Ref. 79-TE-0.50
100 punteras TE.
Sección de 0,50 mm².



Ref. 80-TE-0.75
100 punteras TE.
Sección de 0,75 mm².



Ref. 81-TE-1.00
100 punteras TE.
Sección de 1,00 mm².

10 Estuches - Expositores - Blisters



Blisters para expositores

Refs. **76-TE-0,14** a **100-DUO-2x16,00**: para **EXPOPUNT-2000**

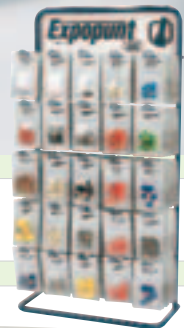

Ref. **82-TE-1.50**

100 punteras TE.
Sección de 1,50 mm².



Ref. **83-TE-2.50**

100 punteras TE.
Sección de 2,50 mm².



Ref. **84-TE-4.00**

100 punteras TE.
Sección de 4,00 mm².



Ref. **85-TE-6.00**

50 punteras TE.
Sección de 6,00 mm².



Ref. **86-TE-10.00**

50 punteras TE.
Sección de 10,00 mm².



Ref. **87-TE-16.00**

25 punteras TE.
Sección de 16,00 mm².

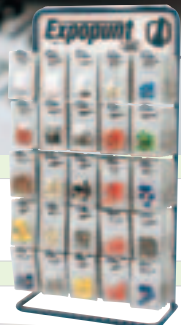

Blisters para expositores

Refs. **76-TE-0,14** a **100-DUO-2x16,00**: para **EXPOPUNT-2000**



Ref. 88-TE-25.00

15 punteras TE.
Sección de 25,00 mm².



Ref. 89-TE-35.00

10 punteras TE.
Sección de 35,00 mm².



Ref. 90-TE-50.00

5 punteras TE.
Sección de 50,00 mm².



Ref. 91-TE-70.00

5 punteras TE.
Sección de 70,00 mm².



Ref. 92-DUO-2x0.50

100 punteras DUO.
Sección de 0,50 mm².



Ref. 93-DUO-2x0.75

100 punteras DUO.
Sección de 0,75 mm².



Blisters para expositores

Refs. **76-TE-0,14** a **100-DUO-2x16,00**: para **EXPOPUNT-2000**



Ref. **94-DUO-2x1.00**

100 punteras DUO.
Sección de 1,00 mm².



Ref. **95-DUO-2x1.50**

100 punteras DUO.
Sección de 1,50 mm².



Ref. **96-DUO-2x2.50**

50 punteras DUO.
Sección de 2,50 mm².



Ref. **97-DUO-2x4.00**

25 punteras DUO.
Sección de 4,00 mm².



Ref. **98-DUO-2x6.00**

25 punteras DUO.
Sección de 6,00 mm².



Ref. **99-DUO-2x10.00**

10 punteras DUO.
Sección de 10,00 mm².

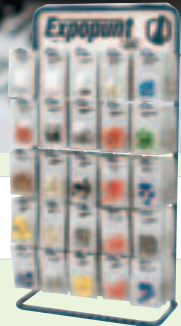

Blisters para expositores

Refs. **76-TE-0,14** a **100-DUO-2x16,00**: para **EXPOPUNT-2000**



Ref. **100-DUO-2x16.00**

5 punteras DUO.
Sección de 16,00 mm².



Blisters electro-auto

Refs. **XB-500** a **XB-524**: para **EXPOAUTO-2000**



Ref. **XB-500** - 1 fusible de cada

03.45.02-0	03.45.10-0
03.45.03-0	03.45.15-0
03.45.04-0	03.45.20-0
03.45.05-0	03.45.25-0
03.45.075-0	03.45.30-0



Ref. **XB-501** - 1 fusible de cada

03.40.03-0	03.40.15-0
03.40.04-0	03.40.20-0
03.40.05-0	03.40.25-0
03.40.075-0	03.40.30-0
03.40.10-0	03.26.0200-1



Ref. **XB-502** - 1 fusible de cada

03.50.30-0
03.50.40-0



Blisters electro-auto

Refs. **XB-500** a **XB-524**: para **EXPOAUTO-2000**



Ref. **XB-503** - 1 fusible de cada

03.50.50-0
03.50.60-0



Ref. **XB-504** - 2 fusibles de cada

03.30.05-0
03.30.08-0
03.30.16-0
03.30.25-0
03.26.0200-1



Ref. **XB-505**

2 portafusibles 03.135-0
1 fusible 03.40.10-0
1 fusible 03.40.15-0



Ref. **XB-506**

2 portafusibles 03.104-0
1 fusible 03.30.08-0
1 fusible 03.30.16-0



Ref. **XB-507**

2 portafusibles 03.105-0
1 fusible 03.30.08-0
1 fusible 03.30.16-0



Ref. **XB-508**

2 portafusibles 03.102-0
1 fusible 03.26.0200-1
1 fusible 03.26.0400-1



Blisters electro-auto

Refs. **XB-500** a **XB-524**: para **EXPOAUTO-2000**



Ref. **XB-509**

- 1 conector 12.2100
- 1 conector 12.3100
- 1 terminal 14327-00
- 1 terminal 16432-00



Ref. **XB-510**

- 1 conector 12.2101
- 1 conector 12.3101
- 2 terminales 14327-00
- 2 terminales 16432-00



Ref. **XB-511**

- 1 conector 12.2109
- 1 conector 12.3109
- 2 terminales 14327-00
- 2 terminales 16432-00



Ref. **XB-512**

- 1 conector 12.2102
- 1 conector 12.3102
- 3 terminales 14327-00
- 3 terminales 16432-00



Ref. **XB-513**

- 1 conector 12.2103
- 1 conector 12.3103
- 4 terminales 14327-00
- 4 terminales 16432-00



Ref. **XB-514**

- 1 conector 12.2104
- 1 conector 12.3104
- 6 terminales 14327-00
- 6 terminales 16432-00

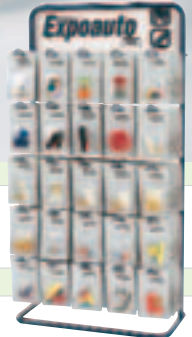

Blisters electro-auto

Refs. **XB-500** a **XB-524**: para **EXPOAUTO-2000**



Ref. **XB-515**

- 1 conector 12.2108
- 1 conector 12.3108
- 8 terminales 14327-00
- 8 terminales 16432-00



Ref. **XB-516** - 2 terminales de cada

- EFCC-15063
- EFCC-15635
- EFCC-25063
- EFCC-25635



Ref. **XB-517** - 2 terminales de cada

- EFCC-15063-2
- EFCC-25063-2
- EFCC-15635
- EFCC-25635



Ref. **XB-518** - 2 terminales de cada

- EFCC-15039
- EFCC-25039
- EFCC-15040-1
- EFCC-25040-1



Ref. **XB-519** - 2 terminales de cada

- EFCC-25049
- EFCC-55039
- EFCC-25050
- EFCC-55040



Ref. **XB-520** - 2 terminales de cada

- PVCC-15028
- PVCC-25048
- PVCC-15628
- PVCC-25480
- PVCC-25063
- PVCC-25635

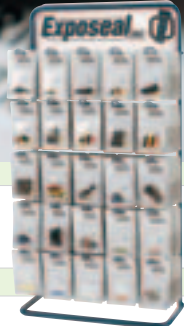

Blisters electro-auto

Refs. **XB-525** a **XB-549**: para **EXPOSEAL-2000**



Ref. **XB-521** - 2 conectores de cada

CR-100
CR-250
CR-600



Ref. **XB-522**

1 conector de cada:
CR-951 / CR-952 / CR-953
1 terminal de cada:
EF-15635-3 / EF-25635-3 / EF-55635-3



Ref. **XB-523** - 1 de cada

DEF-15039
DEF-15040-1
DEF-15063
DEF-15635



Ref. **XB-524**

6 terminales 14648-00
6 terminales 16422-00
6 protecciones PH-1026
6 protecciones PM-1086



Ref. **XB-525-M**

1 conector macho 44.23610
1 terminal macho 11.05550
1 seal silicona 44.07740



Ref. **XB-526-F**

1 conector hembra 44.23620
1 terminal hembra 11.05560
1 seal silicona 44.07740

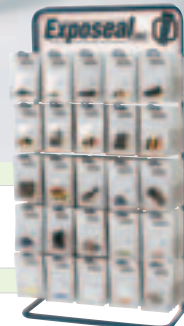

Blisters electro-auto

Refs. **XB-525** a **XB-549**: para **EXPOSEAL-2000**



Ref. **XB-527-M**

- 1 conector macho 44.23630
- 2 terminales macho 11.05550
- 2 seal silicona 44.07740



Ref. **XB-528-F**

- 1 conector hembra 44.23640
- 2 terminales hembra 11.05560
- 2 seal silicona 44.07740



Ref. **XB-529-M**

- 1 conector macho 44.23650
- 3 terminales macho 11.05550
- 3 seal silicona 44.07740



Ref. **XB-530-F**

- 1 conector hembra 44.23660
- 3 terminales hembra 11.05560
- 3 seal silicona 44.07740



Ref. **XB-531-M**

- 1 conector macho 44.23670
- 4 terminales macho 11.05550
- 4 seal silicona 44.07740



Ref. **XB-532-F**

- 1 conector hembra 44.23680
- 4 terminales hembra 11.05560
- 4 seal silicona 44.07740



Blisters electro-auto

Refs. **XB-525** a **XB-549**: para **EXPOSEAL-2000**

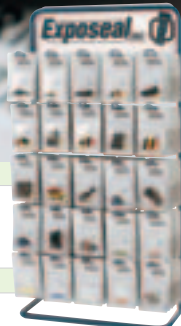

Ref. **XB-533-M**

1 conector macho 44.23690
5 terminales macho 11.05550
5 seal silicona 44.07740



Ref. **XB-534-F**

1 conector hembra 44.23700
5 terminales hembra 11.05560
5 seal silicona 44.07740



Ref. **XB-535-M**

1 conector macho 44.23710
6 terminales macho 11.05550
6 seal silicona 44.07740



Ref. **XB-536-F**

1 conector hembra 44.23720
6 terminales hembra 11.05560
6 seal silicona 44.07740



Ref. **XB-537-M**

1 conector macho 44.23520
1 terminal macho 11.04500-32
1 seal silicona 44.10662



Ref. **XB-538-F**

1 conector hembra 44.23510
1 terminal hembra 11.04510-32
1 seal silicona 44.10662



Blisters electro-auto

Refs. **XB-525** a **XB-549**: para **EXPOSEAL-2000**

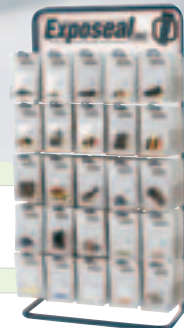

Ref. **XB-539-M**

- 1 conector macho 44.23540
- 2 terminales macho 11.04500-32
- 2 seal silicona 44.10662



Ref. **XB-540-F**

- 1 conector hembra 44.23530
- 2 terminales hembra 11.04510-32
- 2 seal silicona 44.10662



Ref. **XB-541-M**

- 1 conector macho 44.23560
- 3 terminales macho 11.04500-32
- 3 seal silicona 44.10662



Ref. **XB-542-F**

- 1 conector hembra 44.23550
- 3 terminales hembra 11.04510-32
- 3 seal silicona 44.10662



Ref. **XB-543**

- 6 seal silicona 44.07510
- Serie 2,8.
- Sección: 0,5 a 1,5 mm².



Ref. **XB-544**

- 6 seal silicona 44.07530
- Serie 1,5.
- Sección: 0,5 a 1,5 mm².



Blisters electro-auto

Refs. **XB-525** a **XB-549**: para **EXPOSEAL-2000**



Ref. **XB-545**

6 seal silicona 44.07740
Serie 1,5.
Sección: 0,5 a 1,5 mm².



Ref. **XB-546**

6 seal silicona 44.10662
Sección: 0,5 a 1,5 mm².



Ref. **XB-547**

6 seal silicona 44.10658
Sección: 1,5 a 2,5 mm².



Ref. **XB-548**

6 seal silicona 44.10659
Tapón de cierre.



Ref. **XB-549**

6 KIT completo.



Bolsas para exposidores

Refs. **B-CV-075** a **B-CH-8**: para **AUTODIS-2000**



Ref. **B-CV-075**

Bolsa de 25 bridas sujetacables de 75 x 2,4 mm. Color: natural



Ref. **B-CV-075B**

Bolsa de 25 bridas sujetacables de 75 x 2,4 mm. Color: negro

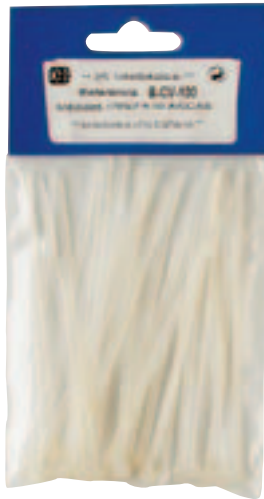

Ref. **B-CV-100**

Bolsa de 25 bridas sujetacables de 100 x 2,5 mm. Color: natural



Ref. **B-CV-100B**

Bolsa de 25 bridas sujetacables de 100 x 2,5 mm. Color: negro



Ref. **B-CV-140**

Bolsa de 25 bridas sujetacables de 142 x 3,2 mm. Color: natural



Ref. **B-CV-140B**

Bolsa de 25 bridas sujetacables de 142 x 3,2 mm. Color: negro



Ref. **B-CV-200**

Bolsa de 25 bridas sujetacables de 203 x 4,6 mm. Color: natural



Ref. **B-CV-200B**

Bolsa de 25 bridas sujetacables de 203 x 4,6 mm. Color: negro



Bolsas para expositores

Refs. **B-CV-075** a **B-CH-8**: para **AUTODIS-2000**



Ref. **B-CV-250**

Bolsa de 25 bridas sujetacables de 250 x 4,8 mm. Color: natural

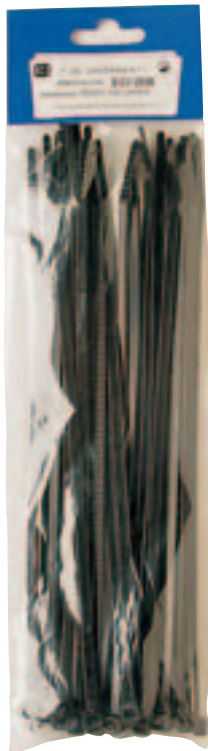

Ref. **B-CV-250B**

Bolsa de 25 bridas sujetacables de 250 x 4,8 mm. Color: negro



Ref. **B-CV-310**

Bolsa de 25 bridas sujetacables de 310 x 4,8 mm. Color: natural



Ref. **B-CV-310B**

Bolsa de 25 bridas sujetacables de 310 x 4,8 mm. Color: negro



Ref. **B-HC-1**

Bolsa de 10 bases de fijación por tornillo para bridas.



Ref. **B-HC-101**

Bolsa de 10 bases de fijación adhesiva para bridas.



Ref. **B-CH-8**

Bolsa de 10 tacos a presión para soporte de bridas.



Bolsas para expositores

Refs. **VP-50-48N** a **VP-150-4811C**: para **BRICOLOR-2000**



Ref. **VP-50-48N**

50 bridas de 100 x 2,5 mm.
y 203 x 3,2 mm. Color: natural



Ref. **VP-50-48BK**

50 bridas de 100 x 2,5 mm.
y 203 x 3,2 mm. Color: negro



Ref. **VP-50-48Y**

50 bridas de 100 x 2,5 mm.
y 203 x 3,2 mm. Color: amarillo



Ref. **VP-50-48R**

50 bridas de 100 x 2,5 mm.
y 203 x 3,2 mm. Color: rojo



Ref. **VP-50-48C**

50 bridas de 100 x 2,5 mm.
y 203 x 3,2 mm.
Surtido de: negro, rojo,
 amarillo, azul



Ref. **VP-50-8BK**

50 bridas de 203 x 3,2 mm.
Color: negro



Ref. **VP-50-4BK**

50 bridas de 100 x 2,5 mm.
Color: negro



Ref. **VP-50-4N**

50 bridas de 100 x 2,5 mm.
Color: natural



Bolsas para expositores

Refs. **VP-50-48N** a **VP-150-4811C**: para **BRICOLOR-2000**



Ref. **VP-50-11N**

50 bridas de 280 x 5,0 mm.
Color: natural



Ref. **VP-50-11BK**

50 bridas de 280 x 5,0 mm.
Color: negro



Ref. **VP-50-811N**

50 bridas de 203 x 3,2 mm.
y 280 x 5,0 mm. Color: natural



Ref. **VP-50-811BK**

50 bridas de 203 x 3,2 mm.
y 280 x 5,0 mm. Color: negro



Ref. **VP-50-811Y**

50 bridas de 203 x 3,2 mm.
y 280 x 5,0 mm.
Color: amarillo



Ref. **VP-50-811BL**

50 bridas de 203 x 3,2 mm.
y 280 x 5,0 mm.
Color: azul



Ref. **VP-50-811R**

50 bridas de 203 x 3,2 mm.
y 280 x 5,0 mm.
Color: rojo



Ref. **VP-50-4811C**

50 bridas de 100 x 2,5 mm.,
203 x 3,2 mm. y 280 x 5,0 mm.
Surtido de: negro, rojo,
 amarillo, azul



Bolsas para exposidores

Refs. **VP-50-48N** a **VP-150-4811C**: para **BRICOLOR-2000**



Ref. **VP-50-811C**

50 bridas de 203 x 3,2 mm. y 280 x 5,0 mm.

Surtido de: ■ negro, ■ rojo, ■ amarillo, ■ azul



Ref. **VP-150-4811C**

150 bridas de 100 x 2,5 mm., 203 x 3,2 mm. y 280 x 5,0 mm.

Surtido de: ■ negro, ■ rojo, ■ amarillo, ■ azul, □ natural



Ref. **PB-100-4NA**

Contenido: 100 bridas CV-100

Color: □ natural



Ref. **PB-100-4BK**

Contenido: 100 bridas CV-100B

Color: ■ negro

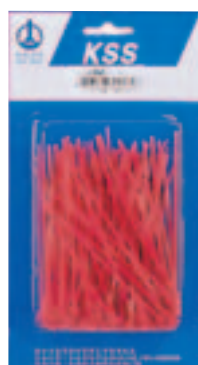

Ref. **PB-100-4RD**

Contenido: 100 bridas CV-100-6

Color: ■ rojo



Ref. **PB-100-4BE**

Contenido: 100 bridas CV-100-3

Color: ■ azul

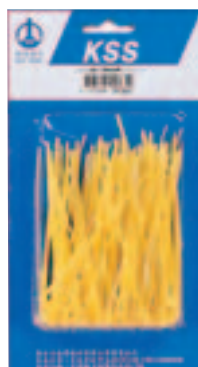

Ref. **PB-100-4YW**

Contenido: 100 bridas CV-100-2

Color: ■ amarillo



Ref. **PB-100-4GN**

Contenido: 100 bridas CV-100-8

Color: ■ verde



Bolsas para exposidores



Ref. **PB-100-4RD/YW**

Contenido: 50 bridas CV-100-2
50 bridas CV-100-6
Colores: ■ rojo, ■ amarillo



Ref. **PB-100-4RD/GN**

Contenido: 50 bridas CV-100-8
50 bridas CV-100-6
Colores: ■ verde, ■ rojo



Ref. **PB-100-8NA**

Contenido:
100 bridas CV-200A



Ref. **PB-100-10NA**

Contenido:
100 bridas CV-250



Ref. **PB-100-4RD/BK**

Contenido: 50 bridas CV-100-8
50 bridas CV-100B
Colores: ■ rojo, ■ negro

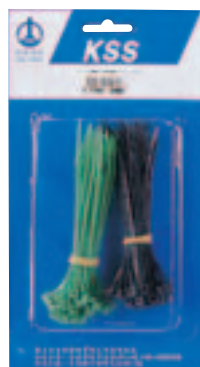

Ref. **PB-100-4GN/BK**

Contenido: 50 bridas CV-100-8
50 bridas CV-100B
Colores: ■ verde, ■ negro



Ref. **PB-100-4YW/BK**

Contenido: 50 bridas CV-100-2
50 bridas CV-100B
Colores: ■ amarillo, ■ negro



Blisters electro-industria



Ref. **DB-25-SW**

Conectores ciegos a rosca con muelle interior.

Composición:

10 piezas SW-73B Color: ■ naranja

10 piezas SW-74B Color: ■ amarillo

10 piezas SW-76B Color: ■ rojo



Ref. **DB-25-73B**

Conectores ciegos a rosca con muelle interior.

Composición: 25 piezas SW-73B

Color: ■ naranja



Ref. **DB-20-74B**

Conectores ciegos a rosca con muelle interior.

Composición: 20 piezas SW-74B

Color: ■ amarillo



Tubo termo-retráctil de poliolefina XBPT-125°C. Contracción 2:1 HOMOLOGADO
En bolsas para expositor

Homologaciones:   



Ref.	Largo pieza cm.	Nº de piezas por bolsa	Ø antes de contraer mm.	
XBPT-1.2-20NG	20	20	1,2	10/50
XBPT-1.2-20RO	20	20	1,2	10/50
XBPT-1.6-20NG	20	20	1,6	10/50
XBPT-1.6-20RO	20	20	1,6	10/50
XBPT-2.4-20NG	20	20	2,4	10/50
XBPT-2.4-20RO	20	20	2,4	10/50
XBPT-3.2-20NG	20	20	3,2	10/50
XBPT-3.2-20RO	20	20	3,2	10/50
XBPT-4.8-20NG	20	20	4,8	10/50
XBPT-4.8-20RO	20	20	4,8	10/50
XBPT-6.4-20NG	20	10	6,4	10/50
XBPT-6.4-20RO	20	10	6,4	10/50
XBPT-9.5-20NG	20	10	9,5	10/50
XBPT-9.5-20RO	20	10	9,5	10/50
XBPT-12.7-20NG	20	10	12,7	10/50
XBPT-12.7-20RO	20	10	12,7	10/50
XBPT-19.0-20NG	20	5	19,0	10/50
XBPT-19.0-20RO	20	5	19,0	10/50
XBPT-25.4-20NG	20	5	25,4	10/50
XBPT-25.4-20RO	20	5	25,4	10/50