

VI CATALOGO GENERAL VI GRUPO 5 VI (1.04.05) VI

BRIDAS Y OTRAS MATERIAS PLASTICAS



BRIDAS Y OTRAS

\\ CÁTALOGO GENERAL \\ GRUPO5 \\ V.04.05 \\



Bridas sujetacables de nylon diversas5-6 a 5-20



Bridas sujetacables metálicas diversas5-20 a 5-22



Tubos, bandas, cintas y cordón para revestimiento, sujeción y atado de cables5-23 a 5-25



Grapas, bases, tacos, abrazaderas y clips para soporte y sujeción de cables5-28 a 5-38



Prensaestopas, adaptadores, protectores y tubos flexibles y metálicos empotrables5-40 a 5-49



Pasacables, cubrearistas, tapa orificios y tapas protectoras5-52 a 5-58



Grapas y tacos para cables redondos y telefónicos con clavo5-61 a 5-64



Soportes, mini soportes, guías, distanciadores, remaches y tapa orificios para circuitos impresos5-66 a 5-76

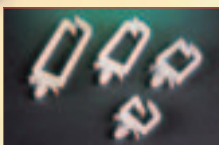

Abrazaderas, clips, bridas, protectores, porta leds, tornillos y arandelas de plástico para circuitos impresos5-78 a 5-92



Canaletas y sus accesorios5-94 a 5-109

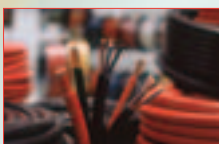

Cables y expositores Delico5-113 a 5-116

MATERIAS PLÁSTICAS



Regletas de conexión, bornas, terminales de derivación y sus accesorios5-118 a 5-153



Boxline, conjuntos repartidores, tetrapolares, conectores de derivación y otros5-156 a 5-160



Xbflex, tubos trenzados, tubos expandibles de poliéster, poliamida, fibra de vidrio y otros.....5-162 a 5-168



Tubos termo-retractiles, cajas dosificadoras y su expositor.....5-170 a 5-179



Cintas helicoidales, fundaflex, cristalflex, gomaflex, flexair, azulflex, vulcaflex y rubiflex5-179 a 5-183



Cintas electro-aislantes adhesivas.....5-186 a 5-189



Guías pasacables y sus accesorios5-192 a 5-198



Pinzas "tipo cocodrilo" y sus fundas protectoras5-199



Pilotos Led con resistencia incorporada.....5-200



Bolsas de plástico de cierre hermético5-201

BRIDAS Y OTRAS MATERIAS PLASTICAS

Nuestro nuevo catálogo número cinco, por su diversidad, es nuestra gran apuesta de futuro. Grandes grupos de producto: Bridas y sus accesorios, prensa-estopas, canaletas y sus accesorios, cables, tubos termo-retractiles, cintas, regletas, guías pasacables y otros, lo convierten en imprescindible para los sectores eléctrico, auto eléctrico y electrónico. Sus más de 200 páginas hacen imprescindible el uso de los índices fotográfico y alfanumérico. Agradeceremos de vuestra parte, estimados clientes, una lectura pausada del mismo, ya que en él podréis encontrar muchos artículos esperados y nuevos que podrán resultar de gran utilidad. Como siempre, calidad, servicio y competitividad. Gracias por vuestra confianza.

For its diversity, our catalogue number five is our commitment to the future. Major product groups: Flanges and accessories, stuffing boxes, trunking and accessories, cables, thermo-retractable tubing, tapes, strips, cable sleeves, etc., make this catalogue an indispensable reference work for the electrical, auto-electric and electronics industries. With more than 200 pages, photographic and alphanumeric indexes enable products to be found quickly and easily. We ask you to carefully peruse our catalogue as it contains many new products that you have been waiting for and which you may find particularly useful. As always, quality, service and competitive prices. Thank you for your custom.

En raison de sa diversité, notre nouveau catalogue numéro cinq constitue notre grand pari pour l'avenir. De grands groupes de produit : les brides et leurs accessoires, les presse-étoupe, les goulottes et leurs accessoires, les câbles, les tuyaux thermorétractables, les bandes, les réglettes, les guides-câbles et beaucoup d'autres, en font un catalogue indispensable pour les secteurs électrique, électricité auto et électronique. Ses plus de 200 pages font des tables de matières photographique et alphanumérique un élément indispensable. Nous vous serions reconnaissants, chers clients, de bien vouloir consulter ce catalogue en toute tranquillité, car vous pourrez y trouver de nombreux articles que vous connaissez déjà et de nouveaux qui vous seront d'une grande utilité. Comme toujours, notre slogan : qualité, service et compétitivité. Nous vous remercions de votre confiance.

El nostre nou catàleg número cinc, per la seva diversitat, és la nostra gran aposta de futur. Grans grups de producte: brides i els seus accessoris, premsaestopes, canaletes i els seus accessoris, cables, tubs termoretractils, cintes, pastilles de connexions, guies passacables i altres, el converteixen en imprescindible per als sectors elèctric, autoelèctric i electrònic. Les seves més de 200 pàgines fan imprescindible l'ús dels índexs fotogràfic i alfanumèric. Agraïem per la vostra part, estimats clients, una lectura pausada del catàleg, ja que hi podreu trobar molts articles esperats i nous que us podran resultar de gran utilitat. Com sempre, qualitat, servei i competitivitat. Gràcies per la vostra confiança.

Xavier Bosch i Alsina
President





BRIDAS
SUJETACABLES



BRIDAS SUJETACABLES DE NYLON

Homologaciones: E 97527 E-4988 14515-99HH

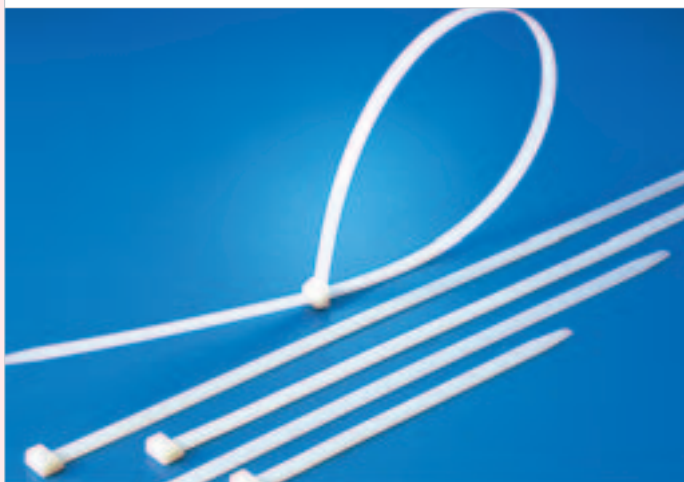

Material: Nylon 66 homologado 94 V-2
Temperatura de utilización: - 40 °C a + 85 °C
Ratio de flamabilidad: 94 V-2

Color: Natural, negro

Fabricadas para cumplir las especificaciones militares plano MS-3367.

La fuerza de tensión cumple o excede la norma ML-S-23190D.

Homologación E-97527 para todas las medidas y colores.

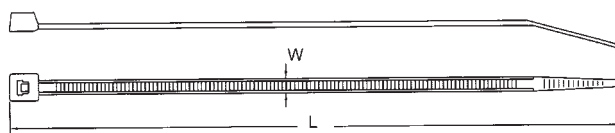

| Ref. 100 uds. | Ref. 1000 uds. | Ref. 100 uds. | Ref. 1000 uds. | Dimensiones L x W | Ø Máx. Uso mm. | Carga Kg |
|----------------------------------|-----------------------------------|--|---|----------------------|-------------------|----------|
| <input type="checkbox"/> CV-060 | <input type="checkbox"/> CV-060K | <input checked="" type="checkbox"/> CV-060B | <input checked="" type="checkbox"/> CV-060BK | 63.7 x 2.4 | 12 | 8 |
| <input type="checkbox"/> CV-075 | <input type="checkbox"/> CV-075K | <input checked="" type="checkbox"/> CV-075B | <input checked="" type="checkbox"/> CV-075BK | 75 x 2.4 | 18 | 8 |
| <input type="checkbox"/> CV-080 | <input type="checkbox"/> CV-080K | <input checked="" type="checkbox"/> CV-080B | <input checked="" type="checkbox"/> CV-080BK | 80 x 2.4 | 19 | 8 |
| <input type="checkbox"/> CV-094 | <input type="checkbox"/> CV-094K | <input checked="" type="checkbox"/> CV-094B | <input checked="" type="checkbox"/> CV-094BK | 96 x 2.5 | 23 | 8 |
| <input type="checkbox"/> CV-100 | <input type="checkbox"/> CV-100K | <input checked="" type="checkbox"/> CV-100B | <input checked="" type="checkbox"/> CV-100BK | 100 x 2.5 | 25 | 8 |
| <input type="checkbox"/> CV-120S | <input type="checkbox"/> CV-120SK | <input checked="" type="checkbox"/> CV-120SB | <input checked="" type="checkbox"/> CV-120SBK | 120 x 2.5 | 30 | 8 |
| <input type="checkbox"/> CV-140S | <input type="checkbox"/> CV-140SK | <input checked="" type="checkbox"/> CV-140SB | <input checked="" type="checkbox"/> CV-140SBK | 142 x 2.5 | 35 | 8 |
| <input type="checkbox"/> CV-150S | <input type="checkbox"/> CV-150SK | <input checked="" type="checkbox"/> CV-150SB | <input checked="" type="checkbox"/> CV-150SBK | 155 x 2.5 | 39 | 8 |
| <input type="checkbox"/> CV-165 | <input type="checkbox"/> CV-165K | <input checked="" type="checkbox"/> CV-165B | <input checked="" type="checkbox"/> CV-165BK | 165 x 2.5 | 44 | 8 |
| <input type="checkbox"/> CV-200M | <input type="checkbox"/> CV-200MK | <input checked="" type="checkbox"/> CV-200MB | <input checked="" type="checkbox"/> CV-200MBK | 203 x 2.5 | 55 | 8 |
| <input type="checkbox"/> CV-400S | | <input checked="" type="checkbox"/> CV-400SB | | 400 x 2.5 | 117 | 8 |
| <input type="checkbox"/> CV-120 | <input type="checkbox"/> CV-120K | <input checked="" type="checkbox"/> CV-120B | <input checked="" type="checkbox"/> CV-120BK | 120 x 3.2 | 30 | 18 |
| <input type="checkbox"/> CV-140 | <input type="checkbox"/> CV-140K | <input checked="" type="checkbox"/> CV-140B | <input checked="" type="checkbox"/> CV-140BK | 142 x 3.2 | 35 | 18 |
| <input type="checkbox"/> CV-200S | <input type="checkbox"/> CV-200SK | <input checked="" type="checkbox"/> CV-200SB | <input checked="" type="checkbox"/> CV-200SBK | 203 x 3.2 | 55 | 18 |
| <input type="checkbox"/> CV-150 | <input type="checkbox"/> CV-150K | <input checked="" type="checkbox"/> CV-150B | <input checked="" type="checkbox"/> CV-150BK | 150 x 3.6 | 39 | 18 |
| <input type="checkbox"/> CV-180 | <input type="checkbox"/> CV-180K | <input checked="" type="checkbox"/> CV-180B | <input checked="" type="checkbox"/> CV-180BK | 180 x 3.6 | 49 | 18 |
| <input type="checkbox"/> CV-200A | <input type="checkbox"/> CV-200AK | <input checked="" type="checkbox"/> CV-200AB | <input checked="" type="checkbox"/> CV-200ABK | 203 x 3.6 | 55 | 18 |
| <input type="checkbox"/> CV-250M | <input type="checkbox"/> CV-250MK | <input checked="" type="checkbox"/> CV-250MB | <input checked="" type="checkbox"/> CV-250MBK | 250 x 3.6 | 74 | 18 |
| <input type="checkbox"/> CV-265 | <input type="checkbox"/> CV-265K | <input checked="" type="checkbox"/> CV-265B | <input checked="" type="checkbox"/> CV-265BK | 265 x 3.6 | 78 | 18 |
| <input type="checkbox"/> CV-292 | <input type="checkbox"/> CV-292K | <input checked="" type="checkbox"/> CV-292B | <input checked="" type="checkbox"/> CV-292BK | 292 x 3.6 | 85 | 18 |
| <input type="checkbox"/> CV-330 | | <input checked="" type="checkbox"/> CV-330B | | 330 x 3.6 | 96 | 18 |
| <input type="checkbox"/> CV-368S | | <input checked="" type="checkbox"/> CV-368SB | | 368 x 3.6 | 102 | 18 |



BRIDAS SUJETACABLES DE NYLON

Homologaciones:  E 97527  E-4988  14515-99HH 

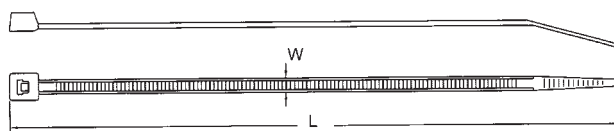

| Ref. 100 uds. | Ref. 1000 uds. | Ref. 100 uds. | Ref. 1000 uds. | Dimensiones L x W | Ø Máx. Uso mm. | Carga Kg |
|-----------------------------------|------------------------------------|---|--|----------------------|-------------------|----------|
| <input type="checkbox"/> CV-200 | <input type="checkbox"/> CV-200K | <input checked="" type="checkbox"/> CV-200B | <input checked="" type="checkbox"/> CV-200BK | 203 x 4.6 | 55 | 22 |
| <input type="checkbox"/> CV-120L | <input type="checkbox"/> CV-120LK | <input checked="" type="checkbox"/> CV-120LB | <input checked="" type="checkbox"/> CV-120LBK | 120 x 4.8 | 30 | 22 |
| <input type="checkbox"/> CV-160L | <input type="checkbox"/> CV-160LK | <input checked="" type="checkbox"/> CV-160LB | <input checked="" type="checkbox"/> CV-160LBK | 160 x 4.8 | 42 | 22 |
| <input type="checkbox"/> CV-190 | <input type="checkbox"/> CV-190K | <input checked="" type="checkbox"/> CV-190B | <input checked="" type="checkbox"/> CV-190BK | 190 x 4.8 | 52 | 22 |
| <input type="checkbox"/> CV-250 | <input type="checkbox"/> CV-250K | <input checked="" type="checkbox"/> CV-250B | <input checked="" type="checkbox"/> CV-250BK | 250 x 4.8 | 74 | 22 |
| <input type="checkbox"/> CV-280 | <input type="checkbox"/> CV-280K | <input checked="" type="checkbox"/> CV-280B | <input checked="" type="checkbox"/> CV-280BK | 280 x 4.8 | 81 | 22 |
| <input type="checkbox"/> CV-300S | | <input checked="" type="checkbox"/> CV-300SB | | 300 x 4.8 | 85 | 22 |
| <input type="checkbox"/> CV-310 | | <input checked="" type="checkbox"/> CV-310B | | 310 x 4.8 | 89 | 22 |
| <input type="checkbox"/> CV-368 | | <input checked="" type="checkbox"/> CV-368B | | 368 x 4.8 | 102 | 22 |
| <input type="checkbox"/> CV-385 | | <input checked="" type="checkbox"/> CV-385B | | 385 x 4.8 | 116 | 22 |
| <input type="checkbox"/> CV-432 | | <input checked="" type="checkbox"/> CV-432B | | 432 x 4.8 | 125 | 22 |
| <input type="checkbox"/> CV-450M | | <input checked="" type="checkbox"/> CV-450MB | | 450 x 4.8 | 130 | 22 |
| <input type="checkbox"/> CV-500 | | <input checked="" type="checkbox"/> CV-500B | | 500 x 4.8 | 150 | 22 |
| <input type="checkbox"/> CV-550S | | <input checked="" type="checkbox"/> CV-550SB | | 550 x 4.8 | 166 | 22 |
| <input type="checkbox"/> CV-914S | | <input checked="" type="checkbox"/> CV-914SB | | 914 x 4.8 | 270 | 22 |
| <input type="checkbox"/> CV-380S | | <input checked="" type="checkbox"/> CV-380SB | | 380 x 6.4 | 110 | 45 |
| <input type="checkbox"/> CV-120LL | <input type="checkbox"/> CV-120LLK | <input checked="" type="checkbox"/> CV-120LLB | <input checked="" type="checkbox"/> CV-120LLBK | 120 x 7.6 | 30 | 55 |
| <input type="checkbox"/> CV-150L | <input type="checkbox"/> CV-150LK | <input checked="" type="checkbox"/> CV-150LB | <input checked="" type="checkbox"/> CV-150LBK | 150 x 7.6 | 39 | 55 |
| <input type="checkbox"/> CV-200L | <input type="checkbox"/> CV-200LK | <input checked="" type="checkbox"/> CV-200LB | <input checked="" type="checkbox"/> CV-200LBK | 203 x 7.6 | 55 | 55 |
| <input type="checkbox"/> CV-240L | <input type="checkbox"/> CV-240LK | <input checked="" type="checkbox"/> CV-240LB | <input checked="" type="checkbox"/> CV-240LBK | 240 x 7.6 | 66 | 55 |
| <input type="checkbox"/> CV-280L | <input type="checkbox"/> CV-280LK | <input checked="" type="checkbox"/> CV-280LB | <input checked="" type="checkbox"/> CV-280LBK | 280 x 7.6 | 78 | 55 |
| <input type="checkbox"/> CV-300 | | <input checked="" type="checkbox"/> CV-300B | | 300 x 7.6 | 88 | 55 |
| <input type="checkbox"/> CV-340 | | <input checked="" type="checkbox"/> CV-340B | | 340 x 7.6 | 99 | 55 |
| <input type="checkbox"/> CV-380 | | <input checked="" type="checkbox"/> CV-380B | | 380 x 7.6 | 110 | 55 |
| <input type="checkbox"/> CV-450 | | <input checked="" type="checkbox"/> CV-450B | | 450 x 8.0 | 133 | 80 |
| <input type="checkbox"/> CV-500L | | <input checked="" type="checkbox"/> CV-550LB | | 500 x 8.0 | 150 | 80 |
| <input type="checkbox"/> CV-550 | | <input checked="" type="checkbox"/> CV-550B | | 550 x 8.0 | 166 | 80 |
| <input type="checkbox"/> CV-610 | | <input checked="" type="checkbox"/> CV-610B | | 610 x 9.0 | 185 | 80 |
| <input type="checkbox"/> CV-685 | | <input checked="" type="checkbox"/> CV-685B | | 685 x 9.0 | 210 | 80 |
| <input type="checkbox"/> CV-710 | | <input checked="" type="checkbox"/> CV-710B | | 710 x 9.0 | 220 | 80 |
| <input type="checkbox"/> CV-762 | | <input checked="" type="checkbox"/> CV-762B | | 762 x 9.0 | 236 | 80 |
| <input type="checkbox"/> CV-812 | | <input checked="" type="checkbox"/> CV-812B | | 812 x 9.0 | 246 | 80 |
| <input type="checkbox"/> CV-914 | | <input checked="" type="checkbox"/> CV-914B | | 914 x 9.0 | 270 | 80 |
| <input type="checkbox"/> CV-940 | | <input checked="" type="checkbox"/> CV-940B | | 950 x 9.0 | 285 | 80 |
| <input type="checkbox"/> CV-1168 | | <input checked="" type="checkbox"/> CV-1168B | | 1168 x 9.0 | 360 | 80 |
| <input type="checkbox"/> CV-1219 | | <input checked="" type="checkbox"/> CV-1219B | | 1219 x 9.0 | 380 | 80 |



BRIDAS SUJETACABLES DE NYLON EXTRA RESISTENTES

Homologaciones:  E 97527  E-4988  14515-99HH 

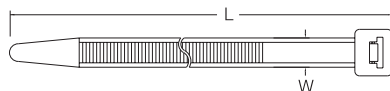

| Ref. 100 uds. | Ref. 1000 uds. | Ref. 100 uds. | Ref. 1000 uds. | Dimensiones L x W | Ø Máx. Uso mm. | Carga Kg |
|------------------------------------|-------------------|--|-------------------|----------------------|-------------------|----------|
| <input type="checkbox"/> CV-230XL | | <input checked="" type="checkbox"/> CV-230XLB | | 230 x 12.7 | 63 | 114 |
| <input type="checkbox"/> CV-280XL | | <input checked="" type="checkbox"/> CV-280XLB | | 280 x 12.7 | 80 | 114 |
| <input type="checkbox"/> CV-380XL | | <input checked="" type="checkbox"/> CV-380XLB | | 380 x 12.7 | 110 | 114 |
| <input type="checkbox"/> CV-480XL | | <input checked="" type="checkbox"/> CV-480XLB | | 480 x 12.7 | 140 | 114 |
| <input type="checkbox"/> CV-550XL | | <input checked="" type="checkbox"/> CV-550XLB | | 550 x 12.7 | 166 | 114 |
| <input type="checkbox"/> CV-580XL | | <input checked="" type="checkbox"/> CV-580XLB | | 580 x 12.7 | 175 | 114 |
| <input type="checkbox"/> CV-730XL | | <input checked="" type="checkbox"/> CV-730XLB | | 730 x 12.7 | 225 | 114 |
| <input type="checkbox"/> CV-880XL | | <input checked="" type="checkbox"/> CV-880XLB | | 880 x 12.7 | 267 | 114 |
| <input type="checkbox"/> CV-1030XL | | <input checked="" type="checkbox"/> CV-1030XLB | | 1030 x 12.7 | 317 | 114 |
| <input type="checkbox"/> CV-255XXL | | <input checked="" type="checkbox"/> CV-255XXLB | | 253 x 17.8 | 44 | 55 |

INFORMACIÓN PARA PEDIDOS:

| Material | Ref. | Sufijo | 1000 Uds./ Bolsa | Material | Ref. | Sufijo | 1000 Uds./ Bolsa |
|----------------------------|--------|--------|------------------------|-----------------------------------|--------|--------|------------------------|
| NYLON 66 (NATURAL) | CV-100 | -- | K | NYLON 66 (ALTA TEMPERATURA) | CV-100 | HS | K |
| NYLON 66 (NEGRO) | CV-100 | B | K | NYLON 66 (RETARDADOR DE LA LLAMA) | CV-100 | VO | K |
| NYLON 66 (PARA INTEMPERIE) | CV-100 | W | K | NYLON 12 | CV-100 | N12 | K |



BRIDAS SUJETACABLES DE NYLON DE COLORES

Homologaciones:  E 97527  E-4988  14515-99HH 

AMARILLO: -2

AZUL: -3

AMARILLO FLUOR: -4

GRIS: -5









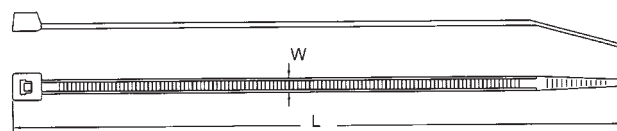



















ROJO: -6

NARANJA: -7

VERDE: -8

VIOLETA: -9



| Ref. | Dimensiones mm. L x W | Ø Máx Uso mm. | Carga Kg |  |
|---|--------------------------|------------------|----------|---|
|  CV-100-2 | 100 x 2.5 | 25 | 8 | 100 |
|  CV-100-3 | 100 x 2.5 | 25 | 8 | 100 |
|  CV-100-4 | 100 x 2.5 | 25 | 8 | 100 |
|  CV-100-5 | 100 x 2.5 | 25 | 8 | 100 |
|  CV-100-6 | 100 x 2.5 | 25 | 8 | 100 |
|  CV-100-7 | 100 x 2.5 | 25 | 8 | 100 |
|  CV-100-8 | 100 x 2.5 | 25 | 8 | 100 |
|  CV-100-9 | 100 x 2.5 | 25 | 8 | 100 |
|  CV-140S-2 | 142 x 2.5 | 35 | 8 | 100 |
|  CV-140S-3 | 142 x 2.5 | 35 | 8 | 100 |
|  CV-140S-6 | 142 x 2.5 | 35 | 8 | 100 |
|  CV-140S-8 | 142 x 2.5 | 35 | 8 | 100 |
|  CV-200S-2 | 203 x 3.2 | 55 | 18 | 100 |
|  CV-200S-3 | 203 x 3.2 | 55 | 18 | 100 |
|  CV-200S-6 | 203 x 3.2 | 55 | 18 | 100 |
|  CV-200S-8 | 203 x 3.2 | 55 | 18 | 100 |
|  CV-292-2 | 292 x 3.6 | 85 | 18 | 100 |
|  CV-292-3 | 292 x 3.6 | 85 | 18 | 100 |
|  CV-292-6 | 292 x 3.6 | 85 | 18 | 100 |
|  CV-292-8 | 203 x 3.6 | 85 | 18 | 100 |
|  CV-150-2 | 150 x 3.6 | 39 | 18 | 100 |
|  CV-150-3 | 150 x 3.6 | 39 | 18 | 100 |
|  CV-150-6 | 150 x 3.6 | 39 | 18 | 100 |
|  CV-150-8 | 150 x 3.6 | 39 | 18 | 100 |
|  CV-280-2 | 280 x 4.8 | 81 | 22 | 100 |
|  CV-280-3 | 280 x 4.8 | 81 | 22 | 100 |
|  CV-280-6 | 280 x 4.8 | 81 | 22 | 100 |
|  CV-280-8 | 280 x 4.8 | 81 | 22 | 100 |



Bridas de NYLON para intemperie

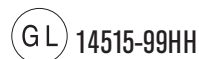

Bridas con protección
contra los rayos
ultravioleta



Nylon resistente
a la intemperie (UV):
Con carbonato A añadido para dar una
mayor resistencia contra los rayos UVA,
para usos exteriores.

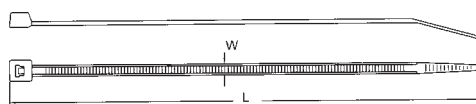

| Ref. 100 uds. | Ref. 1000 uds. | Dimensiones mm. | Ø Máx Uso mm. | Carga Kg | Ref. 100 uds. | Ref. 1000 uds. | Dimensiones mm. | Ø Máx Uso mm. | Carga Kg |
|------------------|-------------------|--------------------|------------------|-------------|------------------|-------------------|--------------------|------------------|-------------|
| CV-060W | CV-060KW | 63.7 x 2.4 | 12 | 8 | CV-368W | | 368 x 4.8 | 102 | 22 |
| CV-075W | CV-075KW | 75 x 2.4 | 18 | 8 | CV-385W | | 385 x 4.8 | 116 | 22 |
| CV-080W | CV-080KW | 80 x 2.4 | 19 | 8 | CV-432W | | 432 x 4.8 | 125 | 22 |
| CV-094W | CV-094KW | 96 x 2.5 | 23 | 8 | CV-450MW | | 450 x 4.8 | 130 | 22 |
| CV-100W | CV-100KW | 100 x 2.5 | 25 | 8 | CV-500W | | 500 x 4.8 | 150 | 22 |
| CV-120SW | CV-120SKW | 120 x 2.5 | 30 | 8 | CV-550SW | | 550 x 4.8 | 166 | 22 |
| CV-140SW | CV-140SKW | 142 x 2.5 | 35 | 8 | CV-914SW | | 914 x 4.8 | 270 | 22 |
| CV-150SW | CV-150SKW | 150 x 2.5 | 39 | 8 | CV-380SW | | 380 x 6.4 | 110 | 45 |
| CV-165W | CV-165KW | 165 x 2.5 | 44 | 8 | CV-120LLW | CV-120LLKW | 120 x 7.6 | 30 | 55 |
| CV-200MW | CV-200MKW | 203 x 2.5 | 55 | 8 | CV-150LW | CV-150LKW | 150 x 7.6 | 39 | 55 |
| CV-400SW | | 400 x 2.5 | 117 | 8 | CV-200LW | CV-200LKW | 203 x 7.6 | 55 | 55 |
| CV-120W | CV-120KW | 120 x 3.2 | 30 | 18 | CV-240LW | CV-240LKW | 240 x 7.6 | 66 | 55 |
| CV-140W | CV-140KW | 142 x 3.2 | 35 | 18 | CV-280LW | CV-280LKW | 280 x 7.6 | 78 | 55 |
| CV-200SW | CV-200SKW | 203 x 3.2 | 55 | 18 | CV-300W | | 300 x 7.6 | 88 | 55 |
| CV-150W | CV-150KW | 150 x 3.6 | 39 | 18 | CV-340W | | 340 x 7.6 | 99 | 55 |
| CV-180W | CV-180KW | 180 x 3.6 | 49 | 18 | CV-380W | | 380 x 7.6 | 110 | 55 |
| CV-200AW | CV-200AKW | 203 x 3.6 | 55 | 18 | CV-450W | | 450 x 8.0 | 133 | 80 |
| CV-250MW | CV-250MKW | 250 x 3.6 | 74 | 18 | CV-550W | | 550 x 8.0 | 166 | 80 |
| CV-265W | CV-265KW | 265 x 3.6 | 78 | 18 | CV-500LW | | 500 x 8.0 | 150 | 80 |
| CV-292W | CV-292KW | 292 x 3.6 | 85 | 18 | CV-610W | | 605 x 9.0 | 185 | 80 |
| CV-330W | | 330 x 3.6 | 96 | 18 | CV-685W | | 680 x 9.0 | 210 | 80 |
| CV-368SW | | 368 x 3.6 | 102 | 18 | CV-710W | | 705 x 9.0 | 220 | 80 |
| CV-200W | CV-200KW | 203 x 4.6 | 55 | 22 | CV-762W | | 762 x 9.0 | 236 | 80 |
| CV-120LW | CV-120LKW | 120 x 4.8 | 30 | 22 | CV-812W | | 812 x 9.0 | 246 | 80 |
| CV-160LW | CV-160LKW | 160 x 4.8 | 42 | 22 | CV-914W | | 914 x 9.0 | 270 | 80 |
| CV-190W | CV-190KW | 190 x 4.8 | 52 | 22 | CV-940W | | 950 x 9.0 | 285 | 80 |
| CV-250W | CV-250KW | 250 x 4.8 | 74 | 22 | CV-1168W | | 1168 x 9.0 | 360 | 80 |
| CV-280W | CV-280KW | 280 x 4.8 | 81 | 22 | CV-1219W | | 1219 x 9.0 | 380 | 80 |
| CV-300SW | | 300 x 4.8 | 85 | 22 | CV-550LW | | 550 x 12.7 | 166 | 114 |
| CV-310W | | 310 x 4.8 | 89 | 22 | | | | | |



Bridas con cabezal para tornillo

GL 14515-99HH  E97527

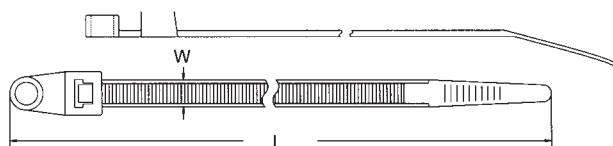
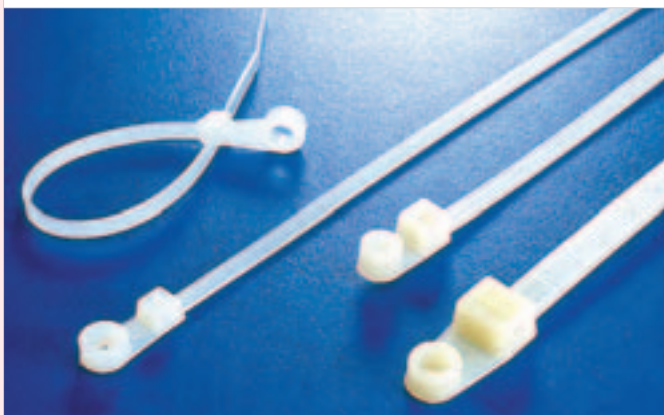

TCV-300L, TCV-400

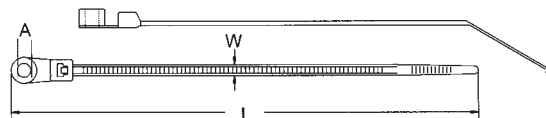

TCV-100, TCV-155, TCV-205, TCV-300, TCV-370

Material: Nylon 66 homologado  94 V-2.

Color: Natural, negro.

La brida se puede fijar al panel con un simple tornillo.

| Ref. | Dimensiones mm | | | Ø Máx. Uso mm. | Carga Kg |  |
|--|----------------|-----|------|----------------|----------|---|
| | L | W | A | | | |
| <input type="checkbox"/> TCV-100 | 100 | 2.5 | 3.0 | 25 | 8 | 100 |
| <input type="checkbox"/> TCV-155 | 155 | 3.7 | 4.8 | 40 | 18 | 100 |
| <input type="checkbox"/> TCVS-170 | 171 | 3.7 | 4.0 | 40 | 18 | 100 |
| <input type="checkbox"/> TCV-205 | 205 | 4.2 | 4.6 | 60 | 22 | 100 |
| <input type="checkbox"/> TCV-300 | 300 | 4.8 | 4.8 | 85 | 22 | 100 |
| <input type="checkbox"/> TCV-300L | 300 | 7.8 | 6.0 | 80 | 55 | 100 |
| <input type="checkbox"/> TCV-370 | 370 | 4.8 | 4.87 | 102 | 22 | 100 |
| <input type="checkbox"/> TCV-400 | 398 | 7.9 | 6.12 | 122 | 55 | 100 |
| <input checked="" type="checkbox"/> TCV-100-1 | 100 | 2.5 | 3.0 | 25 | 8 | 100 |
| <input checked="" type="checkbox"/> TCV-155-1 | 155 | 3.7 | 4.8 | 40 | 18 | 100 |
| <input checked="" type="checkbox"/> TCVS-170-1 | 171 | 3.7 | 4.0 | 40 | 18 | 100 |
| <input checked="" type="checkbox"/> TCV-205-1 | 205 | 4.2 | 4.6 | 60 | 22 | 100 |
| <input checked="" type="checkbox"/> TCV-300-1 | 300 | 4.8 | 4.8 | 85 | 22 | 100 |
| <input checked="" type="checkbox"/> TCV-300L-1 | 300 | 7.8 | 6.0 | 80 | 55 | 100 |
| <input checked="" type="checkbox"/> TCV-370-1 | 370 | 4.8 | 4.87 | 102 | 22 | 100 |
| <input checked="" type="checkbox"/> TCV-400-1 | 398 | 7.9 | 6.12 | 122 | 55 | 100 |

Bridas señalizador

 E97527

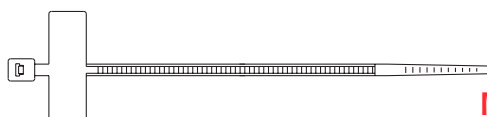

MCV-200S
MCV-100

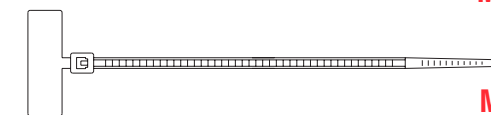

MCV-110



MCV-200
MCV-270



MCV-100L

Material: Nylon 66 homologado  94V-2

Color: Natural

Para la sujeción e identificación de cables en una sola operación.

La parte plana puede ser impresa o escrita con rotulador.

| Ref. | Dimensiones mm. | Ø Máx. Uso mm. | Carga Kg | Superficie marcado mm | |
|----------|-----------------|----------------|----------|-----------------------|---|
| | | | | mm |  |
| MCV-100 | 100 x 2.5 | 25 | 8 | 25 x 8 | 100 |
| MCV-100L | 130 x 2.5 | 25 | 8 | 28 x 20 | 100 |
| MCV-110 | 110 x 2.5 | 25 | 8 | 25 x 8 | 100 |
| MCV-200 | 200 x 4.6 | 50 | 22 | 28 x 13 | 100 |
| MCV-200S | 200 x 2.5 | 50 | 8 | 30 x 15 | 100 |
| MCV-270 | 270 x 4.6 | 75 | 22 | 28 x 13 | 100 |



Bridas de doble cierre-cabezal

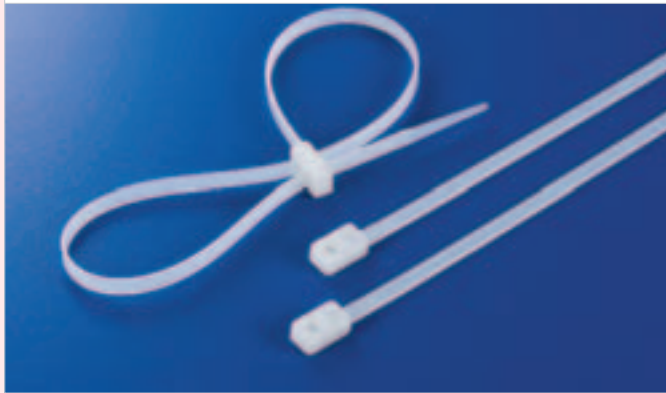

Material: Nylon 66 homologado UL 94 V-2. Color: Natural.

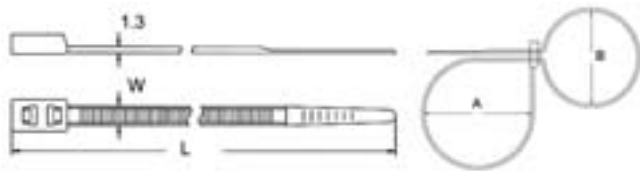

| Ref. | Dimensiones mm. L x W | \varnothing Máx. uso mm. A | \varnothing Máx. uso mm. B | Carga Kg | |
|----------------|--------------------------|---------------------------------|---------------------------------|----------|-----|
| DCV-225 | 225 x 4.8 | 59 x 2.5 | 52 x 2 | 22 | 100 |
| DCV-300 | 300 x 4.8 | 83 x 2.5 | 76 x 2 | 22 | 100 |
| DCV-370 | 370 x 4.8 | 105 x 2.5 | 98 x 2 | 22 | 100 |

Brida señalizador



Material: PE. Color: Natural.

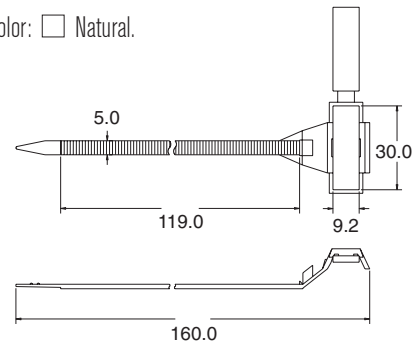

| Ref. | Dimensiones mm. | Superficie marcado mm | |
|----------------|-----------------|-----------------------|-----|
| PMT-150 | 160 x 5.0 | 30 x 9.2 | 100 |

Bridas de seguridad

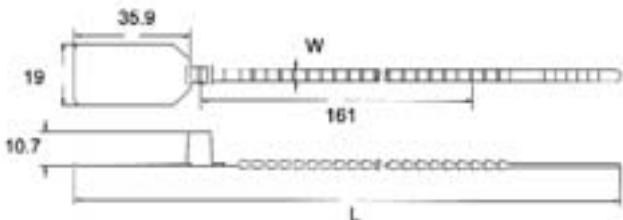

Material: Nylon 66 homologado UL 94V-2. Color: Natural.

Utilizables para la identificación de seguridad en servicios logísticos, transporte, mensajería, etc. Bajo demanda puede grabarse el logo del cliente en la placa de identificación.

| Ref. | Dimensiones mm. L x W | \varnothing Máx. Uso mm. | Superficie marcado mm. | |
|----------------|--------------------------|----------------------------|------------------------|-----|
| SCT-250 | 248.5 x 3.5 | 50 | 36 x 19 | 100 |

Bridas reutilizables

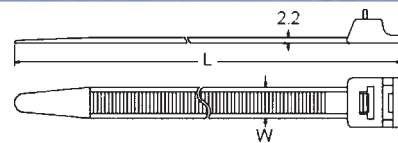

Material: Nylon 66 homologado UL 94V-2. Color: Natural.

Diseñadas para usos temporales, mientras se realizan reparaciones y se precisa mantener los cableados unidos. Su cabezal permite mantener recogida la parte sobrante de la brida.

| Ref. | Dimensiones mm. L x W | \varnothing Máx. Uso mm. | Carga Kg | |
|-------------------|--------------------------|----------------------------|----------|-----|
| HRCV-240XL | 240 x 12.8 | 60.0 | 114 | 100 |
| HRCV-300XL | 300 x 12.8 | 79.6 | 114 | 100 |
| HRCV-415XL | 415 x 12.8 | 116.0 | 114 | 100 |
| HRCV-490XL | 490 x 12.8 | 140.0 | 114 | 100 |
| HRCV-590XL | 590 x 12.8 | 171.0 | 114 | 100 |



Bridas recuperables

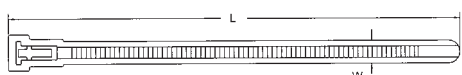

Material: Nylon 66 homologado (UL) 94V-2.

Color: Natural, negro. Estas bridas pueden ser montadas manualmente o con herramienta, permanecen cerradas de forma totalmente segura hasta que se opera intencionadamente el cierre de seguridad.

| Ref. | Dimensiones mm. L x W | Ø Máx. Uso mm. | Carga Kg | |
|--|--------------------------|-------------------|----------|-----|
| <input type="checkbox"/> HV-125 | 125 x 7.6 | 30 | 22 | 100 |
| <input type="checkbox"/> HV-150 | 150 x 7.6 | 35 | 22 | 100 |
| <input type="checkbox"/> HV-200 | 200 x 7.6 | 50 | 22 | 100 |
| <input type="checkbox"/> HV-250 | 250 x 7.6 | 65 | 22 | 100 |
| <input type="checkbox"/> HV-300 | 300 x 8.0 | 80 | 22 | 100 |
| <input checked="" type="checkbox"/> HV-125-1 | 125 x 7.6 | 30 | 22 | 100 |
| <input checked="" type="checkbox"/> HV-150-1 | 150 x 7.6 | 35 | 22 | 100 |
| <input checked="" type="checkbox"/> HV-200-1 | 200 x 7.6 | 50 | 22 | 100 |
| <input checked="" type="checkbox"/> HV-250-1 | 250 x 7.6 | 65 | 22 | 100 |
| <input checked="" type="checkbox"/> HV-300-1 | 300 x 8.0 | 80 | 22 | 100 |

Bridas recuperables

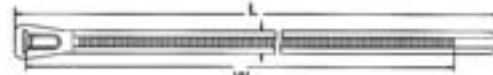

Material: Nylon 66 homologado (UL) 94V-2.

Color: Natural, negro. Estas bridas pueden ser montadas manualmente o con herramienta, permanecen cerradas de forma totalmente segura hasta que se opera intencionadamente el cierre de seguridad.

| Ref. | Dimensiones mm. L x W | Ø Máx. Uso mm. | Carga Kg | |
|---|--------------------------|-------------------|----------|-----|
| <input type="checkbox"/> HVC-125 | 125 x 7.6 | 30 | 22 | 100 |
| <input type="checkbox"/> HVC-150 | 150 x 7.6 | 35 | 22 | 100 |
| <input type="checkbox"/> HVC-200 | 203 x 7.6 | 50 | 22 | 100 |
| <input type="checkbox"/> HVC-250 | 250 x 7.6 | 65 | 22 | 100 |
| <input type="checkbox"/> HVC-300 | 300 x 7.6 | 89 | 22 | 100 |
| <input checked="" type="checkbox"/> HVC-125-1 | 125 x 7.6 | 30 | 22 | 100 |
| <input checked="" type="checkbox"/> HVC-150-1 | 150 x 7.6 | 35 | 22 | 100 |
| <input checked="" type="checkbox"/> HVC-200-1 | 203 x 7.6 | 50 | 22 | 100 |
| <input checked="" type="checkbox"/> HVC-250-1 | 250 x 7.6 | 65 | 22 | 100 |
| <input checked="" type="checkbox"/> HVC-300-1 | 300 x 7.6 | 89 | 22 | 100 |

Bridas recuperables

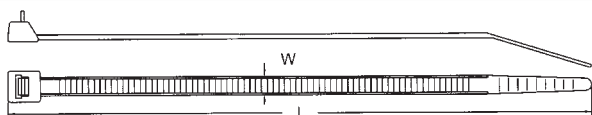

Material: Nylon 66 homologado (UL) 94V-2. Color: Natural.

Diseñadas para usos temporales. El gatillo liberador permite abrir la brida cuando se precisa removerla.

| Ref. | Dimensiones mm. L x W | Ø Máx. Uso mm. | Carga Kg | |
|------------------|--------------------------|-------------------|----------|-----|
| RCV-100 | 100 x 3.6 | 25 | 18 | 100 |
| RCV-150 | 150 x 4.7 | 39 | 22 | 100 |
| RCV-200 | 200 x 4.7 | 55 | 22 | 100 |
| RCV-250 | 250 x 4.8 | 74 | 22 | 100 |
| RCV-300 | 300 x 4.8 | 88 | 22 | 100 |
| RCV-370 | 370 x 4.8 | 102 | 22 | 100 |
| RCV-580XL | 576.6 x 12.6 | 170 | 114 | 100 |



Bridas recuperables para panel

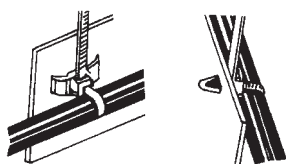
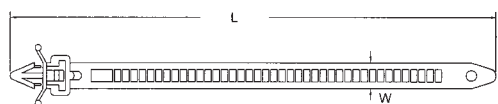

Taladro de montaje: 5.4mm.

Material: Nylon 66 homologado (UL) 94V-2. Color: Natural.

| Ref. | Dimensiones mm. L x W | Ø Máx. Uso mm. | Carga Kg | |
|----------------|--------------------------|-------------------|-------------|-----|
| PHV-150 | 150 x 8 | 37 | 40 | 100 |

Bridas de sujeción de doble cierre

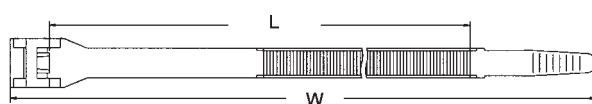

DK-200

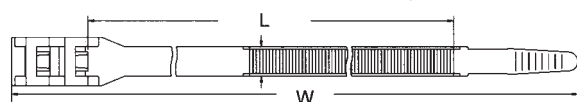

DK-290,DK-380

Material: Nylon 66 homologado (UL) 94V-2. Color: Negro.

| Ref. | Dimensiones mm. L x W | Ø Máx. Uso | Carga Kg | |
|---------------|--------------------------|---------------|----------|-----|
| DK-200 | 201 x 9.0 | 47 | 36 | 100 |
| DK-290 | 292 x 9.0 | 72 | 55 | 100 |
| DK-380 | 382 x 9.0 | 100 | 55 | 100 |

Brida de fijación por tornillo

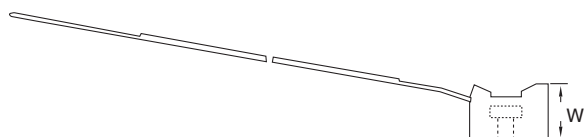
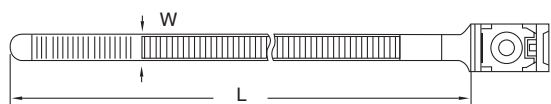

Material: Nylon 66 homologado (UL) 94V-2. Color: Natural.

| Ref. | Dimensiones mm. L x W | |
|----------------|--------------------------|-----|
| PMA-150 | 144.6 x 7.0 | 100 |



Bridas de sujeción de doble cierre

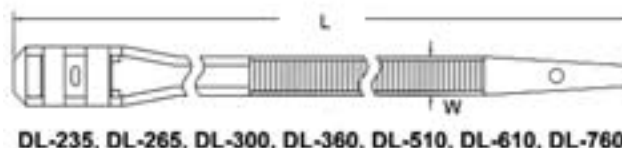

Material: Nylon homologado 94V-2.

Color: Natural, negro.

| Ref. NYLON 66 | Carga Kg | Ref. NYLON 12 | Carga Kg | Dimensiones mm. L x W | Ø Máx. Uso mm. | |
|--|-------------|---|-------------|--------------------------|-------------------|-----|
| <input type="checkbox"/> DL-132 | 35 | <input type="checkbox"/> DL-132P12 | 25 | 132 x 9.0 | 30 | 100 |
| <input type="checkbox"/> DL-180 | 35 | <input type="checkbox"/> DL-180P12 | 25 | 180 x 9.0 | 45 | 100 |
| <input type="checkbox"/> DL-235 | 55 | <input type="checkbox"/> DL-235P12 | 51 | 235 x 9.0 | 55 | 100 |
| <input type="checkbox"/> DL-265 | 55 | <input type="checkbox"/> DL-265P12 | 51 | 265 x 9.0 | 78 | 100 |
| <input type="checkbox"/> DL-300 | 55 | <input type="checkbox"/> DL-300P12 | 51 | 300 x 9.0 | 88 | 100 |
| <input type="checkbox"/> DL-360 | 55 | <input type="checkbox"/> DL-360P12 | 51 | 360 x 9.0 | 100 | 100 |
| <input type="checkbox"/> DL-510 | 55 | <input type="checkbox"/> DL-510P12 | 51 | 510 x 9.0 | 150 | 100 |
| <input type="checkbox"/> DL-610 | 55 | <input type="checkbox"/> DL-610P12 | 51 | 610 x 9.0 | 180 | 100 |
| <input type="checkbox"/> DL-760 | 55 | <input type="checkbox"/> DL-760P12 | 51 | 760 x 9.0 | 230 | 100 |
| <input checked="" type="checkbox"/> DL-132-1 | 35 | <input checked="" type="checkbox"/> DL-132P12-1 | 35 | 132 x 9.0 | 30 | 100 |
| <input checked="" type="checkbox"/> DL-180-1 | 35 | <input checked="" type="checkbox"/> DL-180P12-1 | 35 | 180 x 9.0 | 45 | 100 |
| <input checked="" type="checkbox"/> DL-235-1 | 55 | <input checked="" type="checkbox"/> DL-235P12-1 | 51 | 235 x 9.0 | 55 | 100 |
| <input checked="" type="checkbox"/> DL-265-1 | 55 | <input checked="" type="checkbox"/> DL-265P12-1 | 51 | 265 x 9.0 | 78 | 100 |
| <input checked="" type="checkbox"/> DL-300-1 | 55 | <input checked="" type="checkbox"/> DL-300P12-1 | 51 | 300 x 9.0 | 88 | 100 |
| <input checked="" type="checkbox"/> DL-360-1 | 55 | <input checked="" type="checkbox"/> DL-360P12-1 | 51 | 360 x 9.0 | 100 | 100 |
| <input checked="" type="checkbox"/> DL-510-1 | 55 | <input checked="" type="checkbox"/> DL-510P12-1 | 51 | 510 x 9.0 | 150 | 100 |
| <input checked="" type="checkbox"/> DL-610-1 | 55 | <input checked="" type="checkbox"/> DL-610P12-1 | 51 | 610 x 9.0 | 180 | 100 |
| <input checked="" type="checkbox"/> DL-760-1 | 55 | <input checked="" type="checkbox"/> DL-760P12-1 | 51 | 760 x 9.0 | 230 | 100 |



Bridas de cabezal plano

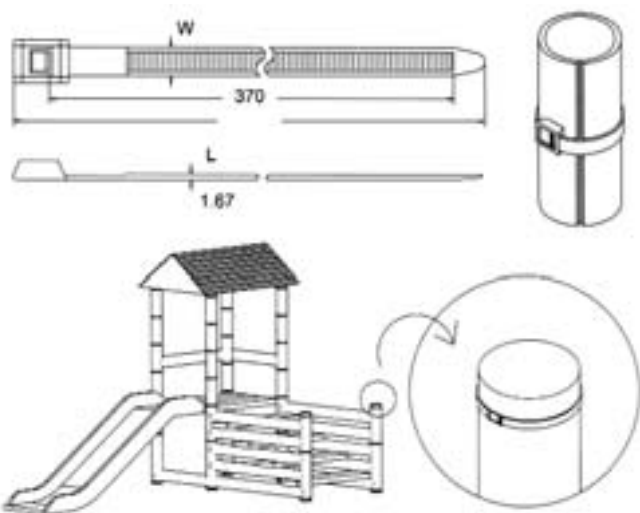

Material: Nylon 66 homologado (UL) 94V-2.

Especialmente diseñadas para uso en equipamientos infantiles ya que su cabezal plano evita posibles rasguños.

| Ref. | Dimensiones mm. L x W | |
|-------------------|--------------------------|-----|
| FCV-391-AM | 391 x 9.0 | 100 |
| FCV-391-AZ | 391 x 9.0 | 100 |
| FCV-391-RO | 391 x 9.0 | 100 |
| FCV-391-NG | 391 x 9.0 | 100 |
| FCV-391-VE | 391 x 9.0 | 100 |

Bridas con ranurado exterior

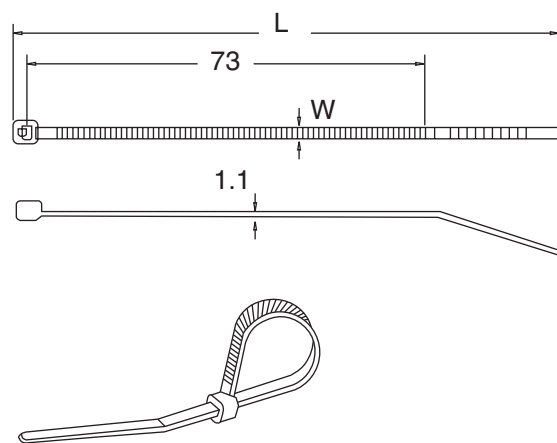

Material: Nylon 66 homologado (UL) 94V-2. Color: Natural.
Bridas diseñadas con el ranurado de cierre por su parte exterior.

| Ref. | Dimensiones mm. L x W | |
|-----------------|--------------------------|-----|
| RRCV-100 | 103 x 2.5 | 100 |



Bridas tipo nudo

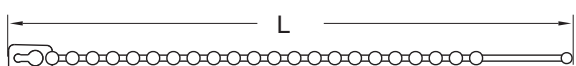

TV-100,120

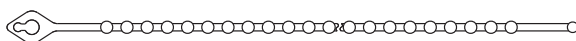

TV-150,180,280

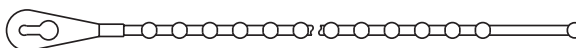

TV-230

Material: Nylon 66 homologado (UL) 94V-2.

Color: Natural.

De fácil montaje y desmontaje.

| Ref. | Dimensiones mm. L | Ø Máx. Uso mm. | Carga Kg |  |
|---------------|-------------------|----------------|----------|---|
| TV-100 | 100 mm. | 25 | 8 | 100 |
| TV-120 | 120 mm. | 30 | 8 | 100 |
| TV-150 | 150 mm. | 39 | 14 | 100 |
| TV-180 | 180 mm. | 49 | 18 | 100 |
| TV-230 | 226 mm. | 63 | 18 | 100 |
| TV-280 | 280 mm. | 75 | 22 | 100 |

Bridas tipo nudo de doble cabezal

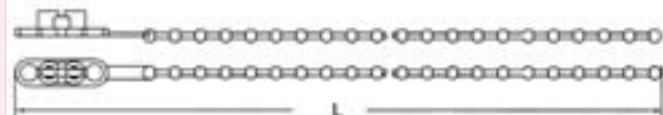

KTV-150, KTV-180, KTV-230

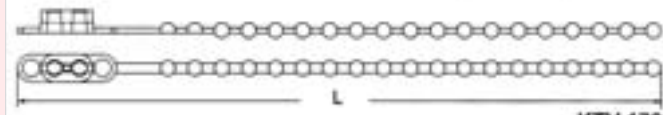

KTV-170

Material: Nylon 66 homologado (UL) 94V-2 o PE.

Color: Natural, negro.

De fácil montaje y desmontaje.

| Ref. NYLON | Ref. PE | Dimensiones mm. L | Ø Máx. Uso mm. |  |
|--|-------------------|-------------------|----------------|---|
| <input type="checkbox"/> KTV-150 | KTV-150E | 150 mm. | 38 | 100 |
| <input type="checkbox"/> KTV-170 | KTV-170E | 167,5 mm. | 41.4 | 100 |
| <input type="checkbox"/> KTV-180 | KTV-180E | 180 mm. | 46 | 100 |
| <input type="checkbox"/> KTV-230 | KTV-230E | 230 mm. | 62 | 100 |
| <input checked="" type="checkbox"/> KTV-150-1 | KTV-150E-1 | 150 mm. | 38 | 100 |
| <input checked="" type="checkbox"/> KTV-170-1 | KTV-170E-1 | 167,5 mm. | 41.4 | 100 |
| <input checked="" type="checkbox"/> KTV-180-1 | KTV-180E-1 | 180 mm. | 46 | 100 |
| <input checked="" type="checkbox"/> KTV-230-1 | KTV-230E-1 | 230 mm. | 62 | 100 |



Brida tipo nudo con fijación a panel

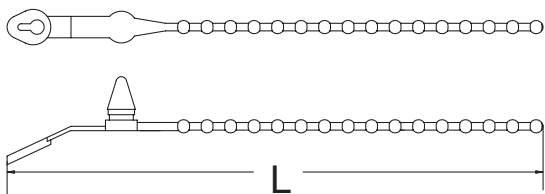

Material: Nylon 66 homologado (UL) 94V-2. Color: ■ Rojo.
De fácil montaje y desmontaje.

| Ref. | Dimensiones mm. L | Ø Máx. Uso mm. | Carga Kg. | |
|----------------|----------------------|-------------------|--------------|-----|
| STV-130 | 130 | 35 | 18 | 100 |

Brida recoge cables

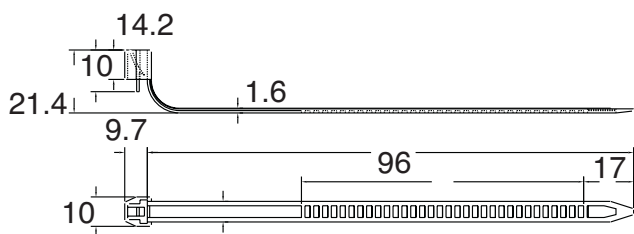

Material: Nylon 66 homologado (UL) 94V-2. Color: ■ Negro.

| Ref. | Dimensiones mm. L x W | Ø Máx. Uso mm. | Carga Kg. | |
|----------------|--------------------------|-------------------|-----------|-----|
| WCT-165 | 165 x 7 | 44 | 22 | 100 |

Bridas recoge cables

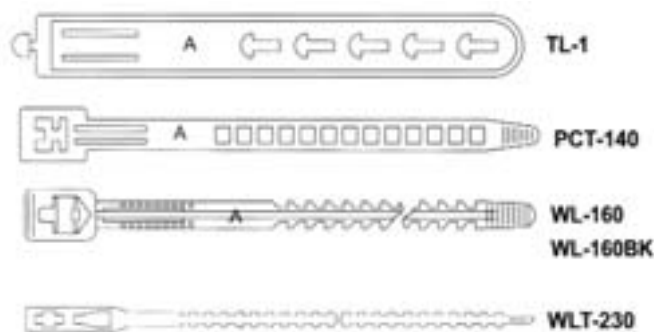

Material: Polietileno PE. Color: Natural, negro.
Para transporte y embalaje de cables. Económicas.

| Ref. | Dimensiones mm. L x W | Ø Máx. Uso mm. | Carga Kg. | |
|---|--------------------------|-------------------|-----------|-----|
| <input type="checkbox"/> TL-1 | 130 x 15 | 35 | 14 | 100 |
| <input type="checkbox"/> PCT-140 | 140 x 9 | 38 | 8 | 100 |
| <input type="checkbox"/> WL-160 | 160 x 9 | 45 | 8 | 100 |
| <input type="checkbox"/> WLT-230 | 234 x 5.5 | 50 | - | 100 |
| <input checked="" type="checkbox"/> WL-160-1 | 160 x 9 | 45 | 8 | 100 |



Bridas de montaje en panel

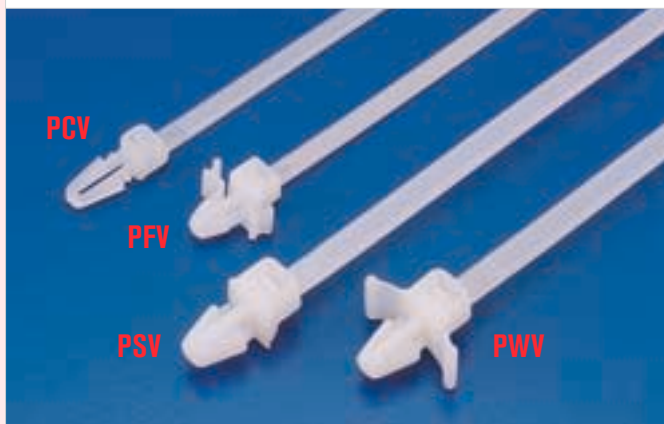

PCV



PFV

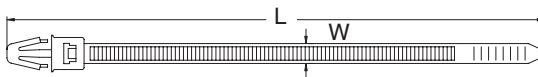

PSV

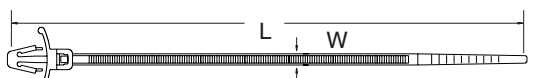

PWV

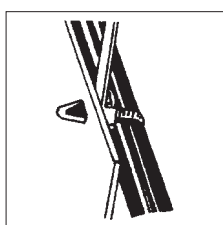
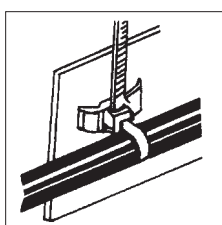

Material: Nylon 66 negro homologado (UL) 94V-2. Color: Natural.

| Ref. | Dimensiones mm. | | Ø Máx. Uso mm. | Carga Kg | Taladro de montaje | |
|-----------------|-----------------|--|----------------|----------|--------------------|-----|
| | L x W | | | | | |
| PCVS-130 | 130 x 4.8 | | 30 | 22 | 4.8 | 100 |
| PCV-155 | 155 x 3.5 | | 40 | 18 | 4.8 | 100 |
| PCVS-200 | 203 x 4.8 | | 50 | 22 | 4.8 | 100 |
| PCV-200 | 203 x 4.8 | | 50 | 22 | 6.4 | 100 |
| PFVS-130 | 130 x 3.5 | | 30 | 18 | 4.8 | 100 |
| PFVS-200 | 200 x 3.5 | | 50 | 18 | 4.8 | 100 |
| PSV-130 | 130 x 4.8 | | 30 | 22 | 6.4 | 100 |
| PSV-200 | 200 x 4.8 | | 50 | 22 | 6.4 | 100 |
| PWVS-100 | 112 x 2.5 | | 25 | 8 | 4.6 | 100 |
| PWVS-130 | 132.8 x 4.8 | | 30 | 22 | 4.6 | 100 |
| PWVS-155 | 155 x 3.5 | | 36 | 18 | 4.6 | 100 |
| PWV-130 | 130 x 4.8 | | 30 | 22 | 6.0 | 100 |
| PWV-200 | 200 x 4.8 | | 50 | 22 | 6.0 | 100 |

Bridas para fijación en canaleta

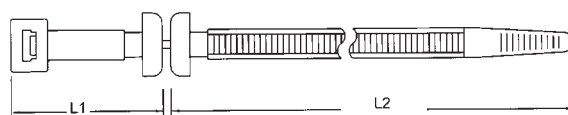

Material: Nylon 66 homologado (UL) 94V-2. Color: Negro.

Esta brida soluciona el problema de la fijación de los cables en las canaletas. Fabricada de una sola pieza, se parte facilmente para ser ambas partes introducidas en los orificios de la canaleta.

| Ref. | Dimensiones mm. | | | | Carga Kg | |
|----------------|-----------------|----|-----|-----|----------|-----|
| | L | L1 | L2 | W | | |
| CTF-320 | 320 | 39 | 279 | 7.6 | 55 | 100 |

Brida sujetacables con tope



Material: Nylon 66 homologado (UL) 94V-2. Color: Natural.

| Ref. | Dimensiones mm. | | Ø Máx. Uso mm. | Carga Kg | |
|----------------|-----------------|--|----------------|----------|-----|
| | L x W | | | | |
| CVS-140 | 140 x 3.2 | | 20 | 18 | 100 |
| CVS-190 | 190 x 4.8 | | 45 | 22 | 100 |



Bridas mágicas



Autopegables, autoajustables, de fácil manejo, duraderas y no corrosivas. Especial para aplicaciones en telecomunicaciones, cables de fibra óptica, eléctricos y

multiusos. Su gama de seis colores, cinco largos y dos anchos la convierten, además de muy útil, en altamente decorativa. Muy resistente a vibraciones.

| Ref. | Dimensiones mm. | | Ø Máx. Uso mm. | | Ref. | Dimensiones mm. | | Ø Máx. Uso mm. | |
|--------------|-----------------|-------|----------------|----|--------------|-----------------|-------|----------------|----|
| | Largo | Ancho | | | | Largo | Ancho | | |
| ■ MGT-125-NG | 125 | 12 | 30 | 20 | □ MGT-180-BL | 180 | 12 | 40 | 20 |
| ■ MGT-125-AM | 125 | 12 | 30 | 20 | ■ MGT-180-RO | 180 | 12 | 40 | 20 |
| ■ MGT-125-AZ | 125 | 12 | 30 | 20 | ■ MGT-180-VE | 180 | 12 | 40 | 20 |
| □ MGT-125-BL | 125 | 12 | 30 | 20 | ■ MGT-210-NG | 210 | 16 | 50 | 20 |
| ■ MGT-125-RO | 125 | 12 | 30 | 20 | ■ MGT-210-AM | 210 | 16 | 50 | 20 |
| ■ MGT-125-VE | 125 | 12 | 30 | 20 | ■ MGT-210-AZ | 210 | 16 | 50 | 20 |
| ■ MGT-135-NG | 135 | 12 | 33 | 20 | □ MGT-210-BL | 210 | 16 | 50 | 20 |
| ■ MGT-135-AM | 135 | 12 | 33 | 20 | ■ MGT-210-RO | 210 | 16 | 50 | 20 |
| ■ MGT-135-AZ | 135 | 12 | 33 | 20 | ■ MGT-210-VE | 210 | 16 | 50 | 20 |
| □ MGT-135-BL | 135 | 12 | 33 | 20 | ■ MGT-310-NG | 310 | 16 | 85 | 20 |
| ■ MGT-135-RO | 135 | 12 | 33 | 20 | ■ MGT-310-AM | 310 | 16 | 85 | 20 |
| ■ MGT-135-VE | 135 | 12 | 33 | 20 | ■ MGT-310-AZ | 310 | 16 | 85 | 20 |
| ■ MGT-180-NG | 180 | 12 | 40 | 20 | □ MGT-310-BL | 310 | 16 | 85 | 20 |
| ■ MGT-180-AM | 180 | 12 | 40 | 20 | ■ MGT-310-RO | 310 | 16 | 85 | 20 |
| ■ MGT-180-AZ | 180 | 12 | 40 | 20 | ■ MGT-310-VE | 310 | 16 | 85 | 20 |

Bridas metálicas aisladas



Material: Hierro acerado + aislante PVC.

Bridas especialmente diseñadas para la sujeción de cables, tubos, etc., en el sector eléctrico del automóvil.

| Ref. | |
|-----------|-----|
| ■ BS-3000 | 200 |
| ■ BS-3001 | 200 |



Bridas ranuradas de acero inoxidable



Material: Acero inoxidable de 0,3 mm. de grosor (T)

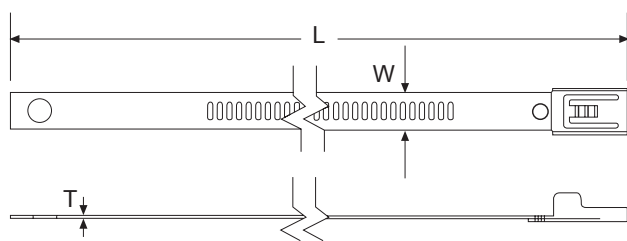

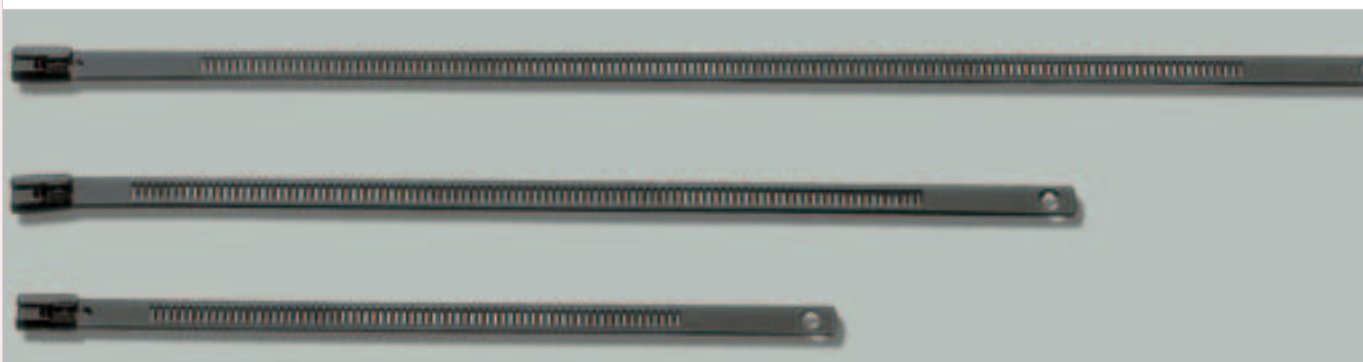

| Ref. | Ø Máx. Uso mm | Largo "L" mm | Ancho "W" mm | Carga Kg |  |
|-----------------|---------------|--------------|--------------|----------|---|
| STL-195S | 45 | 195 | 7 | 34.0 | 10 |
| STL-255S | 64 | 255 | 7 | 34.0 | 10 |
| STL-335S | 89 | 335 | 7 | 34.0 | 10 |
| STL-490S | 139 | 490 | 7 | 34.0 | 10 |
| STL-635S | 185 | 635 | 7 | 34.0 | 10 |
| STL-195M | 45 | 195 | 12 | 45.3 | 10 |
| STL-255M | 64 | 255 | 12 | 45.3 | 10 |
| STL-335M | 89 | 335 | 12 | 45.3 | 10 |
| STL-490M | 139 | 490 | 12 | 45.3 | 10 |
| STL-635M | 185 | 635 | 12 | 45.3 | 10 |

Bridas ranuradas de acero inoxidable forradas en NYLON

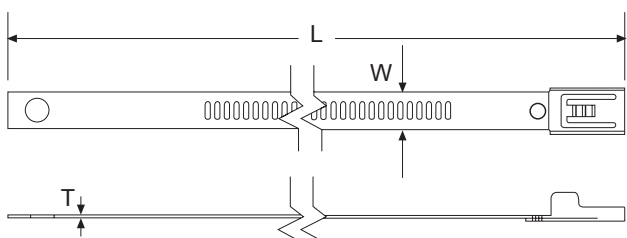

Material: Acero inoxidable de 0,3 mm. de grosor (T)
forrado en NYLON 11 negro.



| Ref. | Ø Máx. Uso mm | Largo "L" mm | Ancho "W" mm | Carga Kg |  |
|------------------|---------------|--------------|--------------|----------|---|
| STLC-195S | 45 | 195 | 7 | 34.0 | 10 |
| STLC-255S | 64 | 255 | 7 | 34.0 | 10 |
| STLC-335S | 89 | 335 | 7 | 34.0 | 10 |
| STLC-490S | 139 | 490 | 7 | 34.0 | 10 |
| STLC-635S | 185 | 635 | 7 | 34.0 | 10 |
| STLC-195M | 45 | 195 | 12 | 45.3 | 10 |
| STLC-255M | 64 | 255 | 12 | 45.3 | 10 |
| STLC-335M | 89 | 335 | 12 | 45.3 | 10 |
| STLC-490M | 139 | 490 | 12 | 45.3 | 10 |
| STLC-635M | 185 | 635 | 12 | 45.3 | 10 |



Bridas ranuradas de acero inoxidable forradas en NYLON



Material: Acero inoxidable de 0,5 mm. de grosor (T)
forrado en nylon 11 negro

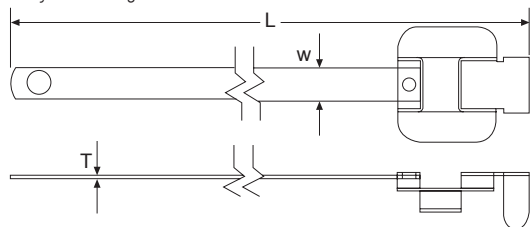

| Ref. | Ø Máx. Uso mm | Largo "L" mm | Ancho "W" mm | Carga Kg | |
|-----------------|---------------|--------------|--------------|----------|----|
| STC-152S | 38 | 152 | 6.3 | 136 | 10 |
| STC-229S | 63 | 229 | 6.3 | 136 | 10 |
| STC-305S | 86 | 305 | 6.3 | 136 | 10 |
| STC-457S | 137 | 457 | 6.3 | 136 | 10 |
| STC-610S | 185 | 610 | 6.3 | 136 | 10 |

Bridas lisas con cierre de bloqueo por bola



Material: Acero inoxidable de 0,3 mm. de grosor (T)

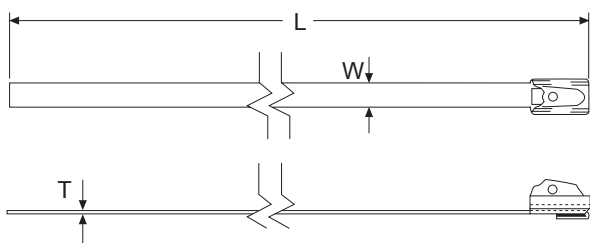

| Ref. | Ø Máx. Uso mm | Largo "L" mm | Ancho "W" mm | Carga Kg | |
|------------------|---------------|--------------|--------------|----------|----|
| STB-520S | 152 | 520 | 4.5 | 45.3 | 10 |
| STB-680S | 203 | 680 | 4.5 | 45.3 | 10 |
| STB-840S | 254 | 840 | 4.5 | 45.3 | 10 |
| STB-1050S | 318 | 1050 | 4.5 | 45.3 | 10 |
| STB-152M | 25 | 152 | 8.0 | 113.3 | 10 |
| STB-200M | 50 | 200 | 8.0 | 113.3 | 10 |
| STB-360M | 102 | 360 | 8.0 | 113.3 | 10 |
| STB-520M | 152 | 520 | 8.0 | 113.3 | 10 |
| STB-680M | 203 | 680 | 8.0 | 113.3 | 10 |
| STB-840M | 254 | 840 | 8.0 | 113.3 | 10 |
| STB-1050M | 318 | 1050 | 8.0 | 113.3 | 10 |

| Ref. | Ø Máx. Uso mm | Largo "L" mm | Ancho "W" mm | Carga Kg | |
|-----------------|---------------|--------------|--------------|----------|----|
| STB-152S | 25 | 152 | 4.5 | 45.3 | 10 |
| STB-200S | 50 | 200 | 4.5 | 45.3 | 10 |
| STB-360S | 102 | 360 | 4.5 | 45.3 | 10 |

Pistolas para tensar y cortar bridas metálicas



Ref.: **STG-200**
Pistola para tensar y cortar bridas metálicas ranuradas y con cierre de bloqueo por bola.

: 1



Ref.: **LY-600-N**
Pistola para tensar y cortar bridas metálicas ranuradas y con cierre de bloqueo por bola.

: 1



Tubo espiral



KS-30YW

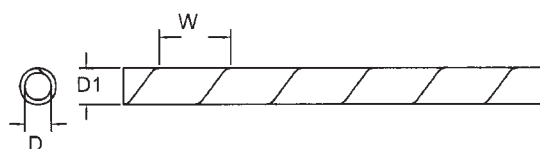

Material: Polietileno de baja presión retardador de la llama.

Color: Natural, negro. Otros colores bajo demanda.

Aplicaciones: Construcción rápida y económica de haces de cables. Protección flexible del mazo de cables que va hasta la puerta de los paneles eléctricos.

Formación o sujeción de haces de pequeños tubos hidráulicos o neumáticos en máquinas de control automático. De fácil aplicación y montaje, proporciona a las haces de cables la máxima protección sin restar flexibilidad.

Re-utilizable en nuevos montajes. Temperatura de trabajo: - 60°C y + 85°C

| Ref. <input type="checkbox"/> | Ref. <input checked="" type="checkbox"/> | Ref. <input type="checkbox"/> | Dimensiones mm. | | | Ø Mín y máx mm. | |
|--|---|--|-----------------|-----|------|-----------------|-----------|
| | | | D | D1 | W | | |
| <input type="checkbox"/> KS-3 | <input checked="" type="checkbox"/> KS-3-1 | | 1.5 | 3 | 4.0 | 15-18 | 10m/rollo |
| <input type="checkbox"/> KS-6 | <input checked="" type="checkbox"/> KS-6-1 | | 3.2 | 4.5 | 7.0 | 10-15 | 10m/rollo |
| <input type="checkbox"/> KS-6L | <input checked="" type="checkbox"/> KS-6L-1 | | 4.1 | 6.2 | 7.0 | 10-15 | 10m/rollo |
| <input type="checkbox"/> KS-6.5 | <input checked="" type="checkbox"/> KS-6.5-1 | | 5 | 6.2 | 7.5 | 10-15 | 10m/rollo |
| <input type="checkbox"/> KS-8 | <input checked="" type="checkbox"/> KS-8-1 | | 6 | 8 | 10.8 | 15-60 | 10m/rollo |
| <input type="checkbox"/> KS-10 | <input checked="" type="checkbox"/> KS-10-1 | | 7.5 | 10 | 11.4 | 20-60 | 10m/rollo |
| <input type="checkbox"/> KS-12 | <input checked="" type="checkbox"/> KS-12-1 | | 9 | 12 | 13.9 | 20-65 | 10m/rollo |
| <input type="checkbox"/> KS-15 | <input checked="" type="checkbox"/> KS-15-1 | | 12 | 15 | 15.0 | 20-70 | 10m/rollo |
| <input type="checkbox"/> KS-19 | <input checked="" type="checkbox"/> KS-19-1 | | 15 | 19 | 18.2 | 25-100 | 10m/rollo |
| <input type="checkbox"/> KS-24 | <input checked="" type="checkbox"/> KS-24-1 | | 20 | 24 | 19.6 | 20-130 | 10m/rollo |
| | | <input checked="" type="checkbox"/> KS-30YW | 26 | 30 | 43 | 26-160 | 2m/pc |



Banda para revestimiento de cables

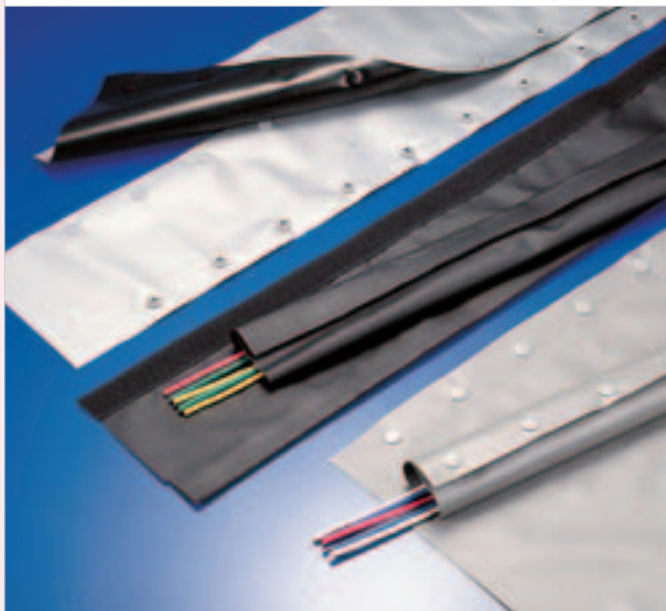

Material: PVC. Ratio de flamabilidad: 94V-0
Aplicación: de fácil instalación y re-utilizable.

Tipo botón

| Ref. | Ref. Negro/Gris | Distancia entre cierres | Ø Máx. Uso mm. | |
|-------------------------------|-------------------------------|-------------------------|----------------|------|
| <input type="checkbox"/> Gris | <input type="checkbox"/> Gris | | | |
| WB-40 | WBS-40 | 40 | 12 | 55 m |
| WB-47 | WBS-47 | 47 | 15 | 55 m |
| WB-60 | WBS-60 | 60 | 20 | 55 m |
| WB-80 | WBS-80 | 80 | 25 | 55 m |
| WB-100 | WBS-100 | 100 | 30 | 55 m |
| WB-128 | WBS-128 | 128 | 40 | 55 m |
| WB-140 | WBS-140 | 140 | 44 | 55 m |
| WB-150 | WBS-150 | 150 | 47 | 55 m |
| WB-160 | WBS-160 | 160 | 50 | 55 m |
| WB-182 | WBS-182 | 182 | 57 | 55 m |
| WB-222 | WBS-222 | 222 | 70 | 55 m |
| WB-315 | WBS-315 | 315 | 100 | 55 m |
| WB-475 | WBS-475 | 475 | 150 | 55 m |

Tipo Velcro®

| Ref. | Ancho mm. | Ø Máx. Uso mm. | |
|--------------------------------|-----------|----------------|------|
| <input type="checkbox"/> Negro | | | |
| WBT-84 | 84 | 20 | 55 m |
| WBT-100 | 100 | 25 | 55 m |
| WBT-115 | 115 | 30 | 55 m |
| WBT-147 | 147 | 40 | 55 m |
| WBT-183 | 183 | 50 | 55 m |
| WBT-246 | 246 | 70 | 55 m |
| WBT-340 | 340 | 100 | 55 m |

Cinta sujetacables en bobina

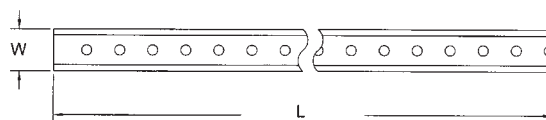

Material: PVC. Color: Natural, negro. Fabricada en PVC con excepcional resistencia a los efectos del agua, grasa y productos químicos.
Aplicaciones: Para la sujeción de cables, tubos y cableados. Bajo coste para aplicaciones permanentes. Aplicación muy simple, con solo abrochar el botón.

| Ref. | Dimensiones W | L | | Ref. BOTÓN | |
|---|---------------|------|---|--|-----|
| <input type="checkbox"/> A-6-0 | 6.0 mm. | 10 m | 1 | <input type="checkbox"/> A-6B-0 | 100 |
| <input checked="" type="checkbox"/> A-6-1 | 6.0 mm. | 10 m | 1 | <input checked="" type="checkbox"/> A-6B-1 | 100 |
| <input type="checkbox"/> A-8-0 | 8.0 mm. | 10 m | 1 | <input type="checkbox"/> A-8B-0 | 100 |
| <input checked="" type="checkbox"/> A-8-1 | 8.0 mm. | 10 m | 1 | <input checked="" type="checkbox"/> A-8B-1 | 100 |
| <input type="checkbox"/> A-10-0 | 10.0 mm. | 10 m | 1 | <input type="checkbox"/> A-10B-0 | 100 |
| <input checked="" type="checkbox"/> A-10-1 | 10.0 mm. | 10 m | 1 | <input checked="" type="checkbox"/> A-10B-1 | 100 |
| <input type="checkbox"/> A-12-0 | 12.0 mm. | 10 m | 1 | <input type="checkbox"/> A-12B-0 | 100 |
| <input checked="" type="checkbox"/> A-12-1 | 12.0 mm. | 10 m | 1 | <input checked="" type="checkbox"/> A-12B-1 | 100 |

Hilo para atado de cables



Material: PVC. Hilo macizo. Diámetro: 1mm. Color: Natural
Unidad envase: Por madejas.

| Ref. | Medida | |
|------------|--------|----------|
| B-1 | 1.0mm | 1 madeja |



Cordón metálico forrado de PVC



Ref.:

- M-1-NG
- M-1-BL
- M-1-AZ
- M-1-AM
- M-1-VE

Metros por rollo:
280 aprox.
Cordón de PVC para
atado de cables y otros
"mil" usos.

Abrazadera-remache para panel



Cordón en PET



- Ref.:
- PET-1-BL
 - PET-1-NG

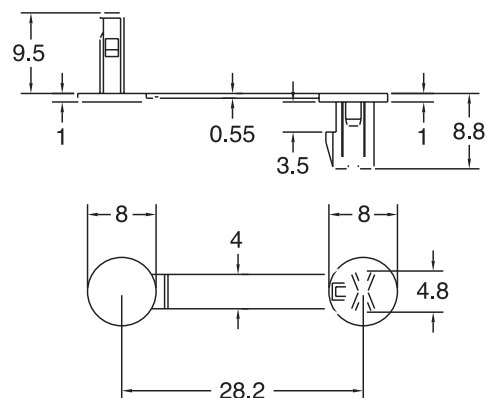

Material: Nylon 66 homologado (UL) 94V-2.

| Ref. | Medidas | |
|---------------|--------------|-----|
| SNB-03 | Según figura | 100 |

¿Sabía qué...

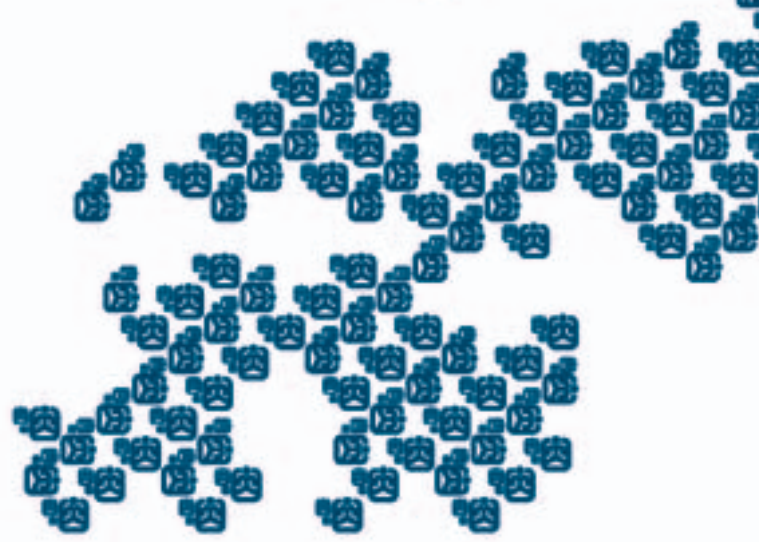

...X.B. components, s.a. cuenta con un centro de distribución de 3000 m² en Barcelona, así como con otro centro de distribución de 1500 m² en Madrid y una oficina comercial en París?





GRAPAS DE SUJECION



Grapas de sujeción

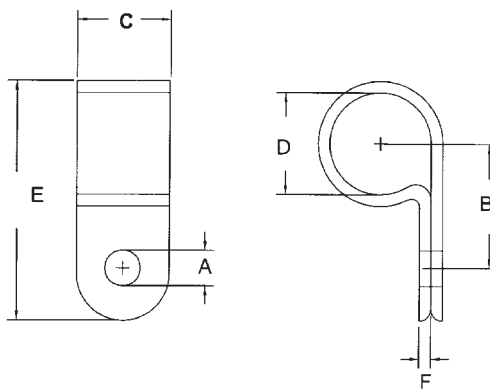

Material: Nylon 66 homologado (UL) 94V-2.

Grapas especialmente diseñadas para la sujeción de cables, tubos y otros componentes en electrodomésticos, aparatos eléctricos y electrónicos.

Los fillos interiores están angulados para la protección del aislante.

Aplicación muy simple mediante tornillo al chasis.

Colores: Natural, negro.

| Ref. <input type="checkbox"/> natural | Ref. <input checked="" type="checkbox"/> negro | Dimensiones mm. | | C | D | E | F | |
|--|---|-----------------|------|------|------|------|-----|-----|
| | | A | B | | | | | |
| <input type="checkbox"/> UC-0 | <input checked="" type="checkbox"/> UC-0-1 | 4.6 | 9.5 | 9.6 | 3.2 | 19.8 | 1.4 | 100 |
| <input type="checkbox"/> UC-0.5 | <input checked="" type="checkbox"/> UC-0.5-1 | 4.6 | 10.5 | 9.6 | 4.8 | 19.8 | 1.4 | 100 |
| <input type="checkbox"/> UC-1 | <input checked="" type="checkbox"/> UC-1-1 | 4.6 | 10.0 | 10.0 | 6.35 | 20.0 | 1.4 | 100 |
| <input type="checkbox"/> UC-1.5 | <input checked="" type="checkbox"/> UC-1.5-1 | 4.6 | 12.0 | 10.0 | 7.9 | 22.0 | 1.5 | 100 |
| <input type="checkbox"/> UC-2 | <input checked="" type="checkbox"/> UC-2-1 | 4.6 | 12.5 | 12.0 | 9.5 | 24.0 | 1.5 | 100 |
| <input type="checkbox"/> UC-3 | <input checked="" type="checkbox"/> UC-3-1 | 4.6 | 15.2 | 12.0 | 12.7 | 31.0 | 1.5 | 100 |
| <input type="checkbox"/> UC-4 | <input checked="" type="checkbox"/> UC-4-1 | 4.6 | 18.2 | 12.0 | 15.8 | 34.3 | 1.5 | 100 |
| <input type="checkbox"/> UC-5 | <input checked="" type="checkbox"/> UC-5-1 | 4.6 | 18.2 | 12.0 | 19.4 | 35.0 | 1.5 | 100 |
| <input type="checkbox"/> UC-6 | <input checked="" type="checkbox"/> UC-6-1 | 4.6 | 22.0 | 12.0 | 25.4 | 43.0 | 1.8 | 100 |
| <input type="checkbox"/> UC-6.5 | <input checked="" type="checkbox"/> UC-6.5-1 | 4.6 | 24.0 | 12.0 | 27.5 | 50.0 | 1.8 | 100 |
| <input type="checkbox"/> UC-7 | <input checked="" type="checkbox"/> UC-7-1 | 4.6 | 26.2 | 12.0 | 31.8 | 46.2 | 1.8 | 100 |
| <input type="checkbox"/> UC-9 | <input checked="" type="checkbox"/> UC-9-1 | 4.6 | 30.0 | 12.0 | 36.7 | 50.0 | 1.8 | 100 |



Bases autoadhesivas para soporte de bridas

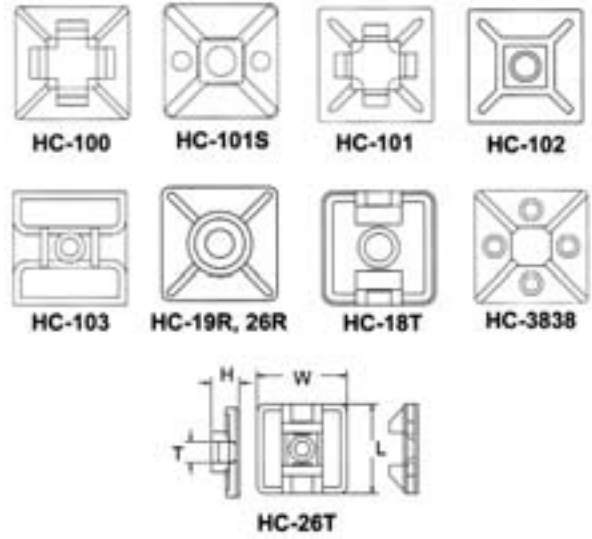
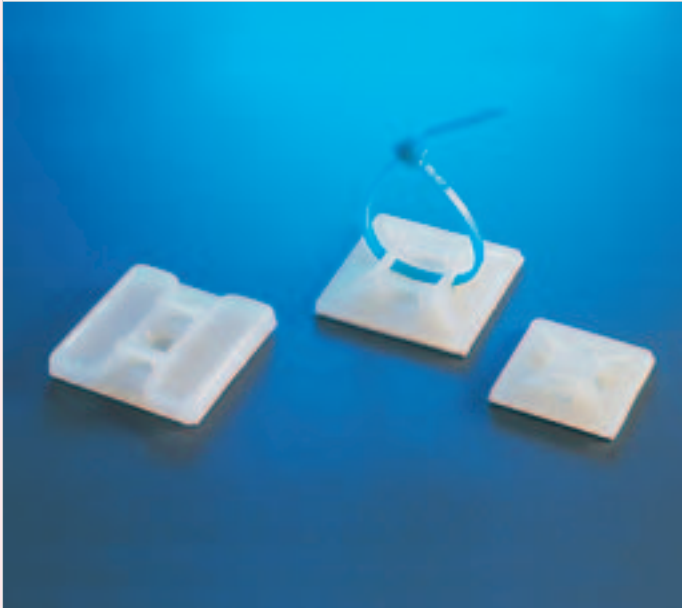

Material: Nylon 66 homologado (UL) 94V-2.

Colores: Natural, negro.

Diseñadas para aguantar bridas con cables de peso ligero, deben ser aplicadas sobre superficies limpias, planas, sin restos de grasa, etc. Para un aguante superior pueden ser fijadas adicionalmente, en algunos casos, mediante tornillo.

| Ref. <input type="checkbox"/> natural | Ref. <input checked="" type="checkbox"/> negro | Dimensiones mm. | | | Ø Taladro mm. | T | |
|--|---|-----------------|------|-----|------------------|-----|-------|
| | | AL | W | H | | | |
| <input type="checkbox"/> HC-100-S4 | <input checked="" type="checkbox"/> HC-100-S4-1 | 12.5 | 12.5 | 3.2 | - | 3.2 | 100 * |
| <input type="checkbox"/> HC-100S-S2 | <input checked="" type="checkbox"/> HC-100S-S2-1 | 19 | 19 | 3.9 | 3.2 | 4.5 | 100 * |
| <input type="checkbox"/> HC-101S | <input checked="" type="checkbox"/> HC-101S-1 | 19 | 19 | 3.9 | 3.2 | 4.5 | 100 |
| <input type="checkbox"/> HC-101 | <input checked="" type="checkbox"/> HC-101-1 | 21 | 21 | 3.5 | - | 4.7 | 100 |
| <input type="checkbox"/> HC-102 | <input checked="" type="checkbox"/> HC-102-1 | 28 | 28 | 4 | 5.0 | 5.0 | 100 |
| <input type="checkbox"/> HC-103 | <input checked="" type="checkbox"/> HC-103-1 | 28 | 28 | 4 | 5.0 | 5.0 | 100 |
| <input type="checkbox"/> HC-25 | <input checked="" type="checkbox"/> HC-25-1 | 25.8 | 25.8 | 6.1 | - | 8.0 | 100 |
| <input type="checkbox"/> HC-19R | <input checked="" type="checkbox"/> HC-19R-1 | 18 | 18 | 4.5 | 5.0 | 4.5 | 100 |
| <input type="checkbox"/> HC-26R | <input checked="" type="checkbox"/> HC-26R-1 | 26.3 | 26.3 | 5.9 | 5.0 | 5.6 | 100 |
| <input type="checkbox"/> HC-18T | <input checked="" type="checkbox"/> HC-18T-1 | 18.9 | 18.9 | 4.9 | 5.0 | 4.1 | 100 |
| <input type="checkbox"/> HC-26T | <input checked="" type="checkbox"/> HC-26T-1 | 26.3 | 26.3 | 7.3 | 5.0 | 6.2 | 100 |
| <input type="checkbox"/> HC-3838 | <input checked="" type="checkbox"/> HC-3838-1 | 38 | 38 | 7.5 | 5.0 | 10 | 100 |

* HC-100-S4: 4 piezas en una tira.
HC-102S-S2: 2 piezas en una tira.



Bases de fijación por tornillo para bridas



Material: Nylon 66 homologado (UL) 94V-2. Colores: □ Natural, ■ negro

Para utilizar con bridas: HC-0: CV-075, CV-094, . . . , CV-280, CV-310

HC-1: CV-075, CV-094, . . . , CV-280, CV-310

HC-2: con todas las medidas.

Su especial diseño ofrece una máxima estabilidad a los cableados.

De fácil montaje con tornillos.

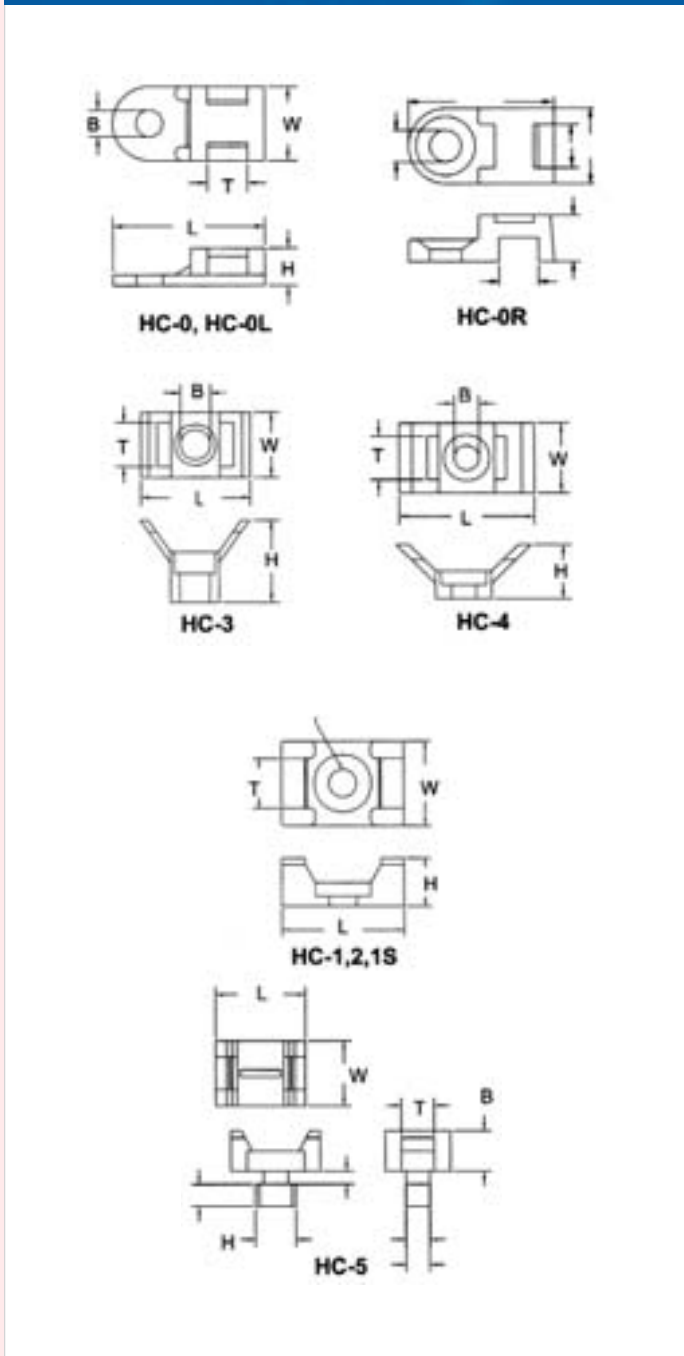

| Ref. | Dimensiones mm. | | | | | |
|-----------|-----------------|------|------|-----|---------|-----|
| | H | L | W | T | B | |
| □ HC-0 | 5 | 19 | 9.5 | 5 | 3.4 | 100 |
| □ HC-0L | 5 | 19 | 9.5 | 5 | 5.2 | 100 |
| □ HC-0R | 6.2 | 19.1 | 10 | 5.4 | 4.2 | 100 |
| □ HC-1 | 7 | 15 | 10 | 5 | 3 | 100 |
| □ HC-1S | 5.8 | 12.8 | 7 | 4.0 | 3.3 | 100 |
| □ HC-2S | 9 | 23 | 16 | 9 | 5 | 100 |
| □ HC-2 | 9 | 23 | 16 | 9 | 6 | 100 |
| □ HC-2L | 9 | 23 | 16 | 9 | 6.5 | 100 |
| □ HC-3 | 17.5 | 23 | 13.8 | 9.5 | 5.3 | 100 |
| □ HC-4 | 11.6 | 30 | 14.7 | 9.3 | 5.2 | 100 |
| □ HC-5 | 9.7 | 21.3 | 15.5 | 7.8 | 5.8x9.7 | 100 |
| ■ HC-0-1 | 5 | 19 | 9.5 | 5 | 3.4 | 100 |
| ■ HC-0L-1 | 5 | 19 | 9.5 | 5 | 5.2 | 100 |
| ■ HC-0R-1 | 6.2 | 19.1 | 10 | 5.4 | 4.2 | 100 |
| ■ HC-1-1 | 7 | 15 | 10 | 5 | 3 | 100 |
| ■ HC-1S-1 | 5.8 | 12.8 | 7 | 4.0 | 3.3 | 100 |
| ■ HC-2S-1 | 9 | 23 | 16 | 9 | 5 | 100 |
| ■ HC-2-1 | 9 | 23 | 16 | 9 | 6 | 100 |
| ■ HC-2L-1 | 9 | 23 | 16 | 9 | 6.5 | 100 |
| ■ HC-3-1 | 17.5 | 23 | 13.8 | 9.5 | 5.3 | 100 |
| ■ HC-4-1 | 11.6 | 30 | 14.7 | 9.3 | 5.2 | 100 |
| ■ HC-5-1 | 9.7 | 21.3 | 15.5 | 7.8 | 5.8x9.7 | 100 |



Tacos a presión para soporte de bridas

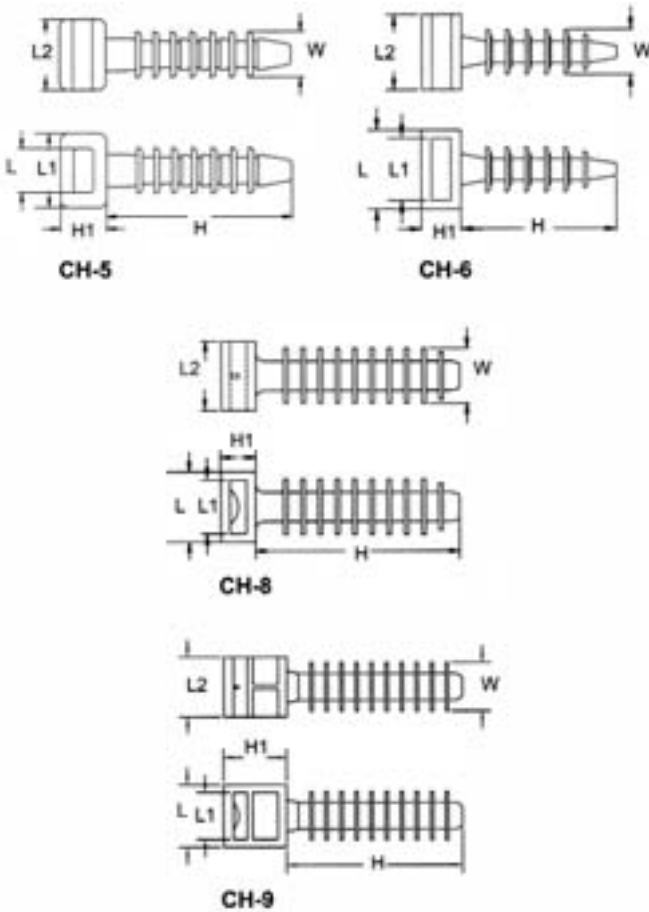

Material: Nylon 66 homologado (UL) 94V-2. Color: ■ Negro.

| Ref. | Dimensiones mm. | | | | | | |
|-------------|-----------------|-----|------|------|-----|------|-----|
| | H | H1 | W | L | L1 | L2 | |
| CH-5 | 24.3 | 6.1 | 6 | 9.74 | 5.8 | 9.34 | 100 |
| CH-6 | 24.7 | 6.3 | 7.2 | 12.5 | 9.9 | 12.0 | 100 |
| CH-8 | 37.0 | 6.3 | 10.0 | 12.7 | 9.7 | 12.5 | 100 |
| CH-9 | 36.2 | 13 | 10.0 | 12.9 | 9.7 | 12.4 | 100 |

Abrazaderas de sujeción adhesivas y con tornillo

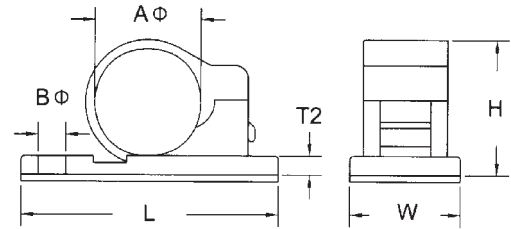
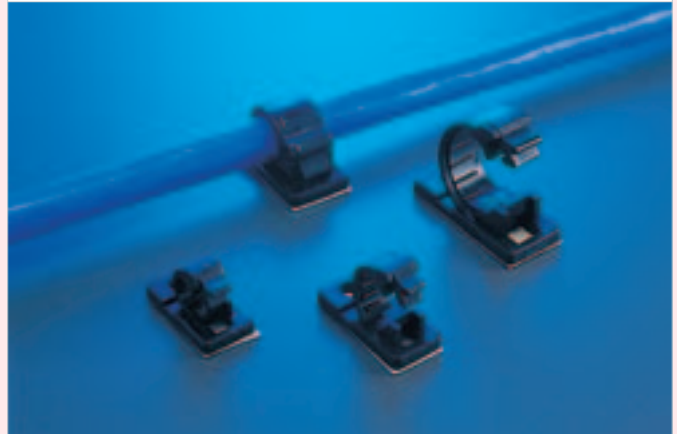

Material: Nylon 66 homologado (UL) 94V-2 y con adhesivo de alta calidad en la base. Color: ■ Negro.

Diseñadas para la sujeción de cables y tubos en superficies donde no se pueden practicar orificios. Aplicable en casi todo tipo de superficies limpias y lisas. También tienen taladro de sujeción mediante tornillo.

| Ref. | Dimensiones mm. | | | | | | |
|--------------|-----------------|-----|-----|------|------|------|-----|
| | AØ | BØ | T1 | L | W | H | |
| 4J-S | 6 | 4.4 | 2.0 | 25.8 | 13.4 | 9.1 | 100 |
| 6J-S | 9 | 4.4 | 3.0 | 29.4 | 13.4 | 14.0 | 100 |
| 8J-S | 12 | 4.4 | 3.0 | 35.5 | 16.4 | 16.5 | 100 |
| 10J-S | 14 | 4.4 | 3.0 | 36.5 | 16.4 | 18.5 | 100 |
| 11J-S | 16 | 4.4 | 3.0 | 38.5 | 16.4 | 20.5 | 100 |
| 12J-S | 18 | 4.4 | 3.0 | 42.0 | 16.4 | 22.5 | 100 |



Bases con soporte a presión para bridas

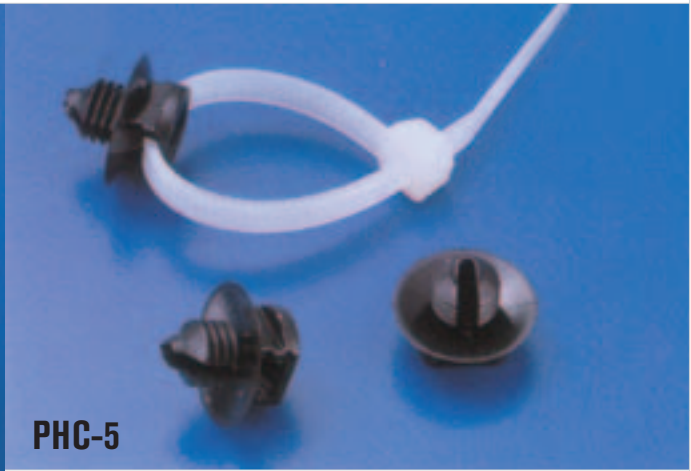

PHC-5

Material: Nylon 66 homologado (UL) 94V-2. Colores: Natural, negro.



PHC-4,-8

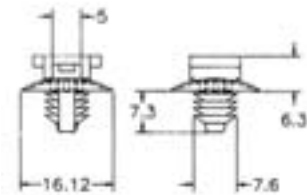

PHC-5

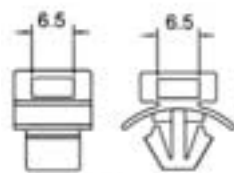

PHC-6.5

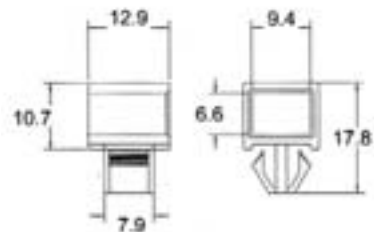

PHC-9

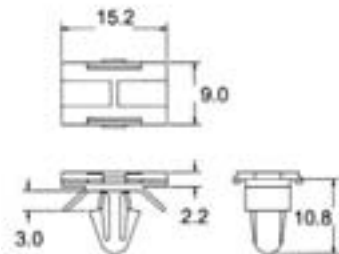

PHC-1509

| Ref. | T mm. | Ø Taladro mm. | |
|---|-------|---------------|-----|
| <input type="checkbox"/> PHC-4 | 4.0 | 4.8 | 100 |
| <input type="checkbox"/> PHC-6.5 | 6.5 | 8.5 | 100 |
| <input type="checkbox"/> PHC-8 | 8.1 | 6.2 | 100 |
| <input type="checkbox"/> PHC-9 | 9.4 | 7.9 | 100 |
| <input type="checkbox"/> PHC-1509 | 15.2 | 4.5 | 100 |
| <input type="checkbox"/> PHC-5 | 5 | 7.6 | 100 |
| <input checked="" type="checkbox"/> PHC-4-1 | 4.0 | 4.8 | 100 |
| <input checked="" type="checkbox"/> PHC-6.5-1 | 6.5 | 8.5 | 100 |
| <input checked="" type="checkbox"/> PHC-8-1 | 8.1 | 6.2 | 100 |
| <input checked="" type="checkbox"/> PHC-9-1 | 9.4 | 7.9 | 100 |
| <input checked="" type="checkbox"/> PHC-1509-1 | 15.2 | 4.5 | 100 |
| <input checked="" type="checkbox"/> PHC-5-1 | 5 | 7.6 | 100 |



Abrazaderas ajustables a presión

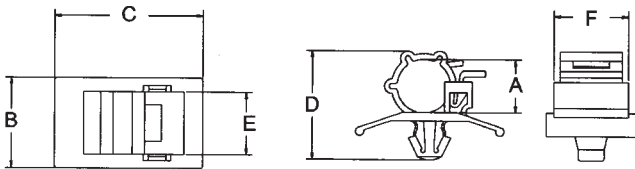

Taladro: 6,4 mm.

Material: Nylon 66 homologado UL 94V-2. Color: ■ Gris.

| Ref. | Dimensiones mm. | | | | | | |
|---------------|-----------------|------|------|------|------|------|-----|
| | A | B | C | D | E | F | |
| PFS-10 | 10.1 | 17.2 | 28.4 | 20.7 | 11.9 | 14.3 | 100 |
| PFS-15 | 14.9 | 19.3 | 31.8 | 27.1 | 14 | 16.3 | 100 |
| PFS-18 | 17.3 | 21.2 | 35 | 29 | 15.9 | 18.3 | 100 |

Abrazaderas ajustables con soporte adhesivo

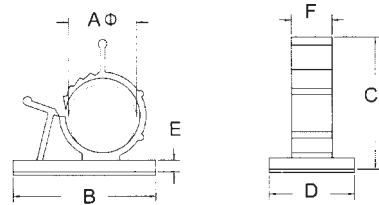
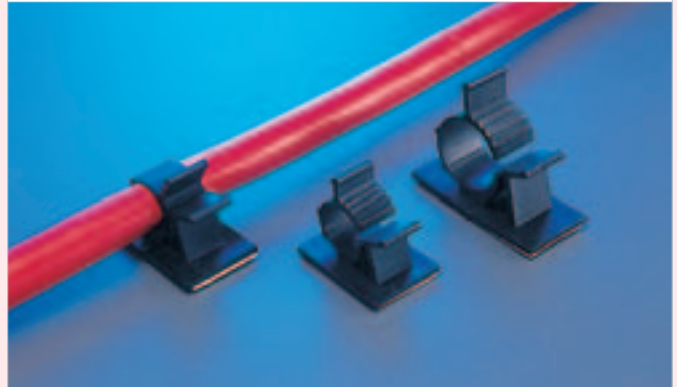

Base adhesiva

Material: Nylon 66 homologado UL 94V-2. Acabado con adhesivo en la base. Color: ■ Negro. Una sola referencia puede agrupar varias medidas de cable (gran ahorro de almacenaje). Fácil de instalar, abrir y cerrar para uso ilimitado.

| Ref. | Dimensiones mm. | | | | | | |
|----------------|-----------------|------|------|------|-----|------|-----|
| | A Ø | B | C | D | E | F | |
| AP-0810 | 7.9-10.3 | 25.4 | 22.2 | 19.1 | 1.6 | 10.2 | 100 |
| AP-1013 | 10.0-12.5 | 31.8 | 27.8 | 19.1 | 1.6 | 10.2 | 100 |
| AP-1316 | 12.6-15.4 | 38.1 | 31.8 | 19.1 | 1.6 | 12.7 | 100 |
| AP-1720 | 16.5-20.1 | 42 | 44.5 | 25.4 | 1.6 | 12.7 | 100 |
| AP-2225 | 22.2-25.4 | 42 | 44.5 | 25.4 | 1.6 | 12.7 | 100 |

Abrazadera de sujeción ajustable

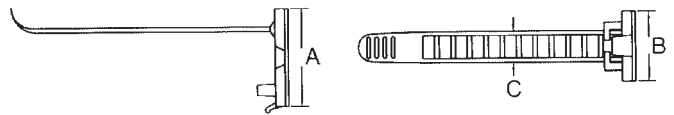

Base adhesiva

Material: Nylon 66 homologado UL 94V-2. Color: □ Natural.

| Ref. | Dimensiones mm. | | | | Ø Máx. Uso mm. | |
|---------------|-----------------|------|------|-----|----------------|-----|
| | A | B | C | L | | |
| ATC-17 | 25.0 | 18.0 | 7.9 | 70 | 17.0 | 100 |
| ATC-22 | 30.5 | 21.0 | 12.0 | 90 | 22.0 | 100 |
| ATC-26 | 30.5 | 21.0 | 12.0 | 108 | 26.0 | 100 |



Abrazaderas ajustables con soporte adhesivo y a presión

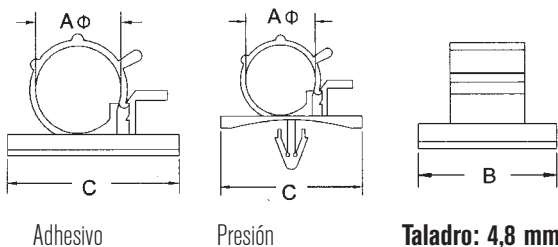
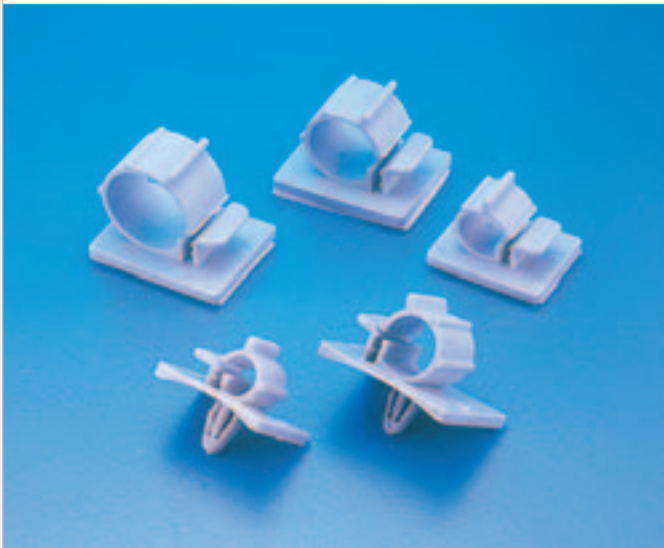

Material: Nylon 66 homologado (UL) 94V-2. Con dos posiciones de cierre que permiten agrupar varias medidas de cables. Disponible con autoadhesivo o para montaje a presión. Color: ■ Gris.

| Ref. Adhesivo | Ref. Presión | Dimensiones mm. | | | 📦 |
|------------------|-----------------|-----------------|------|----|-----|
| | | A Ø | B | C | |
| TS-0607 | PTS-0607 | 6-7 | 20 | 25 | 100 |
| TS-0708 | PTS-0708 | 7-8 | 20 | 25 | 100 |
| TS-0910 | PTS-0910 | 9-10 | 24.5 | 30 | 100 |
| TS-1214 | PTS-1214 | 12-14 | 24.5 | 30 | 100 |
| TS-1618 | PTS-1618 | 16-18 | 24.5 | 30 | 100 |

Clip sujetacables

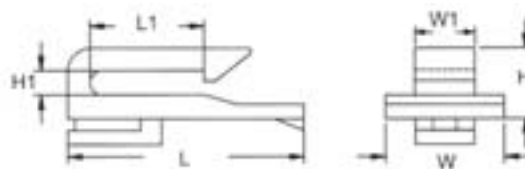
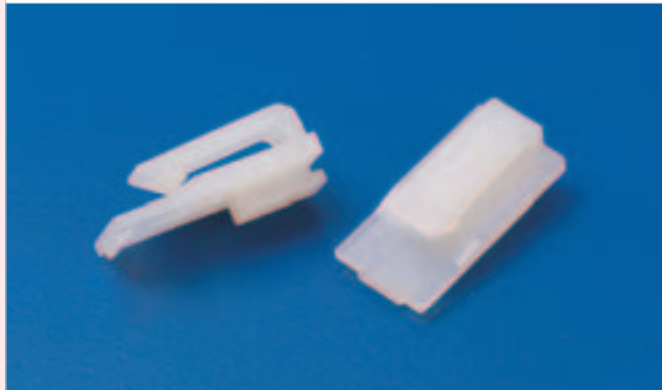

Material: Nylon 66 homologado (UL) 94V-2. Color: □ Natural.

| Ref. | Dimensiones mm. | | | | | | 📦 |
|-----------------|-----------------|-----|------|-----|---|-----|-----|
| | L | L1 | W | W1 | H | H1 | |
| MFC-1002 | 20.2 | 9.8 | 10.2 | 5.2 | 6 | 2.2 | 100 |

Clip sujetacables

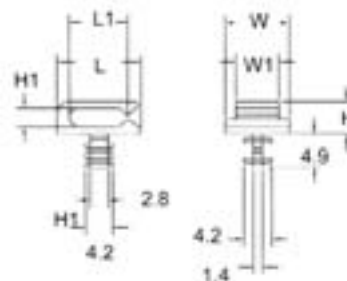

Material: Nylon 66 homologado (UL) 94V-2. Color: □ Natural.

| Ref. | Dimensiones mm. | | | | | | 📦 |
|----------------|-----------------|-----|-----|-----|---|-----|-----|
| | L | L1 | W | W1 | H | H1 | |
| FC-0903 | 12.8 | 8.9 | 9.8 | 6.6 | 5 | 2.8 | 100 |



Clips autoadhesivos para soporte de cables



Material: Nylon 66 homologado (UL) 94V-2. Acabado con soporte adhesivo.
 Color: □ Natural. Para aplicar en superficies limpias, lisas y sin grasas.
 Diseñadas para el soporte de cables ligeros.

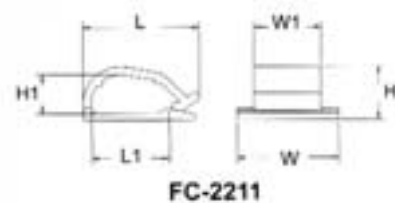
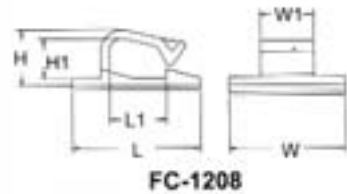
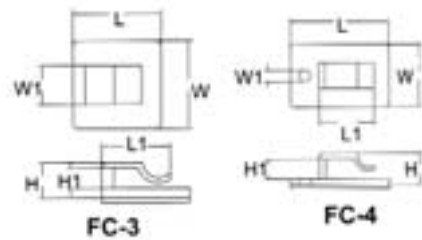
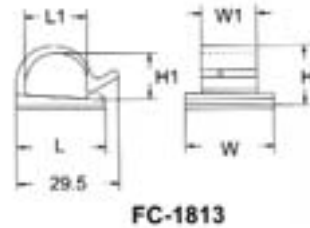
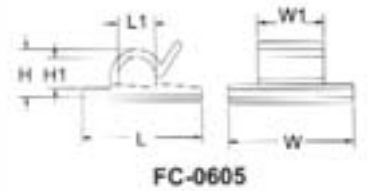
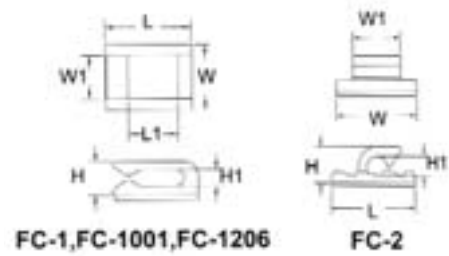
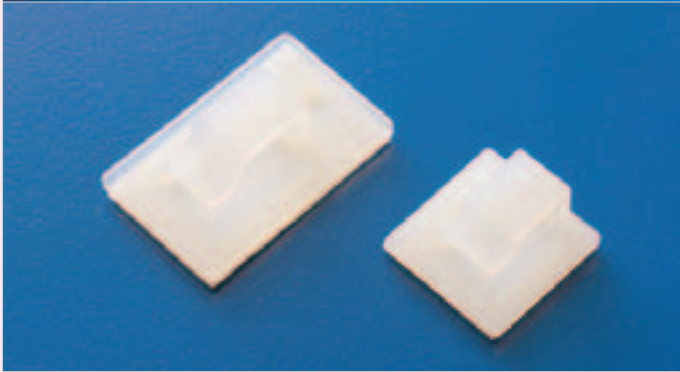

| Ref. | Dimensiones mm. | | | | | | |
|----------------|-----------------|------|------|------|------|------|-----|
| | L | L1 | W | W1 | H | H1 | |
| FC-1 | 13 | 9 | 9.5 | 6.5 | 5.2 | 2.8 | 100 |
| FC-2 | 16 | 4.0 | 15.5 | 9 | 6.8 | 4.0 | 100 |
| FC-3 | 16 | 12.5 | 16 | 8.8 | 8.7 | 3.7 | 100 |
| FC-4 | 27 | 14.8 | 17 | 3.1 | 8.7 | 5.5 | 100 |
| FC-0605 | 19 | 5.9 | 19 | 10 | 7.2 | 4.9 | 100 |
| FC-1001 | 11.9 | 9.3 | 6.0 | = | 3.5 | 1.0 | 100 |
| FC-1206 | 16 | 11.9 | 15.8 | 8.9 | 9 | 5.8 | 100 |
| FC-1208 | 26.8 | 11.9 | 26.5 | 12.3 | 11.7 | 8.3 | 100 |
| FC-1813 | 25.6 | 17.8 | 25.5 | 15.8 | 17.2 | 13.3 | 100 |
| FC-2211 | 32.5 | 22.2 | 28.3 | 18.7 | 15.2 | 11.1 | 100 |



Clip sujetacables

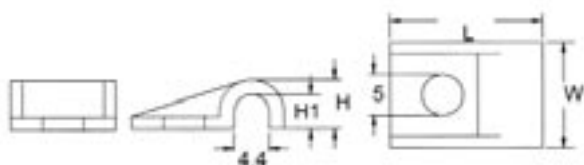

Material: Nylon 66 homologado (UL) 94V-2. Color: Natural.

| Ref. | Dimensiones mm. | | | | |
|-------------|-----------------|------|---|-----|-----|
| | L | W | H | H1 | |
| WH-4 | 18.7 | 12.8 | 6 | 4.4 | 100 |

Grapa sujetacables

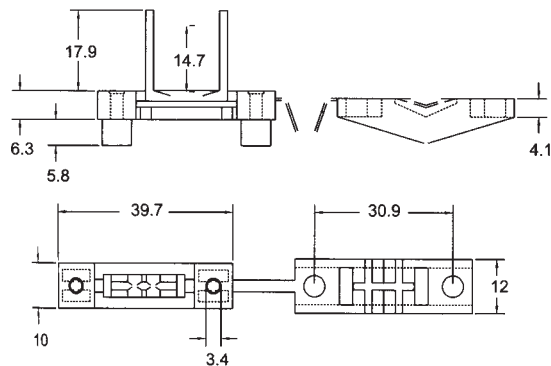

Material: Nylon 66 homologado (UL) 94V-2. Color: Natural.

| Ref. | Dimensiones | |
|------|-------------|--|
| | | |

Clip autoadhesivo para soporte de cables

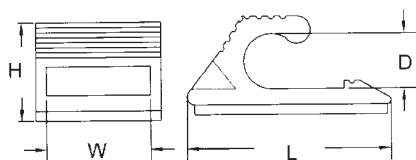
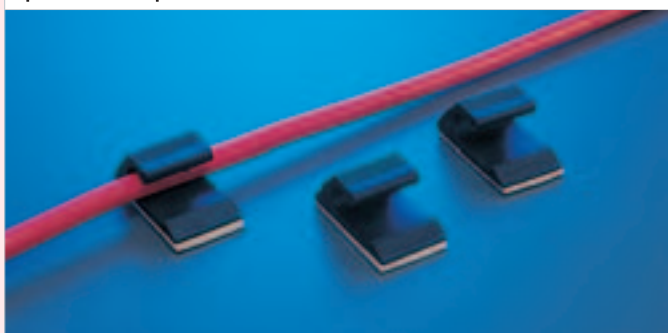

Base adhesiva

Material: Nylon 66 homologado (UL) 94V-2. acabado con adhesivo en la base. Diseñado especialmente para la instalación y soporte de cables tipo RG-59/(u). Color: Negro.

| Ref. | Dimensiones mm. | | | | |
|---------------|-----------------|------|------|-----|-----|
| | D | L | W | H | |
| CATV-1 | 6.3 | 21.1 | 12.8 | 9.2 | 100 |

Clips autoadhesivos para soporte de cables

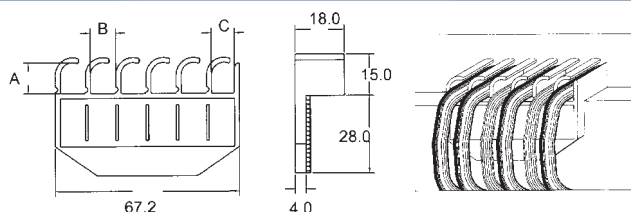
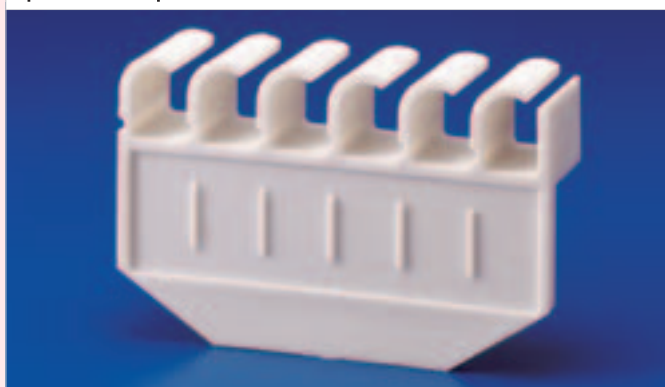

Material: Nylon 66 homologado (UL) 94V-2. Color: Blanco.

| Ref. | Dimensiones mm. | | | |
|----------------|-----------------|-----|-----|-----|
| | A | B | C | |
| SWC-610 | 11.0 | 9.2 | 8.4 | 100 |



Abrazadera de sujeción

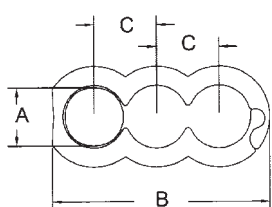
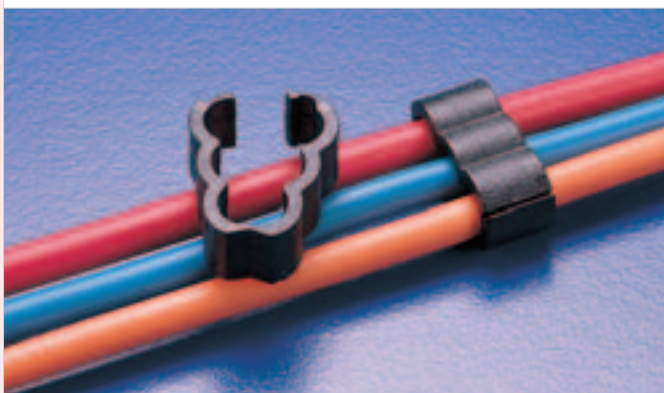

Material: Nylon 66 homologado (UL) 94V-2. Color: ■ Negro.

| Ref. | Dimensiones mm. | | | |
|--------------|-----------------|------|-----|-----|
| | A | B | C | |
| RC-34 | 4.1 | 14.3 | 4.1 | 100 |

Clips autoadhesivos para sujeción de cables planos

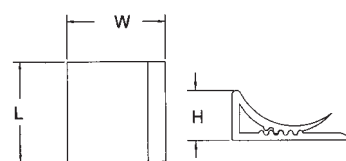

FC AUTOADHESIVO

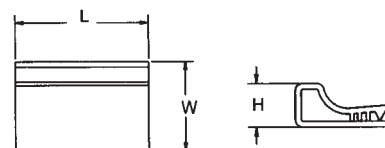

SFC AUTOADHESIVO

Material: PVC con soporte adhesivo. Color: ■ Gris.
Para soporte, correcta y ordenada conducción de cables planos.

| Ref. | Dimensiones mm. | | | |
|---------------|-----------------|----|----|-----|
| | L | W | H | |
| FC-15 | 15 | 25 | 10 | 100 |
| FC-20 | 20 | 25 | 10 | 100 |
| FC-25 | 25 | 25 | 10 | 100 |
| FC-28 | 28 | 25 | 10 | 100 |
| SFC-15 | 15 | 13 | 6 | 100 |
| SFC-20 | 20 | 13 | 6 | 100 |
| SFC-25 | 25 | 13 | 6 | 100 |
| SFC-28 | 28 | 13 | 6 | 100 |

Clip autoadhesivo

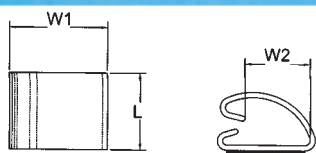
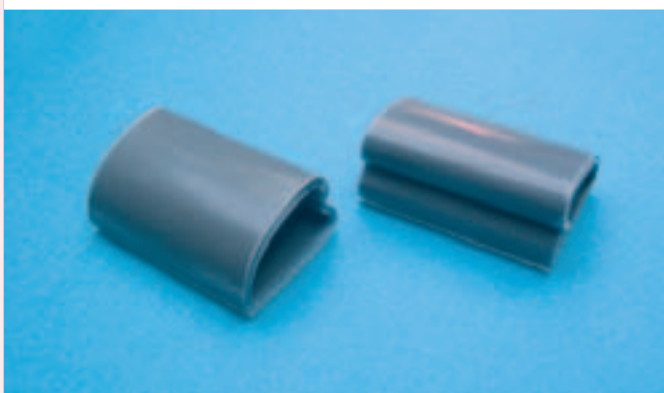

Material: PVC con soporte adhesivo. Color: ■ Gris.

| Ref. | Dimensiones mm. | | | |
|--------------|-----------------|------|------|-----|
| | L | W1 | W2 | |
| CL-15 | 15 | 18.5 | 16.0 | 100 |
| CL-20 | 20 | 18.5 | 16.0 | 100 |
| CL-25 | 25 | 18.5 | 16.0 | 100 |
| CL-28 | 28 | 18.5 | 16.0 | 100 |



Clips autoadhesivos y a presión para sujeción de cables planos



AUTOADHESIVO

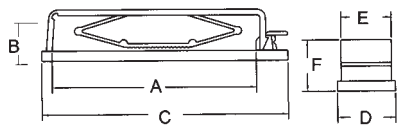

FCT-30,40,50

AUTOADHESIVO

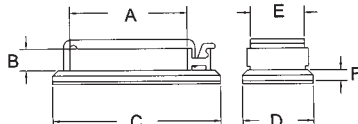

FC-30,40,50

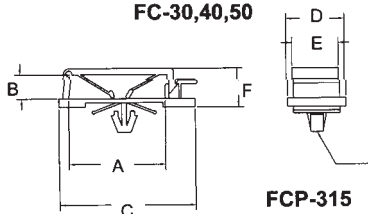

FCP-315

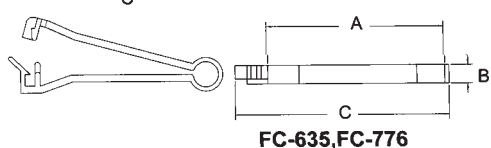

FC-635,FC-776

Material: Nylon 66 homologado (UL) 94V-2. Color: Natural.
El cable se sujeta con una simple presión sobre el cierre.

| Ref. | Dimensiones mm. | | | | | | Para cable | |
|----------------|-----------------|------|------|------|------|------|------------|-----|
| | A | B | C | D | E | F | | |
| FC-30 | 32.0 | 6.2 | 45.8 | 19.8 | 14.9 | 2.8 | - | 100 |
| FC-40 | 39.5 | 6.2 | 53.3 | 19.2 | 14.8 | 2.6 | - | 100 |
| FC-50 | 63.5 | 6.0 | 77.5 | 19.8 | 14.9 | 2.8 | 50 PIN | 100 |
| FCT-30 | 31.8 | 11.3 | 45.1 | 18.5 | 16 | 16.3 | 30 PIN | 100 |
| FCT-40 | 54 | 11.3 | 67 | 15.7 | 12 | 16.3 | 40 PIN | 100 |
| FCT-50 | 65 | 11.3 | 78.4 | 18.6 | 15.8 | 16.3 | 50 PIN | 100 |
| FC-635 | 63.5 | 6.4 | 76.2 | - | - | - | 50 PIN | 100 |
| FC-776 | 77.6 | 6.4 | 92.7 | - | - | - | 60 PIN | 100 |
| FCP-315 | 31.4 | 7.6 | 44.7 | 19.1 | 15.2 | 12.4 | 30 PIN | 100 |

Clip metálico adhesivo

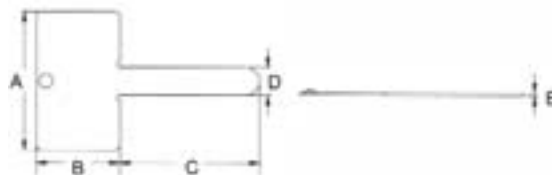
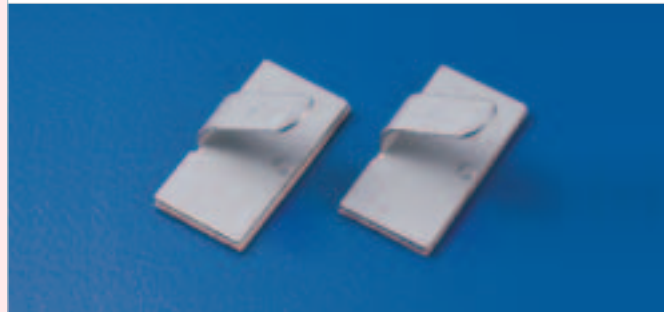

Clip metálico con soporte adhesivo. Para aplicar en superficies limpias, lisas y sin grasas. Diseñados para el soporte de cables. Color: Gris.

| Ref. | Dimensiones mm. | | | | | |
|---------------|-----------------|------|------|-----|-----|-----|
| | A | B | C | D | E | |
| MWC-15 | 19.4 | 10.0 | 15.0 | 5.0 | 0.5 | 100 |
| MWC-25 | 25.0 | 15.0 | 25.0 | 5.0 | 0.5 | 100 |

Abrazadera metálica



Material: Acero forrado de PVC.
Cabezal redondo para sujeción por tornillo o remache. Color: Negro.

| Ref. | Ref. | Dimensiones mm. | | | |
|-----------------|--------------------|-----------------|-----|------|-----|
| | | A | B | C | |
| TUBO PVC | FORRADO PVC | | | | |
| CW3-32 | CWC3-32 | 7.5 | 3.3 | 32.1 | 100 |
| CW3-52 | CWC3-52 | 7.5 | 3.3 | 52.1 | 100 |
| CW3-60 | CWC3-60 | 8.0 | 3.6 | 62.1 | 100 |
| CW4-35 | CWC4-35 | 8.5 | 4.2 | 35.2 | 100 |
| CW4-50 | CWC4-50 | 8.0 | 4.2 | 52.2 | 100 |
| CW4-75 | CWC4-75 | 7.5 | 4.2 | 74.5 | 100 |
| CW4-78 | CWC4-78 | 8.0 | 4.2 | 78.5 | 100 |
| CW5-70 | CWC5-70 | 8.5 | 5.1 | 69.3 | 100 |
| CW6-78 | CWC6-78 | 10.0 | 6.0 | 78.0 | 100 |



PRENSAESTOPAS
RACORES, TUBOS FLEXIBLES...



Prensaestopas de NYLON

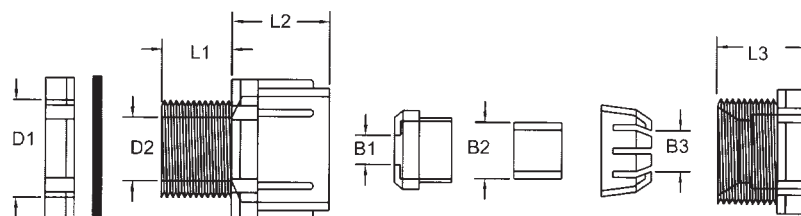

| Ref. | Orificio de montaje | | Dimensiones mm. | | | | | | | Para cable | |
|--------------|---------------------|------|-----------------|----|----|----|----|------|------|------------|----|
| | D1 | Paso | D2 | B1 | B2 | B3 | L1 | L2 | L3 | | |
| PG-16 | 16 | 1.5 | 10.5 | | 7 | 10 | 12 | 17 | 16.5 | 5-10 | 50 |
| PG-20 | 20 | 1.5 | 13.7 | | 9 | 13 | 13 | 19 | 19.5 | 6-13 | 50 |
| PG-25 | 25 | 1.5 | 18.5 | | 11 | 17 | 13 | 22 | 21 | 10-18 | 50 |
| PG-32 | 32 | 1.5 | 25 | | 15 | 20 | 15 | 24.5 | 24.5 | 16-22 | 25 |
| PG-40 | 40 | 1.5 | 32 | 22 | 27 | 31 | 21 | 26.5 | 27.5 | 20-27 | 10 |
| PG-50 | 50 | 1.5 | 41.5 | 32 | 36 | 41 | 23 | 30 | 31 | 30-41 | 10 |
| PG-63 | 63 | 1.5 | 53.2 | 43 | 43 | 51 | 25 | 33 | 33 | 40-53 | 10 |

Material: Nylon 66 homologado (UL) 94V-2.

Color: ■ Negro.

Aislante y resistente al agua y a los golpes.

Para protección y fijación de cables en paneles.

Aplicación:

1. montar y fijar el cuerpo en el orificio del panel.
2. insertar los cables a través del cuerpo y las piezas de fijación y cierre.
3. apretar la tuerca de fijación para mantener el cable en posición.

Prensaestopas de NYLON con protector de cable

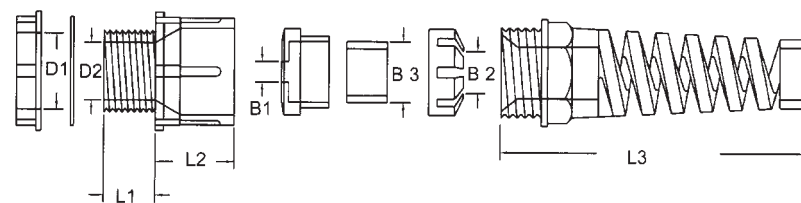

| Ref. | Orificio de montaje | | Dimensiones mm. | | | | | | | Para cable | |
|----------------|---------------------|------|-----------------|-----|----|----|----|----|----|------------|----|
| | D1 | Paso | D2 | B1 | B2 | B3 | L1 | L2 | L3 | | |
| PG-1610 | 16 | 1.5 | 10.9 | 4.8 | 7 | 10 | 12 | 17 | 62 | 5-10 | 50 |
| PG-2013 | 20 | 1.5 | 14.1 | 5.1 | 9 | 13 | 13 | 19 | 78 | 6-13 | 50 |

Material: Nylon 66 homologado (UL) 94V-2.

Color: ■ Negro.



Prensaestopas de NYLON con protector de cable E 186042



Material: Nylon 66 homologado  94V-2.

Color: ■ Negro.

| Ref. | Orificio de montaje D1 | Dimensiones mm. | | | | | | Para cable |  |
|------------------|------------------------|-----------------|-------|-------|-------|-------|-------|------------|---|
| | | Paso | D2 | B1 | L1 | L2 | L3 | | |
| AG-12SR | 12 | 1.25 | 8.3 | 6.0 | 7.9 | 12.1 | 53.3 | 3-6.5 | 50 |
| AG-16SR | 16 | 1.5 | 10.9 | 9.6 | 14.4 | 14.4 | 74.9 | 5-10 | 50 |
| AG-20SR | 20 | 1.5 | 14.8 | 12.9 | 12.8 | 19.5 | 96.2 | 10-14 | 50 |
| AG-25SR | 25 | 1.5 | 18.5 | 16.5 | 13.9 | 19.5 | 111.2 | 13-18 | 25 |
| EG-7SR | 11.7 | 1.5 | 8.0 | 6.0 | 8.0 | 12.8 | 53.3 | 3.5-6 | 50 |
| EG-9SR | 14.3 | 1.5 | 9.9 | 7.0 | 8.1 | 13.9 | 62.5 | 4-8 | 50 |
| EG-11SR | 17.3 | 1.5 | 13.2 | 9.6 | 8.2 | 15.4 | 74.9 | 5-10 | 50 |
| EG-13.5SR | 19.3 | 1.5 | 15.2 | 11.7 | 8.9 | 15.8 | 85.5 | 6-12 | 50 |
| EG-16SR | 21.3 | 1.5 | 17.2 | 12.9 | 8.9 | 17.3 | 96.2 | 10-14 | 50 |
| EG-21SR | 27 | 1.5 | 22.4 | 16.5 | 10.8 | 18.6 | 111.2 | 13-18 | 25 |
| AGJ-14SR | 14 | 1.5 | 8.04 | 6.33 | 8.07 | 12.15 | 53.3 | 3-6.5 | 50 |
| AGJ-17SR | 17 | 1.5 | 10.76 | 10.25 | 14.63 | 14.53 | 74.9 | 5-10 | 50 |
| AGJ-21SR | 21 | 1.5 | 14.98 | 13.5 | 12.87 | 19.6 | 96.2 | 10-14 | 50 |
| AGJ-27SR | 27 | 1.5 | 18.37 | 18.65 | 14.66 | 18.45 | 111.2 | 13-18 | 25 |

Prensaestopas de NYLON E 186042

IP68



Sistema métrico

| Ref. | Orificio de montaje D1 | Dimensiones mm. | | | | | | Para cable |  |
|---------------|------------------------|-----------------|------|------|------|------|------|------------|---|
| | | Paso | D2 | B1 | L1 | L2 | L3 | | |
| AG-12 | 12 | 1.25 | 8.3 | 6.0 | 7.9 | 12.1 | 13.3 | 3-6.5 | 50 |
| AG-16 | 16 | 1.5 | 10.9 | 9.6 | 15.7 | 14.4 | 16.7 | 5-10 | 50 |
| AG-20 | 20 | 1.5 | 14.8 | 12.9 | 15.0 | 19.5 | 18.4 | 10-14 | 50 |
| AG-25 | 25 | 1.5 | 18.6 | 16.4 | 15.0 | 18.7 | 22.3 | 13-18 | 50 |
| AG-32 | 32 | 1.5 | 26 | 23.4 | 14.7 | 20.3 | 26.2 | 18-25 | 25 |
| AG-40 | 40 | 1.5 | 33 | 30.6 | 17.7 | 23.4 | 31.9 | 22-32 | 10 |
| AG-50 | 50 | 1.5 | 41.2 | 38.2 | 17.3 | 25.7 | 31.6 | 30-38 | 10 |
| AG-16F | 20.8 | PF1/2" | 11 | 13 | 9.5 | 14.0 | 18.7 | 5-10 | 50 |
| AG-20F | 20.8 | 14 | 14.7 | 14.7 | 9.5 | 16.0 | 18.5 | 6-13 | 50 |

Sistema JIS

| Ref. | Orificio de montaje D1 | Dimensiones mm. | | | | | | Para cable |  |
|---------------|------------------------|-----------------|-------|-------|-------|-------|------|------------|---|
| | | Paso | D2 | B1 | L1 | L2 | L3 | | |
| AGJ-14 | 14 | 1.5 | 8.04 | 6.33 | 8.07 | 12.15 | 13.3 | 3-6.5 | 50 |
| AGJ-17 | 17 | 1.5 | 10.76 | 10.25 | 14.63 | 14.53 | 16.7 | 5-10 | 50 |
| AGJ-21 | 21 | 1.5 | 14.98 | 13.50 | 12.87 | 19.60 | 18.4 | 10-14 | 50 |
| AGJ-27 | 27 | 1.5 | 18.37 | 18.65 | 14.66 | 18.45 | 22.3 | 13-18 | 50 |
| AGJ-34 | 34 | 1.5 | 25.84 | 25.31 | 14.84 | 20.75 | 26.1 | 18-25 | 25 |

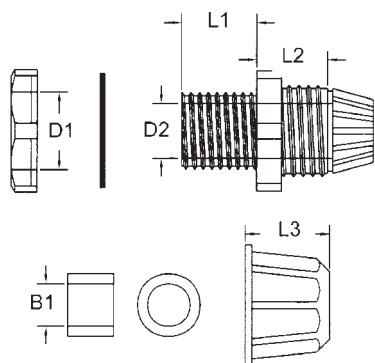

Material: Nylon 66 homologado  94 V-2.

Color standard: ■ -GR.

Otros colores: ■ -AZ, □ -BL, ■ -GC, ■ -IV,

■ -NG.

5 Prensaestopas, racores, tubos flexibles...



Pasacables adaptables



| Ref. | Dimensiones mm. | | | | | | |
|-------------|-----------------|------|------|----|----|----|----|
| | A | B | C | D | E | F | |
| KB-1 | 19 | 13 | 14 | 6 | 8 | 10 | 50 |
| KB-2 | 22 | 17.5 | 16.6 | 10 | 13 | 15 | 50 |

Material: PVC. Color: ■ Negro.

Basta eliminar las piezas opcionales no necesarias para la adaptación a los diferentes diámetros de cable.

Se utiliza para la fijación y protección de cables.

Prensaestopas de NYLON E 186042

IP68

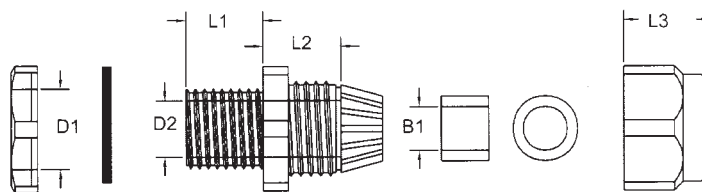

| Ref. | Orificio de montaje D1 | Dimensiones mm. | | | | | | | Para cable | |
|-----------------|------------------------|-----------------|-----|------|------|-------|------|------|------------|----|
| | | Paso | D2 | B1 | L1 | L2 | L3 | | | |
| EG-7 | PG-7 | 12.1 | 1.5 | 8.0 | 6.0 | 8.0 | 12.8 | 13.4 | 3.5-6 | 50 |
| EG-7LS | PG-7 | MÁS PEQUEÑO | 1.5 | 8.0 | 6.0 | 8.0 | 12.8 | 13.4 | 3.5-6 | 50 |
| EG-9 | PG-9 | 14.3 | 1.5 | 9.9 | 7.0 | 8.1 | 13.9 | 15.2 | 4-8 | 50 |
| EG-9L | PG-9 | | 1.5 | 9.9 | 7.0 | 14.67 | 13.9 | 15.2 | 4-8 | 50 |
| EG-11 | PG-11 | 18.23 | 1.5 | 13.2 | 9.6 | 8.2 | 15.4 | 18.3 | 5-10 | 50 |
| EG-11L | PG-11 | | 1.5 | 13.2 | 9.6 | 14.85 | 15.4 | 18.3 | 5-10 | 50 |
| EG-13.5 | PG-13.5 | 19.9 | 1.5 | 15.2 | 11.7 | 8.9 | 15.8 | 18.9 | 6-12 | 50 |
| EG-13.5L | PG-13.5 | | 1.5 | 15.2 | 11.7 | 15.63 | 15.8 | 18.9 | 6-12 | 50 |
| EG-16 | PG-16 | 22.1 | 1.5 | 17.2 | 12.9 | 8.9 | 17.3 | 19.7 | 10-14 | 50 |
| EG-21 | PG-21 | 27.5 | 1.5 | 22.4 | 16.5 | 10.8 | 18.6 | 23.9 | 13-18 | 50 |
| EG-29 | PG-29 | 36.2 | 1.5 | 30.6 | 23.3 | 10.9 | 20.5 | 27.4 | 18-25 | 25 |
| EG-36 | PG-36 | 46.7 | 1.5 | 35.2 | 33.3 | 14.4 | 24.4 | 30.5 | 22-32 | 10 |
| EG-42 | PG-42 | 52.2 | 1.5 | 39.3 | 39.6 | 14.6 | 25.4 | 31.6 | 30-38 | 10 |
| EG-48 | PG-48 | 57.6 | 1.5 | 45.4 | 45.1 | 15.8 | 25.2 | 31.3 | 34-44 | 10 |

Sistema PG. Standard DIN. Sin arandela

5 Prensaestopas, racores, tubos flexibles...

Material: Nylon 66 homologado (UL) 94 V-2.

Color standard: ■ -GR.

Otros colores: ■ -AZ, □ -BL, ■ -GC, ■ -IV, ■ -NG.



Arandelas reductoras



Material: Nylon 66 homologado \odot 94V-2.

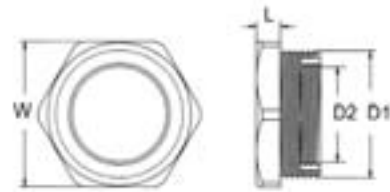

| Ref. | Dimensiones mm. | | L | W | |
|--------------|-----------------|-----------|------|------|-----|
| | D1 | D2 | | | |
| M2012 | M20 x 1.5 | M12 x 1.5 | 8.0 | 24.2 | 100 |
| M2016 | M20 x 1.5 | M16 x 1.5 | 8.0 | 24.2 | 100 |
| M2516 | M25 x 1.5 | M16 x 1.5 | 8.0 | 29.0 | 100 |
| M2520 | M25 x 1.5 | M20 x 1.5 | 8.0 | 29.0 | 100 |
| M3220 | M32 x 1.5 | M20 x 1.5 | 10.0 | 35.9 | 50 |
| M3225 | M32 x 1.5 | M25 x 1.5 | 10.0 | 35.9 | 50 |
| M4032 | M40 x 1.5 | M32 x 1.5 | 10.0 | 45.8 | 25 |
| M5040 | M50 x 1.5 | M40 x 1.5 | 11.5 | 55.0 | 25 |
| M6350 | M63 x 1.5 | M50 x 1.5 | 11.5 | 67.5 | 25 |

Prensaestopas de NYLON

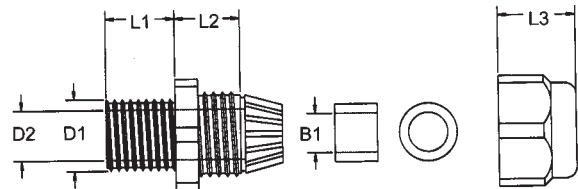

Material: Nylon 66 homologado \odot 94 V-2.

Color: ■ Negro.

| Ref. | Orificio de montaje D1 | Dimensiones mm. Paso | Dimensiones mm. | | | | | Para cable | |
|----------------|------------------------|----------------------|-----------------|------|------|------|------|------------|----|
| | | | D2 | B1 | L1 | L2 | L3 | | |
| NPT-14 | 13.2 | NPT 1/4" | 8.3 | 6.0 | 7.6 | 12.7 | 13.2 | 3-6.5 | 25 |
| NPT-38 | 16.4 | NPT 3/8" | 10.7 | 9.0 | 14.6 | 13.7 | 16.8 | 5-10 | 25 |
| NPT-12 | 20.7 | NPT 1/2" | 14.9 | 12.7 | 12.5 | 18.8 | 18.4 | 10-14 | 25 |
| NPT-34 | 25.6 | NPT 3/4" | 18.5 | 16.5 | 14.6 | 17.8 | 22.3 | 13-18 | 25 |
| NPT-1 | 33.0 | NPT 1" | 26.0 | 23.7 | 14.7 | 20.6 | 27.2 | 18-25 | 25 |
| NPT-114 | 41.7 | NPT 1 1/4" | 32.0 | 29.0 | 17.9 | 22.4 | 31.4 | 22-32 | 10 |



Prensaestopas de NYLON en ángulo recto

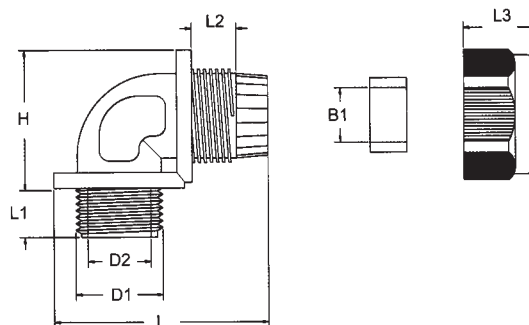

Material: Nylon 66 homologado \odot 94 V-2. Color: ■ Negro.

| Ref. | Orificio de montaje D1 | Paso | Dimensiones mm. | | | L1 | L2 | L3 | L | H | Para cable | |
|-----------------|------------------------|------------|-----------------|------|------|-------|------|------|------|-------|------------|--|
| | | | D2 | B1 | | | | | | | | |
| NPTA-38 | 16.6 | NPT 3/8" | 12 | 9.3 | 11.7 | 9.85 | 16.7 | 48.5 | 30 | 5-9 | 20 | |
| NPTA-12 | 21 | NPT 1/2" | 14 | 13 | 14.7 | 11.75 | 18.4 | 51.6 | 31.2 | 10-13 | 20 | |
| NPTA-34 | 26.3 | NPT 3/4" | 19.2 | 16.4 | 14.8 | 12.55 | 22.3 | 64.5 | 41.6 | 13-16 | 20 | |
| NPTA-114 | 41.7 | NPT 1 1/4" | 31.6 | 29.3 | 18.8 | 16.25 | 31 | 85 | 53 | 22-29 | 10 | |

Protector "micro-switch"

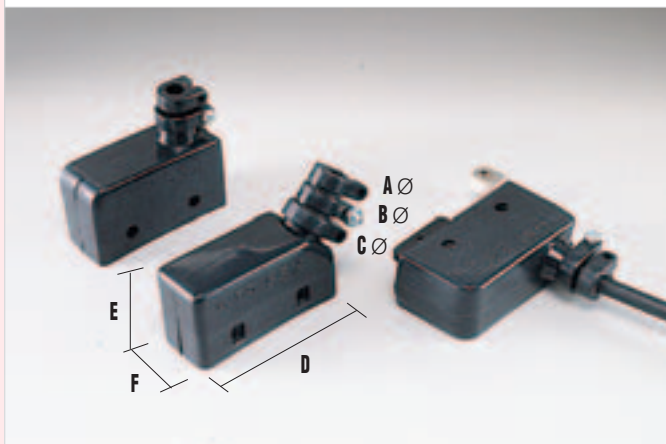

Material: PVC flexible. Color: ■ Negro.

Diseñado para la protección de micro-switch montados en maquinaria y de los cables contra posibles roturas. Disponibles en versión 45° y 90°.

| Ref. | Tipo | Dimensiones mm. | | | | | | |
|-------------|------|-----------------|-----|-----|----|----|----|----|
| | | A Ø | B Ø | C Ø | D | E | F | |
| CB-1 | 90° | 7 | 9 | - | 49 | 27 | 19 | 50 |
| CB-2 | 45° | 7 | 9 | 11 | 49 | 27 | 19 | 50 |

Adaptador para tubos flexibles

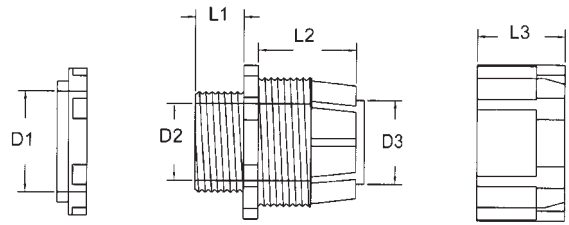

Material: Nylon 66 homologado UL 94V-2 . Color: ■ Gris. Construido en tres partes para la fijación de tubos flexibles en paneles de control, maquinaria, etc...
 Aplicación: 1. montar el cuerpo en el orificio del panel. 2. pasar el tubo a través de la tuerca de fijación. 3. insertar el tubo dentro de la grapa de sujeción y fijar con la tuerca para completar el montaje.

| Ref. | Dimensiones mm. | | | L1 | L2 | L3 | Para tubos | |
|--------------|-----------------|------|------|------|------|------|-----------------|----|
| | D1 | D2 | D3 | | | | | |
| BG-16 | 15.9 | 11.0 | 10.8 | 10.0 | 17.9 | 15.7 | BG-16P | 50 |
| BG-18 | 17.2 | 11.0 | 13.8 | 11.0 | 19.0 | 16.0 | BG-18P (3/8") | 50 |
| BG-20 | 19.2 | 15.0 | 14.7 | 10.0 | 17.7 | 16.0 | BG-20P | 50 |
| BG-22 | 20.6 | 14.8 | 17.2 | 11.0 | 19.0 | 16.0 | BG-22P (1/2") | 50 |
| BG-25 | 23.1 | 18.0 | 19.6 | 11.3 | 23.4 | 21.0 | BG-25P | 50 |
| BG-26 | 24.0 | 17.7 | 20.3 | 12.5 | 25.0 | 20.0 | BG-26P (3/4") | 50 |
| BG-32 | 31.2 | 26.0 | 24.3 | 12.0 | 22.8 | 20.6 | BG-32P | 25 |
| BG-34 | 32.5 | 25.8 | 28.7 | 12.5 | 25.0 | 21.0 | BG-34P (1") | 25 |
| BG-40 | 37.5 | 31.5 | 31.6 | 11.3 | 23.6 | 20.7 | BG-40P | 25 |
| BG-42 | 38.7 | 31.5 | 35.0 | 12.5 | 25.0 | 21.0 | BG-42P (1 1/4") | 25 |
| BG-48 | 44.0 | 37.5 | 40.5 | 12.6 | 22.3 | 20.7 | BG-48P | 10 |
| BG-50 | 44.0 | 37.5 | 39.5 | 12.6 | 21.6 | 20.7 | BG-50P | 10 |

Adaptador para tubos flexibles



Material: ABS. Color: ■ Gris.

| Ref. | Tipo | Para tubos | |
|---------------|----------------------|---------------|----|
| FAM-18 | Tubo flexible / | BG-18P (3/8") | 20 |
| FAM-22 | Tubo flexible | BG-22P (1/2") | 20 |
| FAM-26 | | BG-26P (3/4") | 20 |
| FAM-34 | | BG-34P (1") | 20 |
| FAP-18 | Tubo flexible / | BG-18P (3/8") | 20 |
| FAP-22 | Tubo rígido de PVC | BG-22P (1/2") | 20 |
| FAP-26 | | BG-26P (3/4") | 20 |
| FAP-34 | | BG-34P (1") | 20 |
| FAB-18 | Tubo flexible / | BG-18P (3/8") | 20 |
| FAB-22 | Caja de distribución | BG-22P (1/2") | 20 |
| FAB-26 | | BG-26P (3/4") | 20 |
| FAB-34 | | BG-34P (1") | 20 |



Adaptador "EASY TYPE" para tubos flexibles

PATENTADO



Material: Nylon 66 homologado (UL) 94V-2.

PATENTADO

| Ref. ■ gris | Ref. ■ negro | Para tubos | |
|-----------------|-------------------|------------|----|
| ■ BGQ-16 | ■ BGQ-16BK | BG-16P | 50 |
| ■ BGQ-18 | ■ BGQ-18BK | BG-18P | 50 |
| ■ BGQ-20 | ■ BGQ-20BK | BG-20P | 50 |
| ■ BGQ-22 | ■ BGQ-22BK | BG-22P | 50 |
| ■ BGQ-25 | ■ BGQ-25BK | BG-25P | 50 |
| ■ BGQ-26 | ■ BGQ-26BK | BG-26P | 50 |
| ■ BGQ-32 | ■ BGQ-32BK | BG-32P | 50 |
| ■ BGQ-34 | ■ BGQ-34BK | BG-34P | 50 |

Adaptador para tubos flexibles de metal



Material: ABS. Color: ■ Gris.

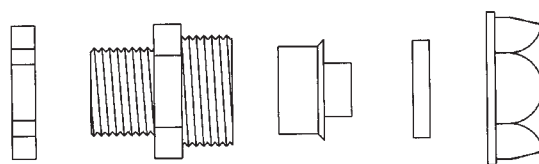

| Ref. | mm | Para tubos | |
|--------------|------|------------|----|
| MG-18 | 21.7 | 1/2" | 50 |
| MG-26 | 27.2 | 3/4" | 50 |
| MG-32 | 34.0 | 1" | 25 |
| MG-41 | 42.7 | 1 1/4" | 25 |



Tubo flexible cerrado de NYLON

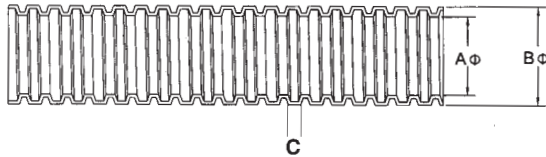

Material: NYLON. Color: ■ Negro.

Diseño cerrado. Para la protección de cables en maquinaria, construcción, etc. Su flexibilidad facilita la instalación de cableados.

| Ref. | Dimensiones mm. | | | |
|--------------|-----------------|----------|-----|-----|
| | Aφ | Bφ | C | |
| PA-07 | 6.6±0.4 | 10.0±0.4 | 2.4 | 50m |
| PA-10 | 9.8±0.4 | 13.0±0.4 | 2.0 | 50m |
| PA-12 | 12.2±0.4 | 15.8±0.4 | 2.1 | 50m |
| PA-17 | 16.8±0.4 | 21.7±0.4 | 2.3 | 50m |
| PA-23 | 23.0±0.4 | 28.5±0.4 | 2.3 | 50m |
| PA-29 | 28.6±0.4 | 34.4±0.4 | 2.5 | 50m |
| PA-36 | 35.8±0.5 | 42.5±0.5 | 2.0 | 25m |
| PA-48 | 47.5±0.5 | 54.5±0.5 | 2.0 | 25m |

Tubo flexible cerrado

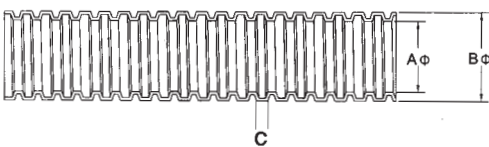

Material: PE ■ gris o NYLON ■ negro.

| Ref. PE Gris | Ref. NYLON Negro | Dimensiones mm. | | | |
|-----------------|---------------------|-----------------|----------|------|------|
| | | Aφ | Bφ | C | |
| ■ BG-10P | ■ BGN-10PBK | 7.4±0.4 | 10.2±0.4 | 2.64 | 300m |
| ■ BG-14P | ■ BGN-14PBK | 10.7±0.4 | 14.1±0.4 | 2.04 | 100m |
| ■ BG-16P | ■ BGN-16PBK | 10.7±0.4 | 16.0±0.4 | 3.30 | 100m |
| ■ BG-18P | ■ BGN-18PBK | 13.8±0.4 | 17.5±0.4 | 3.10 | 100m |
| ■ BG-20P | ■ BGN-20PBK | 14.1±0.4 | 20.0±0.4 | 3.70 | 100m |
| ■ BG-22P | ■ BGN-22PBK | 17.2±0.4 | 22.0±0.4 | 3.10 | 100m |
| ■ BG-25P | ■ BGN-25PBK | 18.3±0.4 | 25.0±0.4 | 4.10 | 100m |
| ■ BG-26P | ■ BGN-26PBK | 21.2±0.4 | 25.8±0.4 | 3.10 | 100m |
| ■ BG-32P | ■ BGN-32PBK | 24.3±0.4 | 32.0±0.4 | 3.61 | 50m |
| ■ BG-34P | ■ BGN-34PBK | 28.7±0.4 | 34.0±0.4 | 3.10 | 50m |
| ■ BG-40P | ■ BGN-40PBK | 31.2±0.4 | 40.0±0.4 | 4.12 | 50m |
| ■ BG-42P | ■ BGN-42PBK | 34.9±0.4 | 42.0±0.4 | 3.10 | 50m |
| ■ BG-48P | ■ BGN-48PBK | 40.0±0.5 | 48.0±0.5 | 2.85 | 50m |
| ■ BG-50P | ■ BGN-50PBK | 39.6±0.5 | 50.0±0.5 | 4.85 | 50m |
| ■ BG-60P | ■ BGN-60PBK | 52.0±0.5 | 60.0±0.5 | 5.80 | 50m |
| ■ BG-76P | ■ BGN-76PBK | 62.0±0.5 | 76.0±0.5 | 5.80 | 50m |
| ■ BG-89P | ■ BGN-89PBK | 80.0±0.5 | 89.0±0.5 | 5.80 | 50m |



Tubo flexible abierto y cerrado

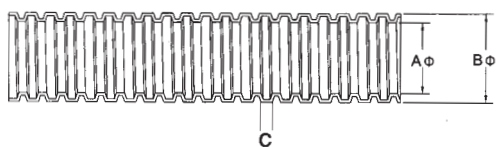

Material: Material: PE o NYLON.

Color: ■ Negro.

| Ref. PE Abierto | Ref. NYLON Cerrado | Dimensiones mm. | | | |
|---------------------------|------------------------------|-----------------|----------|------|------|
| | | A Ø | B Ø | C | |
| CR-1007P | CRS-1007P | 7.4±0.4 | 10.2±0.4 | 2.60 | 300m |
| CR-1011SP | CRS-1011SP | 10.7±0.4 | 14±0.4 | 1.10 | 200m |
| CR-1011P | CRS-1011P | 10.7±0.4 | 16.0±0.4 | 3.30 | 200m |
| CR-1013P | CRS-1013P | 13.8±0.4 | 17.5±0.4 | 3.10 | 200m |
| CR-1015P | CRS-1015P | 15.0±0.4 | 19.5±0.4 | 3.50 | 100m |
| CR-1017P | CRS-1017P | 17.2±0.4 | 22.0±0.4 | 3.10 | 100m |
| CR-1019P | CRS-1019P | 19.3±0.4 | 23.8±0.4 | 3.50 | 100m |
| CR-1022P | CRS-1022P | 21.2±0.4 | 25.8±0.4 | 3.10 | 100m |
| CR-1024P | CRS-1024P | 24.3±0.4 | 32.0±0.4 | 3.61 | 50m |
| CR-1025P | CRS-1025P | 25.0±0.4 | 30.0±0.4 | 4.10 | 50m |
| CR-1028P | CRS-1028P | 28.0±0.4 | 34.0±0.4 | 3.10 | 50m |
| CR-1032P | CRS-1032P | 31.2±0.4 | 40.0±0.4 | 4.12 | 50m |
| CR-1035P | CRS-1035P | 34.9±0.4 | 42.0±0.4 | 3.10 | 50m |
| CR-1040P | CRS-1040P | 39.6±0.5 | 50.0±0.5 | 4.85 | 50m |
| CR-1052P | CRS-1052P | 52.0±0.5 | 60.0±0.5 | 5.8 | 50m |
| CR-1062P | CRS-1062P | 62.0±0.5 | 76.0±0.5 | 5.8 | 50m |
| CR-1080P | CRS-1080P | 80.0±0.5 | 89.0±0.5 | 5.8 | 50m |

Tubo flexible cerrado, empotrable

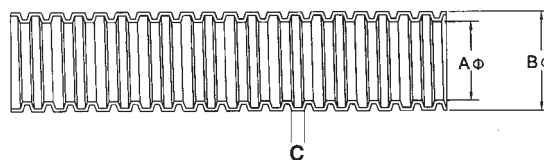

Material: H.D.P.E. Color: ■ Negro.

Aplicaciones: Para proteger los cables en instalaciones empotradas.

Diseño flexible para el mejor deslizamiento de los cables. **Diseño cerrado.**

| Ref. | Dimensiones mm. | | | |
|---------------|-----------------|----------|------|------|
| | A Ø | B Ø | C | |
| CF-14P | 10.7±0.4 | 14.1±0.4 | 2.04 | 100m |
| CF-18P | 13.8±0.4 | 17.5±0.4 | 3.2 | 100m |
| CF-22P | 17.2±0.4 | 22.0±0.4 | 3.2 | 100m |
| CF-26P | 21.2±0.4 | 25.8±0.4 | 3.2 | 100m |
| CF-34P | 28.7±0.4 | 34.0±0.4 | 3.2 | 50m |
| CF-42P | 34.9±0.4 | 42.0±0.4 | 3.2 | 50m |



Tubo metálico flexible

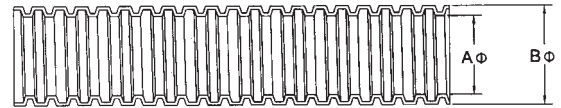

Material: P.V.C. Color: ■ Negro.

| Ref. | Dimensiones mm. | | Para cable |  |
|---------------|-----------------|-------|------------|---|
| | A Ø | B Ø | | |
| MCR-02 | 6.5 | 11.0 | NBG-02 | 100m |
| MCR-03 | 10.0 | 14.4 | NBG-03 | 50m |
| MCR-04 | 12.8 | 17.5 | NBG-04 | 50m |
| MCR-05 | 16.0 | 20.8 | NBG-05 | 50m |
| MCR-06 | 20.2 | 25.5 | NBG-06 | 50m |
| MCR-08 | 26.2 | 32.4 | NBG-08 | 25m |
| MCR-10 | 32.5 | 39.0 | NBG-10 | 25m |
| MCR-12 | 39.3 | 46.2 | NBG-12 | 25m |
| MCR-16 | 51.3 | 59.5 | NBG-16 | 25m |
| MCR-20 | 62.9 | 72.2 | NBG-20 | 10m |
| MCR-24 | 77.5 | 88.9 | NBG-24 | 1m |
| MCR-32 | 101.6 | 113.9 | NBG-32 | 1m |

¿Sabía qué...



...X.B. components, s.a. es una empresa con certificado ISO 9001:2000 expedido por Lloyd's Register en 1998?





**PASACABLES
Y PROTECTORES**



Cubre aristas adaptable

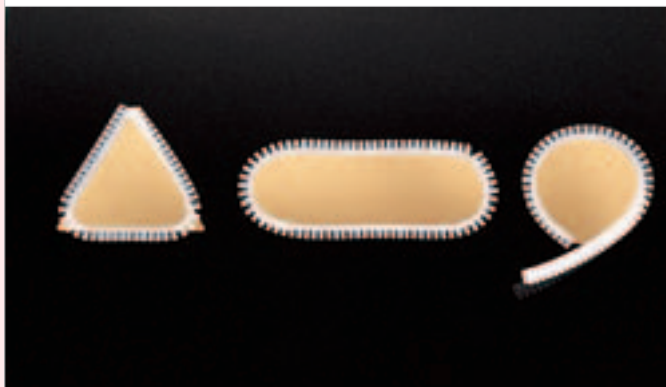

Material: PE fabricado por extrusión. Color: Natural.

Unidad de envase: 10 metros por rollo. Los rollos se presentan en una bolsa de plástico. Adaptables a cualquier tamaño de orificio, protege a los cables de los posibles daños ocasionados por las aristas de los paneles. Se suministra también en nylon moldeado y en piezas de 25 cm.



Envasado para serie KGH

| Ref. | Dimensiones mm. T | Grosor chasis | Material | |
|----------------|-------------------|---------------|----------|--------------|
| KG-008 | 0.8 | bajo 0.8 | PP | 10m/bolsa |
| KG-010 | 1.0 | 1.0 | PP | 10m/bolsa |
| KG-012 | 1.2 | 1.0-1.2 | PP | 10m/bolsa |
| KG-016 | 1.6 | 1.0-1.6 | PP | 10m/bolsa |
| KG-020 | 2.0 | 1.6-2.0 | PP | 10m/bolsa |
| KG-024 | 2.4 | 2.0-2.4 | PP | 10m/bolsa |
| KG-032 | 3.2 | 2.4-3.2 | PP | 10m/bolsa |
| KG-045 | 4.5 | 3.2-4.5 | PP | 10m/bolsa |
| KGH-008 | 0.8 | bajo 0.8 | PP | 100m/rollo |
| KGH-010 | 1.0 | 1.0 | PP | 100m/rollo |
| KGH-012 | 1.2 | 1.0-1.2 | PP | 100m/rollo |
| KGH-016 | 1.6 | 1.0-1.6 | PP | 100m/rollo |
| KGH-020 | 2.0 | 1.6-2.0 | PP | 100m/rollo |
| KGH-024 | 2.4 | 2.0-2.4 | PP | 100m/rollo |
| KGH-032 | 3.2 | 2.4-3.2 | PP | 100m/rollo |
| KGH-045 | 4.5 | 3.2-4.5 | PP | 100m/rollo |
| KG-010N | 1.0 | 1.0 | Nylon | |
| KG-016N | 1.6 | 1.0-1.6 | Nylon | |
| KG-020N | 2.0 | 1.6-2.0 | Nylon | 25cm/pieza |
| KG-024N | 2.4 | 2.0-2.4 | Nylon | 100pcs/bolsa |
| KG-032N | 3.2 | 2.4-3.2 | Nylon | |
| KG-045N | 4.5 | 3.2-4.5 | Nylon | |

Cubre aristas recto



Material: PE. Color: Natural. Su presentación en rollo permite cortar la longitud deseada para la protección de aristas y filos.

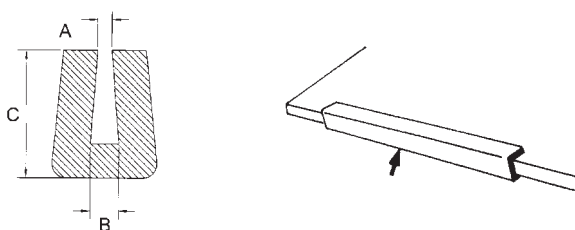

| Ref. | Dimensiones mm. | | | Grosor chasis | |
|---------------|-----------------|-----|------|---------------|-----|
| | A | B | C | | |
| ED-010 | 0.5 | 1.0 | 3.6 | 1.0 | 10m |
| ED-012 | 0.6 | 1.2 | 3.4 | 1.0-1.2 | 10m |
| ED-016 | 0.9 | 1.6 | 4.6 | 1.2-1.6 | 10m |
| ED-020 | 1.1 | 2.0 | 4.1 | 1.6-2.0 | 10m |
| ED-024 | 1.2 | 2.4 | 5.07 | 2.0-2.4 | 10m |
| ED-032 | 1.5 | 3.2 | 5.8 | 2.4-3.2 | 10m |

Pasacables a presión E98707 179603

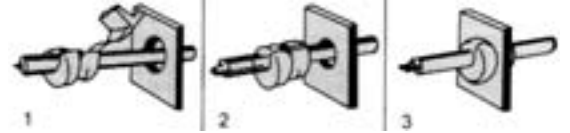
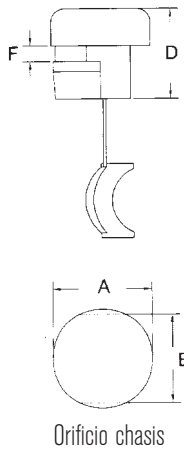

Material: Nylon 66 homologado  94V-2.

Color: ■ Negro.

Tiene múltiples aplicaciones y prolonga la vida de los cables de electrodomésticos, ordenadores, etc.

Forma del cable: I plano O redondo.

| Ref. | Forma del cable | Para usar con cables UL | Dimensiones mm. cable | Orificios chasis | | Largo D | Grosor chasis F |  |
|---------------|-----------------|---|-----------------------|------------------|------|---------|-----------------|---|
| | | | | A | B | | | |
| SR-F21 | plano | SPT-1 # 18 | 2,3 x 4,5/2,8 x 5,3 | 9,5 | 8,7 | 10,3 | 0,5-1,6 | 100/1000 |
| SR-F23 | plano | SPT-1 # 18 | 2,3 x 4,5/2,8 x 5,3 | 9,5 | 8,7 | 10,3 | 1,8-3,2 | 100/1000 |
| SR-F31 | plano | SPT-1 # 18 | 3,0 x 5,6 | 11,0 | 9,9 | 10,3 | 1,0-1,6 | 100/1000 |
| SR-F32 | plano | SPT-1 # 18 | 3,0 x 5,6 | 11,0 | 9,9 | 10,3 | 1,9-2,5 | 100/1000 |
| SR-F41 | plano | SPT-2 # 18 | 3,0 x 7,1/3,8 x 7,6 | 12,7 | 11,8 | 10,3 | 0,5-1,6 | 100/1000 |
| SR-F42 | plano | SPT-2 # 18 | 5 x 10,4 | 12,7 | 11,8 | 10,3 | 1,8-2,5 | 100/1000 |
| SR-F51 | plano | SPT-3 # 18 | 5 x 10,4 | 14,3 | 13,2 | 10,3 | 0,5-1,6 | 100/1000 |
| SR-F53 | plano | SPT-3 # 18 | 5 x 10,4 | 14,3 | 13,2 | 15,2 | 1,8-3,5 | 100/1000 |
| SR-F83 | plano | Cable para corriente alterna 3 C 2mm ² | 6 x 13 | 21,6 | 21,3 | 20,4 | 2,0-3,4 | 100/1000 |
| SR-5R1 | redondo | SVI, SVT 3C # 18 | 6,2Ø - 7,4Ø | 12,7 | 11,5 | 11,0 | 0,5-1,6 | 100/1000 |
| SR-5R2 | redondo | SVI, SVT 3C # 18 | 6,2Ø - 7,4Ø | 12,7 | 11,5 | 11,0 | 1,8-2,5 | 100/1000 |
| SR-6W2 | redondo | SJT 3C # 18 | 7,6Ø | 12,7 | 11,8 | 11,0 | 1,8-2,3 | 100/1000 |
| SR-6P1 | redondo | SJT 3C # 18 | 7,4Ø - 8,2Ø | 15,9 | 14,0 | 14,8 | 0,5-1,6 | 100/1000 |
| SR-6P3 | redondo | SJT 3C #18 | 7,4Ø - 8,2Ø | 15,9 | 14,0 | 14,8 | 1,9-3,2 | 100/1000 |
| SR-6R1 | redondo | SJ, SJT, 3C # 16 | 8,2Ø - 9,2Ø | 15,9 | 14,0 | 14,8 | 0,5-1,6 | 100/1000 |
| SR-6R3 | redondo | SJ, SJT, 3C # 16 | 8,2Ø -9,2Ø | 15,9 | 14,0 | 14,8 | 1,9-3,2 | 100/1000 |
| SR-7R1 | redondo | SJT, 3C # 14 | 9,2Ø-10,5Ø/11Ø | 19,0/19,8 | 16,5 | 19,0 | 0,5-1,6 | 100/1000 |
| SR-7R3 | redondo | SJT, 3C # 14 | 9,2Ø-10,5Ø/11Ø | 19,0/19,8 | 16,5 | 19,0 | 1,9-3,2 | 100/1000 |
| SR-8R3 | redondo | SJT, 3C # 12 | 12Ø-15,2Ø | 22,2 | 21,3 | 20,6 | 1,9-3,2 | 100/1000 |
| SR-9R1 | redondo | # 18 20-30 uds. | 11Ø-15Ø | 19 | 19 | 17,5 | 0,5-1,6 | 100/1000 |
| SR-9R7 | redondo | SJT, 3C # 10 | 15,2Ø-16,3Ø/17,5Ø | 28,0/30,2 | 25,5 | 25,2 | 1,0-3,2 | 100/1000 |

Herramienta para montaje de pasacables a presión



Ref.: **KT-1** (acero)

Para utilizar con pasacables:

SR-F21, SR-F23, SR-F31, SR-F32, SR-F41, SR-F42, SR-F51, SR-F53, SR-5R1, SR-5R2, SR-6W2, SR-6P1, SR-6P3, SR-6R1, SR-6R3, SR-7R1, SR-7R3, SR-8R3, SR-9R7.



Pasacables a presión 90° con protector de cable



Material: Nylon 66 homologado
 (UL) 94V-2. Color: ■ Negro.
 Para la protección de cables en electrodomésticos, ordenadores, etc. Cuando la salida del cable se halla en la parte inferior del aparato. Protección especial contra roturas. Montaje según dibujos.

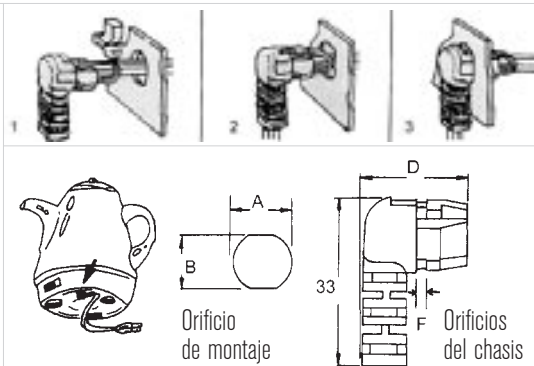

| Ref. | Forma del cable | Para usar con cables UL | Dimensiones mm. cable | Orificios chasis | | Largo D | Grosor chasis F | |
|-----------------|-----------------|-------------------------|-----------------------|---------------------|------|---------|-----------------|-----|
| | | | | A | B | | | |
| SR-F42LF | plano | SPT-2 | 3.3x6.6/3.6x7.2 | 12.7-13.2/13.2-13.7 | 10.9 | 20.5 | 1.5-2.0 | 100 |

Pasacables a presión con protector de cable



Material: Nylon 66 homologado
 (UL) 94V-2. Color: ■ Negro.

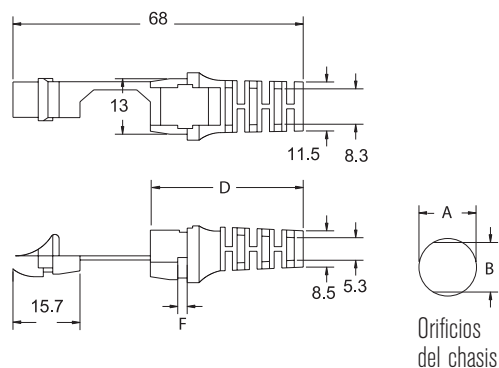

| Ref. | Forma del cable | Para usar con cables UL | Dimensiones mm. cable | Orificios chasis | | Largo D | Grosor chasis F | |
|----------------|-----------------|-------------------------|-----------------------|------------------|------|---------|-----------------|-----|
| | | | | A | B | | | |
| SR-F52F | plano | SPT-2 | 4.6x8 | 14.3 | 13.2 | 36 | 0.8-2.3 | 100 |

Pasacables a presión 90°



Material: Nylon 66 homologado
 (UL) 94V-2. Color: ■ Negro.
 Protege los cables del montaje en el chasis. Su diseño facilita la instalación en las partes inferiores de los aparatos. Montaje según dibujos.

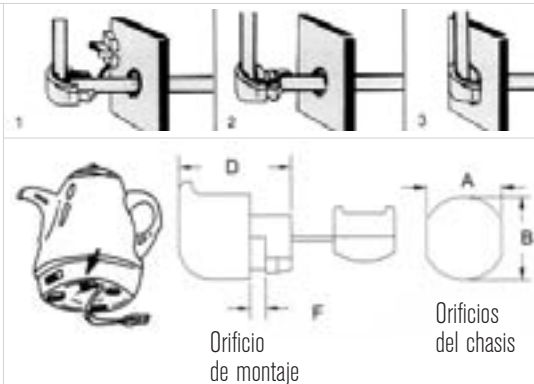

| Ref. | Forma del cable | Para usar con cables UL | Dimensiones mm. cable | Orificios chasis | | Largo D | Grosor chasis F | |
|----------------|-----------------|-------------------------|-----------------------|------------------|------|---------|-----------------|-----|
| | | | | A | B | | | |
| SR-F42L | plano | SPT-1/SPT-2 | 3x5.6/3.8x7.1 | 12.7 | 11.8 | 17.7 | 1.8-2.6 | 100 |



Pasacables

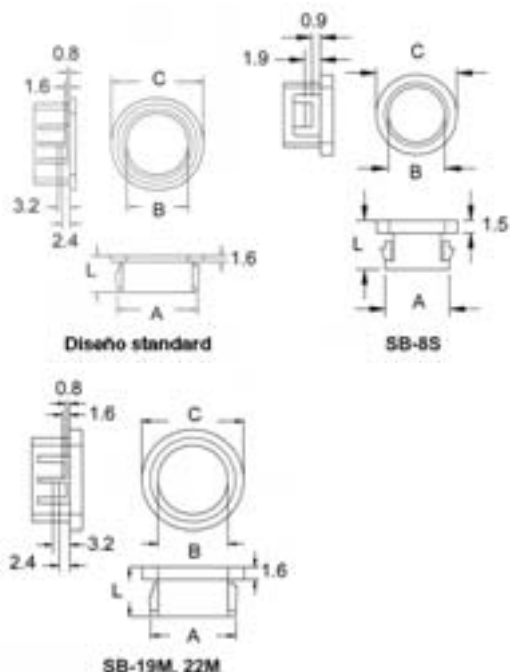

Material: Nylon 66 homologado (UL) 94V-2. Color: ■ Negro.
 Para la protección y el aislamiento de cables en chasis y aristas de orificios.
 De fácil instalación mediante una simple presión con los dedos.
 Para chasis de 0,8 a 3,2 mm. de espesor.

| Ref. | Orificio de montaje A | Dimensiones mm. | | | 📦 |
|---------------|-----------------------|-----------------|------|------|-----|
| | | B | C | L | |
| SB-8S | 7.8 | 6.8 | 9.8 | 6.0 | 100 |
| SB-12S | 11.9 | 9.2 | 13.7 | 6.3 | 100 |
| SB-8 | 7.8 | 5.2 | 9.4 | 8.0 | 100 |
| SB-10 | 9.5 | 6.3 | 12.0 | 10.3 | 100 |
| SB-13 | 12.7 | 8.2 | 14.5 | 10.3 | 100 |
| SB-16 | 15.9 | 12.2 | 18.6 | 10.3 | 100 |
| SB-19 | 19.0 | 14.3 | 21.5 | 10.3 | 100 |
| SB-19M | 19.0 | 15.8 | 21.7 | 10.3 | 100 |
| SB-22 | 22.0 | 17.3 | 23.8 | 11.5 | 100 |
| SB-22M | 22.2 | 18.9 | 24.2 | 11.5 | 100 |
| SB-26 | 25.1 | 19.1 | 28.0 | 11.5 | 100 |
| SB-30 | 29.7 | 24.1 | 32.2 | 11.5 | 100 |
| SB-38 | 38.1 | 29.0 | 41.2 | 11.4 | 100 |
| SB-45 | 43.6 | 35.4 | 47.8 | 11.6 | 100 |

Pasacables

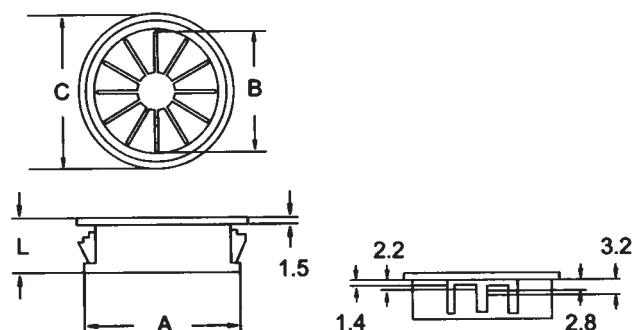

Material: Nylon 66 homologado (UL) 94V-2.
 Su diseño permite que una sola medida admita varias medidas de cable.
 Color: ■ Negro.

| Ref. | Orificio de montaje A | Dimensiones mm. | | | 📦 |
|---------------|-----------------------|-----------------|------|------|-----|
| | | B | C | L | |
| RSB-16 | 15.9 | 11.1 | 18.3 | 10.3 | 100 |
| RSB-19 | 19.0 | 12.7 | 21.8 | 9.9 | 100 |
| RSB-21 | 20.6 | 12.7 | 22.6 | 9.9 | 100 |
| RSB-22 | 22.2 | 14.3 | 23.8 | 11.5 | 100 |
| RSB-25 | 25.3 | 20.4 | 28.5 | 11.3 | 100 |
| RSB-28 | 27.6 | 22.4 | 30.8 | 11.3 | 100 |
| RSB-35 | 34.2 | 29.3 | 37.5 | 11.3 | 100 |



Pasacables abierto/cerrado

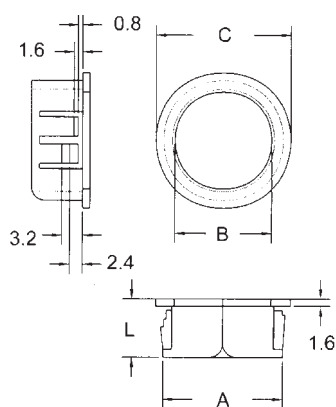

Material: Nylon 66 homologado (UL) 94V-2. Color: ■ Negro. Para protección y aislamiento de cables en chasis y aristas de orificios. Gracias a su especial diseño, se pueden montar cuando los cables ya están instalados. No se precisa herramienta para su montaje. Para chasis de espesor de 0,8 a 3,2 mm.

| Ref. | Orificio de montaje A | Dimensiones mm. | | L | |
|---------------|-----------------------|-----------------|------|------|-----|
| | | B | C | | |
| OSB-10 | 9.5 | 6.7 | 10.7 | 10.3 | 100 |
| OSB-13 | 12.7 | 8.0 | 14.2 | 10.3 | 100 |
| OSB-16 | 15.9 | 11.5 | 17.7 | 10.3 | 100 |
| OSB-19 | 19.0 | 13.1 | 20.2 | 10.3 | 100 |
| OSB-22 | 22.2 | 17.0 | 23.4 | 10.3 | 100 |
| OSB-26 | 25.5 | 20.2 | 27.0 | 10.3 | 100 |

Tapa orificios

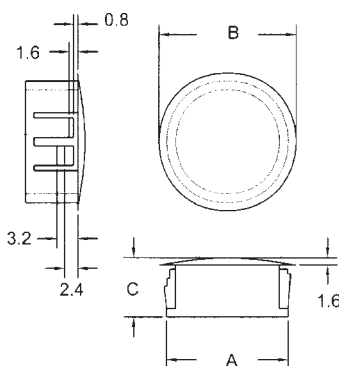

Material: Nylon 66 homologado (UL) 94V-2. Color: ■ Negro. Aplicación con una simple presión de los dedos. Tapa los orificios innecesarios y mejora la apariencia de los chasis. Para chasis de 0,8 a 3,2 mm.

| Ref. | Orificio de montaje A | Dimensiones mm. | | |
|--------------|-----------------------|-----------------|------|----------|
| | | B | C | |
| HP-8 | 7.8 | 11.9 | 8.0 | 100/1000 |
| HP-10 | 9.5 | 13.0 | 10.5 | 100/1000 |
| HP-13 | 12.7 | 16.9 | 10.5 | 100/1000 |
| HP-16 | 15.9 | 19.8 | 10.5 | 100/1000 |
| HP-19 | 19.0 | 22.9 | 10.5 | 100/1000 |
| HP-22 | 22.2 | 24.9 | 11.3 | 100/1000 |
| HP-25 | 25.0 | 28.3 | 11.5 | 100/1000 |
| HP-30 | 30.0 | 34.2 | 11.5 | 100/1000 |
| HP-38 | 38.1 | 42.4 | 11.2 | 100/1000 |
| HP-45 | 44.5 | 49.1 | 11.1 | 100/1000 |

Tapa orificios roscado



ROSCA MÉTRICA.

Material: Nylon 66 homologado (UL) 94V-2. Color: ■ Gris.



| Ref. | Dimensiones mm. | | | | |
|---------------|-----------------|------|------|------|-----|
| | A | B | C | D | |
| MSP-12 | M12 x 1.5 | 15.0 | 10.0 | 6.0 | 100 |
| MSP-16 | M16 x 1.5 | 20.0 | 10.5 | 6.0 | 100 |
| MSP-20 | M20 x 1.5 | 24.0 | 10.5 | 6.0 | 100 |
| MSP-25 | M25 x 1.5 | 29.7 | 12.8 | 7.8 | 100 |
| MSP-32 | M32 x 1.5 | 36.6 | 13.3 | 7.8 | 50 |
| MSP-40 | M40 x 1.5 | 45.8 | 13.4 | 7.8 | 50 |
| MSP-50 | M50 x 1.5 | 55.5 | 16.2 | 9.8 | 10 |
| MSP-63 | M63 x 1.5 | 69.3 | 17.5 | 11.8 | 10 |



Tapa orificios roscado

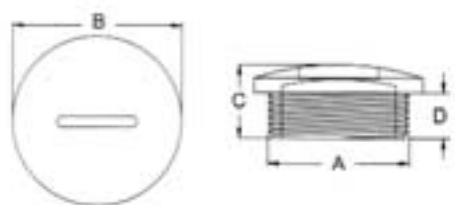

ROSCA PG. Material: Nylon 66 homologado UL 94V-2. Color: ■ Gris.

| Ref. | Dimensiones mm. | | | | |
|-----------------|-----------------|------|------|------|-----|
| | A | B | C | D | |
| PSP-7 | PG-7 | 14.8 | 10.0 | 6.0 | 100 |
| PSP-9 | PG-9 | 18.7 | 10.4 | 6.0 | 100 |
| PSP-11 | PG-11 | 21.7 | 10.4 | 6.0 | 100 |
| PSP-13.5 | PG-13.5 | 23.7 | 10.3 | 6.0 | 100 |
| PSP-16 | PG-16 | 27.0 | 10.3 | 6.0 | 100 |
| PSP-21 | PG-21 | 32.8 | 12.8 | 7.8 | 100 |
| PSP-29 | PG-29 | 44.1 | 13.3 | 7.8 | 50 |
| PSP-36 | PG-36 | 52.6 | 13.7 | 7.7 | 50 |
| PSP-42 | PG-42 | 59.5 | 16.3 | 9.6 | 10 |
| PSP-48 | PG-48 | 64.2 | 18.0 | 11.8 | 10 |

Pasacables (ABIERTO/CERRADO)



Material: PVC. Color: ■ Negro.

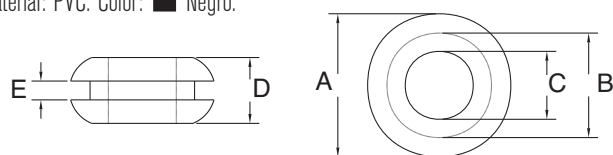

Tipo GM

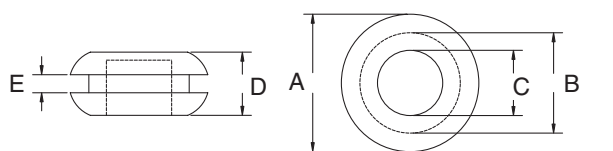

Tipo GMC

| Ref. ABIERTO | Ref. CERRADO | Dimensiones mm. | | | | | |
|----------------|-----------------|-----------------|------|------|-----|-----|-----|
| | | A | B | C | D | E | |
| GM-0603 | GMC-0603 | 8.5 | 6.0 | 3.0 | 4.7 | 1.7 | 100 |
| GM-0705 | GMC-0705 | 10.2 | 7.2 | 5.0 | 4.4 | 1.7 | 100 |
| GM-1006 | GMC-1006 | 13.3 | 10.0 | 6.4 | 6.3 | 1.7 | 100 |
| GM-1410 | GMC-1410 | 19.5 | 13.9 | 10.5 | 6.4 | 3.4 | 100 |
| GM-2015 | GMC-2015 | 23.7 | 20.1 | 15.5 | 6.1 | 1.7 | 100 |
| GM-2518 | GMC-2518 | 29.9 | 25.1 | 18.9 | 7.2 | 1.5 | 100 |
| GM-3225 | GMC-3225 | 38.1 | 31.7 | 25.0 | 7.8 | 1.5 | 100 |

Pasacables (ABIERTO/CERRADO)



Material: PVC. Color: ■ Negro.

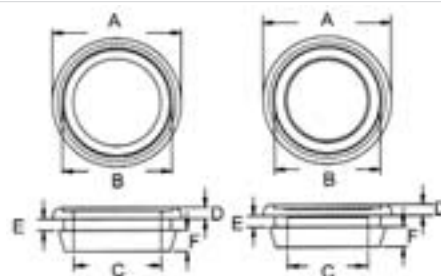

Tipo GE

Tipo GEC

| Ref. ABIERTO | Ref. CERRADO | Dimensiones mm. | | | | | | |
|-----------------|------------------|-----------------|------|------|-----|-----|-----|-----|
| | | A | B | C | D | E | F | |
| GE-2015 | GEC-2015 | 23.9 | 19.6 | 15.5 | 2.1 | 2.0 | 3.9 | 100 |
| GEQ-2015 | GECQ-2015 | 23.9 | 19.6 | 15.5 | 2.1 | 2.0 | 3.9 | 100 |
| GEQ-2621 | GECQ-2621 | 30.0 | 26.0 | 20.8 | 2.4 | 2.4 | 3.8 | 100 |



Pasacables cuadrado



Material: Nylon 66 homologado (UL) 94V-2.

Colores: Natural.

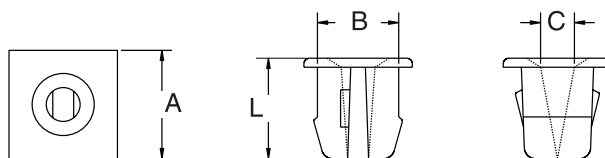

| Ref. | Orificio de montaje A | Dimensiones mm. | | | L | |
|---------------|-----------------------|-----------------|-----|-----|-----|--|
| | | B | C | | | |
| SGN-07 | 9.6 | 7.2 | 3.0 | 8.9 | 100 | |

Tapa protectora para conector

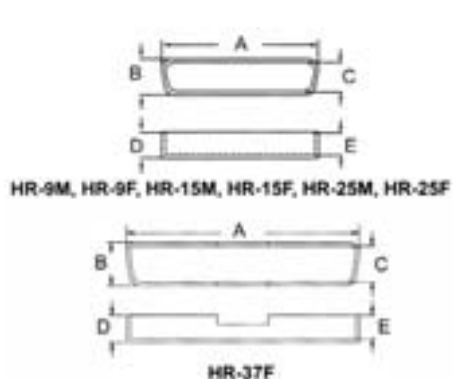

Material: PE. Protege los contactos de los conectores contra la suciedad cuando no se utilizan. Colores: Natural.

| Ref. | Dimensiones mm. | | | | | Para PIN macho-hembra |
|---------------|-----------------|------|------|-----|-----|-----------------------|
| | A | B | C | D | E | |
| HR-9M | 20.0 | 11.0 | 9.2 | 7.2 | 6.1 | 9PIN MACHO 100 |
| HR-9F | 18.1 | 9.2 | 7.85 | 6.5 | 5.7 | 9PIN HEMBRA 100 |
| HR-15M | 28.2 | 10.9 | 9.1 | 7.0 | 6.0 | 15PIN MACHO 100 |
| HR-15F | 26.5 | 9.5 | 7.5 | 6.9 | 5.9 | 15PIN HEMBRA 100 |
| HR-25M | 42.0 | 10.9 | 9.1 | 7.3 | 6.3 | 25PIN MACHO 100 |
| HR-25F | 40.6 | 9.5 | 7.8 | 6.8 | 5.9 | 25PIN HEMBRA 100 |
| HR-37F | 57.5 | 10.9 | 8.3 | 7.5 | 6.5 | 37PIN HEMBRA 100 |

Tapa protectora para conector

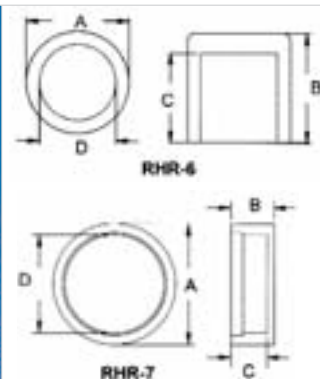

Material: Nylon 66 homologado (UL) 94V-2. Protege los contactos de los conectores contra la suciedad cuando no se utilizan. Colores: Natural.

| Ref. | Dimensiones mm. | | | | |
|--------------|-----------------|-----|-----|-----|-----|
| | A | B | C | D | |
| RHR-6 | 8.2 | 8.8 | 7.3 | 6.1 | 100 |
| RHR-7 | 8.0 | 3.0 | 2.5 | 6.6 | 100 |

Tapa protectora para conector

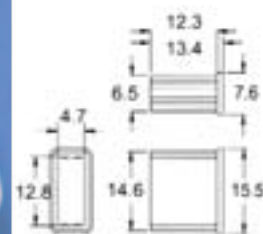

Material: PE. Protege los contactos de los conectores contra la suciedad cuando no se utilizan. Colores: Natural.

| Ref. | Dimensiones mm. | |
|--------------|-----------------|-----|
| USB-1 | Según figura | 100 |



GRAPAS
Y TACOS



Grapas para cables tipo telefónico



Material: PE resistente al impacto. Color: ■ Gris.
Para fijación de cables telefónicos con clavo.

| Ref. | Dimensiones mm. | | | Clavo | |
|-------------|-----------------|---|-----|--------|-----|
| | W | H | H1 | | |
| NT-1 | 4.8 | 7 | 2.5 | 2 x 15 | 100 |

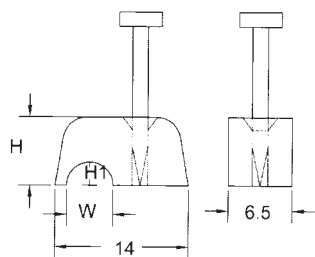

Grapas para cables tipo telefónico



Material: PE resistente al impacto.
Color: □ Blanco. Otros colores bajo demanda.
Para fijación de cables telefónicos con clavo.

| Ref. | Dimensiones mm. | | |
|----------------|-----------------|--------|-----|
| | W | Clavo | |
| NT-0204 | 4.1 | 2 x 20 | 100 |
| NT-0407 | 7.0 | 2 x 20 | 100 |
| NT-0711 | 9.0 | 2 x 35 | 100 |
| NT-1114 | 13.2 | 2 x 35 | 100 |

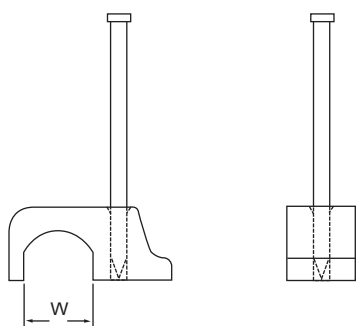



Grapas para cables planos con clavo



Material: PE resistente al impacto. Color: Blanco.

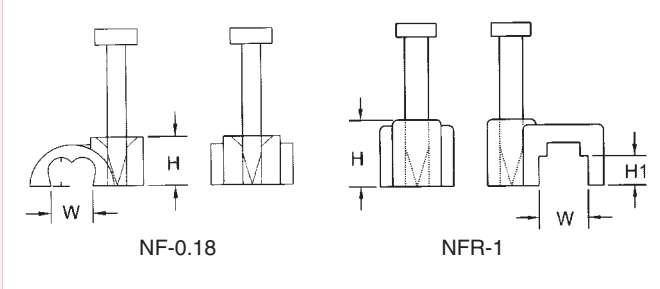

| Ref. | Dimensiones mm. | | | Para Cables | Clavo | |
|----------------|-----------------|-----|-----|-------------------------|--------|-----|
| | W | H | H1 | | | |
| NF-0.18 | 4.5 | 4.3 | 2.7 | 0.8 m/m ² 2C | 2.0x15 | 100 |
| NFR-1 | 5.1 | 6.8 | 3 | 0.8 m/m ² 2C | 2.5x18 | 100 |
| NFR-1S | 5.1 | 6.8 | 3 | 0.8 m/m ² 2C | 2.0x20 | 100 |

Grapas para cable telefónico con clavo

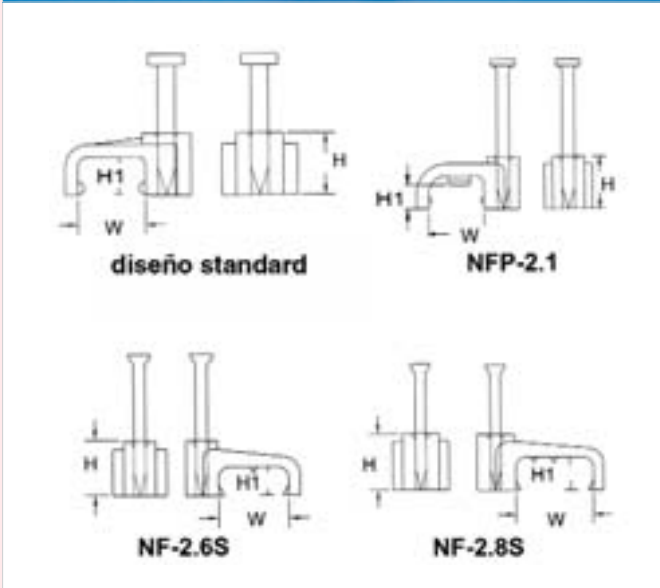

| Ref. | Dimensiones mm. | | | Clavo | Para Cables | |
|----------------|-----------------|------|------|---------|----------------------------------|-----|
| | W | H | H1 | | | |
| NF-0.25 | 2.1 | 4.5 | 1.5 | 1.65x15 | | 100 |
| NF-0.7 | 5.5 | 5.5 | 3.1 | 2x15 | | 100 |
| NF-1.2 | 6.2 | 5.4 | 3.8 | 2x15 | | 100 |
| NF-1.4 | 6.4 | 5.7 | 4.1 | 2x25 | | 100 |
| NF-1.6 | 8.0 | 8 | 5.0 | 2x15 | | 100 |
| NF-2.0S | 8.5 | 8 | 5.2 | 2x25 | | 100 |
| NF-2.2S | 10.0 | 10.0 | 6.5 | 2x25 | | 100 |
| NF-2.3 | 10.2 | 6.3 | 4.6 | 2x25 | | 100 |
| NF-2.6S | 13.5 | 11.6 | 8.1 | 2x25 | | 100 |
| NF-2.8S | 15 | 12.8 | 8.7 | 2x25 | Núcleo de conexión | 100 |
| NFT-1.5 | 9.8 | 6.7 | 4.4 | 2x25 | a tierra 3 mm ² . | 100 |
| NFT-4.0 | 11.6 | 9.7 | 6.4 | 2x25 | Cable 4.00 mm ² . T&E | 100 |
| NFD-1.0 | 16.8 | 7.2 | 4.4 | 2x25 | Cable 1.0/1.5 mm ² . | 100 |
| NFP-2.1 | 9.3 | 8.7 | 4 | 2x25 | Doble T&E | 100 |
| NF-2.0 | 8.5 | 8 | 5.2 | 2.5x18 | | 100 |
| NF-2.2 | 10.0 | 10.0 | 6.5 | 2.5x18 | | 100 |
| NF-2.6 | 13.5 | 11.6 | 8.1 | 2.5x22 | | 100 |
| NF-2.8 | 15 | 12.8 | 8.7 | 2.5x22 | | 100 |
| NF-3.0 | 18 | 12.9 | 9.5 | 2.5x27 | | 100 |
| NF-3.2 | 19 | 14.2 | 11.1 | 2.5x27 | Cable 16.0 mm ² . T&E | 100 |
| NFT-16 | 20.2 | 13.2 | 10.1 | 2.5x35 | Cable 2.5 mm ² . | 100 |
| NFD-2.5 | 19.3 | 8.7 | 5.5 | 2.5x30 | Doble T&E | 100 |
| NF-5.0 | 49 | 33 | 26 | 4.0x50 | | 50 |

Material: PE resistente al impacto. Color: Blanco.
Para fijación de cables telefónicos, con clavo.



Grapas de sujeción

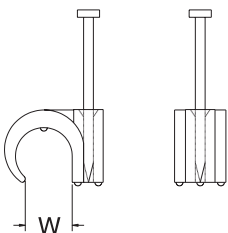

Material: PE resistente a grandes impactos.

Color: Blanco. Otros colores bajo demanda.

| Ref. | Dimensiones mm. | | |
|------------------|-----------------|----------|-----|
| | W | Clavo | |
| NC-0507 | 5-7 | 2.0 x 20 | 100 |
| *NC-0507L | 5-7 | 2.0 x 20 | 100 |
| NC-0810 | 8-10 | 2.0 x 25 | 100 |
| NC-1115 | 11-15 | 2.0 x 35 | 100 |
| NC-1619 | 16-19 | 2.5 x 40 | 100 |

*** NC-0507L: gancho más largo**

Grapas para cables redondos en general, con clavo

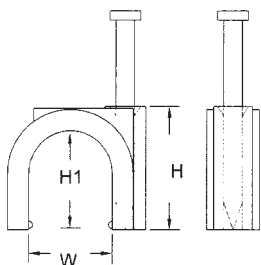

| Ref. | Dimensiones mm. | | | Clavo | |
|------------------|-----------------|------|------|-----------|-----|
| | W | H | H1 | | |
| NC-0.275N | 2.75 | 4.5 | 2.6 | 1.65 x 19 | 100 |
| NC-0.35N | 3.5 | 5.9 | 3.7 | 2.0 x 15 | 100 |
| NC-0.4N | 4 | 6.6 | 4.2 | 2.5 x 18 | 100 |
| NC-0.5N | 5 | 7.6 | 5.3 | 2.5 x 18 | 100 |
| NC-0.5NS | 5 | 7.6 | 5.3 | 2.0 x 20 | 100 |
| NC-1NS | 6 | 9 | 6.6 | 2.0 x 20 | 100 |
| NC-2NS | 8 | 11.5 | 8.6 | 2.0 x 25 | 100 |
| NC-2.5NS | 9 | 12 | 9 | 2.0 x 22 | 100 |
| NC-1N | 6 | 9 | 6.6 | 2.5 x 18 | 100 |
| NC-1NL | 6 | 10.5 | 6.9 | 2.5 x 20 | 100 |
| NC-1.5N | 7 | 11 | 7.2 | 2.5 x 22 | 100 |
| NC-2N | 8 | 11.5 | 8.6 | 2.5 x 22 | 100 |
| NC-2.5N | 9 | 12 | 9 | 2.5 x 22 | 100 |
| NC-3N | 10 | 13.4 | 10.5 | 2.5 x 25 | 100 |
| NC-3NS | 10 | 13.4 | 10.5 | 2.0 x 25 | 100 |
| NC-3.5N | 11 | 16.6 | 12.2 | 2.5 x 27 | 100 |
| NC-4N | 12 | 16.0 | 12.5 | 2.5 x 27 | 100 |
| NC-6N | 14 | 20.5 | 15.6 | 3.0 x 35 | 100 |
| NC-7N | 16 | 21.7 | 17.0 | 3.2 x 38 | 100 |
| NC-7.2N | 18 | 22.0 | 17.5 | 3.2 x 38 | 100 |
| NC-7.5N | 20 | 23.5 | 18.5 | 3.2 x 38 | 100 |
| NC-8N | 22 | 27.8 | 22.5 | 3.2 x 42 | 100 |
| NC-9N | 25 | 31.6 | 26.0 | 3.2 x 47 | 100 |
| NC-10N | 32 | 40 | 33.5 | 3.6 x 56 | 50 |

Material: PE resistente a grandes impactos.

Color standard: Gris.

Para blanco añadir BL. Para negro añadir NG.

Para todo tipo de cables redondos.



Grapas de sujeción con dos clavos



Material: PE resistente a grandes impactos. Color: Blanco.
Otros colores disponibles bajo demanda. Diseñado con dos clavos para que sujete más firmemente el cable.

| Ref. | Dimensiones mm. | | | Para Cables | Clavo | |
|---------------|-----------------|---|-----|-----------------|---------|-----|
| | W | H | H1 | | | |
| DNF-13 | 12.5 | 8 | 5.3 | #14/2,14/3,12/2 | 1.86x31 | 100 |
| DNF-19 | 18.7 | 8 | 5.3 | #12/3,10/2,10/3 | 1.86x31 | 100 |

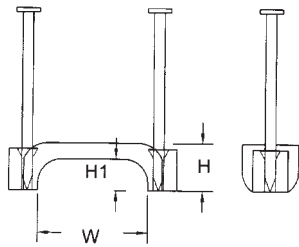

Grapas de sujeción con dos clavos



Material: PE resistente a grandes impactos.
Color: Gris. Otros colores bajo demanda.
Diseñado con dos clavos para que sujete más firmemente los cables.

| Ref. | Dimensiones mm. | | | Para Cables | Clavo | |
|---------------|-----------------|----|------|-------------|----------|----|
| | W | H | H1 | | | |
| DNC-10 | 32 | 40 | 33.5 | 1" | 3.6 x 56 | 20 |
| DNC-12 | 40 | 50 | 41 | 1 1/4" | 4.0 x 68 | 20 |
| DNC-15 | 49 | 59 | 50 | 1 1/2" | 4.0 x 78 | 20 |
| DNC-20 | 62 | 71 | 62 | 2" | 4.5 x 97 | 20 |

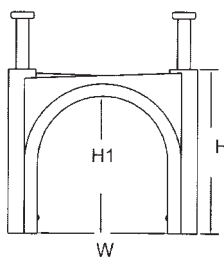



Taco a presión



Material: PE resistente a grandes impactos. Color: Natural.

| Ref. | Dimensiones mm. | | |
|----------------|-----------------|----|-----|
| | W | L | |
| PP-0518 | 5 | 18 | 100 |

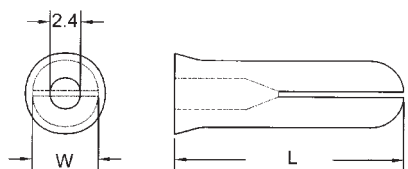



**ACCESORIOS PARA
CIRCUITOS
IMPRESOS**



Soporte para circuito impreso

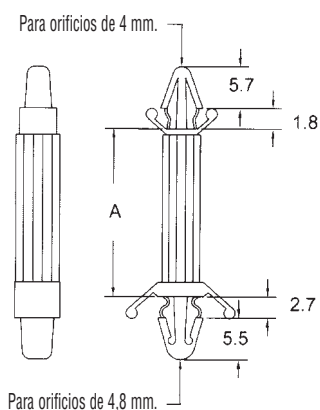

Material: Nylon 66 homologado (UL) 94V-2. Color: Blanco.
Fijación por presión. Se puede quitar o sustituir fácilmente.

| Ref. | Dimensiones mm. A | |
|------------------|---------------------------------------|------|
| CS-0305 | 4.8 (3/16") | 1000 |
| CS-0305S | 4.8 (3/16") para taladro de 3 mm. | 1000 |
| CS-0406 | 6.4 (1/4") | 1000 |
| CS-0610 | 9.6 (3/8") | 1000 |
| CS-0813 | 12.7 (1/2") | 1000 |
| CS-1016 | 15.9 (5/8") | 1000 |
| CS-1219 | 19.1 (3/4") | 1000 |
| CS-1422 | 22.2 (7/8") | 1000 |
| CS-1625 | 25.4 (1") | 1000 |
| CS-1828 | 28.5 (1 1/8") | 1000 |
| CS-2236 | 35.0 (1 3/8") | 1000 |
| CS-2236L* | 35.0 (1 3/8") para taladro de 4.8 mm. | 1000 |

Soporte para circuito impreso

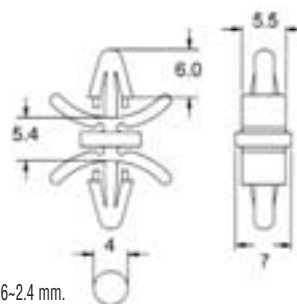

Para orificios de 1.6-2.4 mm.

Material: Nylon 66 homologado (UL) 94V-2. Color: Blanco.

| Ref. | Dimensiones mm. A | |
|-----------------|-------------------|------|
| CS-0305L | 5.4 | 1000 |

Soporte para circuito impreso



Para orificios de 2 mm.

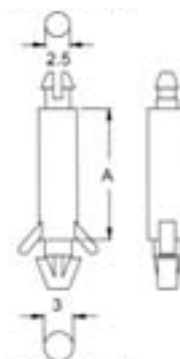

Para orificios de 1-1.7 mm.

Material: Nylon 66 homologado (UL) 94V-2. Color: Blanco.

| Ref. | Dimensiones mm. A | |
|---------------|-------------------|-----|
| LCA-14 | 13.6 | 100 |

Mini soporte para circuito impreso

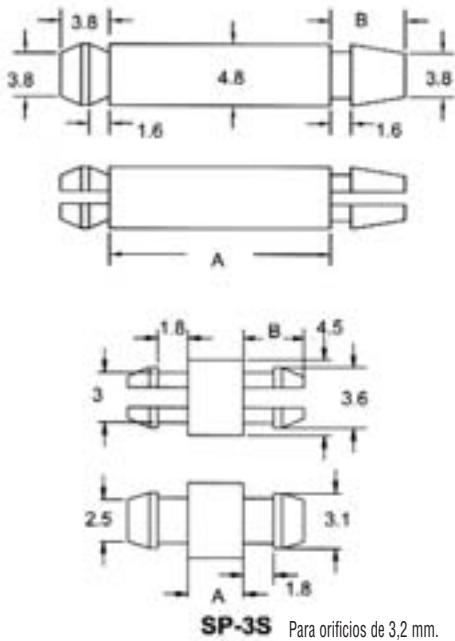

Material: Nylon 66 homologado UL 94V-2. Color: Blanco.
 Taladro de fijación 4 mm. Para usos en los que el espacio es limitado y la altura de las fijaciones debe ser mínima.

| Ref. | Dimensiones mm. | | |
|--------------|-----------------|-----|------|
| | A | B | |
| SP-3 | 3.2 | 3.8 | 1000 |
| SP-3S | 3.2 | 3.6 | 1000 |
| SP-6 | 6.3 | 3.8 | 1000 |
| SP-8 | 8.0 | 3.8 | 1000 |
| SP-10 | 10.5 | 3.8 | 1000 |
| SP-13 | 12.7 | 5.6 | 1000 |
| SP-16 | 15.9 | 5.6 | 1000 |
| SP-17 | 16.5 | 5.6 | 1000 |
| SP-19 | 19.1 | 5.6 | 1000 |
| SP-22 | 22.2 | 5.6 | 1000 |
| SP-25 | 25.4 | 5.6 | 1000 |

Soporte para circuito impreso -fijación a chasis-

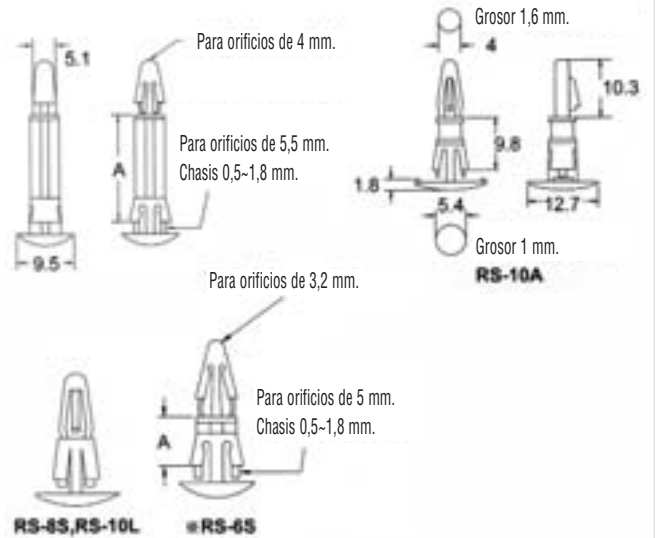

Material: Nylon 66 homologado UL 94V-2. Color: Blanco.

| Ref. | A mm. | |
|---------------|-------|----------|
| RS-3 | 3.5 | 100/1000 |
| RS-5 | 5.0 | 100/1000 |
| RS-6 | 6.4 | 100/1000 |
| RS-6S* | 6.4 | 100/1000 |
| RS-8 | 8.0 | 100/1000 |
| RS-8S | 8.0 | 100/1000 |
| RS-10 | 9.6 | 100/1000 |
| RS-10S | 9.3 | 100/1000 |
| RS-10A | 9.8 | 100/1000 |
| RS-10L | 10.8 | 100/1000 |
| RS-12 | 12.0 | 100/1000 |
| RS-14 | 14.0 | 100/1000 |
| RS-18 | 18.0 | 100/1000 |



Soporte para circuito impreso -fijación por tornillo-

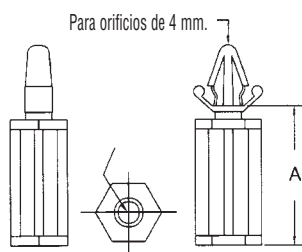

Material: Nylon 66 homologado (UL) 94V-2. Color: Blanco.
Fijación al chasis mediante tornillo de #6 (1/8").

| Ref. | A mm. | |
|--------------|---------------|----------|
| CS-5 | 5.0 (3/16") | 100/1000 |
| CS-10 | 9.6 (3/8") | 100/1000 |
| CS-13 | 12.7 (1/2") | 100/1000 |
| CS-19 | 19.1 (3/4") | 100/1000 |
| CS-28 | 28.5 (1 1/8") | 100/1000 |
| CS-35 | 35.0 (1 3/8") | 100/1000 |

Soporte para circuito impreso -fijación a chasis-

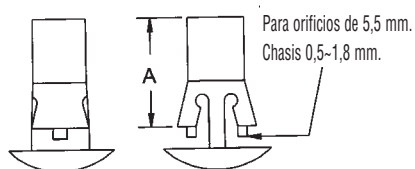
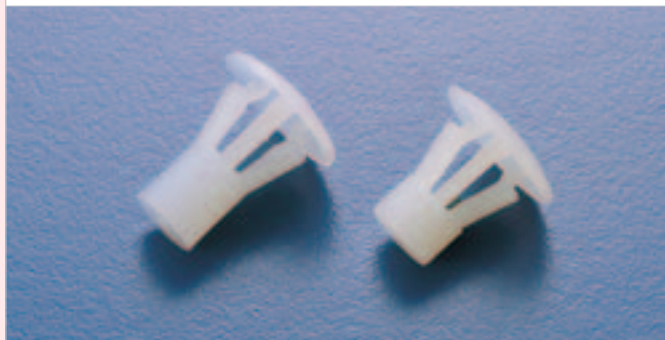

Material: Nylon 66 homologado (UL) 94V-2. Color: Blanco.
Fijación por presión.

| Dimensiones mm. | | | Dimensiones mm. | | |
|-----------------|-----|----------|-----------------|------|----------|
| Ref. | A | | Ref. | A | |
| RLS-5 | 5.0 | 100/1000 | RLS-10 | 10.1 | 100/1000 |
| RLS-6 | 6.4 | 100/1000 | RLS-12 | 12.0 | 100/1000 |
| RLS-8 | 8.0 | 100/1000 | RLS-14 | 14.0 | 100/1000 |
| RLS-9 | 9.8 | 100/1000 | RLS-18 | 18.0 | 100/1000 |

Extractor de circuito impreso



Ref.: **BE-1**

: 100/1000

Material: Nylon 66 homologado (UL) 94V-2.
Color: Blanco.
Pre-taladro para fijación en paneles de control 2,5-2,6 mm.

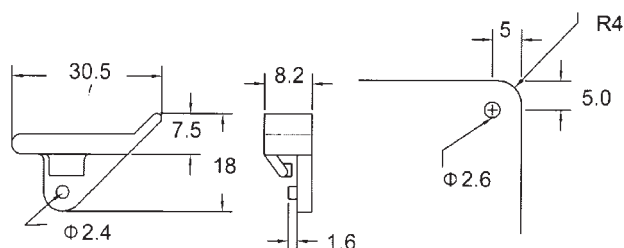

Soporte distanciador para circuito impreso



Ref.: **SCS-10**

: 100/1000

Material:
Nylon 66 94V-2.
Color: Blanco.

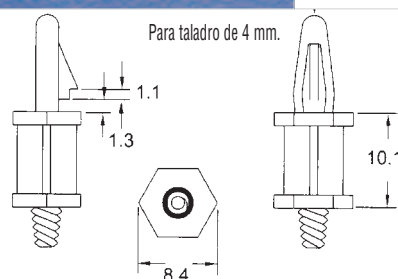



Soporte para circuito impreso a presión

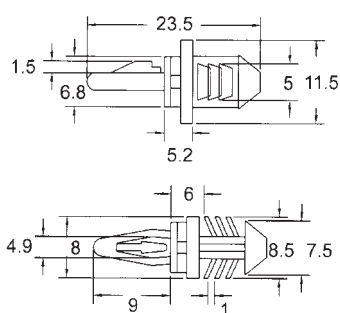

Material: Nylon 66 homologado (UL) 94V-2. Color: Blanco.

| Ref. | Dimensiones mm. | |
|--------------|-----------------|----------|
| BCS-5 | Ver figura | 100/1000 |

Soporte para circuito impreso

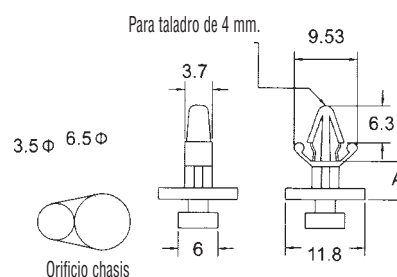

Material: Nylon 66 homologado (UL) 94V-2. Color: Blanco.
Fijación al chasis por desplazamiento del soporte del orificio de mayor a menor según dibujos.

| Ref. | Dimensiones mm. A | |
|-------------|-------------------|----------|
| MS-6 | 6.4 | 100/1000 |

Distanciador para circuito impreso



Material: Nylon 66 homologado (UL) 94V-2.
Color: Blanco.
Fijación al chasis por presión.
Taladro de instalación 4,8 mm.

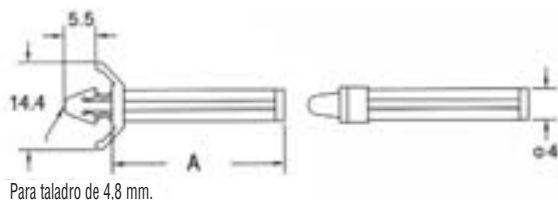

Para taladro de 4,8 mm.

| Ref. | Dimensiones mm. | | | Ref. | Dimensiones mm. | | |
|--------------|-----------------|----------|--|--------------|-----------------|----------|--|
| | A | | | | A | | |
| PS-5 | 4.8 (3/16") | 100/1000 | | PS-19 | 19.1 (3/4") | 100/1000 | |
| PS-6 | 6.4 (1/4") | 100/1000 | | PS-22 | 22.2 (7/8") | 100/1000 | |
| PS-10 | 9.6 (3/8") | 100/1000 | | PS-25 | 25.4 (1") | 100/1000 | |
| PS-13 | 12.7 (1/2") | 100/1000 | | PS-28 | 28.5 (1 1/8") | 100/1000 | |
| PS-16 | 15.9 (5/8") | 100/1000 | | PS-36 | 35.0 (1 3/8") | 100/1000 | |

Soporte para circuito impreso

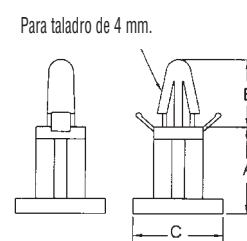

Material: Nylon 66 homologado (UL) 94V-2. Color: Blanco.
BMS-5L y BMS-5L7: para orificio de 4,8 mm.

| Ref. | Dimensiones mm. | | | |
|----------------|-----------------|-----|------|----------|
| | A | B | C | |
| BMS-5 | 5.6 | 9.5 | 11.8 | 100/1000 |
| BMS-5L7 | 5.6 | 9.5 | 7.1 | 100/1000 |
| BMS-5L | 5.6 | 9.5 | 11.8 | 100/1000 |
| BMS-8 | 8.0 | 9.5 | 11.8 | 100/1000 |
| BMS-11 | 11.0 | 9.0 | 12.0 | 100/1000 |



Distanciador para circuito impreso de fijación lateral

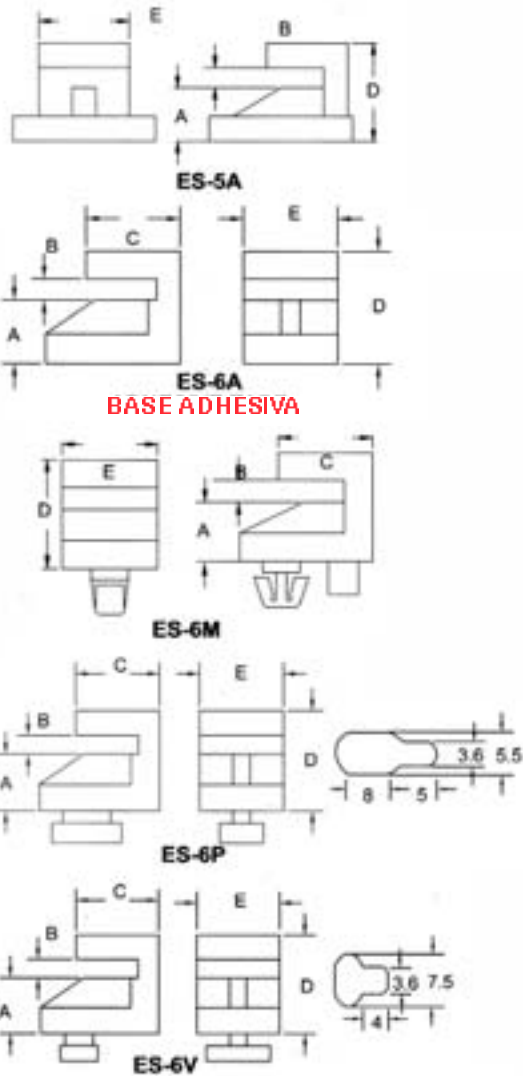
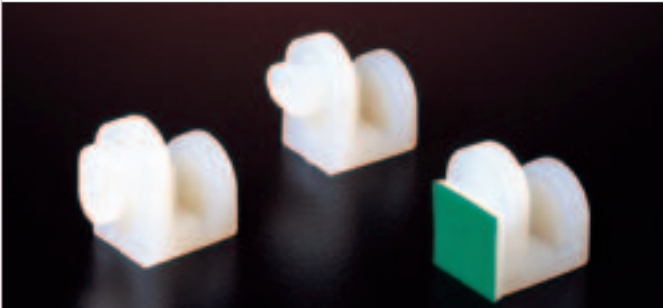

Material: Nylon 66 homologado (UL) 94V-2. Color: Blanco.
 Instalación en los taladros del chasis según dibujos.

| Ref. | Dimensiones mm. | | | | | |
|--------------|-----------------|-----|-----|------|-----|----------|
| | A | B | C | D | E | |
| ES-5A | 5.4 | 2.2 | 5.5 | 10.3 | 9.5 | 100/1000 |
| ES-6A | 6.0 | 1.9 | 9.0 | 10.8 | 8.7 | 100/1000 |
| ES-6M | 5.8 | 2.2 | 9.3 | 10.7 | 9.5 | 100/1000 |
| ES-6P | 6.0 | 1.9 | 9.0 | 10.8 | 8.7 | 100/1000 |
| ES-6V | 6.0 | 1.9 | 9.0 | 10.8 | 8.7 | 100/1000 |

Distanciador hexagonal para circuito impreso



Material: Nylon 66 homologado (UL) 94V-2. Color: Blanco.

| Ref. | Dimensiones mm. | | | | |
|----------------|-----------------|-----|----|-----|----------|
| | L | A | B | C | |
| HTN-380 | 79 | 5.5 | 15 | 2.7 | 100/1000 |

Soporte para circuito impreso



Material: Nylon 66 homologado (UL) 94V-2. Color: Blanco.

| Ref. | Dimensiones mm. A | |
|---------------|-------------------|----------|
| TMS-17 | 17.2 | 100/1000 |

Soporte para circuito impreso

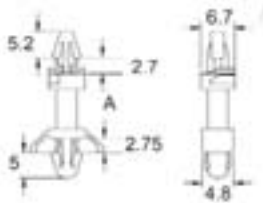

Material:
Nylon 66 homologado
Ⓢ 94V-2.
Color: Blanco.

| Ref. | Dimensiones mm. A | |
|-----------------|-------------------|----------|
| KCS-0813 | 12.5 | 100/1000 |

Soporte para circuito impreso

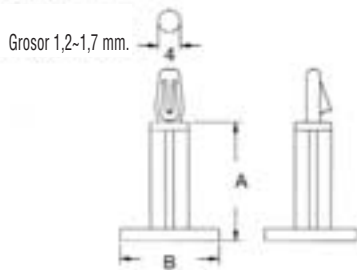

Material: Nylon 66 homologado Ⓢ 94V-2. Color: Blanco.

| Ref. | Dimensiones mm. | | |
|---------------|-----------------|------|----------|
| | A | B | |
| MMS-21 | 21.3 | 17.9 | 100/1000 |

Guía soporte para circuito impreso

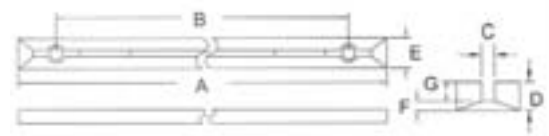

BT-90, 120, 140, 160



BT-90A, BT-155A



BT-160A

Material: Nylon 66 homologado Ⓢ 94V-2. Color: Blanco.
Fijación de la guía mediante dos tornillos de cabeza plana de 3 mm.
La fijación de la BT-90A y T-160A es por presión.

| Ref. | Dimensiones mm. | | | | | | | |
|----------------|-----------------|-------|-----|-----|-----|-----|-----|----------|
| | A | B | C | D | E | F | G | |
| BT-90A | 89 | 77 | 1.9 | 4.5 | 9.5 | 1.5 | 3 | 100/1000 |
| BT-90 | 89 | 64.5 | 1.9 | 4.5 | 9.5 | 1.5 | 3 | 100/1000 |
| BT-120 | 119 | 94.5 | 1.9 | 4.5 | 9.5 | 1.5 | 3 | 100/1000 |
| BT-140 | 140 | 115.0 | 1.9 | 4.5 | 9.5 | 1.5 | 3 | 100/1000 |
| BT-155A | 153.5 | 140.5 | 2.0 | 4.6 | 6.5 | 1.3 | 3.3 | 100/1000 |
| BT-160 | 160 | 134.5 | 1.9 | 4.5 | 9.5 | 1.5 | 3 | 100/1000 |
| BT-160A | 163 | 149.5 | 1.9 | 6.5 | 9.5 | 2.2 | 2.3 | 100/1000 |





Soporte para circuito impreso

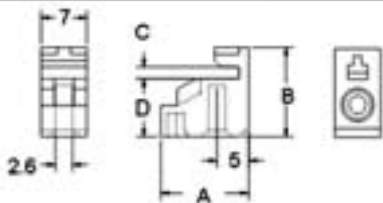
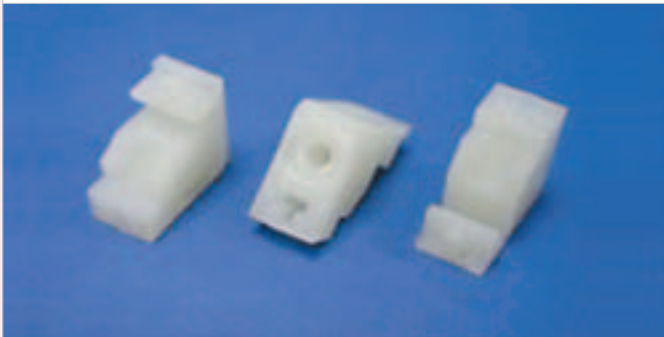

Material: Nylon 66 homologado (UL) 94V-2. Color: Natural.

| Ref. | Dimensiones mm. | | | | |
|-------------|-----------------|------|-----|-----|-----|
| | A | B | C | D | |
| EB-9 | 13.5 | 13.6 | 1.8 | 8.7 | 100 |

Distanciador hexagonal para circuito impreso

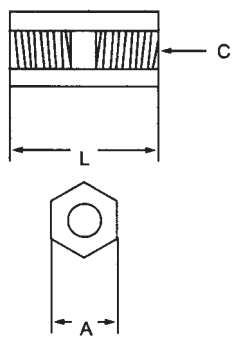

Material: Nylon 66 homologado (UL) 94V-2. Color: Blanco.

| Ref. | Dimensiones mm. | | | |
|----------------|-----------------|-----|---|----------|
| | L | A | C | |
| HTP-306 | 6.0 | 5.5 | 3 | 100/1000 |
| HTP-308 | 8.0 | 5.5 | 3 | 100/1000 |
| HTP-310 | 10.0 | 5.5 | 3 | 100/1000 |
| HTP-312 | 12.7 | 5.5 | 3 | 100/1000 |
| HTP-315 | 15.0 | 5.5 | 3 | 100/1000 |
| HTP-318 | 18.0 | 5.5 | 3 | 100/1000 |
| HTP-320 | 20.0 | 5.5 | 3 | 100/1000 |
| HTP-322 | 22.0 | 5.5 | 3 | 100/1000 |
| HTP-325 | 25.0 | 5.5 | 3 | 100/1000 |
| HTP-330 | 30.0 | 5.5 | 3 | 100/1000 |

Distanciador hexagonal a rosca

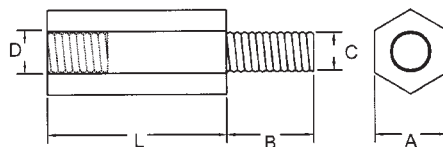

Material: Nylon 66 homologado (UL) 94V-2. Color: Blanco.

| Ref. | Dimensiones mm. | | | | |
|----------------|-----------------|---|-----|------|----------|
| | A | B | C/D | L | |
| HTS-306 | 5.6 | 6 | 3 | 6 | 100/1000 |
| HTS-308 | 5.6 | 6 | 3 | 8 | 100/1000 |
| HTS-310 | 5.6 | 6 | 3 | 10 | 100/1000 |
| HTS-312 | 5.6 | 6 | 3 | 12.7 | 100/1000 |
| HTS-315 | 5.6 | 6 | 3 | 15 | 100/1000 |
| HTS-318 | 5.6 | 6 | 3 | 18 | 100/1000 |
| HTS-320 | 5.6 | 6 | 3 | 20 | 100/1000 |
| HTS-322 | 5.6 | 6 | 3 | 22 | 100/1000 |
| HTS-325 | 5.6 | 6 | 3 | 25 | 100/1000 |
| HTS-330 | 5.6 | 6 | 3 | 30 | 100/1000 |
| HTS-410 | 7 | 6 | 4 | 10.1 | 100/1000 |
| HTS-413 | 7 | 6 | 4 | 13.0 | 100/1000 |
| HTS-415 | 7 | 6 | 4 | 15.0 | 100/1000 |
| HTS-419 | 7 | 6 | 4 | 19.0 | 100/1000 |
| HTS-425 | 7 | 6 | 4 | 25.0 | 100/1000 |



Remache

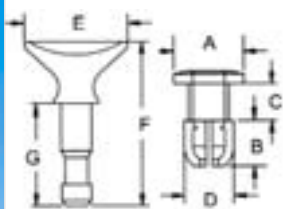

Material: Nylon 66 homologado (UL) 94V-2. Color: ■ Negro.

| Ref. | Dimensiones mm. | | | | | | | |
|----------------|-----------------|-----|-----|-----|------|------|------|----------|
| | A | B | C | D | E | F | G | |
| SR-0813 | 10.7 | 7.0 | 5.5 | 7.8 | 15.8 | 25.1 | 15.6 | 100/1000 |
| SR-0910 | 10.8 | 7.6 | 1.6 | 8.1 | 15.8 | 20.9 | 11.4 | 100/1000 |

Soporte para circuito impreso



Material:
Nylon 66 homologado
(UL) 94V-0.
Color: □ Blanco.

| Ref. | Dimensiones mm. A | |
|-----------------|-------------------|----------|
| LCS-0610 | 9.6 | 100/1000 |

Soporte para circuito impreso

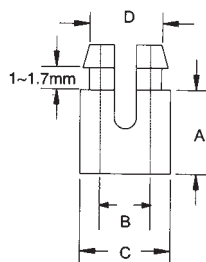

Material: Nylon 66 homologado (UL) 94V-0. Color: □ Blanco.

| Ref. | Dimensiones mm. | | | | |
|--------------|-----------------|-----|-----|-----|----------|
| | A | B | C | D | |
| SPS-6 | 6.5 | 3.9 | 7.0 | 6.0 | 100/1000 |

Soporte para circuito impreso

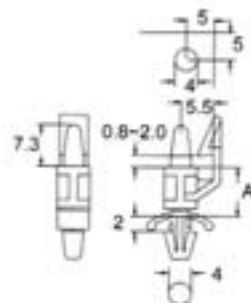

Material:
Nylon 66 homologado
(UL) 94V-2.
Color: □ Blanco.

| Ref. | Dimensiones mm. A | |
|----------------|-------------------|----------|
| LCS-10A | 9 | 100/1000 |

Soporte para circuito impreso

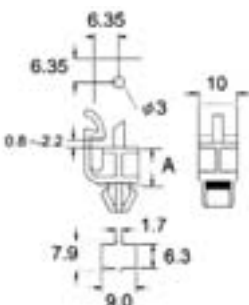

Material: Nylon 66 homologado (UL) 94V-0. Color: □ Blanco.

| Ref. | Dimensiones mm. A | |
|--------------|-------------------|----------|
| GS-10 | 10 | 100/1000 |



Soporte para circuito impreso

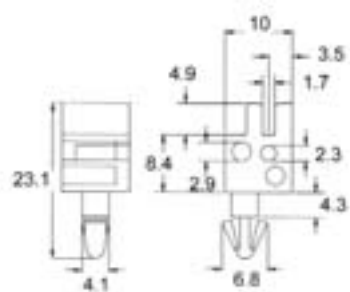

Material:
Nylon 66 homologado (UL) 94V-2.
Color: Blanco.

| Ref. | Dimensiones mm. | |
|---------------|-----------------|----------|
| PCU-23 | Según Figura | 100/1000 |

Remache



SR-0612K

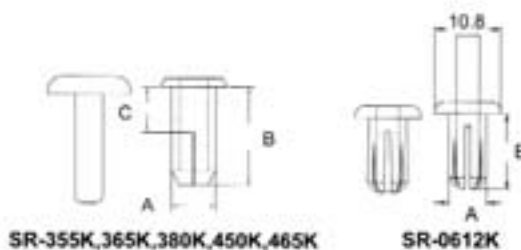

SR-355K,365K,380K,450K,465K

SR-0612K

Material: Nylon 66 homologado (UL) 94V-2. Color: Negro.

| Ref. | Dimensiones mm. | | | |
|-----------------|-----------------|------|----------|------|
| | A | B | C | |
| SR-355K | 3.0 | 5.5 | 2.5-4.0 | 1000 |
| SR-365K | 3.0 | 6.5 | 4.0-5.0 | 1000 |
| SR-380K | 3.0 | 8.0 | 5.5-6.5 | 1000 |
| SR-450K | 4.0 | 5.0 | 2.2-3.5 | 1000 |
| SR-465K | 4.0 | 6.5 | 4.0-5.0 | 1000 |
| SR-0612K | 6.2 | 12.3 | 7.0-10.0 | 1000 |

Remache a rosca

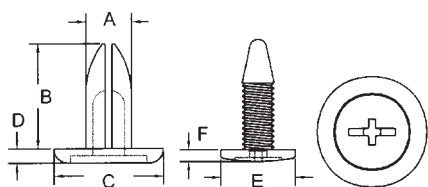

Material: Nylon 66 homologado (UL) 94V-2. Color: Negro.
Montaje según dibujos.

| Ref. | Dimensiones mm. | | | | | | Panel | |
|---------------|-----------------|------|------|------|------|------|-------|----------|
| | A | B | C | D | E | F | | |
| SR-614 | 6.3 | 14.2 | 15.1 | 1.95 | 10.2 | 1.65 | 3-4.5 | 100/1000 |

Remache

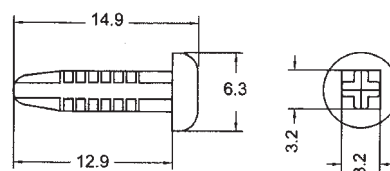

Material: Nylon 66 homologado (UL) 94V-2. Color: Blanco.

| Ref. | Dimensiones mm. | | | | |
|----------------|-----------------|-----|------|------|----------|
| | A | W | H | H1 | |
| SR-0313 | 3.2 | 6.3 | 14.9 | 12.9 | 100/1000 |



Distanciador

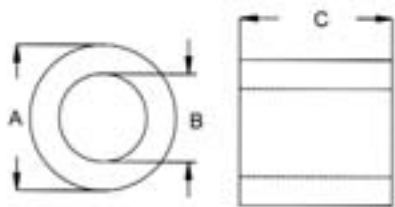

Material: Nylon 66 homologado (UL) 94V-2. Color: Blanco.

| Ref. | Dimensiones mm. | | | |
|-----------------|-----------------|-----|-----|----------|
| | A | B | C | |
| RSP-0203 | 4.0 | 2.1 | 2.5 | 100/1000 |
| RSP-0508 | 7.5 | 4.6 | 8 | 100/1000 |
| RSP-0510 | 10 | 5.4 | 10 | 100/1000 |

Tapa orificios

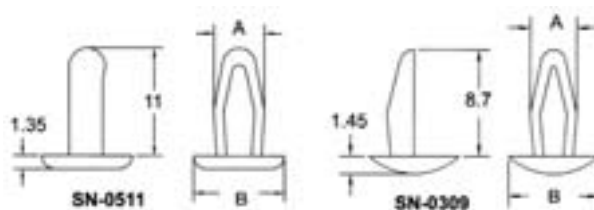

Material: Nylon 66 homologado (UL) 94V-2. Color: Blanco.

| Ref. | Dimensiones mm. | | Panel | |
|----------------|-----------------|-----|-------|----------|
| | A | B | | |
| SN-0511 | 4.9 | 9.2 | 2-5 | 100/1000 |
| SN-0309 | 3.8 | 7.4 | 3-6 | 100/1000 |

Remache

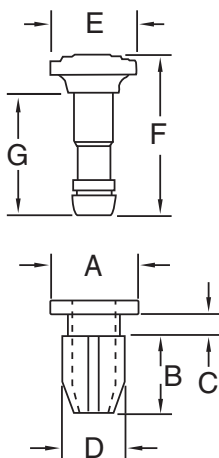

Material: Nylon 66 homologado (UL) 94V-2. Color: Blanco.

| Ref. | Dimensiones mm. | | | | | | | |
|----------------|-----------------|-----|-----|-----|-----|------|------|----------|
| | A | B | C | D | E | F | G | |
| SR-0809 | 8.5 | 7.1 | 1.9 | 6.3 | 7.1 | 13.6 | 11.0 | 100/1000 |
| SR-0810 | 8.5 | 7.1 | 1.9 | 6.3 | 8.1 | 18.4 | 11.5 | 100/1000 |
| SR-1010 | 10.8 | 7.4 | 2.6 | 8.0 | 9.2 | 19.1 | 12.9 | 100/1000 |

Tapa orificios

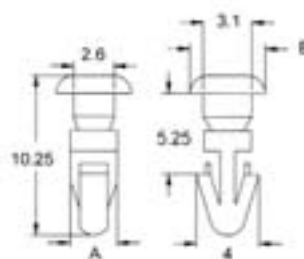

Material: Nylon 66 homologado (UL) 94V-2. Color: Blanco.

| Ref. | Dimensiones mm. | | Panel | |
|----------------|-----------------|---|-------|----------|
| | A | B | | |
| SN-0305 | 3.1 | 5 | 5 | 100/1000 |



Gozne para circuito impreso

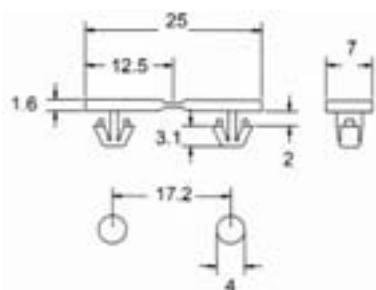

Material: Nylon 66 homologado (UL) 94V-2. Color: Blanco.

| Ref. | Dimensiones mm. | |
|--------------|-----------------|----------|
| PH-17 | Según Figura | 100/1000 |

Distanciador

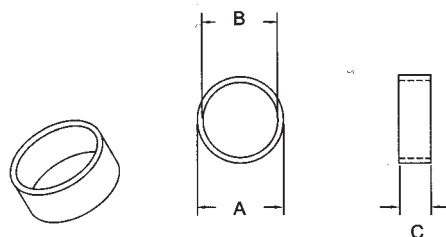

Material: PE. Color: Blanco.

| Ref. | Dimensiones mm. | | | |
|-----------------|-----------------|------|-----|----------|
| | A | B | C | |
| RSP-1607 | 19 | 16.5 | 6.9 | 100/1000 |

"DOOR LOCK"

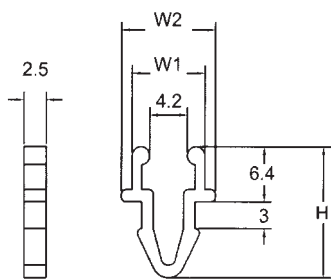

Material: Nylon 66 homologado (UL) 94V-2. Color: Blanco.

| Ref. | Dimensiones mm. | | | |
|-------------|-----------------|------|------|----------|
| | W1 | W2 | H | |
| DR-1 | 8.2 | 10.6 | 14.7 | 100/1000 |

A collection of various plastic fasteners and hardware components, including hooks, clips, and pins, arranged on a green background. The items are primarily white and yellow, with a few black ones. Some are simple hooks, while others are more complex, like a circular wheel-like fastener and a long, thin rod with a hook. The word "FASTENERS" is printed in large, bold, black letters across the bottom of the image.

FASTENERS



Abrazadera para soporte de cables

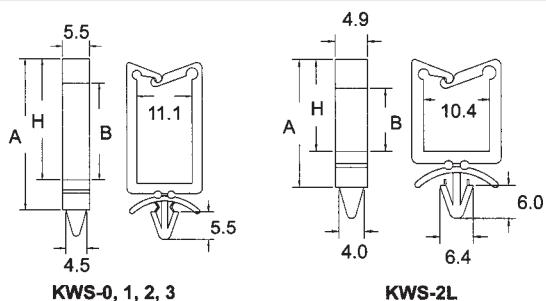

Material: Nylon 66 homologado (UL) 94V-2. Color: Blanco. Para ordenar y posicionar cables. Fijación al chasis por presión. Autoajustable para diferentes grosores de panel. Taladro de instalación: 4,8 mm.

| Ref. | Dimensiones mm. | | | |
|---------------|-----------------|------|------|----------|
| | H | A | B | |
| KWS-0 | 9.2 | 12.7 | 2.8 | 100/1000 |
| KWS-1 | 14.4 | 17.9 | 8.6 | 100/1000 |
| KWS-2 | 23.4 | 26.9 | 18.2 | 100/1000 |
| KWS-2L | 15.7 | 18.0 | 12.5 | 100/1000 |
| KWS-3 | 31.3 | 34.8 | 26.2 | 100/1000 |

Abrazadera para soporte de cables

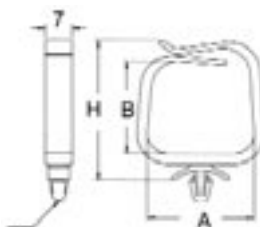

Para orificios de 4,6-4,8 mm.

Material: Nylon 66 homologado (UL) 94V-2. Color: Blanco.

| Ref. | Dimensiones mm. | | | |
|-----------------|-----------------|------|----|----------|
| | H | A | B | |
| PWS-2824 | 35.3 | 27.6 | 24 | 100/1000 |

Abrazadera para soporte de cables

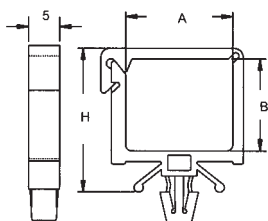

Material: Nylon 66 homologado (UL) 94V-2. Color: Blanco.

| Ref. | Dimensiones mm. | | | |
|-----------------|-----------------|------|----|----------|
| | H | A | B | |
| PWS-1715 | 23 | 16.7 | 15 | 100/1000 |

Abrazadera/distanciador para soporte de cables



Para orificio de 4,5 mm.

Material: Nylon 66 homologado (UL) 94V-2. Color: Blanco.

| Ref. | Dimensiones mm. | | | |
|----------------|-----------------|--|--|----------|
| | Según Figura | | | |
| WS-1522 | Según Figura | | | 100/1000 |



Abrazadera para soporte de cables



Material: Nylon 66 homologado \odot 94V-2. Color: Blanco.
 Para ordenar y posicionar cables. Fijación al chasis por presión. Autoajustable para diferentes grosores de panel. Taladro de instalación: 4,8 mm.

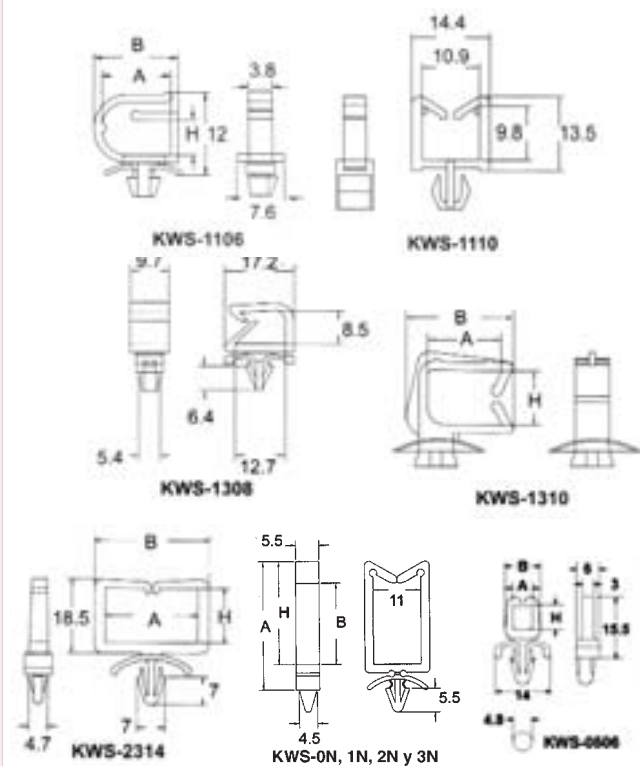

| Ref. | Dimensiones mm. | | | |
|-----------------|-----------------|------|------|----------|
| | H | A | B | |
| KWS-0N | 9.2 | 12.7 | 2.8 | 100/1000 |
| KWS-1N | 14.4 | 17.9 | 8.6 | 100/1000 |
| KWS-2N | 23.4 | 26.9 | 18.2 | 100/1000 |
| KWS-3N | 31.3 | 34.8 | 26.2 | 100/1000 |
| KWS-0506 | 5.4 | 5.0 | 9.0 | 100/1000 |
| KWS-1106 | 5.4 | 10.5 | 13.0 | 100/1000 |
| KWS-1110 | 9.8 | 10.9 | 14.4 | 100/1000 |
| KWS-1308 | 8.5 | 12.7 | 17.2 | 100/1000 |
| KWS-1310 | 9.9 | 13.0 | 18.8 | 100/1000 |
| KWS-2314 | 13.6 | 22.9 | 28.3 | 100/1000 |

Abrazadera/perfil para soporte de cables

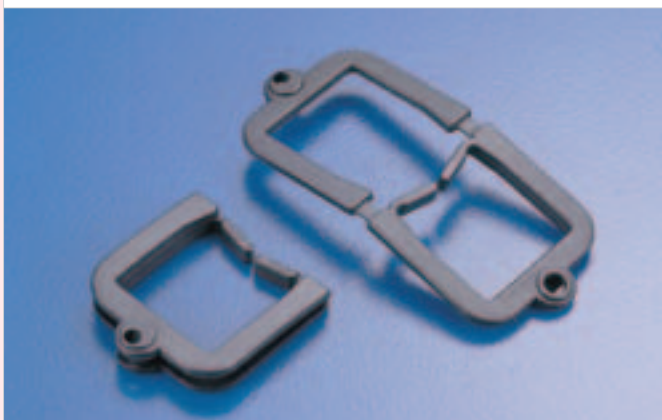

Material: Nylon 66 homologado \odot 94V-2. Color: Negro.

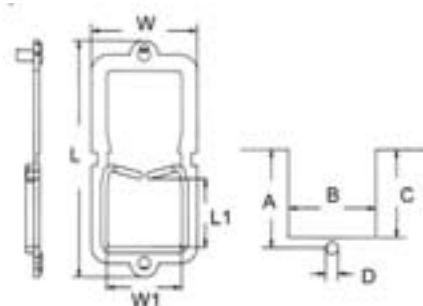

| Ref. | Dimensiones mm. | | | | L | L1 | W | W1 | |
|----------------|-----------------|----|------|---|------|------|------|------|----------|
| | A | B | C | D | | | | | |
| HL-1109 | 15.6 | 14 | 12.3 | 3 | 40 | 8.8 | 18.5 | 11.1 | 100/1000 |
| HL-1817 | 23.5 | 21 | 21 | 3 | 56.8 | 16.8 | 25.4 | 18 | 100/1000 |



Abrazadera/perfil para soporte de cables

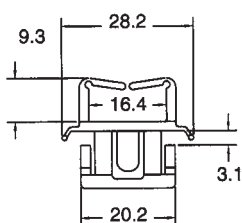

Material: Nylon 66 homologado (UL) 94V-2. Color: Blanco.

| Ref. | Dimensiones mm. | |
|--------------|-----------------|----------|
| ES-16 | Según Figura | 100/1000 |

Abrazadera para soporte de cables

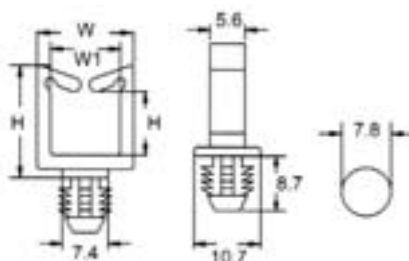

Material: Nylon 66 homologado (UL) 94V-2.
Color: Blanco.

| Ref. | Dimensiones mm. | | | | |
|-----------------|-----------------|------|------|------|----------|
| | H | H1 | W | W1 | |
| BWS-1106 | 13.0 | 5.0 | 15.5 | 11.1 | 100/1000 |
| BWS-1112 | 18.3 | 10.3 | 15.5 | 11.1 | 100/1000 |
| BWS-1120 | 27.2 | 19.2 | 15.5 | 11.1 | 100/1000 |
| BWS-1128 | 35.6 | 27.8 | 15.5 | 11.1 | 100/1000 |

Abrazadera/perfil para soporte de cables

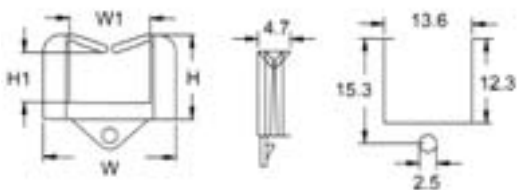

Material: Nylon 66 homologado (UL) 94V-2. Color: Blanco.

| Ref. | Dimensiones mm. | | | | |
|----------------|-----------------|-----|------|------|----------|
| | H | H1 | W | W1 | |
| ES-1207 | 12.3 | 7.3 | 19.3 | 11.8 | 100/1000 |

Grapa soporte cables tipo "N" para circuito impreso

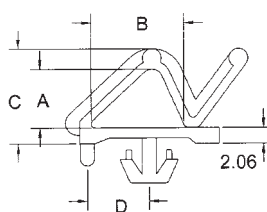

Material: Nylon 66 homologado (UL) 94V-2.
Color: Blanco.
Fijación al chasis por presión.
Tirar de la lengüeta para abrir y posicionar el cable.
Taladro de instalación: 4,8 mm.

| Ref. | Dimensiones mm. | | | | |
|--------------|-----------------|------|------|-----|----------|
| | A | B | C | D | |
| PCC-1 | 6.3 | 10.6 | 10.7 | 7.5 | 100/1000 |



Abrazadera para soporte de cables

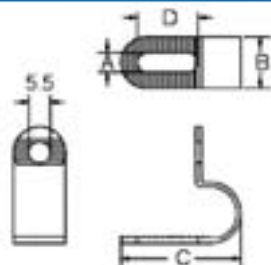

Material: Nylon 66 homologado (UL) 94V-2. Color: Blanco.

| Ref. | Dimensiones mm. | | | | Ø máx. mm. | |
|----------------|-----------------|----|------|------|------------|-----|
| | A | B | C | D | | |
| PC-0406 | 5 | 13 | 23.5 | 10.4 | 4.8~6.4 | 100 |
| PC-0609 | 5 | 13 | 30.5 | 16.1 | 6.4~9.5 | 100 |
| PC-0914 | 5 | 13 | 40 | 20.7 | 9.5~14.3 | 100 |

Clip sujeción de cables a presión

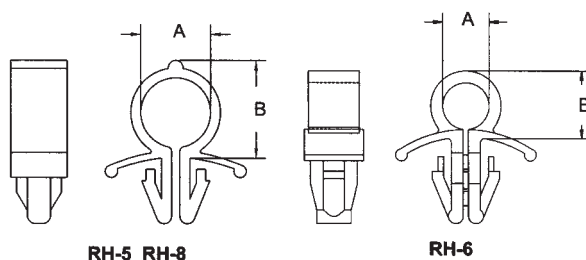

Material: Nylon 66 homologado (UL) 94V-2. Color: Blanco.

| Ref. | Dimensiones mm. | | Taladro de montaje mm. | |
|-------------|-----------------|-----|------------------------|----------|
| | A | B | | |
| RH-5 | 5.1 | 8.0 | 5.5 | 100/1000 |
| RH-6 | 6.2 | 9.5 | 8 | 100/1000 |
| RH-8 | 7.5 | 8.8 | 6.2 | 100/1000 |

Abrazadera

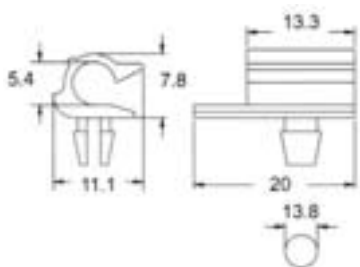

Material: Nylon 66 homologado (UL) 94V-2. Color: Blanco.

| Ref. | Dimensiones mm. | |
|--------------|-----------------|----------|
| LWS-5 | Según Figura | 100/1000 |

Abrazadera



Material:
Nylon 66 homologado
(UL) 94V-2.
Color: Blanco.

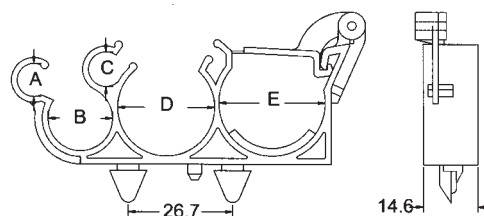

| Ref. | Dimensiones mm. | | | | | |
|--------------|-----------------|------|-----|------|----|----------|
| | A | B | C | D | E | |
| TWS-3 | 8.4 | 16.3 | 8.8 | 24.8 | 27 | 100/1000 |



Abrazadera

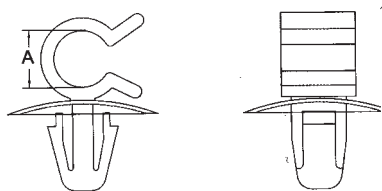

Material: Nylon 66 homologado (UL) 94V-2. Color: Blanco.

| Ref. | Dimensiones mm. A | Taladro de montaje mm. | |
|--------------|----------------------|------------------------|----------|
| RWS-6 | 6.2 | 6.0 | 100/1000 |

Clip sujeción de cables a presión doble

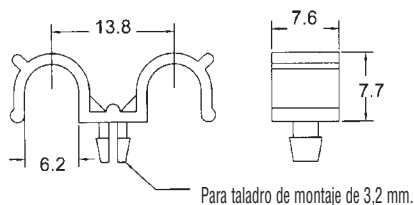

Material: Nylon 66 homologado (UL) 94V-2. Color: Blanco.

| Ref. | Dimensiones mm. | |
|-------------|-----------------|----------|
| DR-6 | Según figura | 100/1000 |

Brida -twist- para circuito impreso

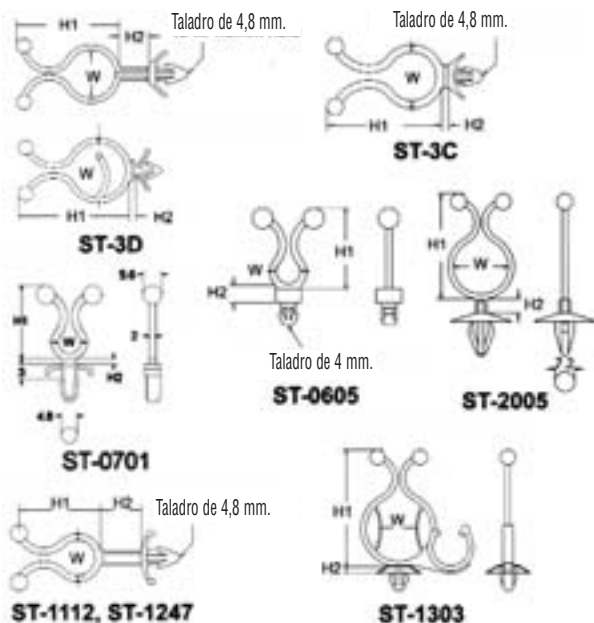

Material: Nylon 66 homologado (UL) 94V-2. Color: Blanco.

Fijación por presión. Colocar los cables en la brida y cerrarla cruzando los extremos. Taladro de instalación: 4,8 mm.

| Ref. | Dimensiones mm. | | | |
|----------------|-----------------|------|------|----------|
| | H1 | H2 | W | |
| ST-1 | 21.0 | 31.0 | 6.0 | 100/1000 |
| ST-2 | 30.0 | 18.0 | 11.0 | 100/1000 |
| ST-3 | 30.0 | 4.0 | 11.0 | 100/1000 |
| ST-3B | 30.8 | 3.0 | 11.0 | 100/1000 |
| ST-3C | 30.7 | 2.3 | 14.8 | 100/1000 |
| ST-3D | 34.9 | 2.0 | 18.2 | 100/1000 |
| ST-4S | 30.0 | 12.7 | 11.0 | 100/1000 |
| ST-4 | 33.7 | 8.7 | 15.2 | 100/1000 |
| ST-0560 | 21.6 | 58.3 | 5.0 | 100/1000 |
| ST-0605 | 19.9 | 4.7 | 6.2 | 100/1000 |
| ST-0701 | 22.0 | 1.3 | 4.8 | 100/1000 |
| ST-1112 | 25.3 | 12.2 | 11.0 | 100/1000 |
| ST-1247 | 26.3 | 46.6 | 12.0 | 100/1000 |
| ST-1303 | 45.0 | 3.0 | 13.5 | 100/1000 |
| ST-1602 | 32.0 | 2.5 | 16.0 | 100/1000 |
| ST-2005 | 38.3 | 5.1 | 20.0 | 100/1000 |
| ST-2403 | 43.2 | 3.1 | 24.0 | 100/1000 |



Soporte para cable

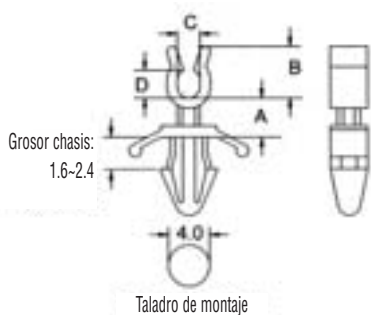

Material: Nylon 66 homologado (UL) 94V-2. Color: Blanco.

| Ref. | Dimensiones mm. | | | | |
|--------------|-----------------|-----|-----|-----|----------|
| | A | B | C | D | |
| RCS-4 | 4.0 | 5.0 | 2.2 | 2.6 | 100/1000 |

Brida -twist- doble

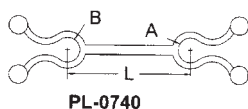
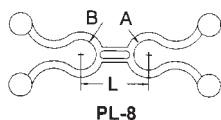

Material: Nylon 66 homologado (UL) 94V-2. Color: Negro.

| Ref. | Dimensiones mm. | | | |
|----------------|-----------------|-----|----|----------|
| | A | B | L | |
| PL-8 | 8 | 8 | 18 | 100/1000 |
| PL-0740 | 7.5 | 7.5 | 40 | 100/1000 |

Brida -twist-

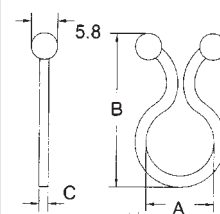

Material: Nylon 66 homologado (UL) 94V-2. Color standard: Blanco. Otros colores bajo demanda. Introducir los cables en la brida y cruzar los extremos para cerrarla. **Económicas**

| Ref. | Dimensiones mm. | | | Usos diámetros | |
|--------------|-----------------|------|-----|----------------|----------|
| | A | B | C | | |
| TT-05 | 5.1 | 20.6 | 1.8 | 4-7 | 100/1000 |
| TT-08 | 8.0 | 25.4 | 1.8 | 7-10 | 100/1000 |
| TT-11 | 11.3 | 29.3 | 1.8 | 10-13 | 100/1000 |
| TT-15 | 15.0 | 34.0 | 2 | 13-16.5 | 100/1000 |
| TT-18 | 18.6 | 40.0 | 2 | 16.5-20 | 100/1000 |
| TT-24 | 24.0 | 45.5 | 2 | 20-26 | 100/1000 |

Brida -twist- con soporte adhesivo

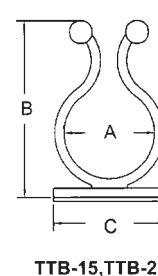
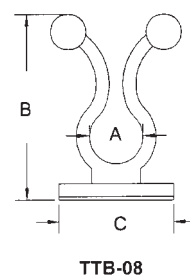
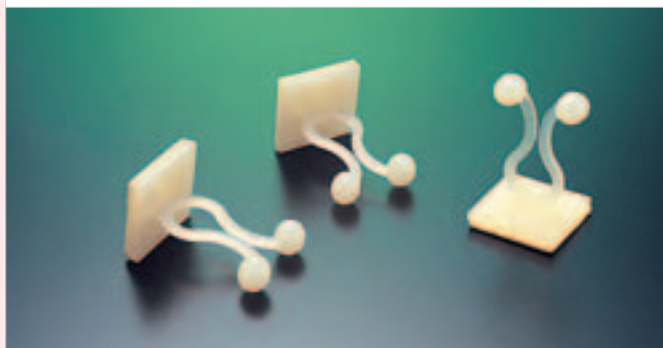

Material: Nylon 66 homologado (UL) 94V-2. Color: Blanco.

| Ref. | Dimensiones mm. | | | Usos diámetros | |
|---------------|-----------------|------|------|----------------|----------|
| | A | B | C | | |
| TTB-08 | 7.9 | 27.5 | 17.4 | 7-10 | 100/1000 |
| TTB-15 | 14.8 | 35.2 | 22.0 | 10-15 | 100/1000 |
| TTB-20 | 20.6 | 40.0 | 25.5 | 15-20 | 100/1000 |



Clip sujeción de cables con soporte adhesivo

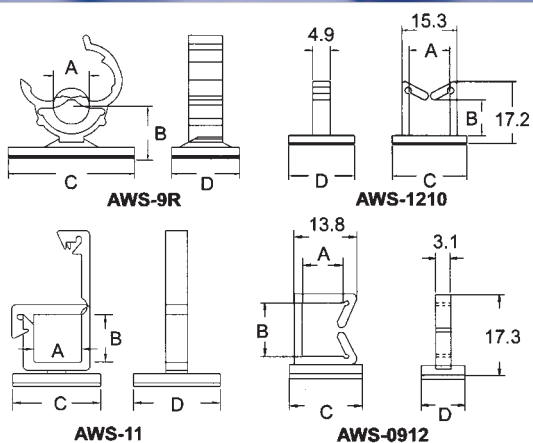

Material: Nylon 66 homologado (UL) 94V-2. Color: Blanco.

| Ref. | Dimensiones mm. | | | | |
|-----------------|-----------------|------|------|------|----------|
| | A | B | C | D | |
| AWS-11 | 11.2 | 11.0 | 20.0 | 19.8 | 100/1000 |
| AWS-9R | 8.5 | 13.6 | 29.8 | 16.0 | 100/1000 |
| AWS-1210 | 11.3 | 10.0 | 20.7 | 18.3 | 100/1000 |
| AWS-0912 | 9.0 | 11.6 | 15.8 | 9.5 | 100/1000 |

Protector para transistor

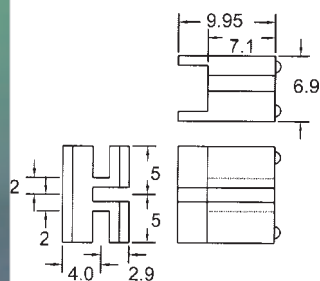
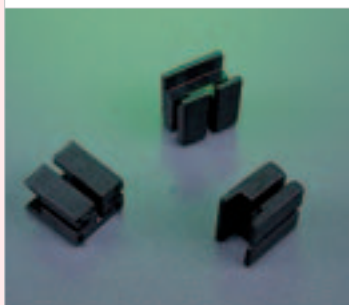

Material: Nylon 66 homologado (UL) 94V-2. Color: Negro. Protección de los transistores ante cortocircuitos. Indicado para control de temperaturas.

| Ref. | Dimensiones mm. | |
|-------------|-----------------|----------|
| TH-1 | Según Figura | 100/1000 |

Distanciador perimetral de cables

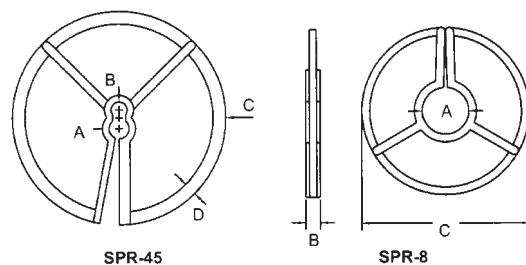

Material: Nylon 66 homologado (UL) 94V-0. Color: Blanco.

| Ref. | Dimensiones mm. | | | | |
|---------------|-----------------|-----|----|-----|----------|
| | A | B | C | D | |
| SPR-8 | 7.8 | 2.5 | 28 | - | 100/1000 |
| SPR-45 | 4.6 | 3.7 | 49 | 2.9 | 100/1000 |

Protector para transistor

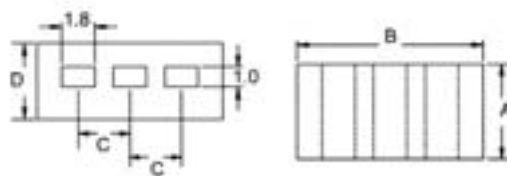

Material: Nylon 66 homologado (UL) 94V-2. Color: Blanco.

| Ref. | Dimensiones mm. | | | | |
|--------------|-----------------|------|-----|---|----------|
| | A | B | C | D | |
| THR-2 | 5 | 10.1 | 2.8 | 4 | 100/1000 |



Tapa para transistor

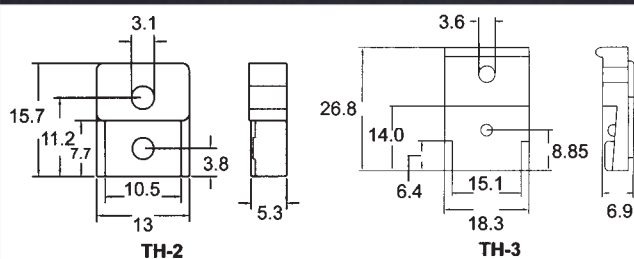

Material: Nylon 66 homologado (UL) 94V-0. Color: Blanco.
Protección de las patas de los transistores contra roturas o cortocircuitos.

| Ref. | Dimensiones mm. | |
|-------------|-----------------|----------|
| TH-2 | Según figura | 100/1000 |
| TH-3 | Según figura | 100/1000 |

Arandela

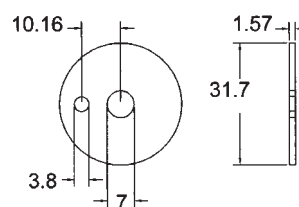

Material: Nylon 66 homologado (UL) 94V-2. Color: Blanco.

| Ref. | Dimensiones mm. | |
|----------------|-----------------|----------|
| WR-3207 | Según Figura | 100/1000 |

Porta-termistor NTC

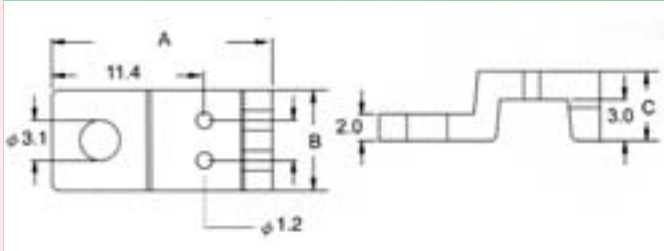

Material: P.B.T. homologado (UL) 94V-0. Color: Blanco.

| Ref. | Dimensiones mm. | | | |
|--------------|-----------------|-----|-----|----------|
| | A | B | C | |
| TRH-7 | 16.5 | 7.5 | 5.1 | 100/1000 |

Porta-transistor

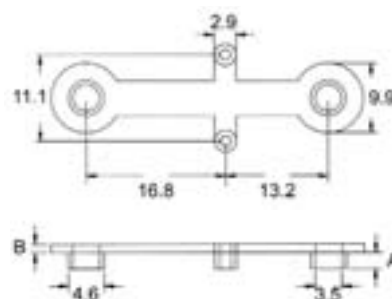

Material: Nylon 66 homologado (UL) 94V-2. Color: Blanco.

| Ref. | Dimensiones mm. | | |
|-------------|-----------------|-----|----------|
| | A | B | |
| TR-3 | 2.1 | 1.1 | 100/1000 |



Arandela distanciadora

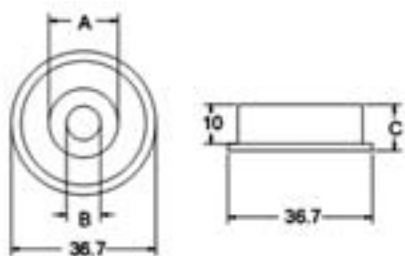

Material: PE. Color: Blanco.

| Ref. | Dimensiones mm. | | | |
|-----------------|-----------------|-----|------|-----|
| | A | B | C | |
| HBW-1808 | 18 | 8.6 | 11.7 | 100 |

Arandela distanciadora cónica

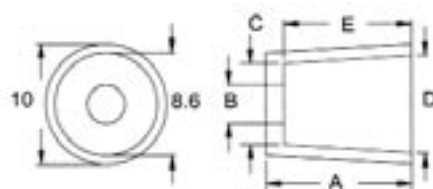

Material: Nylon 66 homologado (UL) 94V-2. Color: Blanco.

| Ref. | Dimensiones mm. | | | | | |
|---------------|-----------------|-----|-----|-----|------|----------|
| | A | B | C | D | E | |
| CDW-12 | 12.2 | 3.3 | 6.9 | 8.3 | 10.7 | 100/1000 |

Arandela

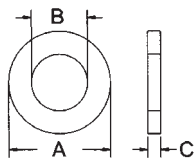
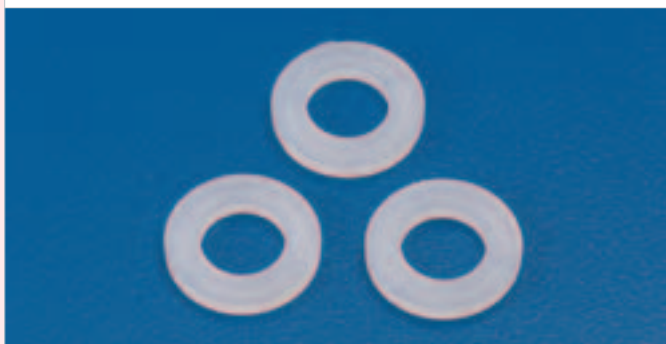

Material: Nylon 66 homologado (UL) 94V-2. Color: Blanco.

| Ref. | Dimensiones mm. | | | |
|----------------|-----------------|-----|-----|----------|
| | A | B | C | |
| WR-0503 | 4.5 | 2.5 | 0.8 | 100/1000 |
| WR-0603 | 6.0 | 3.0 | 0.8 | 100/1000 |
| WR-1206 | 12.0 | 6.0 | 1.5 | 100/1000 |
| WR-1208 | 12.0 | 8.0 | 1.5 | 100/1000 |

Arandela distanciadora

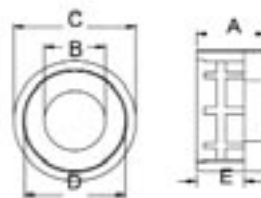

Material: Nylon 66 homologado (UL) 94V-2. Color: Blanco.

| Ref. | Dimensiones mm. | | | | | |
|--------------|-----------------|---|---|-----|-----|----------|
| | A | B | C | D | E | |
| RW-45 | 4.5 | 8 | 4 | 6.5 | 3.1 | 100/1000 |



Arandela/sopORTE para transistor

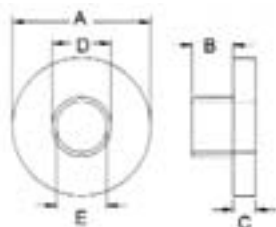

Material: Nylon 66 homologado (UL) 94V-2. Color: Blanco.

| Ref. | Dimensiones mm. | | | | | |
|----------------|-----------------|-----|-----|------|-----|----------|
| | A | B | C | D | E | |
| TW-63A | 6.0 | 8.1 | 0.5 | 3.5 | 2.8 | 100/1000 |
| TW-63B | 6.0 | 1.4 | 1.2 | 3.5 | 2.9 | 100/1000 |
| TW-63C | 6.0 | 2.3 | 1.7 | 3.5 | 2.9 | 100/1000 |
| TW-63D | 6.0 | 3.2 | 1.9 | 3.5 | 2.9 | 100/1000 |
| TW-63E | 6.1 | 2.6 | 2.0 | 3.5 | 2.9 | 100/1000 |
| TW-63F | 6.3 | 2.0 | 1.3 | 3.4 | 2.9 | 100/1000 |
| TW-73A | 6.6 | 1.8 | 3.0 | 4.2 | 3.2 | 100/1000 |
| TW-73B | 6.9 | 2.5 | 1.3 | 3.6 | 2.9 | 100/1000 |
| TW-83A | 7.7 | 3.7 | 1.3 | 5.8 | 3.1 | 100/1000 |
| TW-83B | 7.8 | 5.6 | 1.2 | 3.6 | 2.9 | 100/1000 |
| TW-83C | 7.8 | 0.9 | 2.0 | 4.3 | 3.2 | 100/1000 |
| TW-83D | 8.0 | 2.3 | 1.3 | 3.5 | 2.9 | 100/1000 |
| TW-83E | 7.8 | 1.2 | 3.7 | 5.9 | 3.2 | 100/1000 |
| TW-133A | 12.7 | 1.7 | 1.5 | 7.9 | 3.7 | 100/1000 |
| TW-163A | 16.0 | 2.0 | 1.5 | 6.0 | 3.2 | 100/1000 |
| TW-189A | 18.0 | 1.5 | 3.3 | 12.4 | 9.3 | 100/1000 |

Porta LED

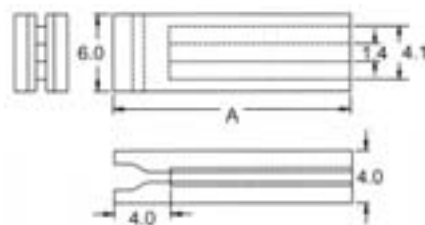

Material: Nylon 66 homologado (UL) 94V-2. Color: Blanco.

| Ref. | Dimensiones mm. A | |
|--------------|-------------------|----------|
| LK-5 | 5 | 100/1000 |
| LK-18 | 18 | 100/1000 |

Arandela/sopORTE para transistor

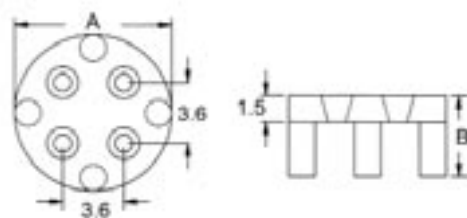

Material: Nylon 66 homologado (UL) 94V-2. Color: Blanco.

| Ref. | Dimensiones mm. | | |
|--------------|-----------------|-----|----------|
| | A | B | |
| TRW-5 | 8.9 | 4.6 | 100/1000 |



Porta LED

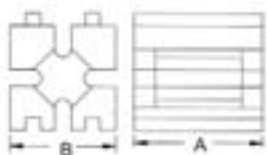

Material: Nylon 66 homologado (UL) 94V-2. Color: Blanco.

| Ref. | Dimensiones mm. | | |
|--------------|-----------------|---|----------|
| | A | B | |
| LX-3 | 3 | 5 | 100/1000 |
| LX-6 | 6 | 5 | 100/1000 |
| LX-12 | 12 | 5 | 100/1000 |

Porta LED

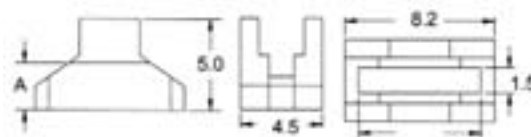

Material: Nylon 66 homologado (UL) 94V-2. Color: Blanco.

| Ref. | Dimensiones mm. A | | |
|-------------|-------------------|--|----------|
| | A | | |
| LQ-2 | 2.6 | | 100/1000 |

Porta LED

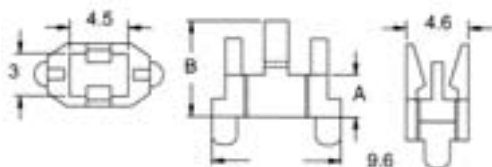
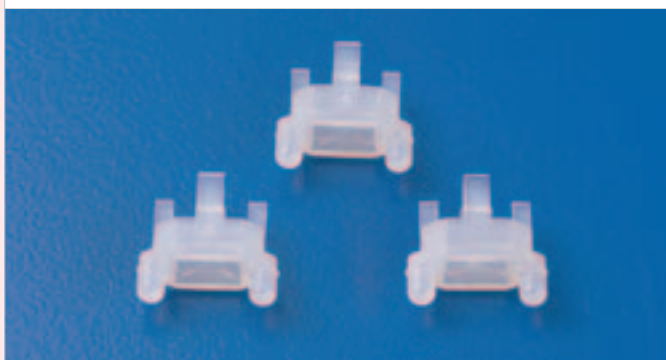

Material: Nylon 66 homologado (UL) 94V-2. Color: Blanco.

| Ref. | Dimensiones mm. | | |
|--------------|-----------------|-----|----------|
| | A | B | |
| LQT-3 | 3.1 | 6.6 | 100/1000 |

Porta LED

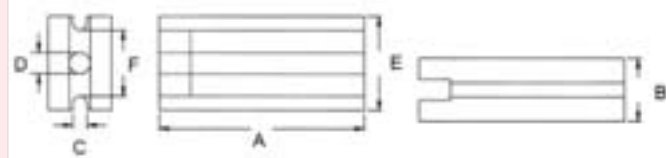

Material: Nylon 66 homologado (UL) 94V-2. Color: Blanco.

| Ref. | Dimensiones mm. | | | | | | |
|--------------|-----------------|-----|---|-----|-----|-----|----------|
| | A | B | C | D | E | F | |
| LE-3 | 3.1 | 3.6 | 1 | 1.2 | 7.2 | 3.6 | 100/1000 |
| LE-6 | 6.0 | 3.6 | 1 | 1.2 | 7.1 | 3.9 | 100/1000 |
| LE-13 | 12.9 | 4.0 | 1 | 1.4 | 6.0 | 3.9 | 100/1000 |



Porta LED

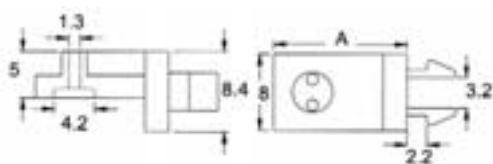

Material: Nylon 66 homologado (UL) 94V-2. Color: Blanco.

| Ref. | Dimensiones mm. A | |
|--------------|-------------------|----------|
| LY-14 | 14.1 | 100/1000 |

Porta LED

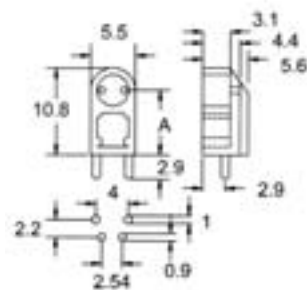
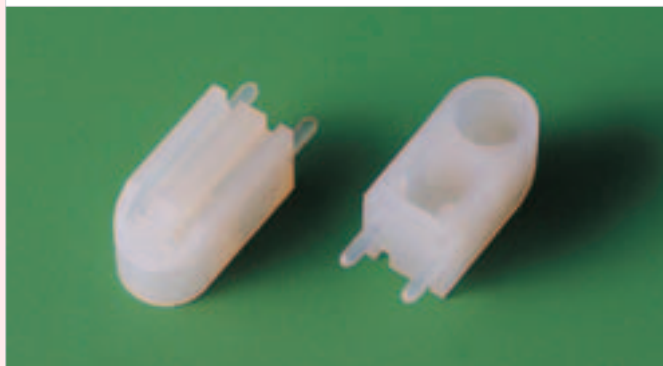

Material: Nylon 66 homologado (UL) 94V-2. Color: Blanco.

| Ref. | Dimensiones mm. A | |
|-------------|-------------------|----------|
| LG-8 | 7.8 | 100/1000 |

Porta LED

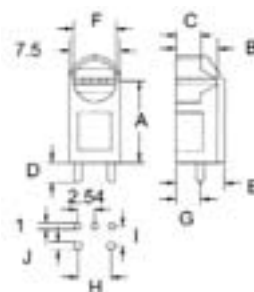

Material: Nylon 66 homologado (UL) 94V-2. Color: Blanco.

| Ref. | Dimensiones mm. | | | | | | | | | | |
|---------------|-----------------|-----|-----|---|-----|-----|-----|---|---|-----|----------|
| | A | B | C | D | E | F | G | H | I | J | |
| LG3-12 | 12 | 2.5 | 3.6 | 3 | 7.1 | 6.3 | 3.5 | 5 | 3 | 1.2 | 100/1000 |
| LG3-18 | 17.5 | 2.4 | 3.7 | 3 | 7.1 | 6.3 | 3.5 | 5 | 3 | 1.2 | 100/1000 |



Porta LED

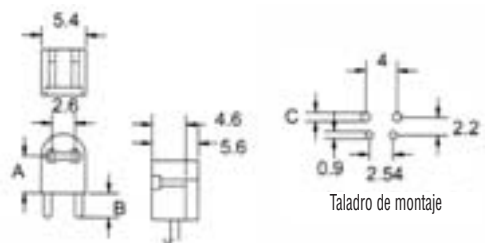

Material: Nylon 66 homologado (UL) 94V-2. Color: Blanco.

| Ref. | Dimensiones mm. | | | |
|-------------|-----------------|-----|-----|----------|
| | A | B | C | |
| LH-4 | 4.5 | 2.5 | 1.1 | 100/1000 |

Porta LED

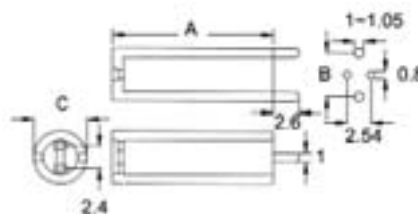

Material: Nylon 66 homologado (UL) 94V-2. Color: Blanco.

| Ref. | Dimensiones mm. | | | |
|---------------|-----------------|-----|-----|----------|
| | A | B | C | |
| LDT-17 | 17.2 | 4.7 | 5.7 | 100/1000 |

Porta LED

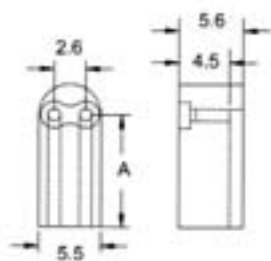
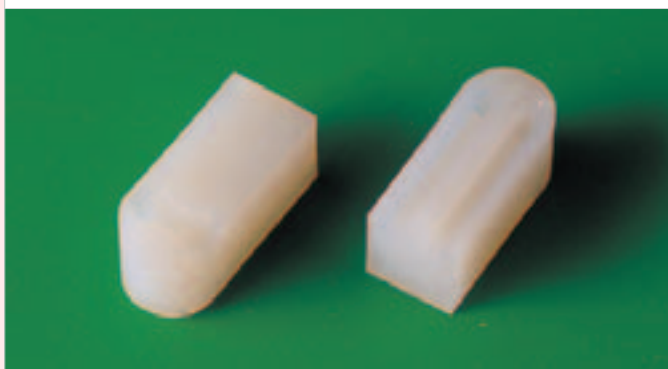

Material: Nylon 66 homologado (UL) 94V-2. Color: Blanco.

| Ref. | Dimensiones mm. A | | |
|---------------|-------------------|--|----------|
| | A | | |
| LHN-10 | 10 | | 100/1000 |

Porta LED

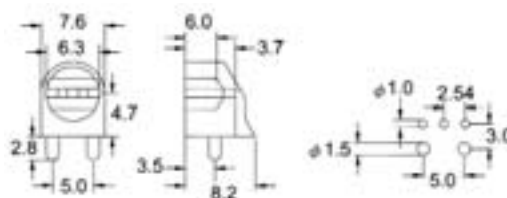

Material: Nylon 66 homologado (UL) 94V-2. Color: Blanco.

| Ref. | Dimensiones mm. A | | |
|--------------|-------------------|--|----------|
| | A | | |
| PLK-5 | Según Figura | | 100/1000 |



Porta LED

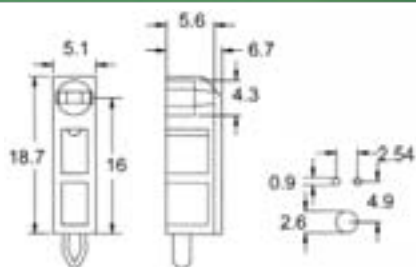

Material: Nylon 66 homologado (UL) 94V-2. Color: Blanco.

| Ref. | Dimensiones mm. | |  |
|---------------|-----------------|------|---|
| | A | B | |
| PLM-16 | 16 | 18.7 | 100/1000 |

Porta LED

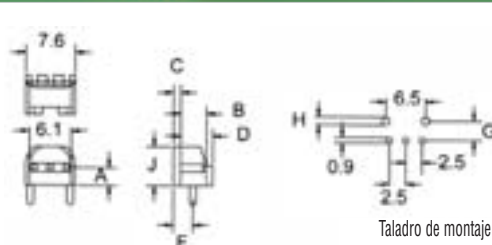

Material: Nylon 66 homologado (UL) 94V-2. Color: Blanco.

| Ref. | Dimensiones mm. | | | | | | | |  |
|--------------|-----------------|---|---|---|---|---|-----|---|---|
| | A | B | C | D | F | G | H | J | |
| LHK-3 | 2.7 | 4 | 1 | 5 | 3 | 3 | 3.2 | 6 | 100/1000 |

Porta-condensador

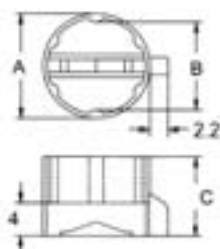

Material: PP. Color: Blanco.

| Ref. | Dimensiones mm. | | |  |
|---------------|-----------------|------|-----|---|
| | A | B | C | |
| CAP-10 | 12.5 | 10.4 | 9.5 | 100/1000 |

Conector "U"



Diseñado para hacer conexiones de hasta 5 UL sin necesidad de pelar cables.

| Ref. | Dimensiones | |  |
|-----------|-------------|-------|---|
| | mm. | AWG | |
| UY | 1.52 | 19~24 | 100 |



Tornillos de plástico con cabezal hexagonal



Material: Nylon 66 homologado (UL) 94V-2.

Diseñado para uso en equipos electrónicos e informáticos, donde se requiere mayor aislamiento, poco peso, etc.

Color: Natural.

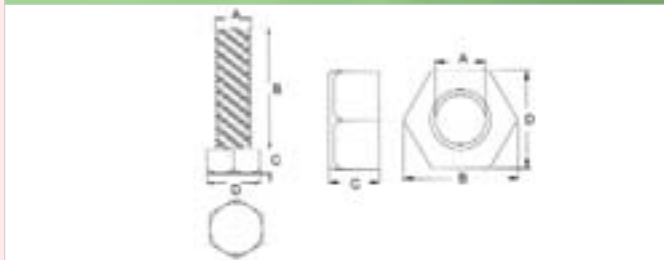

| Ref. | Dimensiones mm. | | | | Paso mm. | |
|-----------------|-----------------|------|-----|------|----------|-----|
| | A | B | C | D | | |
| PF-820N | 8 | 20 | 5.4 | 11.7 | 1.25 | 100 |
| PF-830N | 8 | 30 | 5.4 | 11.7 | 1.25 | 100 |
| PF-840N | 8 | 40 | 5.4 | 11.7 | 1.25 | 100 |
| PF-1030N | 10 | 30 | 5.5 | 13.5 | 1.5 | 100 |
| PF-1040N | 10 | 40 | 5.5 | 13.6 | 1.5 | 100 |
| PN-8N | 8 | 14.5 | 6.4 | 12.8 | 1.25 | 100 |
| PN-10N | 10 | 19.2 | 8 | 16.7 | 1.5 | 100 |

Tornillos de plástico con cabezal redondo



Material: Nylon 66 homologado (UL) 94V-2 ó Policarbonato transparente

Diseñado para uso en equipos electrónicos e informáticos, donde se requiere mayor aislamiento, poco peso, etc. Color: Natural.

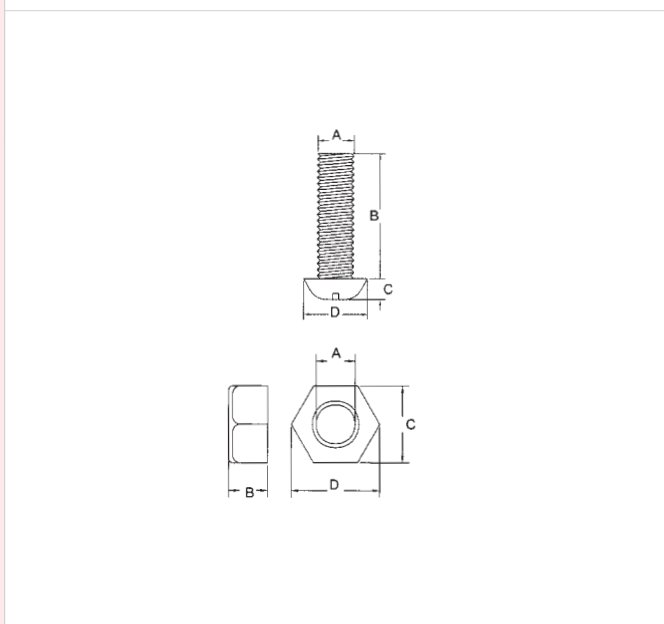

| Ref. | Dimensiones mm. | | | | Paso mm. | |
|-----------------|-----------------|------|-----|-----|----------|------|
| | A | B | C | D | | |
| PF-306K | 3 | 6 | 2.5 | 6 | 0.5 | 1000 |
| PF-308K | 3 | 8 | 2.5 | 6 | 0.5 | 1000 |
| PF-310K | 3 | 10 | 2.5 | 6 | 0.5 | 1000 |
| PF-312K | 3 | 12 | 2.5 | 6 | 0.5 | 1000 |
| PF-408K | 4 | 8 | 2.6 | 7.5 | 0.7 | 1000 |
| PF-410K | 4 | 10 | 2.6 | 7.5 | 0.7 | 1000 |
| PF-412K | 4 | 12 | 2.6 | 7.5 | 0.7 | 1000 |
| PF-414K | 4 | 14 | 2.6 | 7.5 | 0.7 | 1000 |
| PF-420NK | 4 | 20 | 2.6 | 7.5 | 0.7 | 1000 |
| PF-425NK | 4 | 25 | 2.6 | 7.5 | 0.7 | 1000 |
| PF-520NK | 5 | 20 | 3.5 | 9 | 0.8 | 1000 |
| PF-530NK | 5 | 30 | 3.5 | 9 | 0.8 | 1000 |
| PF-540NK | 5 | 40 | 3.5 | 9 | 0.8 | 1000 |
| PF-620NK | 6 | 20 | 4 | 10 | 1 | 1000 |
| PF-630NK | 6 | 30 | 4 | 10 | 1 | 1000 |
| PF-640NK | 6 | 40 | 4 | 10 | 1 | 1000 |
| PN-3K | 3 | 0.4 | 2.4 | 5.6 | 0.5 | 1000 |
| PN-4K | 4 | 8.1 | 3.2 | 7 | 0.7 | 1000 |
| PN-4NK | 4 | 8.1 | 3.2 | 7 | 0.7 | 1000 |
| PN-5NK | 5 | 9.2 | 4 | 8 | 0.8 | 1000 |
| PN-6NK | 6 | 11.5 | 5 | 10 | 1 | 1000 |

TORNILLO=PF

TUERCA=PN





CANALETAS



Canaleta (agujero abierto)

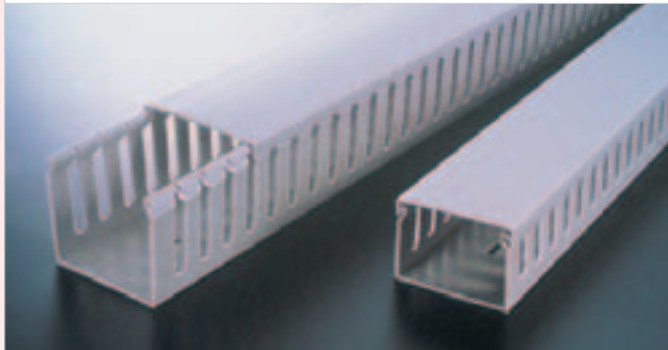

Agujero: 8 mm. en todas las referencias excepto MD-6.5, MD-6.7 y MD-8 que tienen el agujero de 10mm.

Material: Resistente a grandes impactos, autoextinguible, en PVC antideformable.

Color: ■ Gris.

Temperatura máxima: 85° C.

Para utilizar en todas aquellas aplicaciones en las que la protección del cable sea imprescindible como paneles de control, etc... Lleva ranuras paralelas en los dos lados para facilitar el corte. Para colores, medidas y largos especiales, consultar cantidad mínima.

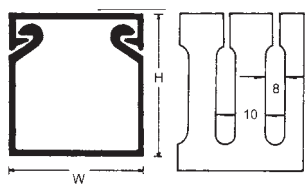

MD agujero: 8 mm.

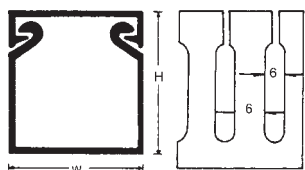

KD agujero: 6 mm.

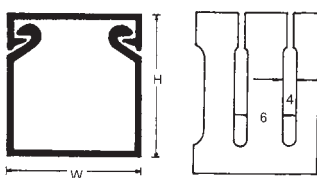

HD agujero: 4 mm.

con agujero de 6 mm. bajo demanda.

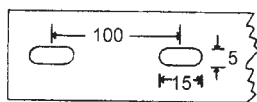

Agujero de fijación

Para anchos: 25 mm., 33 mm., 40 mm., 45 mm., 50 mm., 60 mm., 65 mm.

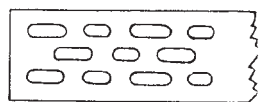

Para anchos: 72 mm., 80 mm., 100mm., 150 mm.

Agujeros de 50 mm. bajo demanda.

| Ref. Agujero 8mm. | Ref. Agujero 6mm. | Ref. Agujero 4mm. | Dimensiones W x H mm. | Para número de cables | Largo |
|----------------------|----------------------|----------------------|--------------------------|--------------------------|-------|
| MD-0.5L | | HD-0.5L | 15x25 | 5 -12 uds. | 2 m |
| MD-0.7L | | HD-0.7L | 20x20 | 5 -12 uds. | 2 m |
| MD-0L | | HD-0L | 25x25 | 10-25 uds. | 2 m |
| MD-1L | KD-1L | HD-1L | 25x45 | 20-25 uds. | 2 m |
| MD-1.1L | | HD-1.1L | 30x30 | 15-25 uds. | 2 m |
| MD-1.2L | KD-1.2L | HD-1.2L | 33x33 | 25-45 uds. | 2 m |
| MD-1.5L | KD-1.5L | HD-1.5L | 33x45 | 40-55 uds. | 2 m |
| MD-2L | KD-2L | HD-2L | 45x45 | 60-70 uds. | 2 m |
| MD-2.2L | | HD-2.2L | 50x50 | 80-90 uds. | 2 m |
| MD-2.5L | KD-2.5L | HD-2.5L | 65x45 | 110-120 uds. | 2 m |
| MD-3L | KD-3L | HD-3L | 33x65 | 60-75 uds. | 2 m |
| MD-4L | KD-4L | HD-4L | 25x65 | 40-45 uds. | 2 m |
| MD-5L | KD-5L | HD-5L | 45x65 | 110-120 uds. | 2 m |
| MD-5.5L | KD-5.5L | HD-5.5L | 60x60 | 120-135 uds. | 2 m |
| MD-5.7L | KD-5.7L | HD-5.7L | 65x65 | 180-200 uds. | 2 m |
| MD-6L | | | 72x64 | 200-220 uds. | 2 m |
| MD-6.5L | | | 33x100 | 180-200 uds. | 2 m |
| MD-6.6L | | | 37.5x100 | 180-200 uds. | 2 m |
| MD-6.7L | KD-6.7L | | 48x100 | 215-250 uds. | 2 m |
| MD-6.8L | | | 55x100 | 220-260 uds. | 2 m |
| MD-6.9L | | | 75x75 | 200-250 uds. | 2 m |
| MD-7L | | | 70x100 | 250-300 uds. | 2 m |
| MD-7.1L | | | 75x100 | 260-320 uds. | 2 m |
| MD-7.2L | | | 100x50 | 200-250 uds. | 2 m |
| MD-7.5L | | | 100x75 | 260-320 uds. | 2 m |
| MD-8L | | HD-8L | 100x100 | 300-400 uds. | 2 m |
| MD-9L | | | 120x75 | 280-380 uds. | 2 m |
| MD-10L | | | 150x75 | 335-500 uds. | 2 m |
| MD-12L | | | 150x100 | 450-600 uds. | 2 m |
| MD-15L | | | 200x100 | 600-800 uds. | 2 m |
| MD-21L | | | 200x150 | 1040-1200 uds. | 2 m |
| MD-22L | | | 200x200 | 1200-1600 uds. | 2 m |
| MD-30L | | | 300x100 | 1040-1200 uds. | 2 m |



Canaleta (agujero abierto)



E 97527



LR 82854

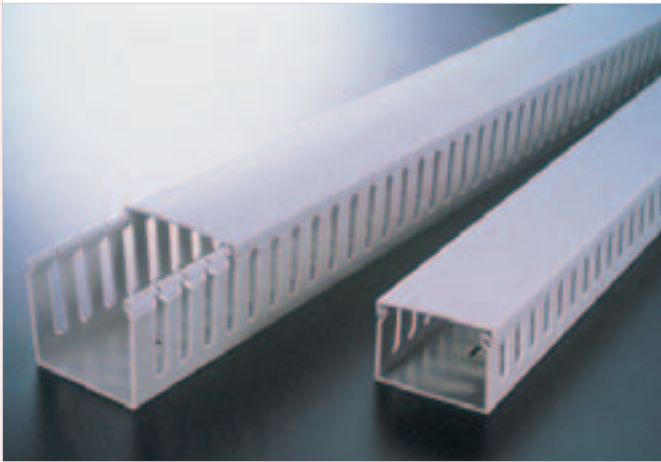

Color: ■ Gris.

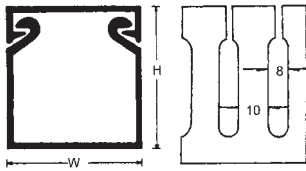

VD Agujero: 8 mm.

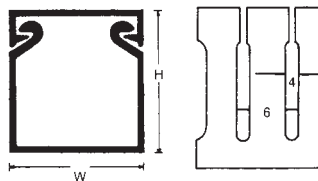

HVD Agujero : 4 mm.

| Ref. 8mm. | Ref. 6mm. | Ref. 4mm. | Dimensiones W x H mm. | Para número de cables | Largo |
|----------------|--------------|-----------------|--------------------------|--------------------------|-------|
| VD-1 | | HVD-1 | 25x30 | 15-25 uds. | 2 m |
| VD-1.5 | | HVD-1.5 | 30x30 | 15-25 uds. | 2 m |
| VD-2 | | HVD-2 | 25x40 | 20-25 uds. | 2 m |
| VD-3 | | HVD-3 | 33x40 | 40-45 uds. | 2 m |
| VD-4 | KVD-4 | HVD-4 | 40x40 | 60-70 uds. | 2 m |
| VD-5 | | HVD-5 | 60x40 | 100-115 uds. | 2 m |
| VD-5.5 | | HVD-5.5 | 80x40 | 120-135 uds. | 2 m |
| VD-5.7 | | HVD-5.7 | 100x40 | 130-175 uds. | 2 m |
| VD-6 | | HVD-6 | 25x60 | 40-45 uds. | 2 m |
| VD-7 | KVD-7 | HVD-7 | 40x60 | 100-115 uds. | 2 m |
| VD-8 | KVD-8 | HVD-8 | 60x60 | 120-135 uds. | 2 m |
| VD-9 | | HVD-9 | 80x60 | 180-210 uds. | 2 m |
| VD-9.5 | | HVD-9.5 | 100x60 | 240-290 uds. | 2 m |
| VD-9.6 | | HVD-9.6 | 120x60 | 240-290 uds. | 2 m |
| VD-9.65 | | HVD-9.65 | 120x65 | 260-360 uds. | 2 m |
| VD-9.66 | | HVD-9.66 | 25x80 | 100-120 uds. | 2 m |
| VD-9.7 | | HVD-9.7 | 40x80 | 120-135 uds. | 2 m |
| VD-9.8 | | HVD-9.8 | 60x80 | 180-210 uds. | 2 m |
| VD-10 | | HVD-10 | 80x80 | 240-290 uds. | 2 m |
| VD-10.5 | | HVD-10.5 | 100x80 | 260-350 uds. | 2 m |
| VD-11 | | HVD-11 | 120x80 | 300-400 uds. | 2 m |
| VD-12 | | HVD-12 | 40x100 | 130-175 uds. | 2 m |
| VD-13 | | HVD-13 | 60x100 | 240-290 uds. | 2 m |
| VD-14 | | HVD-14 | 80x100 | 260-350 uds. | 2 m |

Canaleta (agujero cerrado)



E 97527



LR 82854

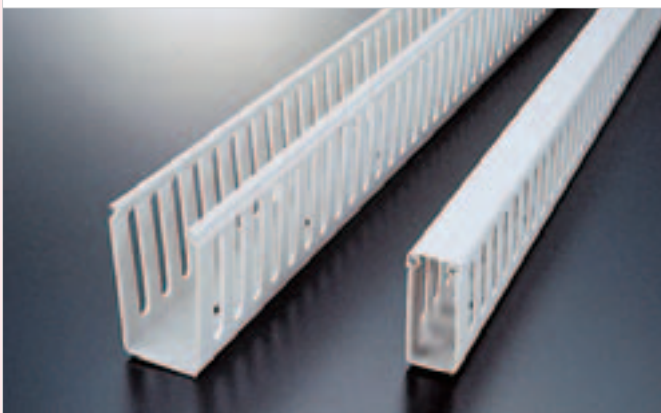

El diseño del agujero cerrado facilita la instalación y desinstalación de la tapa. Corte opcional donde la inserción o extensión sea necesaria.

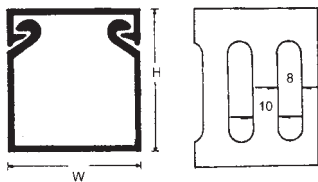

VDC Agujero: 8 mm.

| Ref. Agujero 8mm. | Dimensiones W x H mm. | Para número de cables | Largo |
|----------------------|--------------------------|--------------------------|-------|
| VDC-2530 | 25x30 | 15-25 uds. | 2 m |
| VDC-2560 | 25x60 | 40-45 uds. | 2 m |
| VDC-4040 | 40x40 | 60-70 uds. | 2 m |
| VDC-4060 | 40x60 | 100-115 uds. | 2 m |
| VDC-4080 | 40x80 | 120-135 uds. | 2 m |
| VDC-5050 | 50x50 | 80-90 uds. | 2 m |
| VDC-6060 | 60x60 | 120-135 uds. | 2 m |
| VDC-6080 | 60x80 | 180-210 uds. | 2 m |
| VDC-8080 | 80x80 | 240-290 uds. | 2 m |
| VDC-100100 | 100x100 | 300-400 uds. | 2 m |



Canaleta (agujero abierto)

E 97527 LR 82854

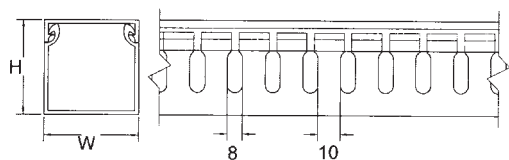
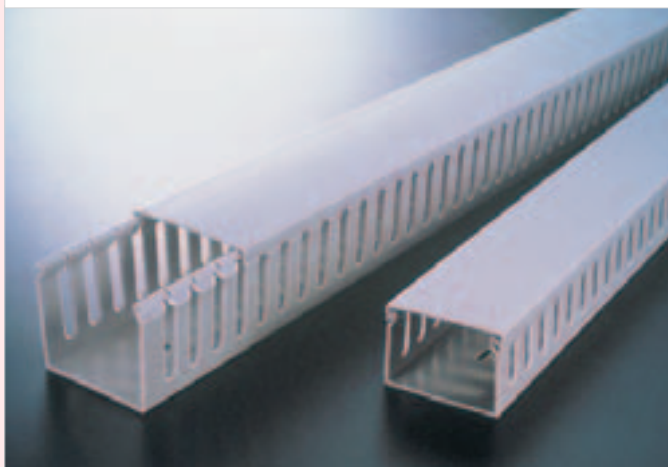

Material: Resistente a grandes impactos, autoextinguible, en PVC antideformable.

Color: ■ Gris.

Temperatura máxima: 85° C.

Con ranuras paralelas en los dos lados para facilitar el corte.

Canaleta (agujero abierto)

E 97527 LR 82854

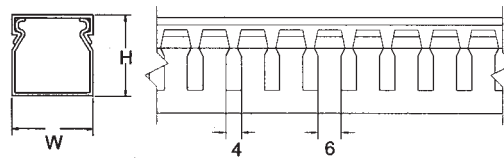

Material: Resistente a grandes impactos, autextinguible en PVC antideformable.

Color: ■ Gris.

Temperatura máxima: 85° C.

Con ranuras paralelas en los dos lados para facilitar el corte.

| Ref. Agujero 8mm. | Ref. Sin agujero | Dimensiones W x H mm. | Para número de cables | Largo |
|----------------------|---------------------|--------------------------|--------------------------|-------|
| AD-1x2 | SD-1x2 | 25x50 | 20-25 uds. | 2 m |
| AD-1x3 | SD-1x3 | 25x75 | 60-75 uds. | 2 m |
| AD-1.5x1 | SD-1.5x1 | 38x25 | 20-23 uds. | 2 m |
| AD-1.5x2 | SD-1.5x2 | 38x50 | 60-70 uds. | 2 m |
| AD-2x2 | SD-2x2 | 50x50 | 80-90 uds. | 2 m |
| AD-2x3 | SD-2x3 | 50x75 | 180-200 uds. | 2 m |
| AD-3x2 | SD-3x2 | 75x50 | 180-200 uds. | 2 m |
| AD-3x3 | SD-3x3 | 75x75 | 200-250 uds. | 2 m |
| AD-3x4 | SD-3x4 | 75x100 | 240-300 uds. | 2 m |

| Ref. Agujero 4mm. | Dimensiones W x H mm. | Para número de cables | Largo |
|----------------------|--------------------------|--------------------------|-------|
| BD-2525 | 25x25 | 10-25 uds. | 2 m |
| BD-3340 | 33x40 | 40-45 uds. | 2 m |
| BD-4040 | 40x40 | 50-60 uds. | 2 m |
| BD-3360 | 33x60 | 60-70 uds. | 2 m |
| BD-4860 | 48x60 | 110-120 uds. | 2 m |
| BD-6060 | 60x60 | 120-135 uds. | 2 m |



Canaleta flexible

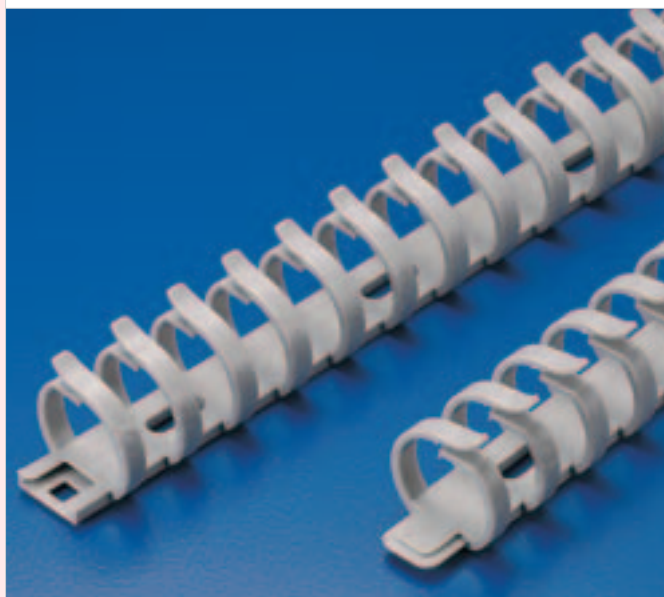

Material: NYLON 66. Color: ■ Gris.

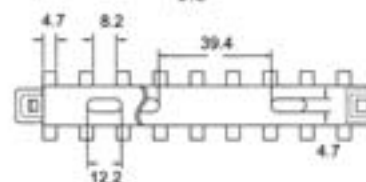
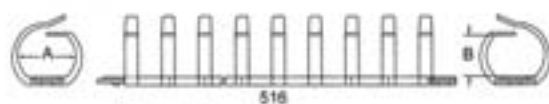

FD-20

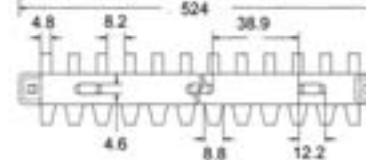

FD-30

| Ref. | A | B | Dimensiones W x H mm. | Para número de cables | Largo |
|--------------|------|------|--------------------------|--------------------------|-------|
| FD-20 | 20.4 | 14.4 | 20 x 14 | 5-12 uds. | 50 cm |
| FD-30 | 29 | 24.9 | 31 x 33 | 12-30 uds. | 50 cm |

“Mini trunking”



Material: PVC. Color: □ Blanco.

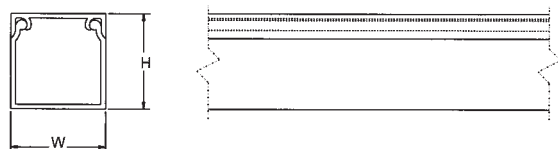

| Ref. | Dimensiones W x H mm. | Para número de cables | Largo |
|----------------|--------------------------|--------------------------|-------|
| UD-1809 | 18x9 | 2-6 uds. | 2 m |
| UD-1616 | 16x16 | 3-10 uds. | 2 m |
| UD-2516 | 25x16 | 5-12 uds. | 2 m |
| UD-4016 | 40x16 | 20-35 uds. | 2 m |
| UD-4025 | 40x25 | 20-40 uds. | 2 m |
| UD-5025 | 50x25 | 25-45 uds. | 2 m |



Canaleta sólida E 97527 LR 82854

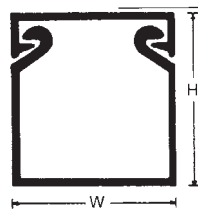







Material: PVC resistente a grandes impactos, autoextinguible y antideformable. Color: ■ Gris. Temperatura máxima: 85° C.
Diseñada sin agujeros para usos externos o instalaciones que no requieran extracciones. Válido para todas las aplicaciones donde la protección del cable sea esencial como en paneles de control. Para colores, largos y medidas especiales, consultar cantidades mínimas.

| Ref. | Dimensiones W x H mm. | Para número de cables | Largo | Ref. | Dimensiones W x H mm. | Para número de cables | Largo |
|-----------------|-----------------------|-----------------------|-------|------------------|-----------------------|-----------------------|-------|
| SD-2210 | 22x10 | 3-8 uds. | 2 m | SD-8050 | 80x50 | 180-200 uds. | 2 m |
| SD-3015 | 30x15 | 10-25 uds. | 2 m | SD-10050 | 100x50 | 200-250 uds. | 2 m |
| SD-1616 | 16x16 | 3-10 uds. | 2 m | SD-2560 | 25x60 | 40-45 uds. | 2 m |
| SD-2516 | 25x16 | 5-12 uds. | 2 m | SD-4060 | 40x60 | 100-115 uds. | 2 m |
| SD-3816 | 38x16 | 12-30 uds. | 2 m | SD-6060 | 60x60 | 120-135 uds. | 2 m |
| SD-2020 | 20x20 | 5-12 uds. | 2 m | SD-8060 | 80x60 | 180-210 uds. | 2 m |
| SD-4020 | 40x20 | 20-40 uds. | 2 m | SD-10060 | 100x60 | 240-290 uds. | 2 m |
| SD-1525 | 15x25 | 5-12 uds. | 2 m | SD-12060 | 120x60 | 240-290 uds. | 2 m |
| SD-2525 | 25x25 | 10-25 uds. | 2 m | SD-7264 | 72x64 | 200-220 uds. | 2 m |
| SD-3825 | 38x25 | 20-40 uds. | 2 m | SD-2565 | 25x65 | 40-45 uds. | 2 m |
| SD-5025 | 50x25 | 25-45 uds. | 2 m | SD-3365 | 33x65 | 60-75 uds. | 2 m |
| SD-2530 | 25x30 | 15-25 uds. | 2 m | SD-4565 | 45x65 | 110-120 uds. | 2 m |
| SD-3030 | 30x30 | 20-40 uds. | 2 m | SD-6565 | 65x65 | 180-200 uds. | 2 m |
| SD-3333 | 33x33 | 25-45 uds. | 2 m | SD-12065 | 120x65 | 260-350 uds. | 2 m |
| SD-10030 | 100x30 | 130-160 uds. | 2 m | SD-2575 | 25x75 | 50-55 uds. | 2 m |
| SD-10033 | 100x33 | 180-200 uds. | 2 m | SD-5075 | 50x75 | 180-200 uds. | 2 m |
| SD-3838 | 38x38 | 45-50 uds. | 2 m | SD-7575 | 75x75 | 200-250 uds. | 2 m |
| SD-2540 | 25x40 | 20-25 uds. | 2 m | SD-10075 | 100x75 | 260-320 uds. | 2 m |
| SD-3340 | 33x40 | 40-45 uds. | 2 m | SD-12075 | 120x75 | 280-380 uds. | 2 m |
| SD-4040 | 40x40 | 60-70 uds. | 2 m | SD-15075 | 150x75 | 335-500 uds. | 2 m |
| SD-6040 | 60x40 | 100-115 uds. | 2 m | SD-2580 | 25x80 | 60-75 uds. | 2 m |
| SD-7540 | 75x40 | 120-135 uds. | 2 m | SD-4080 | 40x80 | 120-135 uds. | 2 m |
| SD-8040 | 80x40 | 120-135 uds. | 2 m | SD-6080 | 60x80 | 180-210 uds. | 2 m |
| SD-10040 | 100x40 | 180-200 uds. | 2 m | SD-8080 | 80x80 | 240-290 uds. | 2 m |
| SD-2545 | 25x45 | 20-25 uds. | 2 m | SD-10080 | 100x80 | 260-350 uds. | 2 m |
| SD-3345 | 33x45 | 40-55 uds. | 2 m | SD-12080 | 120x80 | 300-400 uds. | 2 m |
| SD-4545 | 45x45 | 60-70 uds. | 2 m | SD-33100 | 33x100 | 180-200 uds. | 2 m |
| SD-6545 | 65x45 | 110-120 uds. | 2 m | SD-375100 | 37.5x100 | 180-200 uds. | 2 m |
| SD-2550 | 25x50 | 20-30 uds. | 2 m | SD-40100 | 40x100 | 130-175 uds. | 2 m |
| SD-3850 | 38x50 | 20-35 uds. | 2 m | SD-48100 | 48x100 | 215-250 uds. | 2 m |
| SD-5050 | 50x50 | 80-90 uds. | 2 m | SD-50100 | 50x100 | 210-260 uds. | 2 m |
| SD-7550 | 75x50 | 180-200 uds. | 2 m | SD-55100 | 55x100 | 220-260 uds. | 2 m |

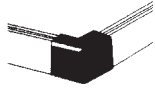

| Ref. | Dimensiones W x H mm. | Para número de cables | Largo |
|------------------|--------------------------|--------------------------|-------|
| SD-60100 | 60x100 | 240-290 uds. | 2 m |
| SD-70100 | 70x100 | 250-300 uds. | 2 m |
| SD-75100 | 75x100 | 260-300 uds. | 2 m |
| SD-80100 | 80x100 | 260-350 uds. | 2 m |
| SD-100100 | 100x100 | 300-400 uds. | 2 m |
| SD-150100 | 150x100 | 450-600 uds. | 2 m |
| SD-200100 | 200x100 | 600-800 uds. | 2 m |
| SD-200150 | 200x150 | 1040-1200 uds. | 2 m |
| SD-200200 | 200x200 | 1200-1600 uds. | 2 m |
| SD-300100 | 300x100 | 1040-1400 uds. | 2 m |

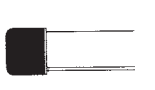
| Conector | Tipo | Ref. | Para usar con |  |
|---|--------------------|-----------------|------------------|---|
|  | plano | SDM-1616 | SD-1616 | 20 |
| | | SDM-2516 | SD-2516 | 20 |
| | | SDM-3816 | SD-3816 | 20 |
| | | SDM-4040 | SD-4040 | 20 |
| | | SDM-5050 | SD-5050 | 20 |
| | | SDM-7575 | SD-7575 | 20 |
|  | ángulo exterior | SDO-1616 | SD-1616 | 20 |
| | | SDO-2516 | SD-2516 | 20 |
| | | SDO-3816 | SD-3816 | 20 |
| | | SDO-4040 | SD-4040 | 20 |
| | | SDO-5050 | SD-5050 | 20 |
| | | SDO-7575 | SD-7575 | 20 |
|  | tipo "T" | SDT-1616 | SD-1616 | 20 |
| | | SDT-2516 | SD-2516 | 20 |
| | | SDT-3816 | SD-3816 | 20 |
| | | SDT-4040 | SD-4040 | 20 |
| | | SDT-5050 | SD-5050 | 20 |
| | | SDT-7575 | SD-7575 | 20 |
|  | tipo "L" | SDL-1616 | SD-1616 | 20 |
| | | SDL-2516 | SD-2516 | 20 |
| | | SDL-3816 | SD-3816 | 20 |
| | | SDL-4040 | SD-4040 | 20 |
| | | SDL-5050 | SD-5050 | 20 |
| | | SDL-7575 | SD-7575 | 20 |
|  | ángulo interior | SDI-1616 | SD-1616 | 20 |
| | | SDI-2516 | SD-2516 | 20 |
| | | SDI-3816 | SD-3816 | 20 |
| | | SDI-4040 | SD-4040 | 20 |
| | | SDI-5050 | SD-5050 | 20 |
| | | SDI-7575 | SD-7575 | 20 |
|  | pieza final | SDE-1616 | SD-1616 | 20 |
| | | SDE-2516 | SD-2516 | 20 |
| | | SDE-3816 | SD-3816 | 20 |
| | | SDE-4040 | SD-4040 | 20 |
| | | SDE-5050 | SD-5050 | 20 |
| | | SDE-7575 | SD-7575 | 20 |

Sujetador de cables

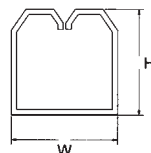
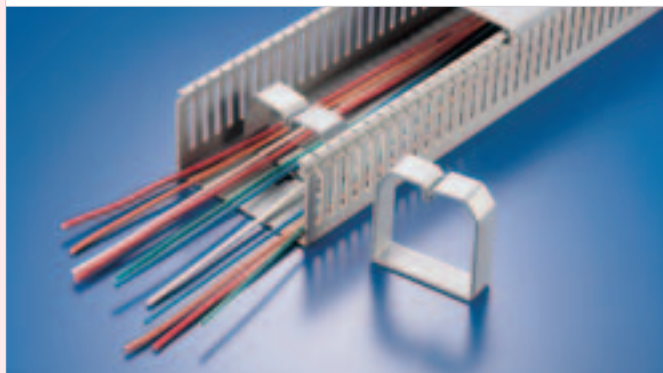

Material: ABS
Color: ■ Gris.

| Ref. | Dimensiones W x H mm. |  |
|----------------|--------------------------|---|
| LS-2040 | 20x40 | 100 |
| LS-4040 | 40x40 | 100 |
| LS-7040 | 70x40 | 100 |
| LS-2065 | 20x65 | 100 |
| LS-4065 | 40x65 | 100 |
| LS-6565 | 65x65 | 100 |

Remache

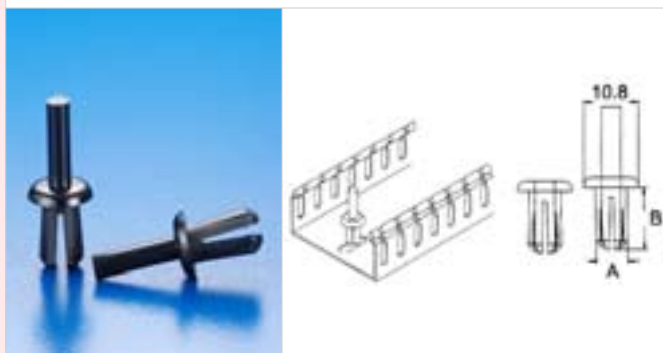

Material: Nylon 66.

| Ref. | Dimensiones mm. | | |  |
|-----------------|-----------------|------|----------|---|
| | A | B | C | |
| SR-0612K | 6.2 | 12.3 | 7.0-10.0 | 1000 |



Cortadora de canaletas

Ref. **WT-1**



Cortadora de canaletas

Ref. **WT-2**

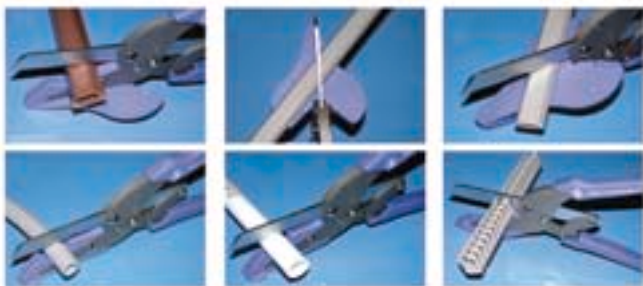

Canaleta

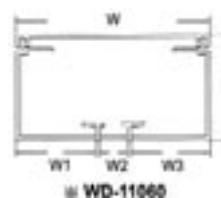
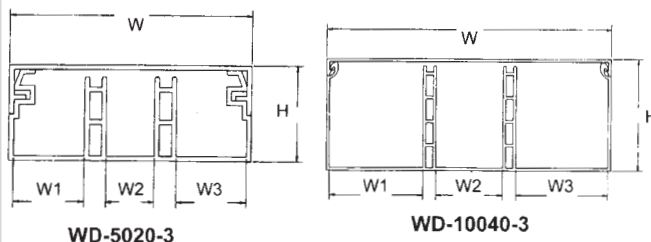
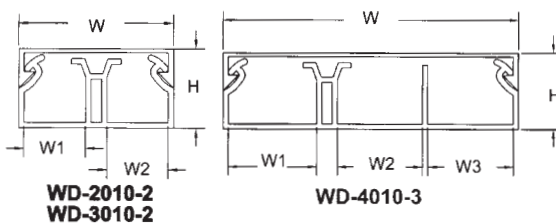

Material: PVC resistente a grandes impactos, autoextinguible, antideformable.

Color: Blanco. Temperatura máxima: 85° C.

Diseñado con ranuras paralelas en los dos lados para facilitar el corte durante la aplicación.

| Ref. | Dimensiones mm. | | | | | Largo |
|-------------------|-----------------|------|------|------|------|-------|
| | W | W1 | W2 | W3 | H | |
| WD-2010-2 | 20.0 | 7.5 | 7.5 | - | 10.3 | 2 m |
| WD-3010-2 | 30.0 | 12.5 | 12.5 | - | 11.2 | 2 m |
| WD-4010-3 | 40.0 | 11.0 | 11.5 | 11.5 | 10.3 | 2 m |
| WD-5020-3 | 50.8 | 14.8 | 10.0 | 14.8 | 20.3 | 2 m |
| WD-10040-3 | 100.0 | 32.8 | 23.2 | 32.8 | 40.0 | 2 m |
| WD-11060 | 111.0 | 43.3 | 16.0 | 43.3 | 61.4 | 2 m |

Uniones para canaletas decorativas "WD"



Material: ABS. Color: Blanco.

| Conector | Tipo | Ref. | Para usar con | |
|----------|-----------------|-----------------|---------------|----|
| | plano | WDM-2010 | WD-2010-2 | 20 |
| | | WDM-3010 | WD-3010-2 | 20 |
| | | WDM-4010 | WD-4010-3 | 20 |
| | | WDM-5020 | WD-5020-3 | 20 |
| | tipo "T" | WDT-2010 | WD-2010-2 | 20 |
| | | WDT-3010 | WD-3010-2 | 20 |
| | | WDT-4010 | WD-4010-3 | 20 |
| | | WDT-5020 | WD-5020-3 | 20 |
| | ángulo interior | WDI-2010 | WD-2010-2 | 20 |
| | | WDI-3010 | WD-3010-2 | 20 |
| | | WDI-4010 | WD-4010-3 | 20 |
| | | WDI-5020 | WD-5020-3 | 20 |
| | ángulo exterior | WDO-2010 | WD-2010-2 | 20 |
| | | WDO-3010 | WD-3010-2 | 20 |
| | | WDO-4010 | WD-4010-3 | 20 |
| | | WDO-5020 | WD-5020-3 | 20 |
| | tipo "L" | WDL-2010 | WD-2010-2 | 20 |
| | | WDL-3010 | WD-3010-2 | 20 |
| | | WDL-4010 | WD-4010-3 | 20 |
| | | WDL-5020 | WD-5020-3 | 20 |
| | pieza final | WDE-2010 | WD-2010-2 | 20 |
| | | WDE-3010 | WD-3010-2 | 20 |
| | | WDE-4010 | WD-4010-3 | 20 |
| | | WDE-5020 | WD-5020-3 | 20 |

Canaletas para decoración E 97527

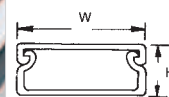
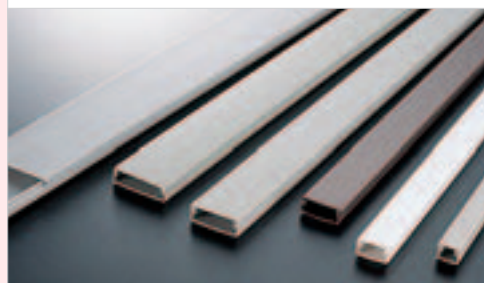

Material: PVC rígido y autoextinguible Color standard: Gris.

Colores bajo demanda: Blanco, marfil, marrón. Todas las medidas tienen el mismo alto de 11 mm. Diseñado especialmente para cables planos.

Aplicaciones: Internas de cables, o instalaciones de alarmas exteriores.

| Ref. | Dimensiones mm. | | Para número de cables | Largo |
|----------------|-----------------|----|-----------------------|-------|
| | W | H | | |
| TF-1 | 12.7 | 11 | 1-4 | 2 m |
| TF-2 | 19.0 | 11 | 2-6 | 2 m |
| TF-3 | 25.4 | 11 | 5-9 | 2 m |
| TF-4 | 31.8 | 11 | 6-12 | 2 m |
| TF-5 | 38.1 | 11 | 10-18 | 2 m |
| TF-6 | 50.8 | 11 | 15-25 | 2 m |
| TF-11 | 12.7 | 11 | 1-4 | 1 m |
| TF-11BN | 12.7 | 11 | 1-4 | 1 m |
| TF-11DB | 12.7 | 11 | 1-4 | 1 m |
| TF-11WE | 12.7 | 11 | 1-4 | 1 m |
| TF-11MW | 12.7 | 11 | 1-4 | 1 m |
| TF-11LX | 12.7 | 11 | 1-4 | 1 m |
| TF-11DX | 12.7 | 11 | 1-4 | 1 m |
| TF-21 | 19.0 | 11 | 2-6 | 1 m |
| TF-21BN | 19.0 | 11 | 2-6 | 1 m |
| TF-21DB | 19.0 | 11 | 2-6 | 1 m |
| TF-21WE | 19.0 | 11 | 2-6 | 1 m |
| TF-21MW | 19.0 | 11 | 2-6 | 1 m |
| TF-21LX | 19.0 | 11 | 2-6 | 1 m |
| TF-21DX | 19.0 | 11 | 2-6 | 1 m |
| TF-31 | 25.4 | 11 | 5-9 | 1 m |
| TF-31BN | 25.4 | 11 | 5-9 | 1 m |
| TF-31DB | 25.4 | 11 | 5-9 | 1 m |
| TF-31WE | 25.4 | 11 | 5-9 | 1 m |
| TF-31MW | 25.4 | 11 | 5-9 | 1 m |
| TF-31FX | 25.4 | 11 | 5-9 | 1 m |
| TF-31DX | 25.4 | 11 | 5-9 | 1 m |
| TF-41 | 31.8 | 11 | 6-12 | 1 m |
| TF-51 | 38.1 | 11 | 10-18 | 1 m |
| TF-61 | 50.8 | 11 | 15-25 | 1 m |



Uniones para canaletas decorativas "TF"



Material: ABS. Color standard: ■ Gris.

Colores bajo demanda: □ Blanco, ■ marfil, ■ marrón.

| Conector | Tipo | Ref. | Para usar con | |
|----------|-----------------|--------------|---------------|----|
| | plano | TFM-1 | TF-1 | 20 |
| | | TFM-2 | TF-2 | 20 |
| | | TFM-3 | TF-3 | 20 |
| | | TFM-4 | TF-4 | 20 |
| | tipo "T" | TFT-1 | TF-1 | 20 |
| | | TFT-2 | TF-2 | 20 |
| | | TFT-3 | TF-3 | 20 |
| | | TFT-4 | TF-4 | 20 |
| | ángulo interior | TFI-1 | TF-1 | 20 |
| | | TFI-2 | TF-2 | 20 |
| | | TFI-3 | TF-3 | 20 |
| | | TFI-4 | TF-4 | 20 |
| | ángulo exterior | TFO-1 | TF-1 | 20 |
| | | TFO-2 | TF-2 | 20 |
| | | TFO-3 | TF-3 | 20 |
| | | TFO-4 | TF-4 | 20 |
| | tipo "L" | TFL-1 | TF-1 | 20 |
| | | TFL-2 | TF-2 | 20 |
| | | TFL-3 | TF-3 | 20 |
| | | TFL-4 | TF-4 | 20 |
| | pieza final | TFE-1 | TF-1 | 20 |
| | | TFE-2 | TF-2 | 20 |
| | | TFE-3 | TF-3 | 20 |
| | | TFE-4 | TF-4 | 20 |

Uniones para canaletas decorativas "TC"



Material: ABS. Color standard: ■ Gris.

Colores bajo demanda: □ Blanco, ■ marfil, ■ marrón.

| Conector y tipo | Ref. | Para usar con | | Ref. | Para usar con | |
|-----------------|--------------|---------------|----|--------------|---------------|----|
| | TCM-1 | TC-1 | 20 | TCM-4 | TC-4 | 20 |
| | TCM-2 | TC-2 | 20 | TCM-5 | TC-5 | 20 |
| | TCM-3 | TC-3 | 20 | TCM-6 | TC-6 | 20 |
| | TCT-1 | TC-1 | 20 | TCT-4 | TC-4 | 20 |
| | TCT-2 | TC-1 | 20 | TCT-5 | TC-5 | 20 |
| | TCT-3 | TC-3 | 20 | TCT-6 | TC-6 | 20 |
| | TCI-1 | TC-1 | 20 | TCI-4 | TC-4 | 20 |
| | TCI-2 | TC-2 | 20 | TCI-5 | TC-5 | 20 |
| | TCI-3 | TC-3 | 20 | TCI-6 | TC-6 | 20 |
| | TCO-1 | TC-1 | 20 | TCO-4 | TC-4 | 20 |
| | TCO-2 | TC-2 | 20 | TCO-5 | TC-5 | 20 |
| | TCO-3 | TC-3 | 20 | TCO-6 | TC-6 | 20 |
| | TCL-1 | TC-1 | 20 | TCL-4 | TC-4 | 20 |
| | TCL-2 | TC-2 | 20 | TCL-5 | TC-5 | 20 |
| | TCL-3 | TC-3 | 20 | TCL-6 | TC-6 | 20 |
| | TCE-1 | TC-1 | 20 | TCE-4 | TC-4 | 20 |
| | TCE-2 | TC-2 | 20 | TCE-5 | TC-5 | 20 |
| | TCE-3 | TC-3 | 20 | TCE-6 | TC-6 | 20 |

Canaleta para teléfono (auto-adhesiva) E 97527

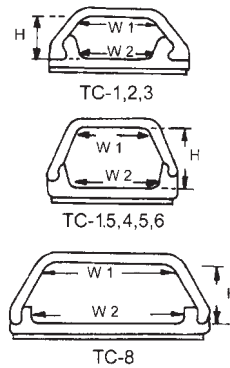
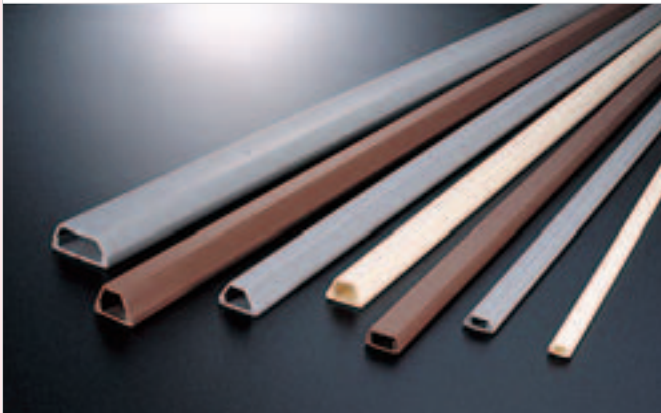

Material: PVC rígido, autoextinguible con cinta auto adhesiva de alta calidad en la base.

Color standard: ■ Gris.

Colores bajo demanda: □ Blanco, ■ marfil, ■ marrón.

Largo: 1 m. Bajo demanda: 2 m.

Aplicación: Protección de los cables del suelo.

| Ref. | Dimensiones mm. | | | Para nº cables | Largo | Ref. | Dimensiones mm. | | | Para nº cables | Largo | Ref. | Dimensiones mm. | | | Para nº cables | Largo |
|-----------------|-----------------|----|-----|----------------|-------|---------------|-----------------|----|----|----------------|-------|---------------|-----------------|----|----|----------------|-------|
| | W1 | W2 | H1 | | | | W1 | W2 | H1 | | | | W1 | W2 | H1 | | |
| TC-1 | 6 | 7 | 4 | 1 | 1 m | TC-2DX | 8 | 8 | 6 | 2-3 | 1 m | TC-5WE | 10 | 17 | 13 | 7-9 | 1 m |
| TC-1BN | 6 | 7 | 4 | 1 | 1 m | TC-3 | 10 | 10 | 7 | 3-4 | 1 m | TC-5MW | 10 | 17 | 13 | 7-9 | 1 m |
| TC-1DB | 6 | 7 | 4 | 1 | 1 m | TC-3BN | 10 | 10 | 7 | 3-4 | 1 m | TC-5LX | 10 | 17 | 13 | 7-9 | 1 m |
| TC-1WE | 6 | 7 | 4 | 1 | 1 m | TC-3DB | 10 | 10 | 7 | 3-4 | 1 m | TC-5DX | 10 | 17 | 13 | 7-9 | 1 m |
| TC-1MW | 6 | 7 | 4 | 1 | 1 m | TC-3WE | 10 | 10 | 7 | 3-4 | 1 m | TC-6 | 11 | 19 | 16 | 10-15 | 1 m |
| TC-1LX | 6 | 7 | 4 | 1 | 1 m | TC-3MW | 10 | 10 | 7 | 3-4 | 1 m | TC-6BN | 11 | 19 | 16 | 10-15 | 1 m |
| TC-1DX | 6 | 7 | 4 | 1 | 1 m | TC-3LX | 10 | 10 | 7 | 3-4 | 1 m | TC-6DB | 11 | 19 | 16 | 10-15 | 1 m |
| TC-1.5 | 6 | 8 | 7.4 | 1-2 | 1 m | TC-3DX | 10 | 10 | 7 | 3-4 | 1 m | TC-6WE | 11 | 19 | 16 | 10-15 | 1 m |
| TC-1.5BN | 6 | 8 | 7.4 | 1-2 | 1 m | TC-4 | 12 | 15 | 10 | 4-7 | 1 m | TC-6MW | 11 | 19 | 16 | 10-15 | 1 m |
| TC-1.5MW | 6 | 8 | 7.4 | 1-2 | 1 m | TC-4BN | 12 | 15 | 10 | 4-7 | 1 m | TC-6LX | 11 | 19 | 16 | 10-15 | 1 m |
| TC-1.5LX | 6 | 8 | 7.4 | 1-2 | 1 m | TC-4DB | 12 | 15 | 10 | 4-7 | 1 m | TC-6DX | 11 | 19 | 16 | 10-15 | 1 m |
| TC-1.5DX | 6 | 8 | 7.4 | 1-2 | 1 m | TC-4WE | 12 | 15 | 10 | 4-7 | 1 m | TC-8 | 30 | 37 | 16 | 30-40 | 1 m |
| TC-2 | 8 | 8 | 6 | 2-3 | 1 m | TC-4MW | 12 | 15 | 10 | 4-7 | 1 m | TC-8BN | 30 | 37 | 16 | 30-40 | 1 m |
| TC-2BN | 8 | 8 | 6 | 2-3 | 1 m | TC-4LX | 12 | 15 | 10 | 4-7 | 1 m | TC-8MW | 30 | 37 | 16 | 30-40 | 1 m |
| TC-2DB | 8 | 8 | 6 | 2-3 | 1 m | TC-4DX | 12 | 15 | 10 | 4-7 | 1 m | TC-8LX | 30 | 37 | 16 | 30-40 | 1 m |
| TC-2WE | 8 | 8 | 6 | 2-3 | 1 m | TC-5 | 10 | 17 | 13 | 7-9 | 1 m | TC-8DX | 30 | 37 | 16 | 30-40 | 1 m |
| TC-2MW | 8 | 8 | 6 | 2-3 | 1 m | TC-5BN | 10 | 17 | 13 | 7-9 | 1 m | | | | | | |
| TC-2LX | 8 | 8 | 6 | 2-3 | 1 m | TC-5DB | 10 | 17 | 13 | 7-9 | 1 m | | | | | | |



Canaleta para teléfono (auto-adhesiva)

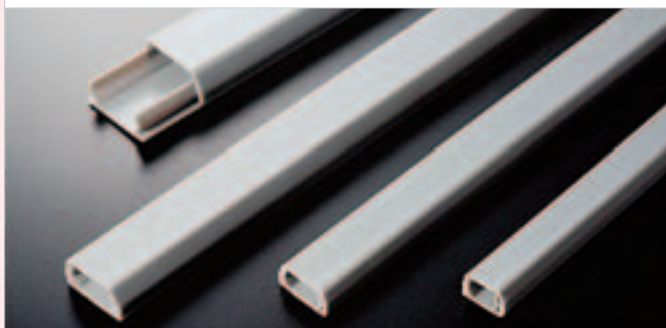

Conectores:
 Plano **JDM-1**
 Ángulo exterior **JDO-1**
 Tipo "T" **JDT-1**
 Tipo "L" **JDL-1**
 Ángulo interior **JDI-1**

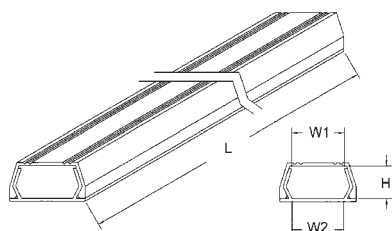

Material: PVC rígido, autoextinguible con cinta auto adhesiva de alta calidad en la base.

Color standard: ■ Gris.

Colores bajo demanda: □ Blanco, ■ marfil, ■ marrón.

Largo: 1 m. Bajo demanda: 2 m.

Aplicación: Protección de los cables del suelo.

| Ref. | Dimensiones mm. | | | Largo | Conector |
|---------------|-----------------|------|------|-------|----------------------|
| | W1 | W2 | H | | |
| JD-1 | 10.4 | 8.6 | 8.0 | 1 m | JDT-1 / JDM-1 |
| JD-1BN | 10.4 | 8.6 | 8.0 | 1 m | JDI-1 / JDO-1 |
| JD-1MW | 10.4 | 8.6 | 8.0 | 1 m | JDL-1 / JDE-1 |
| JD-2 | 14.5 | 11.5 | 8.0 | 1 m | JDT-2 / JDM-2 |
| JD-2BN | 14.5 | 11.5 | 8.0 | 1 m | JDI-2 / JDO-2 |
| JD-2MW | 14.5 | 11.5 | 8.0 | 1 m | JDL-2 / JDE-2 |
| JD-3 | 18.8 | 16.4 | 10.8 | 1 m | JDT-3 / JDM-3 |
| JD-3BN | 18.8 | 16.4 | 10.8 | 1 m | JDI-3 / JDO-3 |
| JD-3MW | 18.8 | 16.4 | 10.8 | 1 m | JDL-3 / JDE-3 |
| JD-4 | 23.5 | 19.5 | 12.2 | 1 m | JDT-4 / JDM-4 |
| JD-4BN | 23.5 | 19.5 | 12.2 | 1 m | JDI-4 / JDO-4 |
| JD-4MW | 23.5 | 19.5 | 12.2 | 1 m | JDL-4 / JDE-4 |

Canaletas de una sola pieza

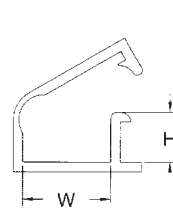
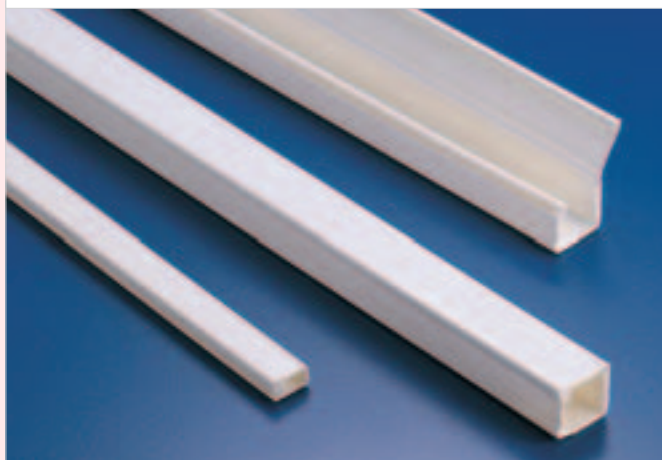

TF-0905

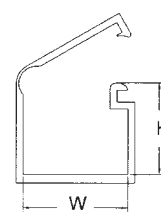

TF-1313

Material: PVC rígido autoextinguible. Temperatura máxima de uso: 85°C.
 Diseñado de una sola pieza, combina la base de la canaleta con la boca.
 De fácil aplicación que permite un ahorro de tiempo.

| Ref. | Dimensiones mm. | | Largo |
|----------------|-----------------|------|-------|
| | W | H | |
| TF-0905 | 9.2 | 2.9 | 2 m |
| TF-1313 | 13.2 | 10.8 | 2 m |



Canaleta tipo "U"

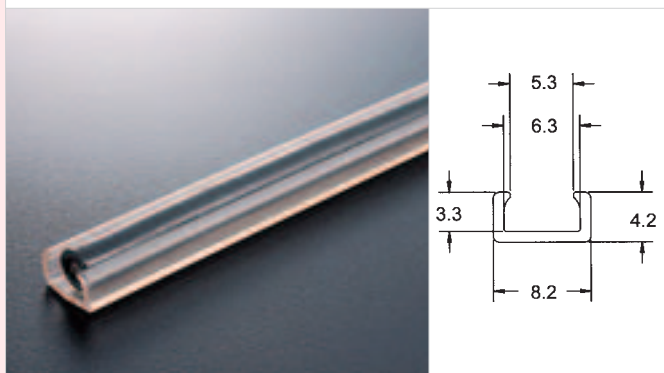

Material: PVC. Color: Transparente.

Aplicaciones: Arrancar la cinta adhesiva y limpiar la grasa de las superficies. Introducir el cable mediante presión con los dedos.

| Ref. | Largo | Para cable |
|-------------|-------|------------|
| TD-1 | 2 m | 6.5 |

Tubos ovaes para canalización

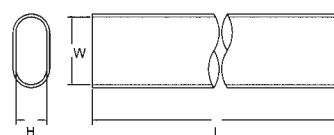

Material: PVC. Color: Blanco.

| Ref. | Dimensiones mm. | | |
|--------------|-----------------|------|-----|
| | W | H | L |
| OV-13 | 11.0 | 5.9 | 2 m |
| OV-16 | 14.9 | 7.9 | 2 m |
| OV-20 | 20.6 | 9.8 | 2 m |
| OV-25 | 25.2 | 11.8 | 2 m |

Tubos para canalización

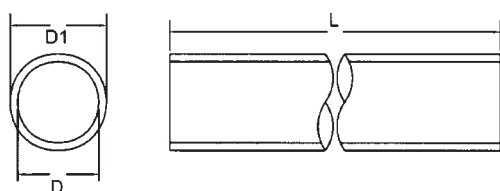

Material: PVC. Color: Blanco.

| Ref. | Dimensiones mm. | | |
|--------------|-----------------|------|-----|
| | D | D1 | L |
| OD-20 | 16.2 | 20.0 | 2 m |
| OD-25 | 21.0 | 25.0 | 2 m |

Canaleta

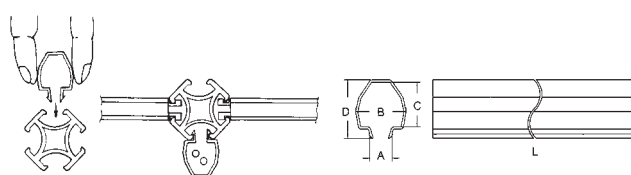

Material: PVC. Color: Gris.

| Ref. | Dimensiones mm. | | | | |
|-------------|-----------------|------|------|------|-----|
| | A | B | C | D | L |
| EX-1 | 10.9 | 24.8 | 21.6 | 28.2 | 2 m |



Canaletas de tipo redondo

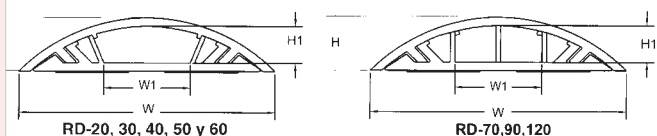
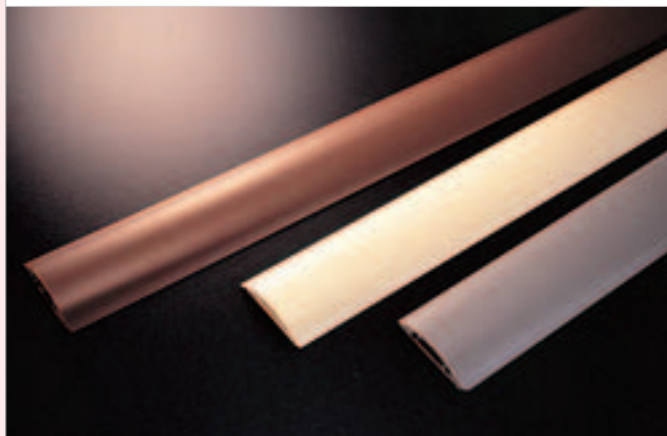

Material: PVC rígido, autoextinguible y resistente a grandes impactos.
 Temperatura máxima de uso: 85° C. Color standard: ■ Gris. Colores bajo demanda: □ Blanco, ■ marfil, ■ marrón. Acabada con adhesivo de doble cara de alta calidad en la base para un pegado permanente, recomendable para instalar en suelos donde deban pasar ruedas.



| | |
|-------------------------------------|-------------------------------------|
| Cubierta conector: | Base conector: |
| Plano RDM-20 | Plano RBM-260 |
| Ángulo exterior..... RDO-20 | Ángulo exterior..... RBO-60 |
| Tipo "T"..... RD-20 | Tipo "T"..... RBT-60 |
| Tipo "L"..... RDL-20 | Tipo "L"..... RBL-60 |
| Ángulo interior RDI-20 | Ángulo interior RBI-60 |
| Pieza final RDE-20 | Pieza final RBE-60 |



TIPO ANTIGUO



TIPO NUEVO

| Ref. | Dimensiones mm. | | | | Largo | Conector |
|-----------------|-----------------|----|-----|----|-------|-------------------------|
| | W | W1 | H | H1 | | |
| RD-20 | 20 | 8 | 6 | 4 | 1 m | RDT-20, RDM-20 |
| RD-20BN | 20 | 8 | 6 | 4 | 1 m | RDI-20, RDO-20 |
| RD-20MW | 20 | 8 | 6 | 4 | 1 m | RDL-20, RDE-20 |
| RD-20LX | 20 | 8 | 6 | 4 | 1 m | RBL-20, RBT-20 |
| RD-20DX | 20 | 8 | 6 | 4 | 1 m | |
| RD-30 | 30 | 11 | 8 | 6 | 1 m | RDT-30, RDM-30 |
| RD-30BN | 30 | 11 | 8 | 6 | 1 m | RDI-30, RDO-30 |
| RD-30MW | 30 | 11 | 8 | 6 | 1 m | RDL-30, RDE-30 |
| RD-30LX | 30 | 11 | 8 | 6 | 1 m | RBL-30, RBT-30 |
| RD-30DX | 30 | 11 | 8 | 6 | 1 m | |
| RD-40 | 40 | 16 | 9.5 | 7 | 1 m | RDT-40, RDM-40 |
| RD-40BN | 40 | 16 | 9.5 | 7 | 1 m | RDI-40, RDO-40 |
| RD-40MW | 40 | 16 | 9.5 | 7 | 1 m | RDL-40, RDE-40 |
| RD-40LX | 40 | 16 | 9.5 | 7 | 1 m | RBL-40, RBT-40 |
| RD-40DX | 40 | 16 | 9.5 | 7 | 1 m | |
| RD-50 | 50 | 20 | 11 | 8 | 1 m | RDT-50, RDM-50 |
| RD-50BN | 50 | 20 | 11 | 8 | 1 m | RDI-50, RDO-50 |
| RD-50MW | 50 | 20 | 11 | 8 | 1 m | RDL-50, RDE-50 |
| RD-50LX | 50 | 20 | 11 | 8 | 1 m | RBL-50, RBT-50 |
| RD-50DX | 50 | 20 | 11 | 8 | 1 m | |
| RD-60 | 60 | 30 | 13 | 9 | 1 m | RDT-60, RDM-60 |
| RD-60BN | 60 | 30 | 13 | 9 | 1 m | RDI-60, RDO-60 |
| RD-60MW | 60 | 30 | 13 | 9 | 1 m | RDL-60, RDE-60 |
| RD-60LX | 60 | 30 | 13 | 9 | 1 m | RBL-60, RBT-60 |
| RD-60DX | 60 | 30 | 13 | 9 | 1 m | |
| RD-70 | 70 | 40 | 15 | 10 | 1 m | RDT-70, RDM-70 |
| RD-70BN | 70 | 40 | 15 | 10 | 1 m | RDI-70, RDO-70 |
| RD-70MW | 70 | 40 | 15 | 10 | 1 m | RDL-70, RDE-70 |
| RD-70LX | 70 | 40 | 15 | 10 | 1 m | RBL-70, RBT-70 |
| RD-70DX | 70 | 40 | 15 | 10 | 1 m | |
| RD-90 | 90 | 45 | 19 | 15 | 1 m | RDT-90, RDM-90 |
| RD-90BN | 90 | 45 | 19 | 15 | 1 m | RDI-90, RDO-90 |
| RD-90MW | 90 | 45 | 19 | 15 | 1 m | RDL-90, RDE-90 |
| RD-90LX | 90 | 45 | 19 | 15 | 1 m | RBL-90, RBT-90 |
| RD-90DX | 90 | 45 | 19 | 15 | 1 m | |
| RD-120 | 120 | 70 | 25 | 21 | 1 m | RDT-120, RDM-120 |
| RD-120BN | 120 | 70 | 25 | 21 | 1 m | RDI-120, RDO-120 |
| RD-120MW | 120 | 70 | 25 | 21 | 1 m | RDL-120, RDE-120 |
| RD-120LX | 120 | 70 | 25 | 21 | 1 m | RBL-120, RBT-120 |
| RD-120DX | 120 | 70 | 25 | 21 | 1 m | |

Canaleta flexible serie SRD



Material: PVC.

Color standard: ■ Gris.

Colores bajo demanda: □ Blanco, ■ marfil, ■ marrón.

PVC blando. Envasado en rollo para más fácil almacenaje y corte del largo necesario. Para aplicaciones temporales o permanentes. Se puede suministrar con el adhesivo de doble cara.

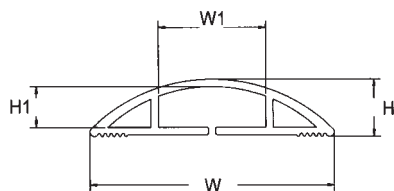

SRD-65

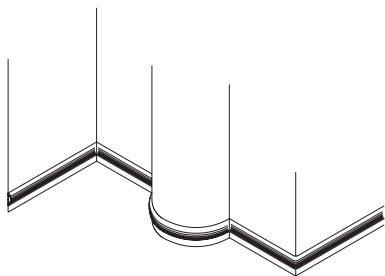

| Ref. | Dimensiones mm. | | | | Largo |
|-------------------|-----------------|------|------|------|--------|
| | W | W1 | H | H1 | |
| SRD-25 | 25.4 | 7.4 | 5.8 | 3.8 | 183 cm |
| SRD-25BN | 25.4 | 7.4 | 5.8 | 3.8 | 183 cm |
| SRD-25MW | 25.4 | 7.4 | 5.8 | 3.8 | 183 cm |
| SRD-25BK | 25.4 | 7.4 | 5.8 | 3.8 | 183 cm |
| SRD-50 | 50.8 | 14.8 | 11.6 | 7.8 | 183 cm |
| SRD-50BN | 50.8 | 14.8 | 11.6 | 7.8 | 183 cm |
| SRD-50MW | 50.8 | 14.8 | 11.6 | 7.8 | 183 cm |
| SRD-50BK | 50.8 | 14.8 | 11.6 | 7.8 | 183 cm |
| SRD-65 | 66 | 19 | 15.3 | 10.9 | 183 cm |
| SRD-65BN | 66 | 19 | 15.3 | 10.9 | 183 cm |
| SRD-65MW | 66 | 19 | 15.3 | 10.9 | 183 cm |
| SRD-65BK | 66 | 19 | 15.3 | 10.9 | 183 cm |
| SRD-75 | 76.2 | 22 | 17.4 | 11.6 | 183 cm |
| SRD-75BN | 76.2 | 22 | 17.4 | 11.6 | 183 cm |
| SRD-75MW | 76.2 | 22 | 17.4 | 11.6 | 183 cm |
| SRD-75BK | 76.2 | 22 | 17.4 | 11.6 | 183 cm |
| SRD-100 | 101.6 | 29.4 | 23.2 | 15.4 | 183 cm |
| SRD-100BN | 101.6 | 29.4 | 23.2 | 15.4 | 183 cm |
| SRD-100MW | 101.6 | 29.4 | 23.2 | 15.4 | 183 cm |
| SRD-100BK | 101.6 | 29.4 | 23.2 | 15.4 | 183 cm |
| SRD-251 | 25.4 | 7.4 | 5.8 | 3.8 | 1 m |
| SRD-251BN | 25.4 | 7.4 | 5.8 | 3.8 | 1 m |
| SRD-251MW | 25.4 | 7.4 | 5.8 | 3.8 | 1 m |
| SRD-251BK | 25.4 | 7.4 | 5.8 | 3.8 | 1 m |
| SRD-501 | 50.8 | 14.8 | 11.6 | 7.8 | 1 m |
| SRD-501BN | 50.8 | 14.8 | 11.6 | 7.8 | 1 m |
| SRD-501MW | 50.8 | 14.8 | 11.6 | 7.8 | 1 m |
| SRD-501BK | 50.8 | 14.8 | 11.6 | 7.8 | 1 m |
| SRD-651 | 66 | 19 | 15.3 | 10.9 | 1 m |
| SRD-651BN | 66 | 19 | 15.3 | 10.9 | 1 m |
| SRD-651MW | 66 | 19 | 15.3 | 10.9 | 1 m |
| SRD-651BK | 66 | 19 | 15.3 | 10.9 | 1 m |
| SRD-751 | 76.2 | 22 | 17.4 | 11.6 | 1 m |
| SRD-751BN | 76.2 | 22 | 17.4 | 11.6 | 1 m |
| SRD-751MW | 76.2 | 22 | 17.4 | 11.6 | 1 m |
| SRD-751BK | 76.2 | 22 | 17.4 | 11.6 | 1 m |
| SRD-1001 | 101.6 | 29.4 | 23.2 | 15.4 | 1 m |
| SRD-1001BN | 101.6 | 29.4 | 23.2 | 15.4 | 1 m |
| SRD-1001MW | 101.6 | 29.4 | 23.2 | 15.4 | 1 m |
| SRD-1001BK | 101.6 | 29.4 | 23.2 | 15.4 | 1 m |

CON BASE ADHESIVA - CON BASE ADHESIVA

CON BASE ADHESIVA - CON BASE ADHESIVA



Canaleta de tipo "redondo"

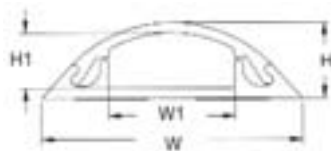

Material: PVC rígido, autoextinguible y resistente a grandes impactos.
 Temperatura máxima: 85° C. Color standard: ■ Gris. Colores bajo demanda:
 □ Blanco, ■ marfil, ■ marrón. Acabada con adhesivo de doble cara de alta calidad en la base para un pegado permanente, recomendable para instalar en suelos donde deban pasar ruedas.

| Ref. | Dimensiones mm. | | | | Largo |
|-----------------|-----------------|------|------|------|-------|
| | W | W1 | H | H1 | |
| RDA-30 | 28.8 | 11.0 | 7.4 | 5.2 | 1 m |
| RDA-30BN | 28.8 | 11.0 | 7.4 | 5.2 | 1 m |
| RDA-30MW | 28.8 | 11.0 | 7.4 | 5.2 | 1 m |
| RDA-30LX | 28.8 | 11.0 | 7.4 | 5.2 | 1 m |
| RDA-30DX | 28.8 | 11.0 | 7.4 | 5.2 | 1 m |
| RDA-40 | 38.5 | 18.8 | 11.5 | 8.5 | 1 m |
| RDA-40BN | 38.5 | 18.8 | 11.5 | 8.5 | 1 m |
| RDA-40MW | 38.5 | 18.8 | 11.5 | 8.5 | 1 m |
| RDA-40LX | 38.5 | 18.8 | 11.5 | 8.5 | 1 m |
| RDA-40DX | 38.5 | 18.8 | 11.5 | 8.5 | 1 m |
| RDA-50 | 50.0 | 20.3 | 12.3 | 8.8 | 1 m |
| RDA-50BN | 50.0 | 20.3 | 12.3 | 8.8 | 1 m |
| RDA-50MW | 50.0 | 20.3 | 12.3 | 8.8 | 1 m |
| RDA-50LX | 50.0 | 20.3 | 12.3 | 8.8 | 1 m |
| RDA-50DX | 50.0 | 20.3 | 12.3 | 8.8 | 1 m |
| RDA-60 | 60.0 | 33.3 | 13.8 | 10.7 | 1 m |
| RDA-60BN | 60.0 | 33.3 | 13.8 | 10.7 | 1 m |
| RDA-60MW | 60.0 | 33.3 | 13.8 | 10.7 | 1 m |
| RDA-60LX | 60.0 | 33.3 | 13.8 | 10.7 | 1 m |
| RDA-60DX | 60.0 | 33.3 | 13.8 | 10.7 | 1 m |

Canaleta de una sola pieza

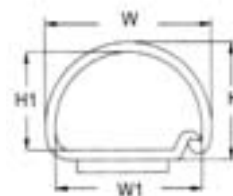

| Ref. | Dimensiones mm. | | | | | Para conector |
|----------------|-----------------|-----|------|------|-------|---------------------------|
| | H | H1 | W | W1 | Largo | |
| RTF10WE | 10.8 | 8.2 | 13.1 | 11.6 | 1.5 m | RTFL-10WE Tipo "L" |
| | | | | | | RTFI-10WE Interior |
| | | | | | | RTFO-10WE Tipo "T" |
| | | | | | | RTFM-10WE Plano |



Protege-cables decorativo

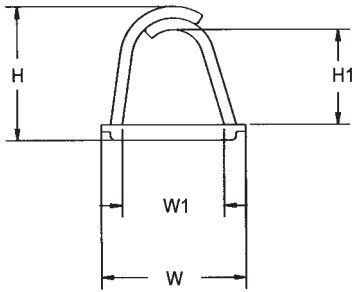
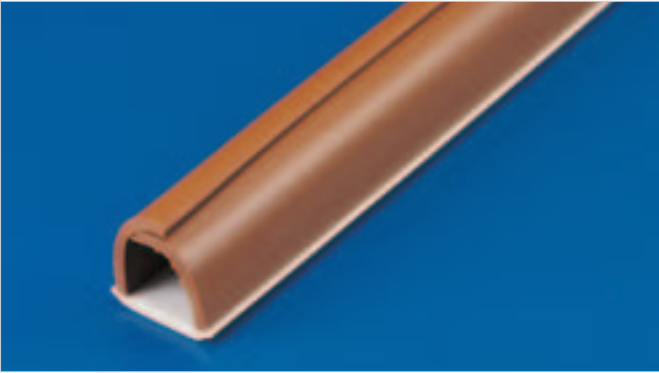

Material: PVC.
 Base rígida de PVC con adhesivo a doble cara. Cuerpo blando con apertura para inserción del cable. Para cables hasta 10 mm.
 Color: ■ Marrón.

| Ref. | Dimensiones mm. | | | | Largo |
|---------------|-----------------|------|------|-----|-------|
| | W | W1 | H | H1 | |
| RSD-10 | 15 | 10.5 | 13.8 | 9.8 | 1 m |

Tapa-cables

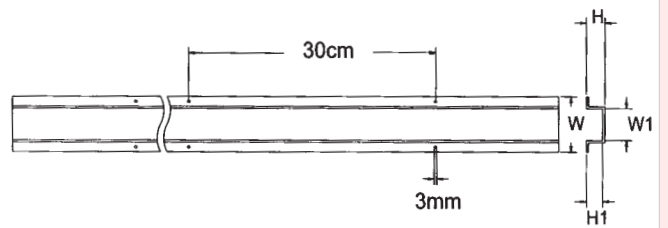
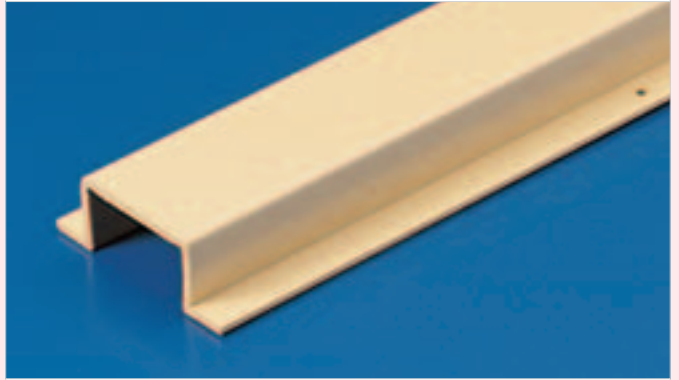

Material: PVC. Color: ■ Crema.

| Ref. | Dimensiones mm. | | | | Largo |
|----------------|-----------------|----|------|------|-------|
| | W | W1 | H | H1 | |
| CD-3820 | 67.2 | 38 | 22.3 | 19.8 | 1.2 m |

¿Sabía qué...



...X.B. components, s.a. cuenta con una página web con catálogo online? Conectándose a la dirección www.xbcomponents.com podrá consultar el catálogo online, descargarlo en su ordenador en versión PDF, suscribirse al *newsletter* y acceder a todas las promociones de X.B.

delico

Conductores Auto-Electric

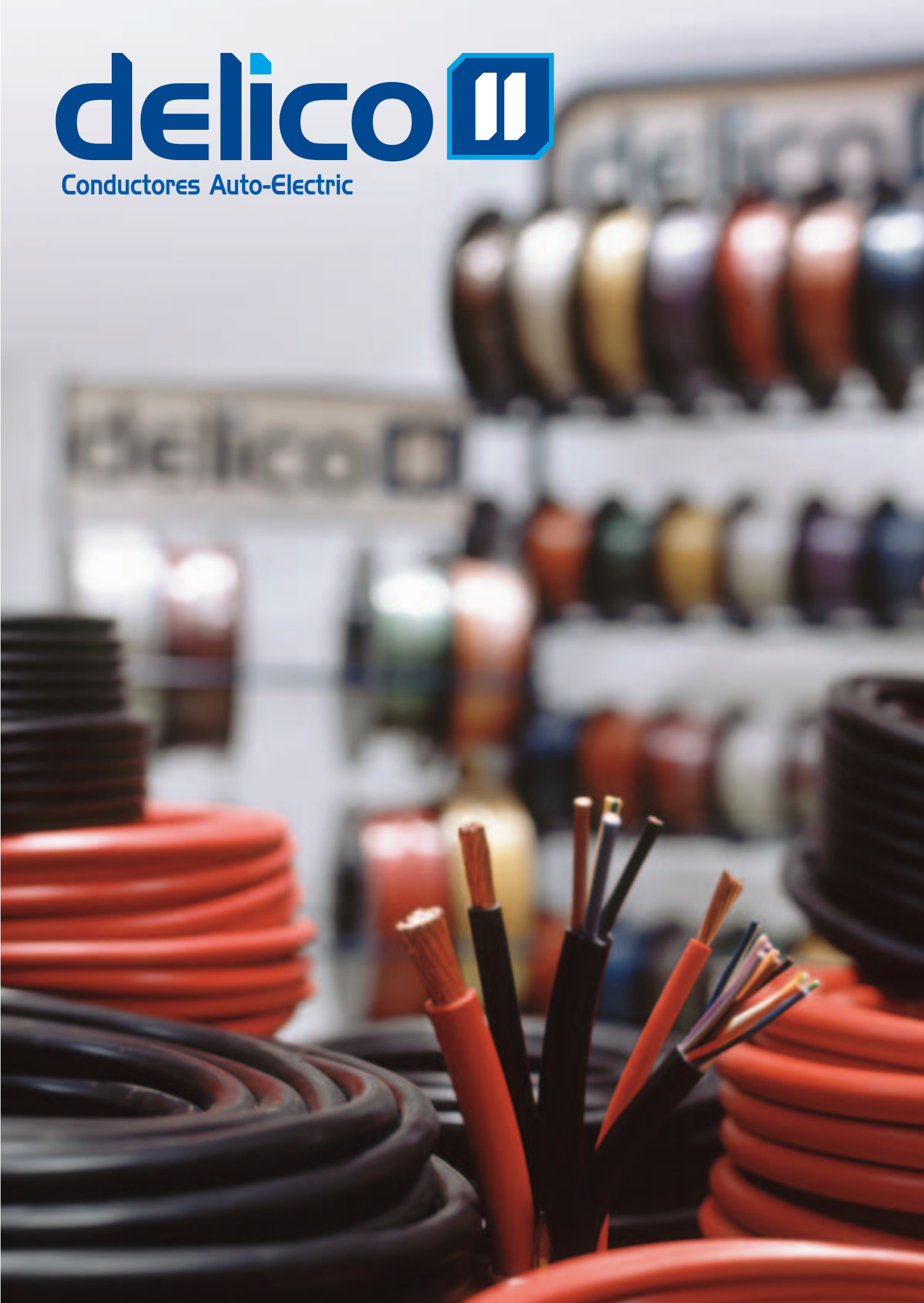

delico

Conductores Auto-Electric

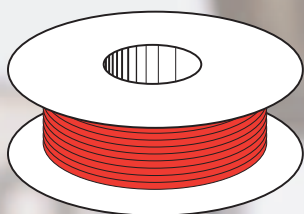

Carrete de 100 y 50 mts.

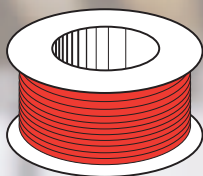

Carrete de 25 mts.

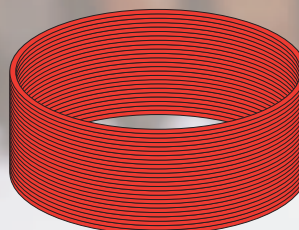

Bobinas de 50 y 25 mts.



Cable instalación unipolar en 10 colores. Cable de arranque en rojo y negro.



Cable paralelo bicolor.

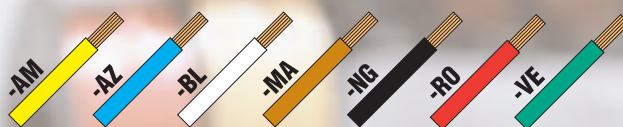

Cable manguera de 2 a 7 conductores (colores interiores).

Cable de arranque unipolar con aislante de **PVC** y **ACRILICO**



PVC

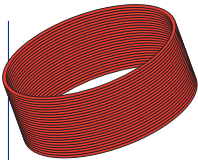

ACRILICO

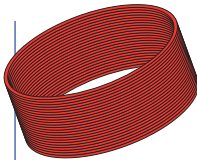

Especificaciones técnicas:

Hilo de cobre electrolítico recocido y aislante de PVC (Serie CA) y ACRÍLICO (Serie CAA) muy flexible, previsto para una temperatura máxima en servicio permanente de 70 °C. Tensión nominal: 450/750 V. Tensión de prueba: 2500 V. Según norma UNE 21022. Aplicaciones: AUTOMOCIÓN, cableado de aparatos e instrumentos en industria eléctrica, construcción y otras.



| Ref. PVC | Ref. ACRÍLICO | Sección nominal en mm ² | Composición nominal | Ø Exterior en mm | Bobina mts. | Código color y ejemplo de ref.: |
|-----------------|------------------|------------------------------------|---------------------|------------------|-------------|---------------------------------|
| CA-10-RO | CAA-10-RO | 10 | 76x0,40 | 6,50 | 25 | CA-10-RO |
| CA-10-NG | CAA-10-NG | 10 | 76x0,40 | 6,50 | 25 | CA-10-NG |
| CA-16-RO | CAA-16-RO | 16 | 120x0,40 | 7,80 | 25 | CAA-10-RO |
| CA-16-NG | CAA-16-NG | 16 | 120x0,40 | 7,80 | 25 | CAA-10-NG |
| CA-25-RO | CAA-25-RO | 25 | 175x0,40 | 10,00 | 25 | |
| CA-25-NG | CAA-25-NG | 25 | 175x0,40 | 10,00 | 25 | |
| CA-35-RO | CAA-35-RO | 35 | 252x0,40 | 11,50 | 25 | |
| CA-35-NG | CAA-35-NG | 35 | 252x0,40 | 11,50 | 25 | |
| CA-50-RO | CAA-50-RO | 50 | 357x0,40 | 13,00 | 25 | |
| CA-50-NG | CAA-50-NG | 50 | 357x0,40 | 13,00 | 25 | |
| CA-70-RO | CAA-70-RO | 70 | 532x0,40 | 15,00 | 25 | |
| CA-70-NG | CAA-70-NG | 70 | 532x0,40 | 15,00 | 25 | |
| CA-95-RO | CAA-95-RO | 95 | 646x0,40 | 17,20 | 25 | |
| CA-95-NG | CAA-95-NG | 95 | 646x0,40 | 17,20 | 25 | |



Cable paralelo bicolor negro/rojo

Especificaciones técnicas:

Hilo de cobre electrolítico recocido y aislante de PVC flexible, previsto para una temperatura máxima en servicio permanente de 85 °C.

Tensión nominal: 250/250 V. Tensión de prueba: 2000 V. Según norma UNE 21022.

Aplicaciones: AUTOMOCIÓN, Hifi-Audio Car, industria eléctrica, sonido, puntas de pruebas, instalaciones domésticas y otras.

100 / 50 m

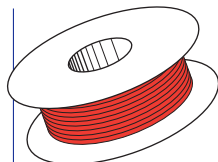

25 m

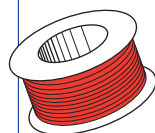

| delico | Ref. | Carrete plástico mts. | Caja máster mts. | Ref. | Carrete plástico mts. | Caja máster mts. | Sección nominal en mm ² | Composición nominal | Ø Ext. en mm |
|--------|----------------------|-----------------------|------------------|-----------------------|-----------------------|------------------|------------------------------------|---------------------|--------------|
| | CB-2x0.50-N/R | 100 | 500 | CBP-2x0.50-N/R | 25 | 250 | 2x0,50 | 2x16x0,20 | 1,9x4,0 |
| | CB-2x0.75-N/R | 100 | 500 | CBP-2x0.75-N/R | 25 | 250 | 2x0,75 | 2x24x0,20 | 2,3x4,8 |
| | CB-2x1.00-N/R | 100 | 500 | CBP-2x1.00-N/R | 25 | 250 | 2x1,00 | 2x32x0,20 | 2,5x5,2 |
| | CB-2x1.50-N/R | 50 | 250 | CBP-2x1.50-N/R | 25 | 250 | 2x1,50 | 2x30x0,25 | 2,9x6,1 |
| | CB-2x2.50-N/R | 50 | 250 | CBP-2x2.50-N/R | 25 | 250 | 2x2,50 | 2x50x0,25 | 3,3x6,8 |

Cable instalación unipolar

Especificaciones técnicas:

Hilo de cobre electrolítico recocido y aislante de PVC flexible, previsto para una temperatura máxima en servicio permanente de 70°C.

Tensión nominal: 300/500 V. Tensión de prueba: 2000 V. Según normas UNE 21022 y 21031. Aplicaciones: AUTOMOCIÓN y cableado de aparatos e instrumentos eléctricos en industria, electrodomésticos, construcción y otras.

100 / 50 m

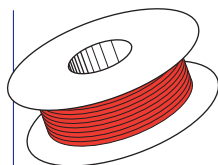

25 m

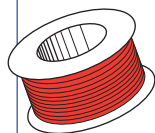

| delico | Ref. | Carrete plástico mts. | Caja máster mts. | Ref. | Carrete plástico mts. | Caja máster mts. | Sección nominal en mm ² | Composición nominal | Ø Ext. en mm | Código color y ejemplo de ref.: |
|--------|----------------|-----------------------|------------------|-----------------|-----------------------|------------------|------------------------------------|---------------------|--------------|--|
| | CI-0.50 | 100 | 500 | CIP-0.50 | 25 | 250 | 0,50 | 16x0,20 | 2,1 | CI-0.50-AM |
| | CI-0.75 | 100 | 500 | CIP-0.75 | 25 | 250 | 0,75 | 24x0,20 | 2,4 | CI-0.50-AZ |
| | CI-1.00 | 100 | 500 | CIP-1.00 | 25 | 250 | 1,00 | 32x0,20 | 2,6 | CI-0.50-BL |
| | CI-1.50 | 100 | 500 | CIP-1.50 | 25 | 250 | 1,50 | 30x0,25 | 3,0 | CI-0.50-GR |
| | CI-2.00 | 50 | 250 | CIP-2.00 | 25 | 250 | 2,00 | 28x0,30 | 3,3 | CI-0.50-MA |
| | CI-2.50 | 50 | 250 | CIP-2.50 | 25 | 250 | 2,50 | 50x0,25 | 3,6 | CI-0.50-NG |
| | CI-3.00 | 50 | 250 | CIP-3.00 | 25 | 250 | 3,00 | 45x0,30 | 4,2 | CI-0.50-NJ |
| | CI-4.00 | 50 | 250 | CIP-4.00 | 25 | 250 | 4,00 | 56x0,30 | 4,3 | CI-0.50-RO |
| | CI-6.00 | 50 | 250 | CIP-6.00 | 25 | 250 | 6,00 | 84x0,30 | 5,1 | CI-0.50-VE CI-0.50-VI |

Cable manguera flexible con aislante **ACRILICO**



Especificaciones técnicas:

Hilo de cobre electrolítico recocido y aislante ACRÍLICO muy flexible, previsto para una temperatura máxima en servicio permanente de 80 °C. Tensión nominal: 300/500 V Tensión de prueba: 2000 V. Según norma UNE 21022. Aplicaciones: AUTOMOCIÓN, línea blanca, cuadros de maniobras, lamparería, instalaciones domésticas y otras.



50 mts.

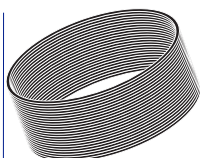

| Ref. | Sección nominal en mm ² | Composición nominal | Ø Exterior en mm | Bobina m | Composición colores conductores interiores |
|---------------------|------------------------------------|---------------------|------------------|----------|--|
| CM-2x1.00-NG | 2x1,00 | 2x32x0,20 | 6,6 | 50 | BL-NG |
| CM-3x1.00-NG | 3x1,00 | 3x32x0,20 | 7,1 | 50 | BL-MA-NG |
| CM-4x1.00-NG | 4x1,00 | 4x32x0,20 | 7,9 | 50 | BL-MA-NG-VE |
| CM-5x1.00-NG | 5x1,00 | 5x32x0,20 | 8,6 | 50 | AM-BL-MA-NG-VE |
| CM-6x1.00-NG | 6x1,00 | 6x32x0,20 | 9,2 | 50 | AM-AZ-BL-MA-NG-VE |
| CM-7x1.00-NG | 7x1,00 | 7x32x0,20 | 9,2 | 50 | AM-AZ-BL-MA-NG-RO-VE |
| CM-2x1.50-NG | 2x1,50 | 2x30x0,25 | 7,4 | 50 | BL-NG |
| CM-3x1.50-NG | 3x1,50 | 3x30x0,25 | 8,1 | 50 | BL-MA-NG |
| CM-4x1.50-NG | 4x1,50 | 4x30x0,25 | 9,0 | 50 | BL-MA-NG-VE |
| CM-5x1.50-NG | 5x1,50 | 5x30x0,25 | 10,0 | 50 | AM-BL-MA-NG-VE |
| CM-6x1.50-NG | 6x1,50 | 6x30x0,25 | 10,7 | 50 | AM-AZ-BL-MA-NG-VE |
| CM-7x1.50-NG | 7x1,50 | 7x30x0,25 | 10,7 | 50 | AM-AZ-BL-MA-NG-RO-VE |

Secciones especiales

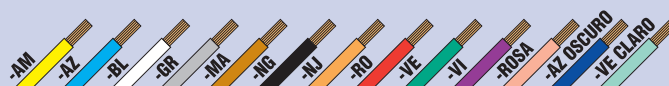

| | | | | | |
|----------------------|---------|------------|------|----|---|
| CM-13x1.00-NG | 13x1,00 | 13x32x0,20 | 13,0 | 25 | AM-AZ-BL-GR-MA-NG-NJ-RO-VE-VI-ROSA-AZ OSCURO-VE CLARO |
|----------------------|---------|------------|------|----|---|

Para freno eléctrico



| | | | | | |
|----------------------|---------|-----------|------|----|--------------|
| CM-4x6.00-NG | 4x6,00 | 4x76x0,30 | 16,0 | 25 | AZ-MA-NG-A/V |
| CM-4x10.00-NG | 4x10,00 | 4x76x0,40 | 20,0 | 25 | AZ-MA-NG-A/V |



Expositor "EXPOCABLE"



Mini Expositor para 8 Carretes de Cable DELICO



Ref.
Expocable-2002-V



Ref.
Expodelico-V



Descripción:
Expositor-mostrador de sobremesa-pared, compuesto de 4 bandejas de varilla y cartela móvil, apto para 28 carretes de cable instalación y paralelo bicolor.

Dimensiones:
455 x 875 x 200 mm.

Contenido:
Para 28 carretes de 100, 50 y 25 mts. según necesidades.

El expositor SE SUMINISTRA VACÍO y el contenido queda a voluntad del cliente.



Descripción:
Expositor de sobremesa de reducidas dimensiones

Dimensiones:
355 x 520 x 215 mm.

Contenido:
Para 8 carretes de 100, 50 y 25 mts. según necesidades.

El expositor SE SUMINISTRA VACÍO y el contenido queda a voluntad del cliente.

A close-up, low-angle shot of a mechanical keyboard. The focus is on the central and right-hand sections. The keys are a mix of white and black, with some translucent white keys. The keyboard's internal mechanism, including the stems and housing, is visible. A blue keycap is prominent in the upper center. The lighting is dramatic, with strong highlights and deep shadows, creating a sense of depth and texture. The background is blurred, emphasizing the foreground keys.

REGLETAS



REGLETAS DE CONEXIÓN

Standard - Económicas



Enchufables planas



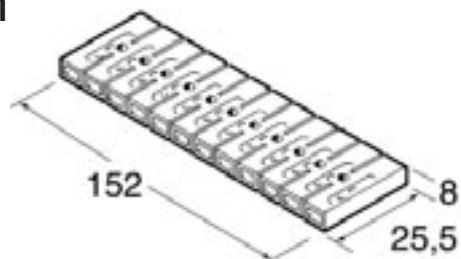

12.8011

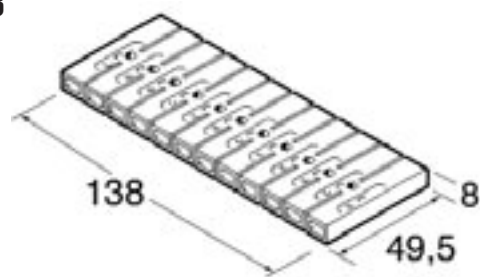

12.8023



| Ref. □ blanco | Ref. ■ negro | Sección cable mm ² | Nº de polos |  Master |
|------------------|-----------------|-------------------------------|-------------|--|
| RCE-04-0 | RCE-04-1 | 4 | 12 | 10 1.000 |
| RCE-06-0 | RCE-06-1 | 6 | 12 | 10 1.000 |
| RCE-10-0 | RCE-10-1 | 10 | 12 | 10 500 |
| RCE-16-0 | RCE-16-1 | 16 | 12 | 10 300 |
| RCE-25-0 | RCE-25-1 | 25 | 12 | 5 100 |

| Ref. | Para terminal hembra | Nº de polos |  |
|------------------|----------------------|-------------|---|
| □ 12.8011 | 6.35x0.8 | 12 | 20 |
| □ 12.8023 | 6.35x0.8 | 12 | 20 |



Regletas de conexión de polipropileno

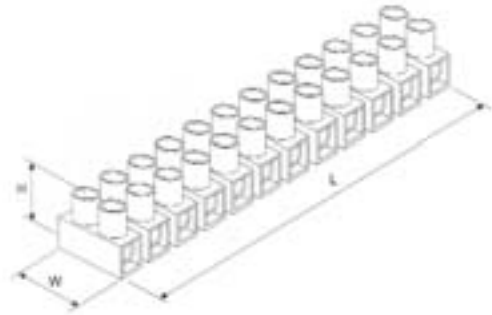

Contactos: Latón
Cuerpo: Polipropileno (PP)
Temp.: 80° C
Tornillos: Acero galvanizado
Normas: CE (BS EN 60998)

Color: □ Blanco, ■ negro
Características: Semi-rígidas.
ECONÓMICAS. Retardadoras
de la llama. Tornillos levantados
e imperdibles.

| Ref. □ blanco | Ref. ■ negro | Sección del cable mm ² | Amperaje | Voltaje | Nº de polos | Dimensiones mm. | | | |
|------------------|------------------|-----------------------------------|----------|---------|-------------|-----------------|----|----|---------|
| | | | | | | L | W | H | |
| CPP-3A | CPP-3A-1 | 4 | 3~24 A | 380 V | 12 | 93 | 17 | 14 | 10/1000 |
| CPP-5A | CPP-5A-1 | 6 | 5~32 A | 380 V | 12 | 114 | 19 | 16 | 10/1000 |
| CPP-10A | CPP-10A-1 | 10 | 10~57 A | 400 V | 12 | 125 | 21 | 17 | 10/500 |
| CPP-15A | CPP-15A-1 | 12 | 15~61 A | 400 V | 12 | 138 | 23 | 19 | 10/500 |
| CPP-30A | CPP-30A-1 | 16 | 30~76 A | 400 V | 12 | 165 | 26 | 20 | 10/300 |
| CPP-60A | CPP-60A-1 | 25 | 60~101 A | 400 V | 12 | 186 | 30 | 26 | 5/100 |

Regletas de conexión de poliamida

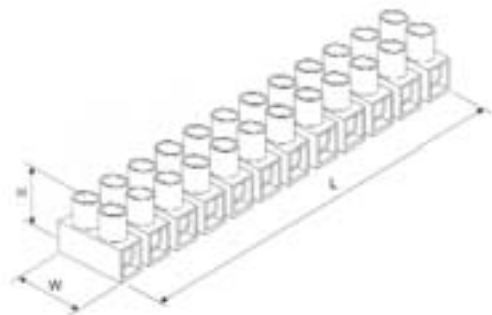

Contactos: Latón
Cuerpo: Poliamida (PA66)
Temp.: 105° C
Tornillos: Acero galvanizado
Normas: CE (BS EN 60998)

Color: □ Natural ■ negro
Características: Semi-rígidas.
Económicas. Alta temperatura.
Retardadoras de la llama. Tornillos
levantados e imperdibles.

| Ref. □ natural | Ref. ■ negro | Sección del cable mm ² | Amperaje | Voltaje | Nº de polos | Dimensiones mm. | | | |
|-------------------|------------------|-----------------------------------|----------|---------|-------------|-----------------|----|----|---------|
| | | | | | | L | W | H | |
| CPA-3A | CPA-3A-1 | 4 | 3~24 A | 380 V | 12 | 93 | 17 | 14 | 10/1000 |
| CPA-5A | CPA-5A-1 | 6 | 5~32 A | 380 V | 12 | 114 | 19 | 16 | 10/1000 |
| CPA-10A | CPA-10A-1 | 10 | 10~57 A | 400 V | 12 | 125 | 21 | 17 | 10/500 |
| CPA-15A | CPA-15A-1 | 12 | 15~61 A | 400 V | 12 | 138 | 23 | 19 | 10/500 |
| CPA-30A | CPA-30A-1 | 16 | 30~76 A | 400 V | 12 | 165 | 26 | 20 | 10/300 |
| CPA-60A | CPA-60A-1 | 25 | 60~101 A | 400 V | 12 | 186 | 30 | 26 | 5/100 |



Regletas de conexión de porcelana

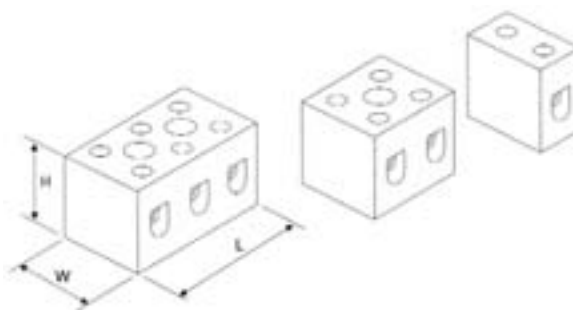
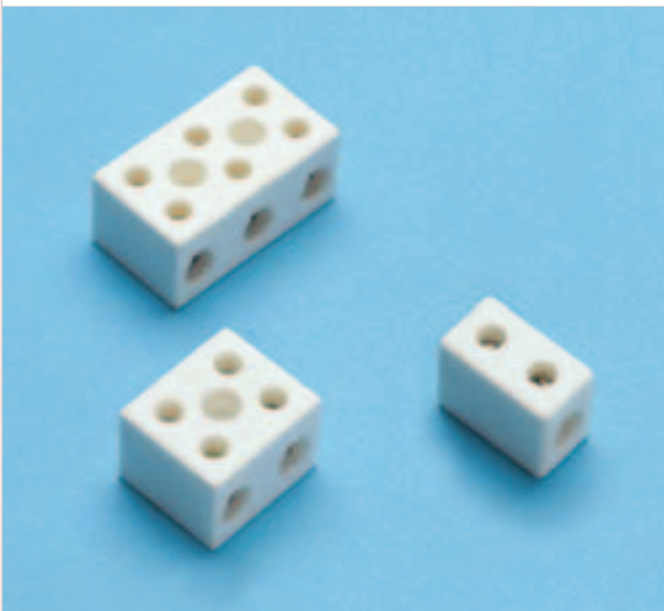

Contactos: Latón niquelado
 Cuerpo: Porcelana
 Temp.: 800° C (cuerpo)
 350° C (contactos)
 Tornillos: Acero galvanizado

Normas: CE (BS EN 60998)
 Color: □ Blanco
 Características: Duras. Muy alta temperatura. Ininflamables. Resistentes a productos químicos.

| Ref. □ blanco | Sección del cable mm ² | Amperaje | Voltaje | Nº de polos | Dimensiones mm. | | | |
|-------------------|-----------------------------------|-----------|---------|-------------|-----------------|----|----|---------|
| | | | | | L | W | H | |
| CPO-5A-1P | 4 | 5 ~ 32 A | 450 V | 1 | 12 | 13 | 16 | 25/2000 |
| CPO-5A-2P | 4 | 5 ~ 32 A | 450 V | 2 | 21 | 18 | 16 | 25/1400 |
| CPO-5A-3P | 4 | 5 ~ 32 A | 450 V | 3 | 33 | 18 | 16 | 10/900 |
| CPO-15A-1P | 10 | 15 ~ 57 A | 450 V | 1 | 13 | 21 | 20 | 20/1000 |
| CPO-15A-2P | 10 | 15 ~ 57 A | 450 V | 2 | 24 | 21 | 20 | 20/800 |
| CPO-15A-3P | 10 | 15 ~ 57 A | 450 V | 3 | 36 | 21 | 20 | 10/500 |
| CPO-30A-1P | 16 | 30 ~ 76 A | 450 V | 1 | 15 | 27 | 22 | 20/1000 |
| CPO-30A-2P | 16 | 30 ~ 76 A | 450 V | 2 | 31 | 27 | 22 | 10/400 |
| CPO-30A-3P | 16 | 30 ~ 76 A | 450 V | 3 | 48 | 27 | 22 | 10/240 |

Regletas de conexión de poliamida con base levantada

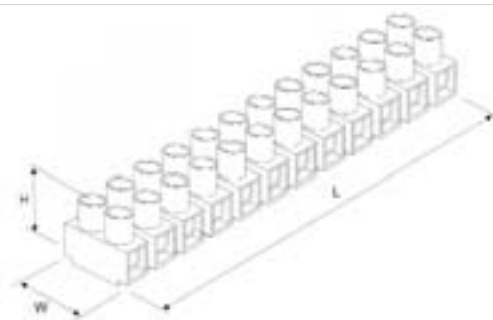

Especificaciones:
 Contactos: Latón
 Cuerpo: Poliamida (PA66)
 Temp.: 105° C
 Tornillos: Acero galvanizado

Normas: CE (BS EN 60998)
 Color: Natural, negro
 Características: Semi-rígidas. Económicas. Alta temperatura. Retardadoras de la llama.

| Ref. □ blanco | Ref. ■ negro | Sección del cable mm ² | Amperaje | Voltaje | Nº de polos | Dimensiones mm. | | | |
|------------------|-----------------|-----------------------------------|----------|---------|-------------|-----------------|----|----|---------|
| | | | | | | L | W | H | |
| CRB-6A | CRB-6A-1 | 6 | 6 ~ 32 A | 380 V | 12 | 118 | 19 | 17 | 10/1000 |

Regletas de conexión de baquelita

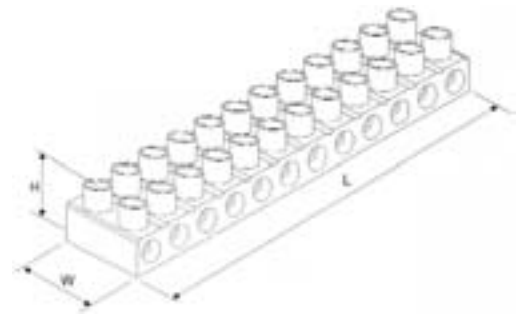

Contactos: Latón
Cuerpo: Baquelita
Temp.: 140° C
Tornillos: Acero galvanizado
Normas: CE (BS EN 60998)

Color: ■ Negro
Características:
Duras. Alta temperatura. Ininflamables.
No fundibles.

| Ref. ■ negro | Sección del cable mm ² | Amperaje | Voltaje | Nº de polos | Dimensiones mm. | | | |
|------------------|-----------------------------------|----------|---------|-------------|-----------------|----|----|--------|
| | | | | | L | W | H | |
| CBL-6 | 6 | 32 A | 500 V | 12 | 117 | 20 | 15 | 10/400 |
| CBL-10 | 10 | 57 A | 500 V | 12 | 136 | 24 | 16 | 10/300 |
| CBL-10-3P | 10 | 57 A | 500 V | 3 | 33 | 24 | 16 | 40/900 |
| CBL-16 | 16 | 76 A | 500 V | 12 | 177 | 30 | 23 | 10/200 |

Regletas derivación

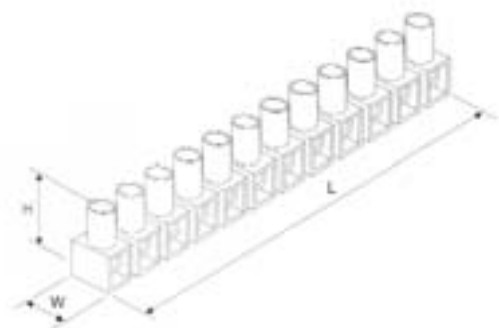

Contactos: Latón
Cuerpo: Poliamida (PA66)
Temp.: 105° C
Tornillos: Acero galvanizado
Normas: CE (BS EN 60998)

Color: ■ Negro, ■ azul, ■ marrón, ■ verde
Características: Semi-rígidas.
Fácil corte. Retardadoras de la llama.
Tornillos levantados e imperdibles.

| Ref. | Sección del cable mm ² | Amperaje | Voltaje | Nº de polos | Dimensiones mm. | | | |
|---------------------|-----------------------------------|----------|---------|-------------|-----------------|----|----|--------|
| | | | | | L | W | H | |
| ■ CSS-2.5-NG | 2.5 | 24 A | 400 V | 12 | 122 | 14 | 18 | 10/500 |
| ■ CSS-2.5-AZ | 2.5 | 24 A | 400 V | 12 | 122 | 14 | 18 | 10/500 |
| ■ CSS-2.5-MA | 2.5 | 24 A | 400 V | 12 | 122 | 14 | 18 | 10/500 |
| ■ CSS-2.5-VE | 2.5 | 24 A | 400 V | 12 | 122 | 14 | 18 | 10/500 |
| ■ CSS-10-NG | 10 | 24 A | 400 V | 12 | 122 | 14 | 18 | 10 |
| ■ CSS-10-AZ | 10 | 24 A | 400 V | 12 | 122 | 14 | 18 | 10 |
| ■ CSS-10-MA | 10 | 24 A | 400 V | 12 | 122 | 14 | 18 | 10 |
| ■ CSS-10-VE | 10 | 24 A | 400 V | 12 | 122 | 14 | 18 | 10 |



Regletas de inserción directa y tornillo

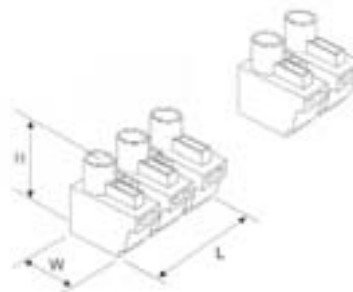
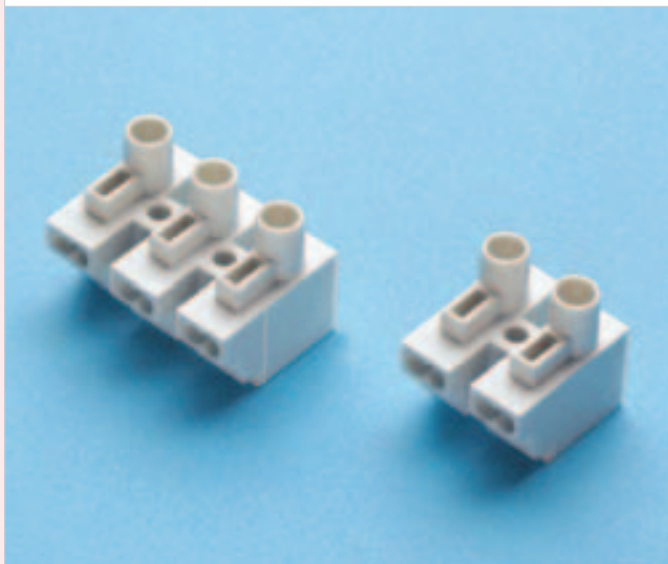

Contactos: Acero estañado
 Cuerpo: Poliamida (PA66)
 Temp.: 105° C
 Tornillos: Acero galvanizado
 Sujeciones: Acero inoxidable

Normas: CE (BS EN 60998)
 Color: □ Blanco, ■ negro
 Características: Conexión rápida.
 Rígidas. Retardadoras de la llama.
 Tornillos levantados e imperdibles.

| Ref. □ blanco | Ref. ■ negro | Sección del cable mm ² (lado del tornillo) | Para insertar cables de mm ² | Voltaje | Nº de polos | Dimensiones mm. | | | |
|-------------------|---------------------|--|--|---------|----------------|-----------------|----|----|---------|
| L | W | H | | | | | | | |
| CPS-2.5-2P | CPS-2.5-2P-1 | 2.5 | 2 x 1.5 | 380 V | 2 | 17 | 13 | 19 | 10/3000 |
| CPS-2.5-3P | CPS-2.5-3P-1 | 2.5 | 2 x 1.5 | 380 V | 3 | 28 | 13 | 19 | 10/3000 |

Regletas de conexión de poliamida

Homologaciones:

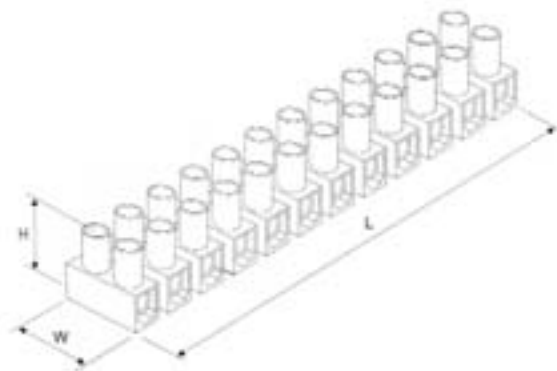
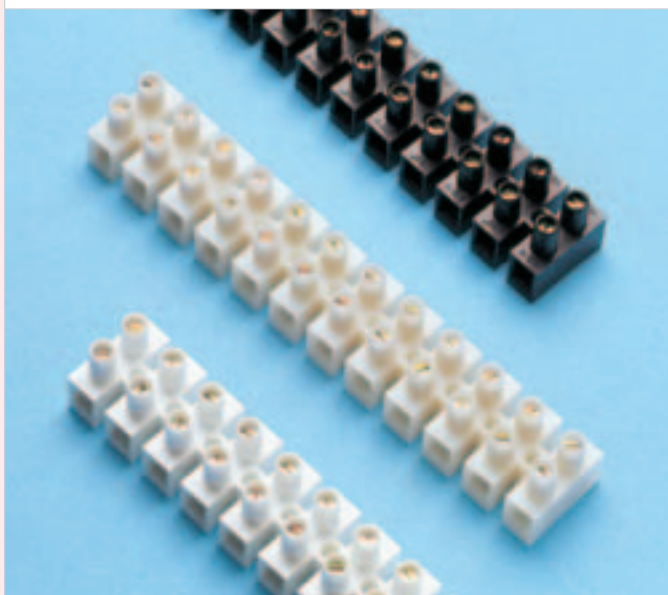

Contactos: Latón niquelado
 Cuerpo: Poliamida (PA66)
 Temp.: 105° C
 Tornillos: Acero galvanizado
 Normas: VDE...

Color: Natural, □ Blanco, ■ negro
 Características: Semi-rígidas. Alta temperatura. Retardadoras de la llama.
 Tornillos levantados e imperdibles.
-WP: CON PROTECTOR DE CABLE.



| Ref. □ blanco | Ref. ■ negro | Ref. natural | Sección del cable mm ² | Amperaje | Voltaje | Nº de polos | Dimensiones mm. | | | |
|------------------|-------------------|-------------------|--------------------------------------|----------|---------|----------------|-----------------|----|----|---------|
| L | W | H | | | | | | | | |
| ES-V-2.5 | ES-V-2.5-1 | ES-V-2.5-N | 2.5 | 24 A | 450 V | 12 | 94 | 18 | 13 | 10/1000 |
| ES-V-4 | ES-V-4-1 | ES-V-4-N | 4 | 32 A | 450 V | 12 | 115 | 20 | 15 | 10/500 |
| ES-V-6 | ES-V-6-1 | ES-V-6-N | 6 | 41 A | 450 V | 12 | 138 | 24 | 19 | 10/400 |
| ES-V-10 | ES-V-10-1 | ES-V-10-N | 10 | 57 A | 450 V | 12 | 156 | 26 | 25 | 10/200 |
| ES-V-16 | ES-V-16-1 | ES-V-16-N | 16 | 76 A | 500 V | 12 | 174 | 26 | 20 | 10/200 |
| ES-V-25 | ES-V-25-1 | ES-V-25-N | 25 | 101 A | 500 V | 12 | 203 | 37 | 26 | 10/100 |



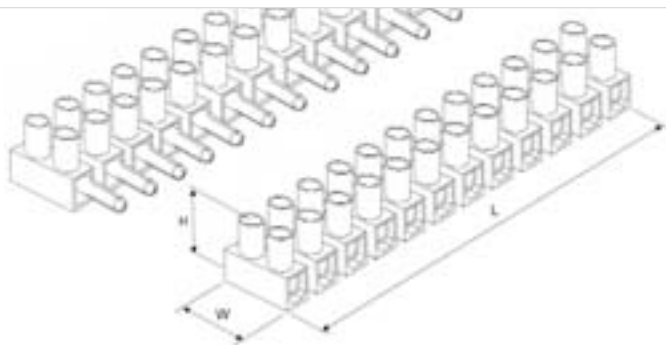
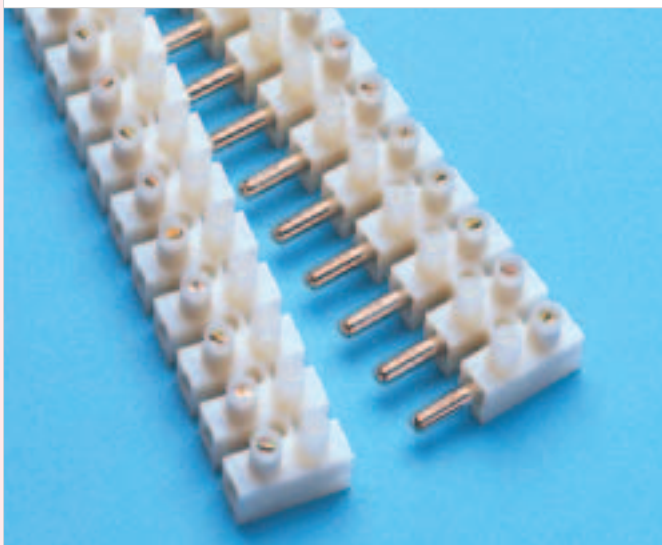

Regletas de conexión enchufables de poliamida

Homologaciones:          



Contactos: Latón niquelado
Cuerpo: Poliamida (PA66)
Temp.: 105° C
Tornillos: Acero galvanizado
Normas: VDE...

Color:  Natural,  Blanco,  negro
Características: Conexión horizontal.
Semi-rígidas. Alta temperatura.
Retardadoras de la llama. Tornillos levantados e imperdibles.



| Ref.  blanco | Ref.  negro | Ref.  natural | Sección del cable mm ² | Amperaje | Voltaje | Nº de polos | Dimensiones mm. | | |  |
|--|---|---|-----------------------------------|----------|---------|-------------|-----------------|----|----|---|
| | | | | | | | L | W | H | |
| ES-V-2.5-HP | ES-V-2.5-HP-1 | ES-V-2.5-HP-N | 2.5 | 24 A | 450 V | 12 | 94 | 18 | 13 | 50/500 |
| ES-V-4-HP | ES-V-4-HP-1 | ES-V-4-HP-N | 4 | 32 A | 450 V | 12 | 115 | 20 | 15 | 50/500 |
| ES-V-6-HP | ES-V-6-HP-1 | ES-V-6-HP-N | 6 | 41 A | 450 V | 12 | 138 | 24 | 19 | 25/200 |
| ES-V-10-HP | ES-V-10-HP-1 | ES-V-10-HP-N | 10 | 57 A | 450 V | 12 | 156 | 26 | 25 | 25/200 |



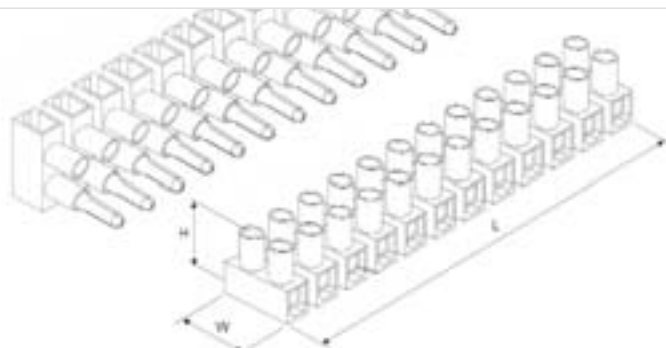

Regletas de conexión enchufables de poliamida de conexión vertical

Homologaciones:          



Contactos: Latón niquelado
Cuerpo: Poliamida (PA66)
Temp.: 105° C
Tornillos: Acero galvanizado
Normas: VDE...

Color:  Natural,  Blanco,  negro
Características: **CONEXIÓN VERTICAL.**
Semi-rígidas. Alta temperatura.
Retardadoras de la llama. Tornillos levantados e imperdibles.

| Ref.  blanco | Ref.  negro | Ref.  natural | Sección del cable mm ² | Amperaje | Voltaje | Nº de polos | Dimensiones mm. | | |  |
|--|---|---|-----------------------------------|----------|---------|-------------|-----------------|----|----|---|
| | | | | | | | L | W | H | |
| ES-V-2.5-VP | ES-V-2.5-VP-1 | ES-V-2.5-VP-N | 2.5 | 24 A | 450 V | 5 | 94 | 18 | 13 | 100/1000 |
| ES-V-4-VP | ES-V-4-VP-1 | ES-V-4-VP-N | 4 | 32 A | 450 V | 5 | 115 | 20 | 15 | 50/1000 |
| ES-V-6-VP | ES-V-6-VP-1 | ES-V-6-VP-N | 6 | 41 A | 450 V | 5 | 138 | 24 | 19 | 50/500 |
| ES-V-10-VP | ES-V-10-VP-1 | ES-V-10-VP-N | 10 | 57 A | 450 V | 5 | 156 | 26 | 25 | 25/500 |



Regletas unipolares para conexión volante

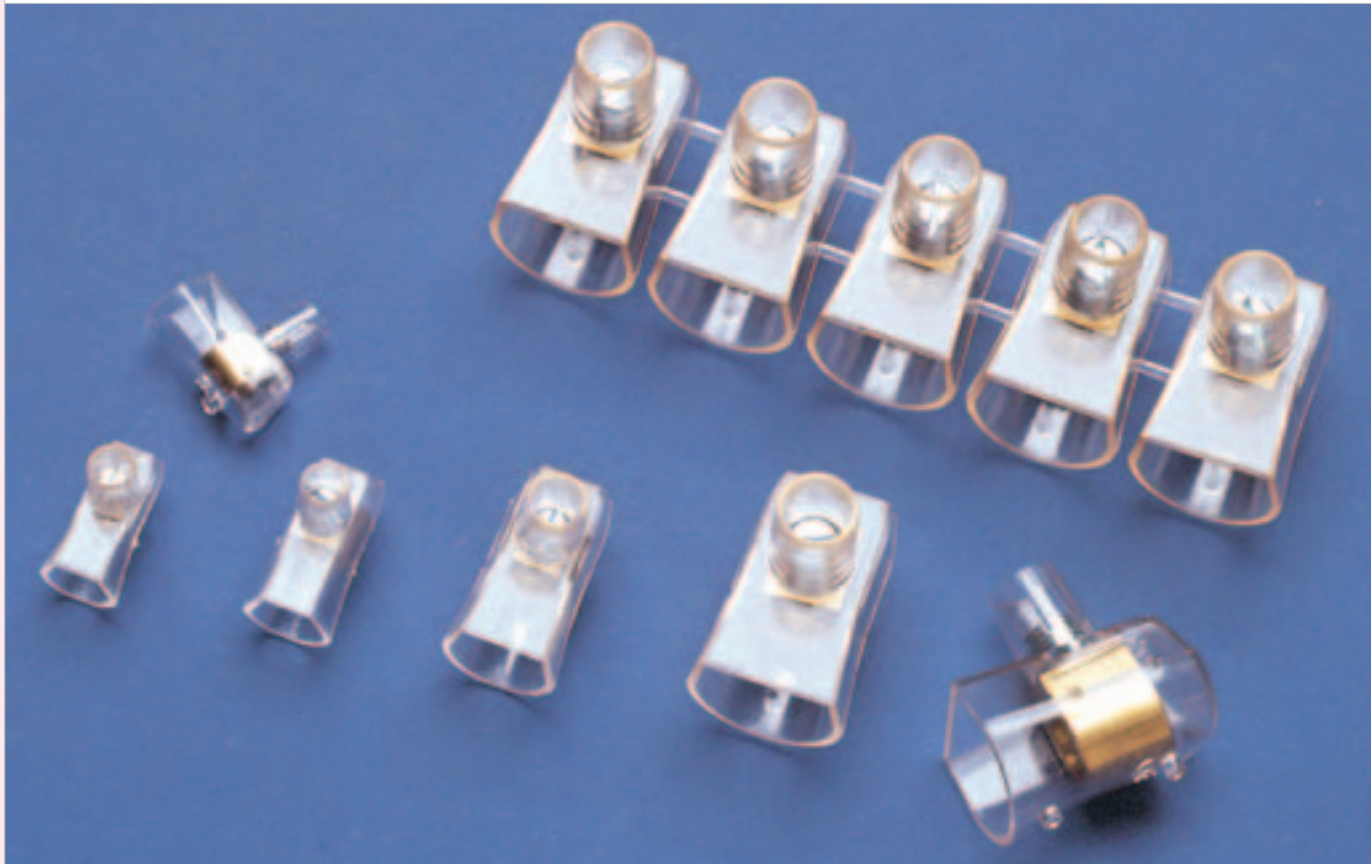

Contactos: Latón
 Cuerpo: Policarbonato (PC)
 Temp.: 130° C
 Tornillos: Acero galvanizado
 Normas: CE (BS EN 60998)

Color: Transparente
 Características: Rígidas. Fácil corte.
 Retardadoras de la llama. Tornillos
 levantados e impermeables.

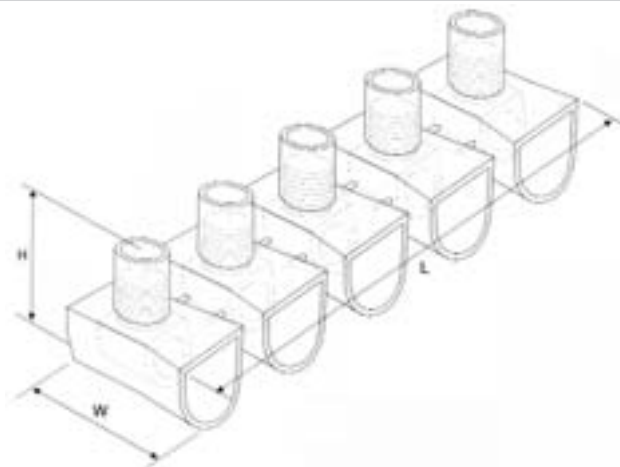

| Ref. <input checked="" type="checkbox"/> transparente | Sección del cable mm ² | Amperaje | Voltaje | N° de polos | Dimensiones mm. | | | |
|--|-----------------------------------|----------|---------|-------------|-----------------|----|----|----------|
| | | | | | L | W | H | |
| CSP-2.5 | 2.5 | 3~24 A | 500 V | 5 | 50 | 16 | 17 | 20/1000 |
| CSP-4 | 4 | 5~32 A | 500 V | 5 | 58 | 20 | 20 | 20/1000 |
| CSP-6 | 6 | 10~57 A | 500 V | 5 | 67 | 23 | 23 | 20/1000 |
| CSP-10 | 10 | 15~61 A | 500 V | 5 | 82 | 27 | 27 | 20/500 |
| CSP-16 | 16 | 30~76 A | 500 V | 5 | 111 | 31 | 33 | 20/300 |
| CSP-2.5-1 | 2.5 | 3~24 A | 500 V | 1 | 10 | 16 | 17 | 100/1000 |
| CSP-4-1 | 4 | 5~32 A | 500 V | 1 | 11 | 20 | 20 | 100/1000 |
| CSP-6-1 | 6 | 10~57 A | 500 V | 1 | 12 | 23 | 23 | 100/1000 |
| CSP-10-1 | 10 | 15~61 A | 500 V | 1 | 15 | 27 | 27 | 50/500 |
| CSP-16-1 | 16 | 30~76 A | 500 V | 1 | 20 | 31 | 33 | 50/500 |



Bloques de terminales con portafusibles para fusibles 5 x 20

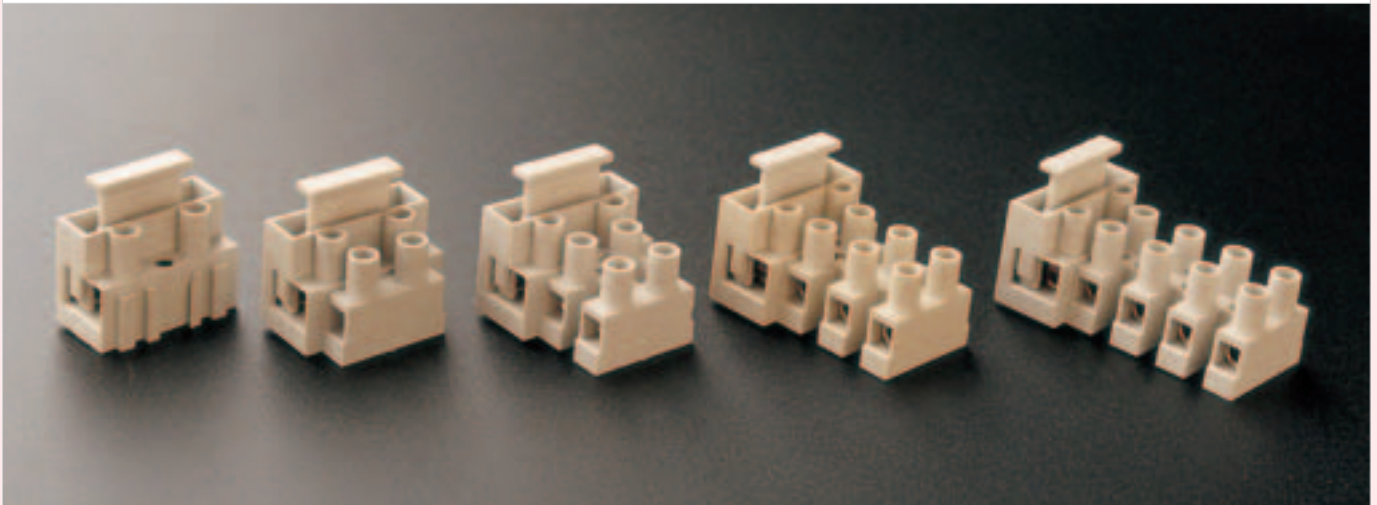

FTBN1

FTBN2

FTBN3

FTBN4

FTBN5

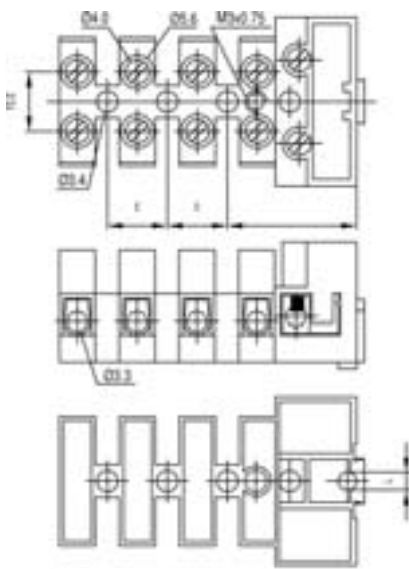

Especificación

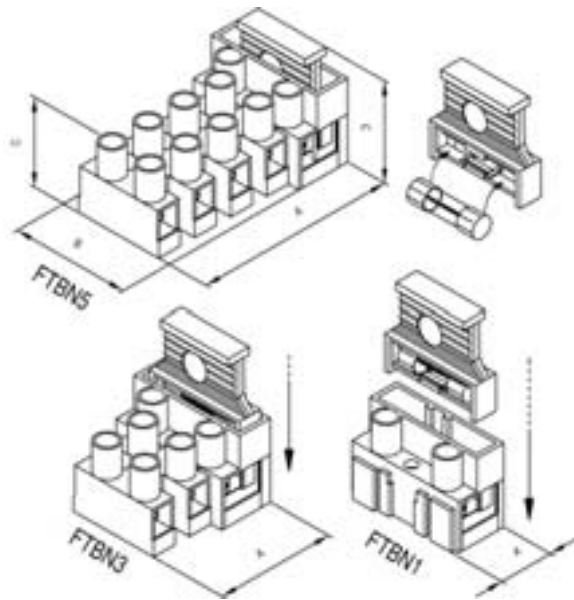

Códigos de la guía de especificaciones:

Valor de la corriente: Caja de fusibles 13 A, terminal 13 A
 Valor del voltaje: Caja de fusibles 250 VAC, terminal 450 VAC
 Temp. de trabajo: 125° C -Hasta 170 ° C durante un corto periodo de tiempo-
 Moldura: Poliamida 66 UL94-V0 con retardador de la llama
 Terminal: Latón niquelado
 Tornillos: M3 7 micras de zinc color pasivado y tropicalizado
 Cable: Permitido hasta 4 mm. Potencia disipada.

Hoja técnica:

| Voltaje del bloque de terminal | Voltaje del portafusibles | Potencia disipada | Medida del fusible |
|--------------------------------|---------------------------|-------------------|--------------------|
| 2.5 mm ² | 2.5 mm ² | 3W | 5X20 mm |
| 10A 380V | 6.3A 250V | | |

Datos técnicos:

| Ref. | Dimensiones | | | | | | |
|-------------------------|-------------|----|----|------|------------|-----------|--------|
| | A | B | C | D | E | LØ | |
| FTBN1 1 POLO | 16 | 28 | 20 | 27.5 | 10 ±0.2 | 3 ±0.2 | 10/250 |
| FTBN2 2 POLOS | 20.5 | 28 | 20 | 27.5 | 10 ±0.2 | 3 ±0.2 | 10/250 |
| FTBN3 3 POLOS | 30.5 | 28 | 20 | 27.5 | 10 ±0.2 | 3 ±0.2 | 10/200 |
| FTBN4 4 POLOS | 40.5 | 28 | 20 | 27.5 | 10 ±0.2 | 3 ±0.2 | 10/100 |
| FTBN5 5 POLOS | 50.5 | 28 | 20 | 27.5 | 10 ±0.2 | 3 ±0.2 | 10/100 |



Regletas de hilo pasante 10 polos de poliamida



De muy fácil montaje y desmontaje.

Especialmente indicada para conexión de uno o varios conductores sin cortar el cable principal.

Fácilmente dividible en los polos deseados con las manos.

| Ref. | Sección cable mm ² | Dimensiones mm. | | | |
|---------------|-------------------------------|-----------------|------|-----|----|
| | | A | H | L | |
| XBR-6 | 6 | 28,5 | 19,5 | 164 | 10 |
| XBR-10 | 10 | 28,5 | 24,0 | 204 | 10 |
| XBR-16 | 16 | 28,5 | 27,2 | 214 | 10 |
| XBR-25 | 25 | 28,5 | 29,3 | 224 | 10 |
| XBR-35 | 35 | 28,5 | 34,2 | 261 | 10 |

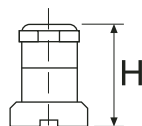
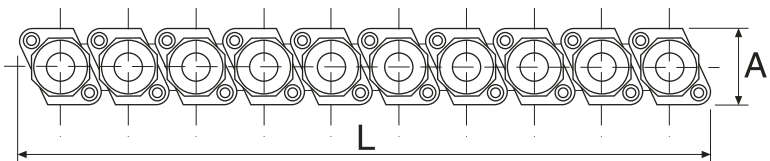

Bornes de hilo pasante unipolares de poliamida



De muy fácil montaje y desmontaje.

La formación de bloques con el número de elementos deseado es muy fácil por su sencillo sistema de engarce.

| Ref. | Sección cable mm ² | Dimensiones mm. | | | | | | | |
|----------------|-------------------------------|-----------------|----|------|----|------|----|----|--|
| | | A | B | D | H | L | L1 | | |
| XBRV-10 | 10 | 4,0 | 8 | 22,0 | 37 | 30,5 | 44 | 75 | |
| XBRV-16 | 16 | 6,0 | 9 | 25,0 | 45 | 32,0 | 48 | 50 | |
| XBRV-25 | 25 | 6,5 | 12 | 25,0 | 45 | 33,0 | 48 | 50 | |
| XBRV-35 | 35 | 7,5 | 13 | 25,0 | 47 | 33,0 | 48 | 50 | |
| XBRV-50 | 50 | 9,0 | 15 | 33,0 | 61 | 41,5 | 61 | 25 | |
| XBRV-70 | 70 | 11,0 | 17 | 38,0 | 65 | 47,0 | 70 | 20 | |

Fabricadas en baquelita

| | | | | | | | | |
|---------------------|---------|-------|----|------|-----|------|-----|----|
| XBRV-95 | 95 | 12,5 | 20 | 47,5 | 77 | 47,5 | 78 | 10 |
| XBRV-120-150 | 120/150 | 19,52 | 34 | 65,0 | 110 | 66,0 | 107 | 5 |

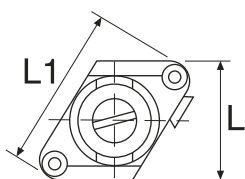
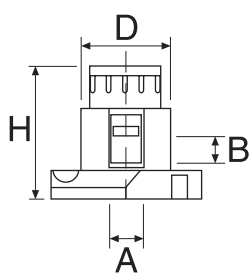

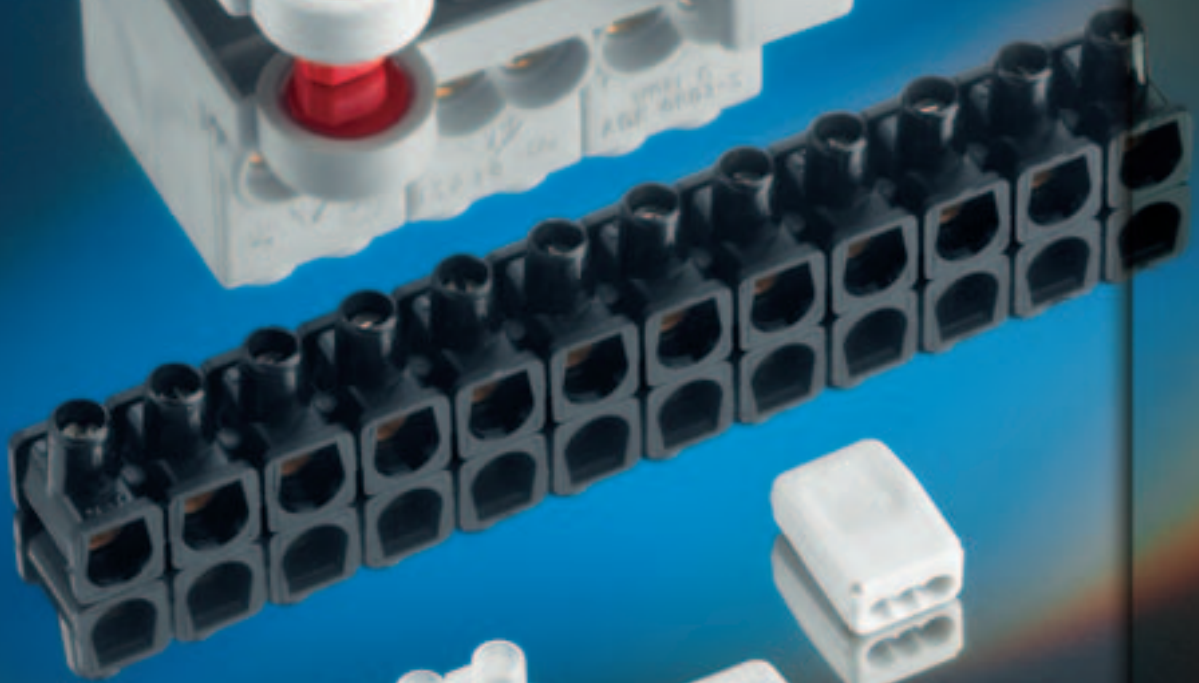

**REGLETAS
WERIT**

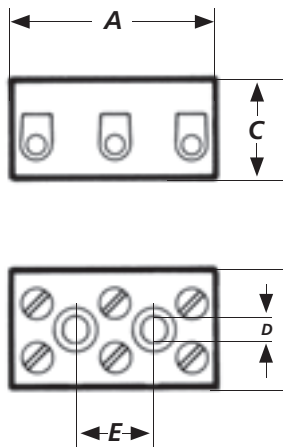
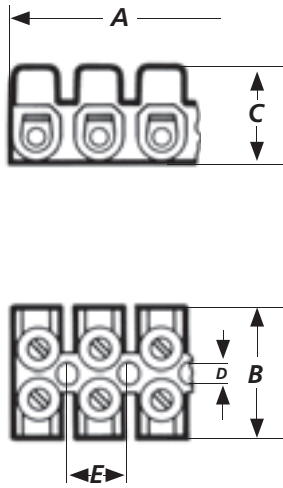
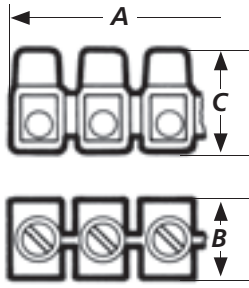

| Ref. | Nº polos | Orificio tornillo de contacto mm ² | Dimensiones en mm. | | | | | Peso en Kg 100 pcs. | Nº de b 0,75 |
|----------------|----------|---|--------------------|------|------|-----|------|---------------------|--------------|
| | | | A | B | C | D | E | | |
| 1082... | 12 | 4,6 | 122 | 15,0 | 17,5 | | | 2,60 | |
| 1084... | 12 | 5,7 x 3,4 | 117 | 15,5 | 20,0 | | | 2,30 | |
| 1085... | 12 | 8,0 x 5,1 | 165 | 17,5 | 27,5 | | | 6,70 | |
| 1182... | 12 | 4,6 | 120 | 15,0 | 17,0 | | | 2,45 | |
| 1186... | 10 | 10,0 x 5,4 | 140 | 17,0 | 30,5 | | | 7,40 | |
| 1682... | 12 | 4,6 | 122 | 15,0 | 17,5 | | | 2,65 | |
| 1684... | 12 | 5,7 x 3,4 | 117 | 15,5 | 20,0 | | | 2,35 | |
| 1052... | 12 | 6,0 | 180 | 27,0 | 21,0 | 4,5 | 15,0 | 12,00 | |
| 1102... | 12 | 2,8 | 94 | 17,5 | 12,5 | 2,9 | 8,0 | 2,18 | 10 |
| 1122... | 12 | 3,2 | 118 | 20,0 | 14,0 | 3,6 | 10,0 | 3,00 | |
| 1142... | 12 | 4,3 | 141 | 24,0 | 16,5 | 3,7 | 12,0 | 5,15 | |
| 1152... | 12 | 6,0 | 175 | 26,5 | 22,0 | 4,5 | 15,0 | 12,00 | |
| 1162... | 12 | 7,5 | 208 | 36,0 | 29,5 | 5,0 | 17,8 | 18,50 | |
| 1602... | 12 | 2,8 | 95 | 18,7 | 15,5 | 3,0 | 8,0 | 2,35 | 10 |
| 1604... | 12 | 2,8 | 95 | 18,7 | 18,4 | 3,0 | 8,0 | 2,05 | 10 |
| 1606... | 12 | 2,8 | 95 | 18,7 | 15,5 | 3,0 | 8,0 | 2,20 | 10 |
| 1608... | 12 | 2,8 | 95 | 18,7 | 18,4 | 3,0 | 8,0 | 2,10 | 10 |
| 1609... | 12 | 2,8 | 95 | 17,5 | 15,5 | 3,0 | 8,0 | 5,35 | 10 |
| 1622... | 12 | 3,2 | 118 | 20,0 | 16,8 | 3,6 | 10,0 | 3,20 | |
| 1626... | 12 | 3,2 | 118 | 20,8 | 16,8 | 3,6 | 10,0 | 3,05 | |
| 1629... | 12 | 3,2 | 115 | 20,0 | 16,0 | 3,5 | 9,8 | 7,50 | |
| 1632... | 12 | 3,6 | 118 | 20,7 | 17,8 | 3,5 | 10,0 | 3,45 | |
| 1634... | 12 | 3,6 | 118 | 20,7 | 20,3 | 3,5 | 10,0 | 2,90 | |
| 1636... | 12 | 3,6 | 118 | 20,7 | 17,8 | 3,5 | 10,0 | 3,30 | |
| 1638... | 12 | 3,6 | 118 | 20,7 | 20,3 | 3,5 | 10,0 | 3,00 | |
| 1642... | 12 | 4,3 | 141,6 | 23,8 | 17,8 | 3,7 | 12,0 | 5,25 | |
| 1644... | 12 | 4,3 | 141,6 | 23,8 | 21,2 | 3,7 | 12,0 | 4,70 | |
| 1646... | 12 | 4,3 | 141,6 | 23,8 | 17,8 | 3,7 | 12,0 | 5,05 | |
| 1648... | 12 | 4,3 | 141,6 | 23,8 | 21,2 | 3,7 | 12,0 | 4,90 | |
| 12042 | 2 | 3,6 | 18 | 21,0 | 16,5 | 3,5 | 10,0 | 1,20 | |
| 12043 | 3 | 3,6 | 28 | 21,0 | 16,5 | 3,5 | 10,0 | 1,80 | |
| 120601 | 1 | 3,2 | 8,6 | 18,0 | 14,5 | | | 0,58 | |
| 120602 | 2 | 3,2 | 18 | 15,7 | 13,5 | | | 0,95 | |
| 121601 | 1 | 6,0 | 15 | 30,0 | 23,0 | | | 2,55 | |
| 1206122 | 2 | 3,2 | 21 | 18,0 | 15,0 | 4,5 | 8,0 | 1,36 | |
| 120612 | 2 | 3,5 | 23 | 20,0 | 16,0 | 4,5 | | 1,82 | |
| 120613 | 3 | 3,5 | 35 | 20,0 | 16,0 | 4,8 | 12,2 | 2,76 | |
| 121012 | 2 | 4,3 | 24 | 23,0 | 20,0 | 5,0 | | 2,64 | |
| 121013 | 3 | 4,3 | 39 | 23,0 | 20,0 | 5,0 | 14,0 | 3,78 | |
| 121612 | 2 | 6,0 | 34 | 30,0 | 23,0 | 5,2 | | 4,95 | |
| 121613 | 3 | 6,0 | 50 | 30,0 | 23,0 | 5,0 | 18,5 | 5,63 | |

| Cables mm ² | Cables en terminal | | Cables en por terminal | | | | |
|------------------------|--------------------|-----|------------------------|--------------------|---------------------|---------------------|---------------------|
| | 1,0 | 1,5 | 4.0mm ² | 6.0mm ² | 10.0mm ² | 16.0mm ² | 25.0mm ² |
| | | 6 | 2 | | | | |
| | | 8 | 2 | 2 | | | |
| | | | 6 | 4 | 2 | | |
| | | 6 | 2 | | | | |
| | | | 8 | 6 | 3 | 2 | |
| | | 6 | 2 | | | | |
| | | 8 | 2 | 2 | | | |
| | | 10 | 8 | 6 | 2 | 2 | |
| 6 | 4 | 2 | 2 | | | | |
| 8 | 4 | 2 | 2 | 2 | | | |
| | 10 | 6 | 4 | 2 | 2 | | |
| | | 10 | 8 | 6 | 2 | 2 | |
| | | | 10 | 8 | 2 | 2 | 2 |
| 6 | 4 | 2 | 2 | | | | |
| 6 | 4 | 2 | 2 | | | | |
| 6 | 4 | 2 | 2 | | | | |
| 6 | 4 | 2 | 2 | | | | |
| 8 | 4 | 2 | 2 | 2 | | | |
| 8 | 4 | 2 | 2 | 2 | | | |
| 8 | 4 | 2 | 2 | | | | |
| 10 | 6 | 4 | 2 | 2 | | | |
| 10 | 6 | 4 | 2 | 2 | | | |
| 10 | 6 | 4 | 2 | 2 | | | |
| | 10 | 6 | 4 | 2 | 2 | | |
| | 10 | 6 | 4 | 2 | 2 | | |
| | 10 | 6 | 4 | 2 | 2 | | |
| 10 | 6 | 4 | 2 | 2 | | | |
| 10 | 6 | 4 | 2 | 2 | | | |
| 8 | 4 | 2 | 2 | 2 | | | |
| 8 | 4 | 2 | 2 | 2 | | | |
| | | 10 | 8 | 6 | 2 | 2 | |
| 8 | 4 | 2 | 2 | 2 | | | |
| 10 | 6 | 4 | 2 | 2 | | | |
| 10 | 6 | 4 | 2 | 2 | | | |
| | 10 | 6 | 4 | 2 | 2 | | |
| | 10 | 6 | 4 | 2 | 2 | | |
| | | 10 | 8 | 6 | 2 | 2 | |
| | | 10 | 8 | 6 | 2 | 2 | |









Regletas y derivaciones

Conexiones para iluminación

Regletas de porcelana

Las regletas WERIT de la serie 16xx están homologadas VDE y fabricadas en materiales de alta calidad como la poliamida.

Los tornillos de latón, levantados e imperdibles garantizan una fácil instalación y una calidad óptima.

| Ref. | Homologaciones de las regletas "norma europea" y sección asignada en mm ² | | | | | | | | |
|---------|--|---|--|---|---|---|---|---|---|
| |  |  |  |  |  |  |  |  |  |
| 1602... | 2,5 | 2,5 | 2,5 | 2,5 | 2,5 | 2,5 | 2,5 | 2,5 | 2,5 |
| 1604... | 2,5 | 2,5 | 2,5 | 2,5 | 2,5 | 2,5 | 2,5 | 2,5 | 2,5 |
| 1606... | 2,5 | 2,5 | 2,5 | 2,5 | 2,5 | 2,5 | 2,5 | 2,5 | 2,5 |
| 1608... | 2,5 | 2,5 | 2,5 | 2,5 | 2,5 | 2,5 | 2,5 | 2,5 | 2,5 |
| 1622... | 4,0 | 4,0 | 4,0 | 4,0 | 4,0 | 4,0 | 4,0 | 4,0 | 4,0 |
| 1626... | 4,0 | 4,0 | 4,0 | 4,0 | 4,0 | 4,0 | 4,0 | 4,0 | 4,0 |
| 1632... | 6,0 | 6,0 | 6,0 | 6,0 | 6,0 | 6,0 | 6,0 | 6,0 | 6,0 |
| 1634... | 6,0 | 6,0 | 6,0 | 6,0 | 6,0 | 6,0 | 6,0 | 6,0 | 6,0 |
| 1636... | 6,0 | 6,0 | 6,0 | 6,0 | 6,0 | 6,0 | 6,0 | 6,0 | 6,0 |
| 1638... | 6,0 | 6,0 | 6,0 | 6,0 | 6,0 | 6,0 | 6,0 | 6,0 | 6,0 |
| 1642... | 10,0 | 10,0 | 10,0 | 10,0 | 10,0 | 10,0 | 10,0 | 10,0 | 10,0 |
| 1644... | 10,0 | 10,0 | 10,0 | 10,0 | 10,0 | 10,0 | 10,0 | 10,0 | 10,0 |
| 1646... | 10,0 | 10,0 | 10,0 | 10,0 | 10,0 | 10,0 | 10,0 | 10,0 | 10,0 |
| 1648... | 10,0 | 10,0 | 10,0 | 10,0 | 10,0 | 10,0 | 10,0 | 10,0 | 10,0 |

Regletas sin tornillos

Regletas planas flexibles

Derivaciones planas flexibles

Para una conexión rápida y segura, WERIT ofrece regletas de conexión sin tornillo para cable sencillo de 0,75 a 1,50 mm² y de 1,00 a 2,50 mm², todas fabricadas en termoplástico resistente a la llama y homologadas según DIN EN 60998.

Esta gama se completa con las regletas de un polo sin tornillo completamente aisladas, y también con las micro-conexiones para baja tensión y las diversas propuestas de derivaciones y regletas planas.





1082

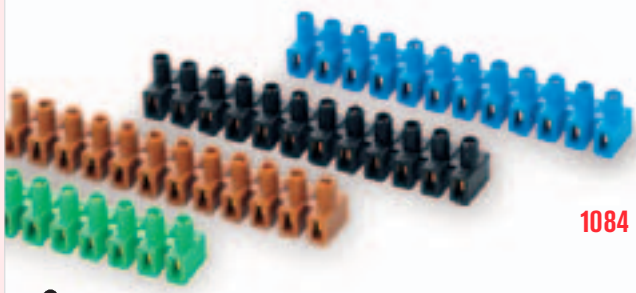

1084

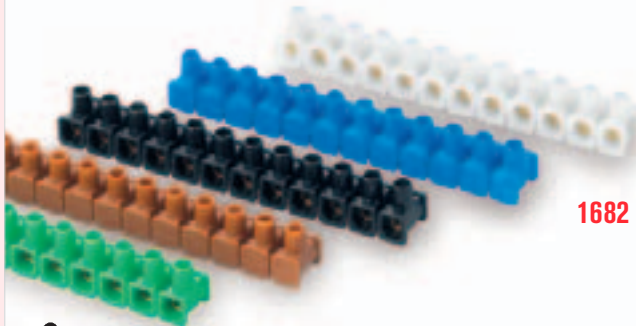

1682

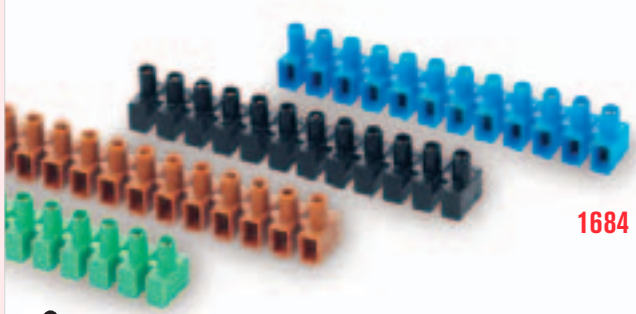

1684



Regletas de instalación

Homologadas según DIN EN 60998.

Fabricas en poliamida y tornillos de latón levantados e imperdibles.

Las referencias 1182 y 1186 están fabricadas en plástico auto-extinguible.

* Surtido: Negro 5 unid., Verde-Amarillo 2 unid., Azul 2 unid., Marrón 1 unid.

| Ref. | Color | Sección mm ² | Sección mm ² | Nº de polos | Temp. máx. °C | |
|---------------|----------|-------------------------|-------------------------|-------------|---------------|--------|
| 1082 | *Surtido | 4,0 | 4,0 | 12 | 100 | 10/250 |
| 1082-1 | | 4,0 | 4,0 | 12 | 100 | 10/250 |
| 1082-2 | | 4,0 | 4,0 | 12 | 100 | 10/250 |
| 1082-6 | | 4,0 | 4,0 | 12 | 100 | 10/250 |
| 1082-7 | | 4,0 | 4,0 | 12 | 100 | 10/250 |
| 1082-9 | | 4,0 | 4,0 | 12 | 100 | 10/250 |
| 1084 | *Surtido | 4,0 | 4,0 - 6,0 | 12 | 100 | 10/250 |
| 1084-2 | | 4,0 | 4,0 - 6,0 | 12 | 100 | 10/250 |
| 1084-6 | | 4,0 | 4,0 - 6,0 | 12 | 100 | 10/250 |
| 1084-7 | | 4,0 | 4,0 - 6,0 | 12 | 100 | 10/250 |
| 1084-9 | | 4,0 | 4,0 - 6,0 | 12 | 100 | 10/250 |
| 1085 | *Surtido | 10,0 | 10,0 | 12 | 100 | 10/100 |
| 1085-2 | | 10,0 | 10,0 | 12 | 100 | 10/100 |
| 1085-6 | | 10,0 | 10,0 | 12 | 100 | 10/100 |
| 1085-7 | | 10,0 | 10,0 | 12 | 100 | 10/100 |
| 1085-9 | | 10,0 | 10,0 | 12 | 100 | 10/100 |
| 1182 | *Surtido | | 4,0 | 12 | 95 | 10/250 |
| 1186-1 | | | 16,0 | 10 | 95 | 10/100 |
| 1186 | | | 16,0 | 10 | 95 | 10/100 |

Regletas de instalación

Homologadas según DIN EN 60998. Fabricas en poliamida y tornillos de latón levantados e imperdibles. Cerradas por un lado.

* Surtido: Negro 5 unid., Verde-Amarillo 2 unid., Azul 2 unid., Marrón 1 unid.

| Ref. | Color | Sección mm ² | Sección mm ² | Nº de polos | Temp. máx. °C | |
|---------------|----------|-------------------------|-------------------------|-------------|---------------|--------|
| 1682 | *Surtido | 4,0 | 4,0 | 12 | 100 | 10/250 |
| 1682-1 | | 4,0 | 4,0 | 12 | 100 | 10/250 |
| 1682-2 | | 4,0 | 4,0 | 12 | 100 | 10/250 |
| 1682-6 | | 4,0 | 4,0 | 12 | 100 | 10/250 |
| 1682-7 | | 4,0 | 4,0 | 12 | 100 | 10/250 |
| 1682-9 | | 4,0 | 4,0 | 12 | 100 | 10/250 |
| 1684 | *Surtido | 4,0 | 4,0 - 6,0 | 12 | 100 | 10/250 |
| 1684-2 | | 4,0 | 4,0 - 6,0 | 12 | 100 | 10/250 |
| 1684-6 | | 4,0 | 4,0 - 6,0 | 12 | 100 | 10/250 |
| 1684-7 | | 4,0 | 4,0 - 6,0 | 12 | 100 | 10/250 |
| 1684-9 | | 4,0 | 4,0 - 6,0 | 12 | 100 | 10/250 |



Regletas "norma europea"

Homologadas según DIN EN 60998.

Fabricadas en poliamida y tornillos de latón niquelado levantados e imperdibles.

| Ref. | Color | Sección mm ² | Sección mm ² | Nº de polos | Temp. máx. °C | |
|---------------|-------|-------------------------|-------------------------|-------------|---------------|--------|
| 1602-1 | | 2,5 | 2,5 | 12 | 100 | 10/250 |
| 1602-2 | | 2,5 | 2,5 | 12 | 100 | 10/250 |
| 1622-1 | | 4,0 | 4,0 - 6,0 | 12 | 100 | 10/250 |
| 1622-2 | | 4,0 | 4,0 - 6,0 | 12 | 100 | 10/250 |
| 1632-1 | | 6,0 | 6,0 | 12 | 100 | 10/250 |
| 1632-2 | | 6,0 | 6,0 | 12 | 100 | 10/250 |
| 1642-1 | | 10,0 | 10,0 | 12 | 100 | 10/200 |
| 1642-2 | | 10,0 | 10,0 | 12 | 100 | 10/200 |
| 1052-1 | | 16,0 | 16,0 | 12 | 100 | 10/100 |
| 1052-2 | | 16,0 | 16,0 | 12 | 100 | 10/100 |

Regletas "norma europea" con protector de cable

Homologadas según DIN EN 60998

Fabricadas en poliamida y tornillos de latón niquelado levantados e imperdibles.

| | | | | | | |
|---------------|--|------|------|----|-----|--------|
| 1606-1 | | 2,5 | 2,5 | 12 | 100 | 10/250 |
| 1626-1 | | 4,0 | 4,0 | 12 | 100 | 10/250 |
| 1636-1 | | 6,0 | 6,0 | 12 | 100 | 10/250 |
| 1646-1 | | 10,0 | 10,0 | 12 | 100 | 10/200 |

Regletas "norma europea" con base alta

Homologadas según DIN EN 60998

Fabricadas en poliamida y tornillos de latón niquelado levantados e imperdibles.

| | | | | | | |
|---------------|--|------|------|----|-----|--------|
| 1604-1 | | 2,5 | 2,5 | 12 | 100 | 10/250 |
| 1634-1 | | 6,0 | 6,0 | 12 | 100 | 10/250 |
| 1644-1 | | 10,0 | 10,0 | 12 | 100 | 10/200 |

Regletas "norma europea" con base alta y protector de cable

Homologadas según DIN EN 60998

Fabricadas en poliamida y tornillos de latón niquelado levantados e imperdibles.

| | | | | | | |
|---------------|--|------|------|----|-----|--------|
| 1608-1 | | 2,5 | 2,5 | 12 | 100 | 10/250 |
| 1638-1 | | 6,0 | 6,0 | 12 | 100 | 10/250 |
| 1648-1 | | 10,0 | 10,0 | 12 | 100 | 10/200 |

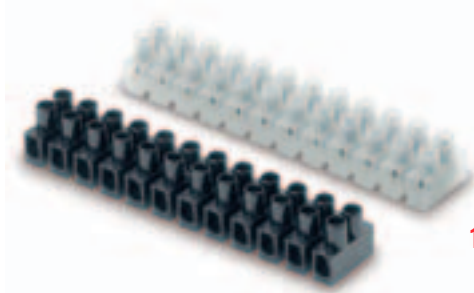

1602



1622



1642



1604

1634

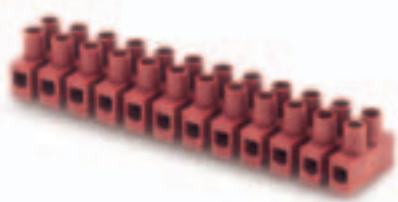

16029



16229



16329



16429

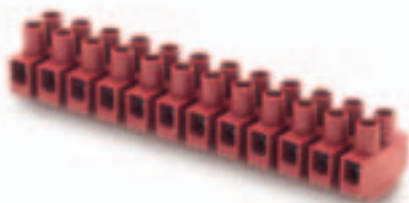

16049



16389



16489

Regletas "norma europea" para alta temperatura

Homologadas según DIN EN 60998

Fabricadas en plástico resiste a las altas temperaturas y tornillos de latón niquelado levantados e imperdibles.

| Ref. | Color | Sección mm ² | Sección mm ² | Nº de polos | Temp. máx. °C | |
|-----------------|-------|-------------------------|-------------------------|-------------|---------------|--------|
| 1602-9-H | ■ | 2,5 | 2,5 | 12 | 150 | 10/250 |
| 1622-9-H | ■ | 4,0 | 4,0 - 6,0 | 12 | 150 | 10/250 |
| 1632-9-H | ■ | 6,0 | 4,0 - 6,0 | 12 | 150 | 10/250 |
| 1642-9-H | ■ | 10,0 | 10,0 | 12 | 150 | 10/200 |

Regletas "norma europea" para alta temperatura con protector de cable

Homologadas según DIN EN 60998. Fabricadas en plástico resiste a las altas temperaturas y tornillos de latón niquelado levantados e imperdibles.

| | | | | | | |
|-----------------|---|------|------|----|-----|--------|
| 1606-9-H | ■ | 2,5 | 2,5 | 12 | 150 | 10/250 |
| 1626-9-H | ■ | 4,0 | 6,0 | 12 | 150 | 10/250 |
| 1646-9-H | ■ | 10,0 | 10,0 | 12 | 150 | 10/200 |

Regletas "norma europea" para alta temperatura con base alta

Homologadas según DIN EN 60998

Fabricadas en plástico resiste a las altas temperaturas y tornillos de latón niquelado levantados e imperdibles.

| | | | | | | |
|-----------------|---|------|------|----|-----|--------|
| 1604-9-H | ■ | 2,5 | 2,5 | 12 | 150 | 10/250 |
| 1634-9-H | ■ | 6,0 | 6,0 | 12 | 150 | 10/250 |
| 1644-9-H | ■ | 10,0 | 10,0 | 12 | 150 | 10/200 |

Regletas "norma europea" para alta temperatura con base alta y protector de cable

Homologadas según DIN EN 60998

Fabricadas en plástico resiste a las altas temperaturas y tornillos de latón niquelado levantados e imperdibles.

| | | | | | | |
|-----------------|---|------|------|----|-----|--------|
| 1608-9-H | ■ | 2,5 | 2,5 | 12 | 150 | 10/250 |
| 1638-9-H | ■ | 6,0 | 6,0 | 12 | 150 | 10/250 |
| 1648-9-H | ■ | 10,0 | 10,0 | 12 | 150 | 10/200 |



1122



1650



1609 1

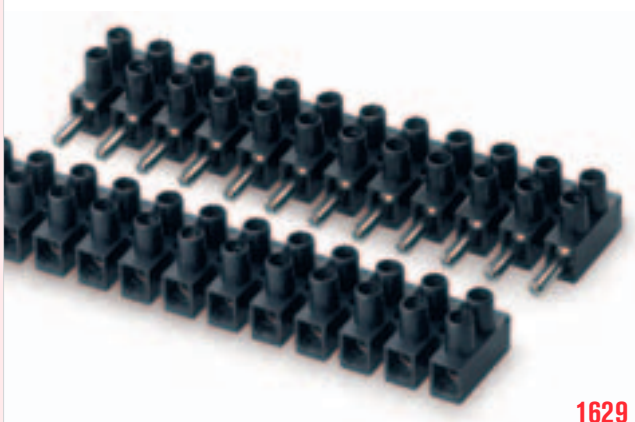

1629

Regletas flexibles

Fabricadas en plástico flexible con protección contra la llama y con tornillos de latón levantados e imperdibles.

| Ref. | Color | Sección mm ² | Nº de polos | Temp. máx. °C | |
|--------|-------|-------------------------|-------------|---------------|--------|
| 1102-1 | | 2,5 | 12 | 80 | 10/250 |
| 1102-2 | | 2,5 | 12 | 80 | 10/250 |
| 1122-1 | | 4,0 - 6,0 | 12 | 80 | 10/250 |
| 1122-2 | | 4,0 - 6,0 | 12 | 80 | 10/250 |
| 1142-1 | | 10,0 | 12 | 80 | 10/200 |
| 1142-2 | | 10,0 | 12 | 80 | 10/200 |
| 1152-1 | | 16,0 | 12 | 80 | 10/100 |
| 1152-2 | | 16,0 | 12 | 80 | 10/100 |
| 1162-1 | | 25,0 | 12 | 80 | 10/100 |

Cubierta protectora

Cubierta protectora de 3 polos fabricada en poliamida. Utilizable con las regletas 1632 y 1636. Puede atornillarse a los orificios de montaje de la regleta mediante tornillo de 3,5 mm de diámetro, no precisando una placa base.

Color: Natural

| Ref. | |
|------|------|
| 1650 | 1000 |

Regletas enchufables

Fabricadas en poliamida y tornillos de latón niquelado levantados e imperdibles. Con tornillo adicional para asegurar la clavija una vez conectada.

| Ref. | Color | Sección mm ² | Nº de polos | Temp. máx. °C | |
|--------|-------|-------------------------|-------------|---------------|-------|
| 1609-1 | | 1,5 | 12 | 100 | 5/125 |
| 1629 | | 2,5 | 12 | 100 | 5/125 |



1204 3

1204 2



120601

121601

120602



120622

120612



1201012



120613

121013

Regletas de equipamientos

Fabricadas en plástico especial resistente a altas temperaturas.
Temperatura punta máxima 250° C

| Ref. | Color | Sección mm ² | Sección mm ² | Nº de polos | Temp. máx. °C | |
|--------|-------|-------------------------|-------------------------|-------------|---------------|-----|
| 1204-2 | ■ | 2,5 | 6,0 | 2 | 220 | 100 |
| 1204-3 | ■ | 2,5 | 6,0 | 3 | 220 | 50 |

Regletas de porcelana

Homologadas según DIN EN 60998.

Fabricadas en porcelana esmaltada KER DIN 40685 y conexión de latón niquelado y tornillos de acero galvanizado con cromado amarillo.

Temperatura punta máxima 350° C

| Ref. | Color | Sección mm ² | Sección mm ² | Nº de polos | Temp. máx. °C | |
|------|-------|-------------------------|-------------------------|-------------|---------------|--|
|------|-------|-------------------------|-------------------------|-------------|---------------|--|

SIN ORIFICIO DE MONTAJE:

| | | | | | | |
|--------|---|--|------|---|-----|-----|
| 120601 | □ | | 4,0 | 1 | 200 | 100 |
| 120602 | □ | | 4,0 | 2 | 200 | 100 |
| 121601 | □ | | 16,0 | 1 | 200 | 50 |

CON ORIFICIO DE MONTAJE:

| | | | | | | |
|---------|---|------|------|---|-----|-----|
| 1206122 | □ | 2,5 | 4,0 | 2 | 200 | 100 |
| 120612 | □ | 2,5 | 4,0 | 2 | 200 | 100 |
| 120613 | □ | 2,5 | 4,0 | 3 | 200 | 100 |
| 121012 | □ | 4,0 | 10,0 | 2 | 200 | 80 |
| 121013 | □ | 4,0 | 10,0 | 3 | 200 | 50 |
| 121612 | □ | 10,0 | 16,0 | 2 | 200 | 50 |
| 121613 | □ | 10,0 | 16,0 | 3 | 200 | 40 |



Soluciones inteligentes para conexiones seguras



151503



151505



151508



152503



152505

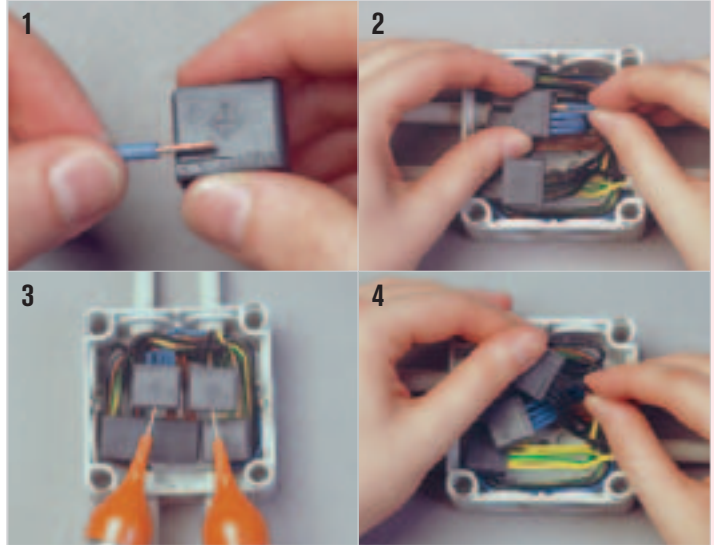

1. La muesca de la parte trasera del conector se usa para determinar la longitud precisa de pelado del cable.
2. Los muelles del interior del terminal se adaptan automáticamente a la sección del conductor.
3. Las ranuras de prueba permiten llevar a cabo pruebas de tensión de línea utilizando un equipo de pruebas estándar.
4. Libere el cableado haciendo girar el terminal de un lado a otro, tirando al mismo tiempo del conductor.

Regletas sin tornillos



Homologadas según DIN EN 60998.

Para conductores de cable de 0,75-1,5 mm² o 1,0-2,5 mm² de 450 V.

Estructura aislante de termoplástico resistente a la llama.

Temperatura máxima de uso: 100 °C.

| Ref. | Color | Sección mm ² | Puntos de contacto | Peso en Kg 100 pcs. | |
|------------------|-------|-------------------------|--------------------|---------------------|----------|
| 151503-30 | ■ | 3 x 0,75 hasta 1,5 | 3 | 0,13 | 100/2000 |
| 151505-30 | ■ | 5 x 0,75 hasta 1,5 | 5 | 0,21 | 100/2000 |
| 151508-30 | ■ | 8 x 0,75 hasta 1,5 | 8 | 0,33 | 100/2000 |
| 152503-30 | ■ | 3 x 1,0 hasta 2,5 | 3 | 0,21 | 100/2000 |
| 152505-30 | ■ | 5 x 1,0 hasta 2,5 | 5 | 0,31 | 100/2000 |



150200

Regletas de conexión de lámpara sin tornillos

Estructura aislante de 1 polo de termoplástico resistente a la llama.
Para conexión de un conductor rígido de 1,0-2,5 mm² y uno rígido / flexible de 0,5-2,5 mm².

| Ref. | Color | Sección mm ² | Puntos de contacto | Peso en Kg 100 pcs. | |
|---------------|-------|-------------------------|--------------------|---------------------|----------|
| 150200 | ■ | 2,5 | 2 | 0,165 | 100/2000 |



150808

150804

Micro regletas sin tornillos

Para instalaciones de una corriente máxima de 100 V y 6 A interconectables.
La estructura aislante es de termoplástico resistente a la llama.
Con 4 o 8 puntos de contacto de diámetro 0,6-0,8 mm².

| Ref. | Color | Puntos de contacto | Peso en Kg 100 pcs. | |
|------------------|-------|--------------------|---------------------|-----|
| 150804-30 | ■ | 4 x 0,6 - 0,8 Ø | 0,096 | 100 |
| 150808-30 | ■ | 8 x 0,6 - 0,8 Ø | 0,192 | 50 |



150700

Adaptador de colocación de micro regletas

Adaptador de montaje para adaptarse a raíles de 35 mm. para colocar 2 filas de microterminales.

Color: ■ Gris

| Ref. | |
|---------------|---|
| 150700 | 5 |

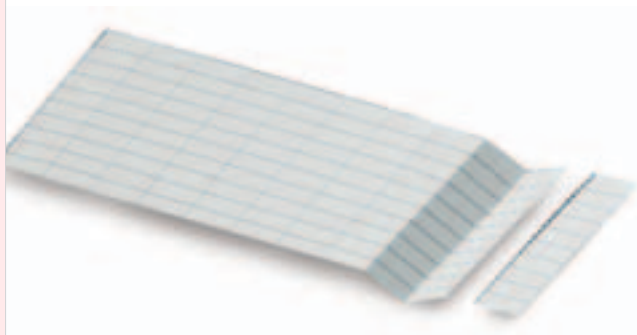

150710

Bandas de identificación

Bandas de identificación para marcar micro-terminales en un adaptador de montaje. 20 bandas perforadas por tarjeta.

Color: Blanco

Ref.



150710

5

Regletas de conexión planas y flexibles

Estructura aislante de PVC transparente.

Con conexión plana de 6,3 x 0,8 mm.

Orificio de fijación entre cada uno de los terminales individuales de 3 mm.



2451

| Ref. | Sección | Nº de polos | Temp. máx. °C | Dimensiones largo/ancho /alto mm. | Peso en Kg 100 pcs. | |
|-------------|-----------|-------------|---------------|-----------------------------------|---------------------|--------|
| 2450 | 6,3 x 0,8 | 12 | 80 | 138 / 28 / 8 | 3,05 | 10/250 |
| 2451 | 6,3 x 0,8 | 12 | 80 | 138 / 42 / 8 | 3,75 | 10/250 |
| 2452 | 6,3 x 0,8 | 12 | 80 | 138 / 50 / 8 | 4,20 | 10/250 |

Terminal de derivación de conexión plana

Estructura aislante de PVC transparente con conexión plana 6,3 x 0,8 mm.

Dos orificios de fijación.

Este terminal de derivación de conexión plana tiene gran variedad de usos y aplicaciones de acuerdo con el principio de bloque componente.



2471

| Ref. | Sección | Nº de polos | Temp. máx. °C | Dimensiones largo/ancho /alto mm. | Peso en Kg 100 pcs. | |
|-------------|-----------|-------------|---------------|-----------------------------------|---------------------|----|
| 2471 | 6,3 x 0,8 | 1 | 80 | 42 / 20,5 / 8 | 0,55 | 20 |
| 2472 | 6,3 x 0,8 | 1 | 80 | 53 / 20,5 / 8 | 0,56 | 20 |



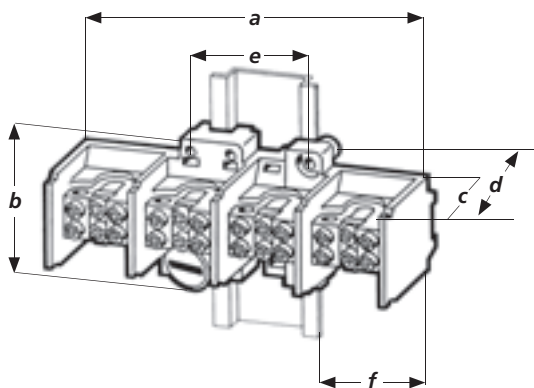

| Ref. | Nº de polos | Dimensiones mm. | | | | |
|---------------|-------------|-----------------|------|------|------|----|
| | | A | B | C | D | E |
| 12517 | 1 | 35 | 55,5 | 41,5 | 48 | 42 |
| 12317 | 1 | 35 | 55,5 | 41,5 | 48 | 42 |
| 123171 | 1 | 65 | 55,5 | 41,5 | 48 | - |
| 123172 | 1 | 65 | 55,5 | 41,5 | 48 | - |
| 12527 | 2 | 65 | 55,5 | 41,5 | 48 | 42 |
| 125272 | 2 | 65 | 55,5 | 41,5 | 48 | 42 |
| 12327 | 2 | 65 | 55,5 | 41,5 | 48 | 42 |
| 12537 | 3 | 65 | 55,5 | 41,5 | 48 | 42 |
| 12337 | 3 | 95 | 55,5 | 41,5 | 48 | 42 |
| 12547 | 4 | 125 | 55,5 | 41,5 | 48 | 42 |
| 12387 | 4 | 125 | 55,5 | 41,5 | 48 | 42 |
| 12397 | 4 | 125 | 55,5 | 41,5 | 48 | 42 |
| 12357 | 4 | 155 | 55,5 | 41,5 | 48 | 42 |
| 12367 | 4 | 155 | 55,5 | 41,5 | 48 | 42 |
| 12377 | 4 | 155 | 55,5 | 41,5 | 48 | 42 |
| 12557 | 5 | 155 | 55,5 | 41,5 | 48 | 42 |
| 12567 | 5 | 155 | 55,5 | 41,5 | 48 | 42 |
| 12577 | 5 | 155 | 55,5 | 41,5 | 48 | 42 |
| 12717 | 1 | 41 | 55,5 | 46,5 | 53 | 42 |
| 12707 | 1 | 41 | 55,5 | 46,5 | 53 | 42 |
| 12727 | 2 | 76,5 | 55,5 | 46,5 | 53 | 42 |
| 12737 | 2 | 76,5 | 55,5 | 46,5 | 53 | 42 |
| 12767 | 2 | 76,5 | 55,5 | 46,5 | 53 | 42 |
| 12747 | 4 | 148,5 | 55,5 | 46,5 | 53 | 42 |
| 12777 | 4 | 148,5 | 55,5 | 46,5 | 53 | 42 |
| 129797 | 4 | 184,5 | 55,5 | 46,5 | 53 | 42 |
| 12847 | 4 | 148,5 | 55,5 | 46,5 | 53 | 42 |
| 12757 | 5 | 184,5 | 55,5 | 46,5 | 53 | 42 |
| 12787 | 5 | 184,5 | 55,5 | 46,5 | 53 | 42 |
| 12597 | 2 | 50 | 55,5 | 32,5 | 39 | 42 |
| 12587 | 3 | 70 | 55,5 | 32,5 | 39 | 42 |
| 12607 | 3 | 70 | 55,5 | 32,5 | 39 | 42 |
| 12647 | 4 | 92 | 55,5 | 32,5 | 39 | 42 |
| 12637 | 4 | 92 | 55,5 | 32,5 | 39 | 42 |
| 12687 | 4 | 92 | 55,5 | 32,5 | 39 | 42 |
| 12657 | 5 | 114 | 55,5 | 32,5 | 39 | 42 |
| 12257 | 1 | 70 | 62 | 60 | 70 | - |
| 12267 | 1 | 70 | 62 | 60 | 70 | - |
| 12538 | 3 | 65,4 | 59,4 | 39,3 | 45,8 | - |
| 12548 | 4 | 85,7 | 59,4 | 39,3 | 45,8 | - |
| 12358 | 4 | 106 | 59,4 | 39,3 | 45,8 | - |
| 12558 | 5 | 106 | 59,4 | 39,3 | 45,8 | - |
| 125100 | 1 | 26 | 50,5 | 31,5 | 37 | - |
| 125200 | 2 | 45,5 | 50,5 | 31,5 | 37 | - |
| 125300 | 3 | 64,5 | 50,5 | 31,5 | 37 | - |
| 125400 | 4 | 84 | 50,5 | 31,5 | 37 | - |
| 125500 | 5 | 103,5 | 50,5 | 31,5 | 37 | - |

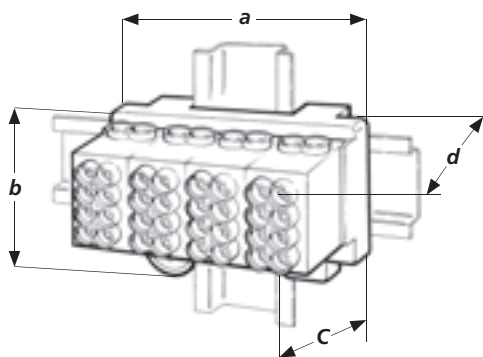



F

Terminales de derivación de red de poliamida altamente resistente a roces de 25 o 35 mm²

-

-

14,5

14,5

14,5

14,5

14,5

14,5

14,5

44,5

44,5

44,5

44,5

44,5

44,5

44,5

44,5

44,5

-

-

20,5

20,5

20,5

56,5

56,5

92,5

92,5

92,5

92,5

-

17,5

17,5

17,5

17,5

17,5

39,5

-

-

15,2

25,4

35,5

35,5

-

-

-

-

-

El dispositivo de montaje rápido universal asegura que los terminales de derivación de red WERIT pueden colocarse horizontalmente y verticalmente sobre raíles de montaje EN 50022 de 35 mm. sin necesidad de cambiar ninguna pieza de colocación.

Si los terminales están montados verticalmente, las correderas están fijadas para evitar que caigan al extraer los tornillos.

Método de colocación:

Ilustración de la izquierda: Pueden acoplarse sobre raíles de montaje EN 50022 de 35 mm. con sujeción adicional mediante un tornillo. Se pueden acoplar con tornillos en superficies uniformes sin ninguna modificación.

Ilustración de la derecha: El terminal de derivación con sistema de seguridad para el usuario, para la instalación en cabinas de medición y sistemas de sub-distribución.

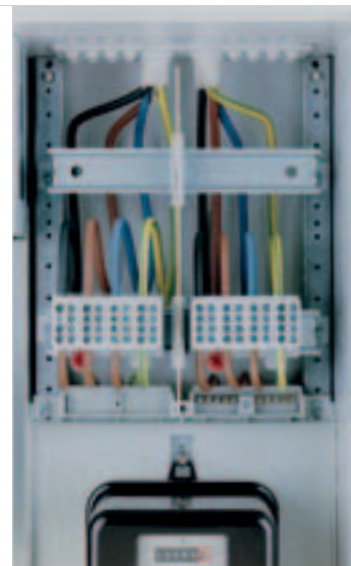

Terminales de derivación de red de 25 mm², con sistema de seguridad para el usuario según BGV A2/VDE 0603-2, tipo C.

- Caben en espacios reducidos:
3 polos = unidades con 4 salidas
4 polos = unidades con 5 salidas
5 polos = unidades con 6 salidas

- 4 puntos de contacto para cada uno de los polos.
- Orificio de taladro biselado para una inserción más fácil del conductor.
- Puente en el centro del orificio de taladro como tope para el punto de contacto.
- Los tornillos se aflojan y el terminal puede conectarse inmediatamente.
- Para una rápida colocación horizontal y verticalmente sobre un raíl de montaje de 35 mm.
- Tornillo universal con combinación pozidrive para destornillador de estrella y de cabeza ranurada.

Para montaje rápido horizontal y verticalmente sobre guía de montaje de 35 mm.



Perno excéntrico universal para uso con tornillo de ranura y destornillador tipo Phillips.

Conjunto de tornillos Pozidrive de cabeza hueca de 8 caras para el uso con destornilladores Pozidrive (tamaño 2) y destornilladores de ranura.



12517

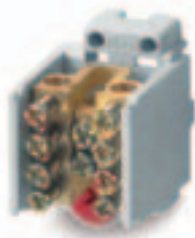

12317



123171



123172



12527

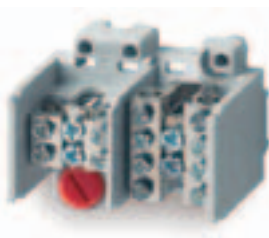

12327

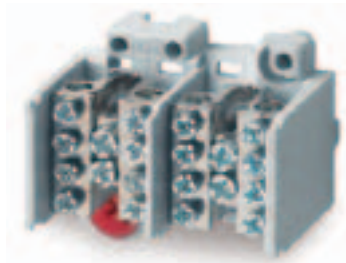

125272



12537

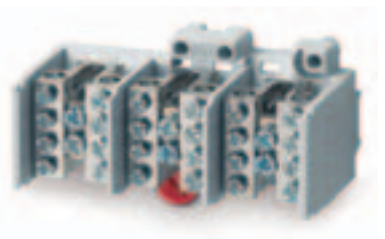

12337

Terminales de derivación de red de hasta 25 mm²

Homologados VDE 0603-2, tipo A.

Sección nominal de 25 mm², 400 V.

Unidad de montaje universal rápido en horizontal y vertical para raíles de montaje de 35 mm. según EN 50022.

Estructura aislante de poliamida resistente al roce.

Color: gris RAL 7035.

Contactos de MS58, tornillos de contacto de acero cincado con cabeza de tornillo en cruz con combinación pozidrive.

| Ref. | | Nº de polos | Tipo / Sección mm ² | Peso en Kg 100 pcs. | |
|--------|--|-------------|--|---------------------|-------|
| 12517* | | 1 | 2 Salidas 16 mm ² | 6,94 | 4/100 |
| 12317* | | 1 | 4 Salidas 16 mm ² | 9,70 | 4/100 |
| 123171 | | 1 | 6 Salidas 16 mm ² | 12,00 | 2/50 |
| 123172 | | 1 | 12 Salidas 16 mm ² | 18,30 | 2/50 |
| 12527 | | 2 | 2 Salidas 16 mm ² por polo | 13,75 | 2/50 |
| 12327 | | 2 | 1 polo con 2 Salidas 16 mm ² 1 polo con 4 Salidas 16 mm ² | 15,96 | 2/50 |
| 125272 | | 2 | 4 Salidas 16 mm ² por polo | 19,85 | 2/50 |
| 12537 | | 3 | 2 Salidas 16 mm ² por polo | 18,40 | 2/50 |
| 12337 | | 3 | 4 Salidas 16 mm ² por polo | 26,70 | 2/50 |



Terminales de derivación de red de hasta 25 mm²

Homologados VDE 0603-2, tipo A.

Sección nominal de 25 mm², 400 V.









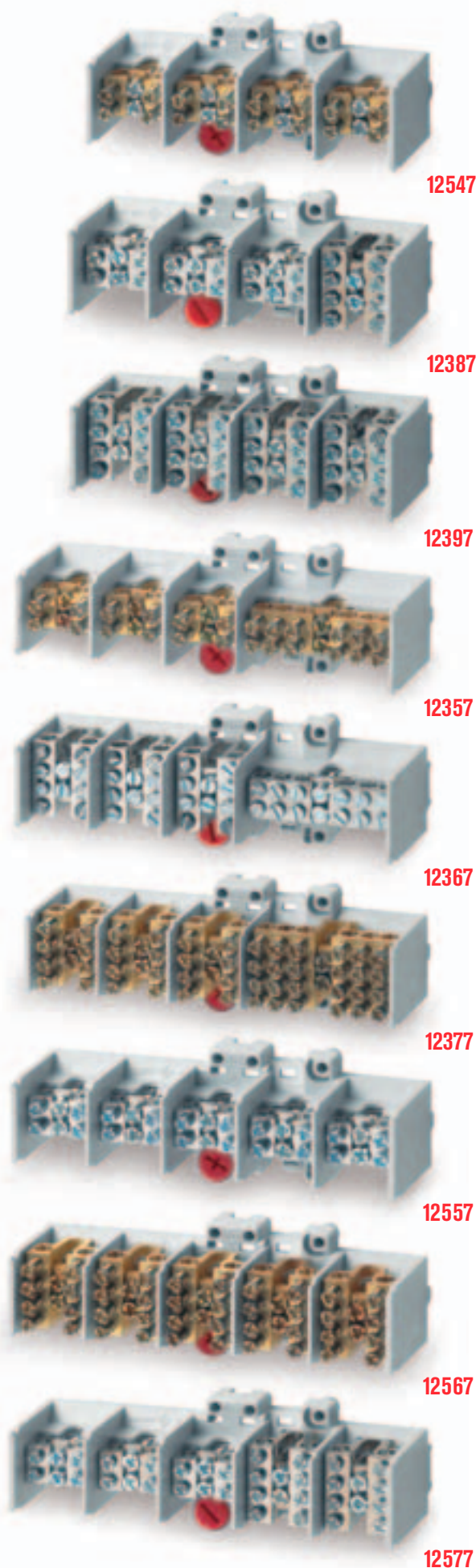

Unidad de montaje universal rápido en horizontal y vertical para raíles de montaje de 35 mm. según EN 50022.

Estructura aislante de poliamida resistente al roce.

Color: gris RAL 7035.

Contactos de MS58, tornillos de contacto de acero cincado con cabeza de tornillo en cruz con combinación pozidrive.



| Ref. | | Nº de polos | Tipo / Sección mm ² | Peso en Kg 100 pcs. |  |
|-------|---|-------------|--|---------------------|---|
| 12547 |  | 4 | 2 Salidas 16 mm ² por polo | 25,50 | 1/25 |
| 12387 |  | 4 | 3 polos con 2 Salidas 16 mm ² 1 polo con 4 Salidas 16 mm ² | 26,95 | 1/25 |
| 12397 |  | 4 | 4 Salidas 16 mm ² por polo | 35,20 | 1/25 |
| 12357 |  | 4 | 3 polos con 2 Salidas 16 mm ² 1 polo con 6 Salidas 16 mm ² | 29,50 | 1/25 |
| 12367 |  | 4 | 3 polos con 4 Salidas 16 mm ² 1 polo con 6 Salidas 16 mm ² | 36,45 | 1/25 |
| 12377 |  | 4 | 3 polos con 4 Salidas 16 mm ² 1 polo con 12 Salidas 16 mm ² | 42,55 | 1/25 |
| 12557 |  | 5 | 2 Salidas 16 mm ² por polo | 29,30 | 1/25 |
| 12567 |  | 5 | 4 Salidas 16 mm ² por polo | 43,70 | 1/25 |
| 12577 |  | 5 | 3 polos con 2 Salidas 16 mm ² 2 polos con 4 Salidas 16 mm ² | 34,90 | 1/25 |

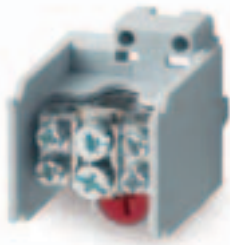

12717



12707



12727

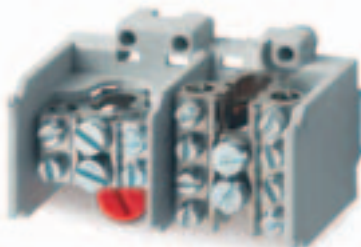

12737

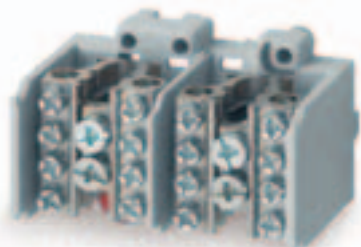

12767

Terminales de derivación de red de hasta 35 mm²

Homologados VDE 0603-2, tipo A.

Sección nominal de 25 mm², 400 V.

Unidad de montaje universal rápido en horizontal y vertical para raíles de montaje de 35 mm. según EN 50022.

Estructura aislante de poliamida resistente al roce.

Color: gris RAL 7035.

Contactos de MS 58, tornillos de contacto de acero cincado con cabeza de tornillo en cruz con combinación pozidrive.

| Ref. | | Nº de polos | Tipo / Sección mm ² | Peso en Kg 100 pcs. | |
|--------|--|-------------|--|---------------------|-------|
| 12717* | | 1 | 2 Salidas 25 mm ² | 9,55 | 4/100 |
| 12707* | | 1 | 4 Salidas 25 mm ² | 27,00 | 4/100 |
| 12727 | | 2 | 2 Salidas 25 mm ² por polo | 17,70 | 2/50 |
| 12737 | | 2 | 1 polo con 2 Salidas 25 mm ² 1 polo con 4 Salidas 25 mm ² | 22,05 | 2/50 |
| 12767 | | 2 | 4 Salidas 25 mm ² por polo | 27,10 | 2/50 |

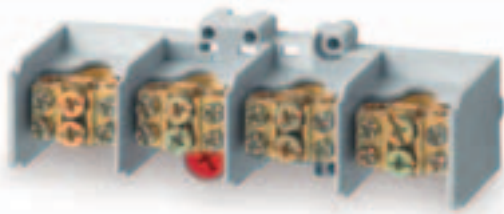

12747

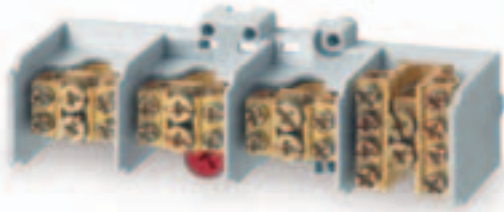

12777

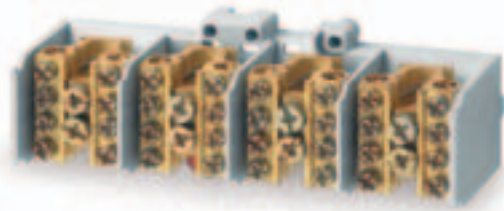

12847

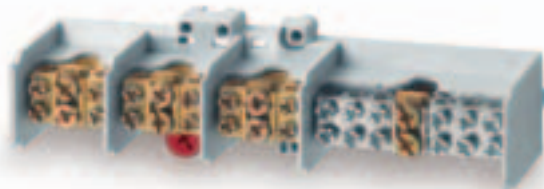

12797



12757



12787

Terminales de derivación de red de hasta 35 mm²

Homologados VDE 0603-2, tipo A.





Sección nominal de 25 mm², 400 V.

Unidad de montaje universal rápido en horizontal y vertical para raíles de montaje de 35 mm. según EN 50022.

Estructura aislante de poliamida resistente al roce.

Color: gris RAL 7035.

Contactos de MS 58, tornillos de contacto de acero cincado con cabeza de tornillo en cruz con combinación pozidrive.

| Ref. | | Nº de polos | Tipo / Sección mm ² | Peso en Kg 100 pcs. |  |
|-------|---|-------------|--|---------------------|---|
| 12747 |  | 4 | 2 Salidas 25 mm ² por polo | 34,40 | 1/25 |
| 12777 |  | 4 | 3 polos con 2 Salidas 25 mm ² 1 polo con 4 Salidas 25 mm ² | 38,65 | 1/25 |
| 12847 |  | 4 | 4 Salidas 25 mm ² por polo | 49,10 | 1/25 |
| 12797 |  | 4 | 3 polos con 2 Salidas 25 mm ² 1 polo con 6 Salidas 25 mm ² | 40,85 | 1/25 |
| 12757 |  | 5 | 2 Salidas 25 mm ² por polo | 42,05 | 1/25 |
| 12787 |  | 5 | 3 polos con 2 Salidas 25 mm ² 2 polos con 4 Salidas 25 mm ² | 50,60 | 1/25 |



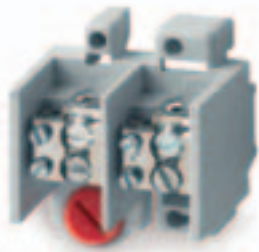

12597

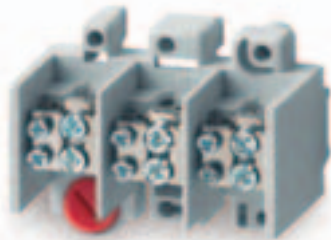

12587

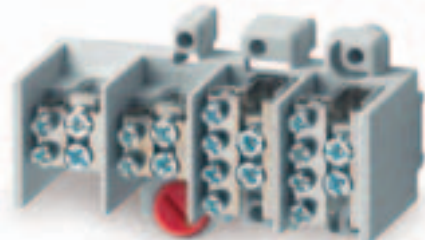

12647

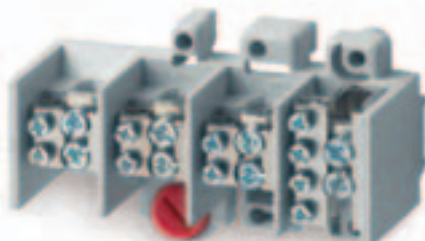

12637

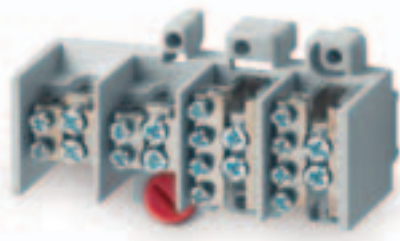

12687

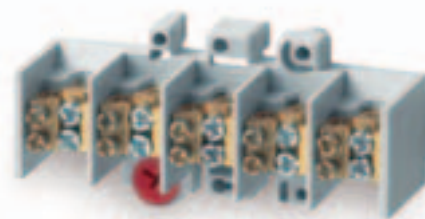

12657

Terminales con bornes

Sección nominal de 25 mm², 500 V.

Puntos de contacto según VDE 0603-2, tipo A.

Unidad de montaje universal rápido en horizontal y vertical para raíles de montaje de 35 mm. según EN 50022.

Estructura aislante de poliamida resistente al roce.

Color: gris RAL 7035.

Contactos de MS 58, tornillos de contacto de acero cincado con cabeza de tornillo en cruz con combinación pozidrive.

| Ref. | Nº de polos | Tipo / Sección mm ² | Peso en Kg 100 pcs. |  |
|-------|-------------|---|---------------------|---|
| 12597 | 2 | 1 Salida 16 mm ² por polo | 7,75 | 2/50 |
| 12587 | 3 | 1 Salida 16 mm ² por polo | 12,36 | 2/50 |
| 12647 | 4 | 1 Salida 16 mm ² por polo | 15,05 | 1/25 |
| 12637 | 4 | 3 polos con 1 Salida 16 mm ² 1 polo con 2 Salidas 16 mm ² | 16,30 | 1/25 |
| 12687 | 4 | 2 polos con 1 Salida 16 mm ² 2 polos con 2 Salidas 16 mm ² | 17,50 | 1/25 |
| 12657 | 5 | 1 Salida 16 mm ² por polo | 18,10 | 1/25 |

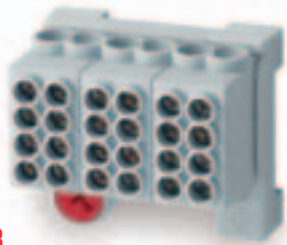

12538



12548

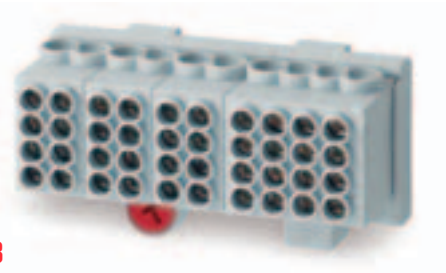

12358

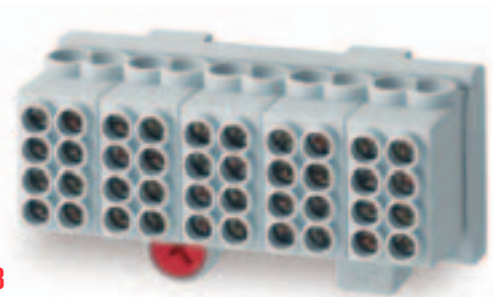

12558

Terminales de derivación de red de hasta 25 mm².

Con sistema de seguridad para el usuario según BGV A2



Sección nominal de 25 mm², 400 V. según VDE 0603-2, tipo C.

Unidad de montaje universal rápido en horizontal y vertical para raíles de montaje de 35 mm. según EN 50022.

Estructura aislante de poliamida resistente al roce.

Color: gris RAL 7035.

Contactos de MS 58, tornillos de contacto de acero cincado con cabeza de tornillo en cruz con combinación pozidrive.

| Ref. | | Nº de polos | Tipo / Sección mm ² | Peso en Kg 100 pcs. |  |
|-------|---|-------------|---|---------------------|---|
| 12538 |  | 3 | 4 Puntos de contacto 1,5 - 25 mm ² por polo | 19,15 | 2/50 |
| 12548 |  | 4 | 4 Puntos de contacto 1,5 - 25 mm ² por polo | 25,40 | 2/50 |
| 12358 |  | 4 | 3 polos con 4 Puntos de contacto 1,5 - 25 mm ² 1 polo con 8 Puntos de contacto 1,5 - 25 mm ² | 34,20 | 1/25 |
| 12558 |  | 5 | 4 Puntos de contacto 1,5 - 25 mm ² por polo | 31,50 | 1/25 |





125100



125200



125300



125400



125500

Terminales de derivación de red de 25 mm²., con sistema de seguridad para el usuario según BGV A2, con acoplamiento de sujeción.

Sección nominal de 25 mm²., 400 V, autorizado según VDE 0603-2, tipo C. Unidad de montaje rápido universal para montaje horizontal y vertical, para raíles de montaje de 35 mm. según EN 50022 (artículo n° 125100 solo para montaje horizontal).

Estructura aislante fabricada de poliamida altamente resistente al roce.

Color: Gris RAL 7035.

Contactos de M5 58, tornillos de contacto fabricados de acero cincado, con cabezal en cruz combinación pozidrive.

| Ref. | Nº de polos | Tipo / Sección mm ² | Peso en Kg 100 pcs. |  |
|--------|---|---|---------------------|---|
| 125100 |  1 | 4 Puntos de contacto 2,5 – 25 mm ² por polo | 6,00 | 2/50 |
| 125200 |  2 | 4 Puntos de contacto 2,5 – 25 mm ² por polo | 11,80 | 2/50 |
| 125300 |  3 | 4 Puntos de contacto 2,5 – 25 mm ² por polo | 17,50 | 2/50 |
| 125400 |  4 | 4 Puntos de contacto 2,5 – 25 mm ² por polo | 23,30 | 2/50 |
| 125500 |  5 | 5 Puntos de contacto 2,5 – 25 mm ² por polo | 29,00 | 2/50 |

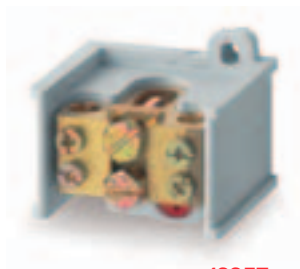

12257



12267

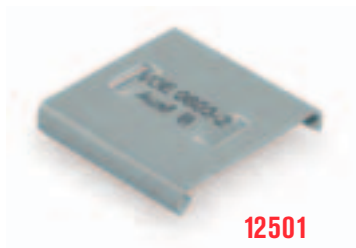

12501

Terminales de derivación de red de 70 mm²

Sección nominal de 70 mm², 500 V.

Unidad de montaje rápido para raíles de montaje de 35 mm. según DIN 46277 para sujeción con tornillos en superficies uniformes.

Estructura aislante fabricada en poliamida altamente resistente al roce.

Color: Gris RAL 7035.

Contactos de M5 58, tornillos de contacto de acero cincado con cabezal en cruz con combinación pozidrive.

| Ref. | Nº de polos | Tipo / Sección mm ² | Peso en Kg 100 pcs. |  |
|--------------|-------------|---------------------------------|---------------------|---|
| 12257 | 1 | 2 Salidas 50 mm ² | 42,80 | 2/20 |
| 12267 | 1 | 4 Salidas 50 mm ² | 44,70 | 2/20 |

Cubiertas de protección contra contactos

Material: PVC rígido color RAL 7030.

Para acoplar a terminales de derivación de red, para uso según VDE 0603-2 tipo B.

| Ref. | Para artículo | Peso en Kg 100 pcs. |  |
|--|---|---------------------|---|
| Para terminales de derivación de red de 25 mm ² . | | | |
| 12501 | 12317, 12517 | 0,35 | |
| 12502 | 12327, 12527, 12572, 123171, 123172, 125272 | 0,62 | |
| 12503 | 12337, 12537 | 0,87 | |
| 12504 | 12387, 12397, 12547 | 1,17 | |
| 12505 | 12357, 12367, 12377, 12557, 12567, 12577 | 1,45 | |

Para terminales de derivación de red de 35 mm².

| | | |
|--------------|---------------------|------|
| 12801 | 12707, 12717 | 0,40 |
| 12802 | 12727, 12737, 12767 | 0,78 |
| 12804 | 12747, 12777, 12847 | 1,39 |
| 12805 | 12757, 12787, 12797 | 1,70 |



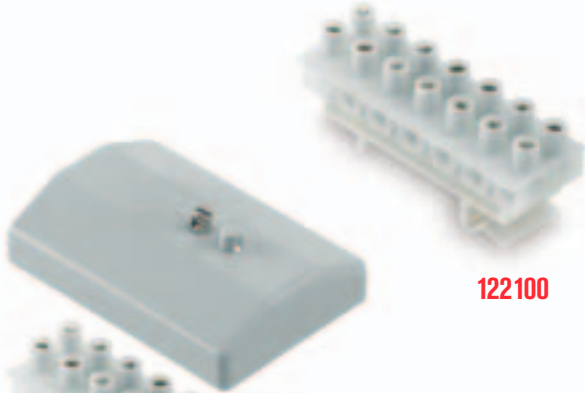

122100



122102



122300



122302

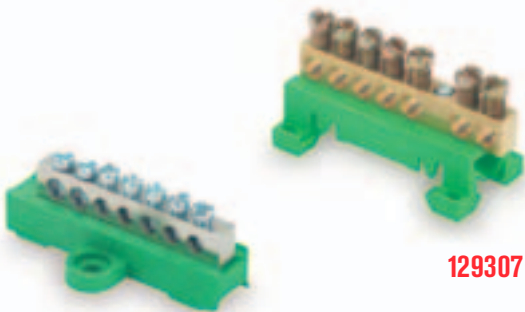

12901



129307



125160

Terminales de línea de control

7 polos, hasta 6 mm².

Accesorio de acoplamiento universal, montaje vertical sobre raíles de montaje de 35 mm.

Terminales numerados en la estructura.

| Ref. | Nº de polos | Tipo / Sección mm ² | Peso en Kg 100 pcs. | |
|--------|-------------|--------------------------------|---------------------|-----|
| 122100 | 7 | 4 x 2,5 mm ² | 3,40 | 100 |

Terminales de línea de control 127100 con cubierta adecuada para juntas de plomo.

| | | | | |
|--------|---|-------------------------|------|-----|
| 122102 | 7 | 4 x 2,5 mm ² | 4,50 | 100 |
|--------|---|-------------------------|------|-----|

| | | | | |
|--------|---|------------------------|------|-----|
| 122300 | 7 | 4 x 25 mm ² | 3,50 | 100 |
|--------|---|------------------------|------|-----|

Terminales de línea de control para montaje horizontal y vertical.

Línea de control 122300 con cubierta adecuada para juntas de plomo.

| | | | | |
|--------|---|------------------------|------|-----|
| 122302 | 7 | 4 x 25 mm ² | 4,60 | 100 |
|--------|---|------------------------|------|-----|

Terminales para cable a tierra

Sobre una base de plástico, poliamida verde/amarilla.

Montaje de acoplamiento para montaje vertical sobre un raíl de montaje.

| Ref. | Puntos de contacto | Tipo / Sección mm ² | Peso en Kg 100 pcs. | |
|--------|--------------------|--------------------------------|---------------------|-----|
| 129307 | 7 | 7 x 16 mm ² | 2,55 | 100 |
| 129312 | 12 | 12 x 16 mm ² | 4,37 | 100 |
| 129315 | 15 | 15 x 16 mm ² | 5,46 | 100 |

Terminales con cable conectado a tierra con pata de sujeción en la base de plástico para un montaje directo sobre una superficie uniforme con tornillos de diámetro hasta 4 mm.

| | | | | |
|-------|---|--|------|-----|
| 12901 | 7 | 2 x 16 mm ² + 5 x 10 mm ² | 3,00 | 200 |
|-------|---|--|------|-----|

Terminales con cable conectado a tierra con sistema de montaje rápido universal solo horizontal para raíles de montaje de 35 mm. según EN 50022.

| | | | | |
|--------|---|------------------------------|------|-----|
| 125160 | 4 | 4 x 2,5 - 25 mm ² | 6,00 | 100 |
|--------|---|------------------------------|------|-----|

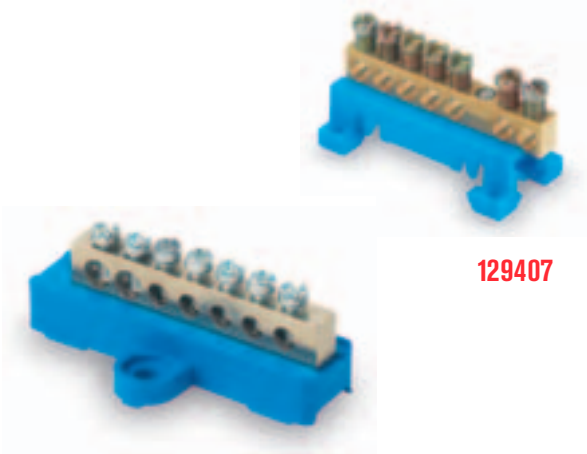

129407

12911



125170



12902



125267

Terminales para cable neutro

Colocados sobre de una base de plástico en poliamida azul.
Montaje con sujeción vertical para raíl de montaje.

| Ref. | Puntos de contacto | Tipo / Sección mm ² | Peso en Kg 100 pcs. | |
|---------------|--------------------|--------------------------------|---------------------|-----|
| 129407 | 7 | 7 x 16 mm ² | 2,55 | 100 |
| 129412 | 12 | 12 x 16 mm ² | 4,37 | 100 |
| 129415 | 15 | 15 x 16 mm ² | 5,46 | 100 |

Terminales con cable neutro con pata de sujeción en la base de plástico para montarlo directamente sobre una superficie plana con tornillos de hasta 4 mm. diámetro.

| | | | | |
|--------------|---|--|------|-----|
| 12911 | 7 | 2 x 16 mm ² + 5 x 10 mm ² | 3,00 | 200 |
|--------------|---|--|------|-----|

Terminales con cable neutro con sistema de montaje rápido universal (solo horizontal) para raíles de montaje de 35 mm. según EN 50022.

| | | | | |
|---------------|---|------------------------------|------|-----|
| 125170 | 4 | 4 x 2,5 - 25 mm ² | 6,00 | 100 |
|---------------|---|------------------------------|------|-----|

Contactos

Para terminales con cable conectado a tierra y neutro, con orificio de colocación trasero con diámetro de 3 mm.

| Ref. | Puntos de contacto | Tipo / Sección mm ² | Peso en Kg 100 pcs. | |
|--------------|--------------------|--|---------------------|-----|
| 12902 | 7 | 2 x 16 mm ² + 5 x 10 mm ² | 3,00 | 100 |

Terminales NPE

Sección transversal nominal de 25 mm²., 400 V, autorizada según VDE 0603-2, tipo C.

Para acoplarse sobre el raíl de montaje de 35 mm². según EN 50022.

Colores:

| Ref. | Puntos de contacto | Tipo / Sección mm ² | Peso en Kg 100 pcs. | |
|---------------|--------------------|--|---------------------|------|
| 125267 | 1 | 4 x 2,5 - 25 mm ² por polo | 11,80 | 2/50 |



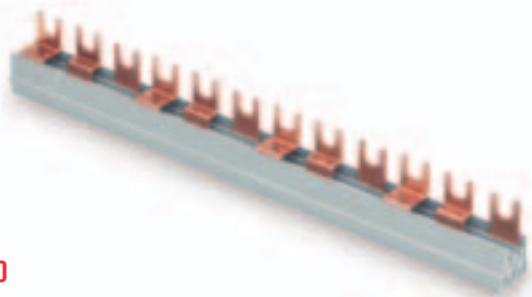

0900

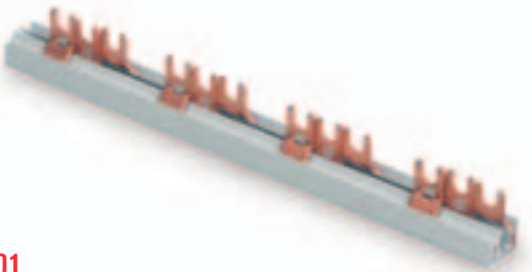

09001

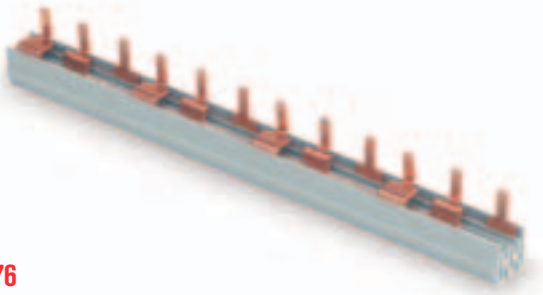

0976



0990

Bloques de barras de conexión

Sistema de tres cables adecuado para la conexión de disyuntores de seguridad, etc.
Material: Cobre.

| Ref. | Agujeros tipo | Espaciado en mm ² | Largo en mm. | Peso en Kg 100 pcs. |  |
|--------------|----------------|------------------------------|--------------|---------------------|---|
| 0900 | 10 / Horquilla | 17,8 | 210 | 9,90 | 25 |
| 0901 | 10 / Horquilla | 17,8 | 1000 | 51,20 | 20 |
| 0974 | 16 / Horquilla | 17,8 | 210 | 11,70 | 25 |
| 0975 | 16 / Horquilla | 17,8 | 1000 | 65,70 | 20 |
| 09001 | 10 / Horquilla | 17,8 | 210 | 8,50 | 25 |
| 09011 | 10 / Horquilla | 17,8 | 1000 | 43,80 | 20 |
| 0976 | 10 / Pin | 17,8 | 210 | 8,60 | 25 |
| 0977 | 10 / Pin | 17,8 | 1000 | 46,20 | 20 |
| 0978 | 16 / Pin | 17,8 | 210 | 11,50 | 25 |
| 0979 | 16 / Pin | 17,8 | 1000 | 53,40 | 20 |

Bloques de barras de conexiones para la conexión de elementos neozed.

| | | | | | |
|-------------|----------------|------|------|-------|----|
| 0902 | 10 / Horquilla | 27,0 | 1000 | 51,20 | 20 |
| 0981 | 16 / Horquilla | 27,0 | 1000 | 65,70 | 20 |
| 0986 | 16 / Pin | 27,0 | 1000 | 53,40 | 20 |

Tapa de extremo universal

Para bloques de barras de conexión de 10 y 16 mm².

| Ref. | Peso en Kg 100 pcs. |  |
|-------------|---------------------|---|
| 0990 | 0,06 | 10 |

Barras de bus – sistemas de línea única



Material: cobre.



0905

| Ref. | Agujeros tipo | Espaciado en mm ² | Largo en mm. | Peso en Kg 100 pcs. |  |
|--|----------------|------------------------------|--------------|---------------------|---|
| Adecuadas para la conexión de 12 disyuntores de seguridad. | | | | | |
| 0905 | 12 / Horquilla | 17,8 | 206 | 1,80 | 100 |
| 0906 | 12 / Horquilla | 17,8 | 1000 | 8,80 | 100 |
| 0907 | 24 / Horquilla | 17,8 | 1000 | 16,60 | 50 |
| Adecuadas para la conexión de elementos neozed. | | | | | |
| 0909 | 24 / Horquilla | 27,0 | 1000 | 18,60 | 50 |
| Tipo angular, aislado. | | | | | |
| 0956 | 10 / Horquilla | 17,8 | 210 | 3,90 | 100 |
| 0957 | 10 / Horquilla | 17,8 | 1000 | 18,40 | 50 |
| Tipo angular, aislado. | | | | | |
| 0959 | 10 / Pin | 17,8 | 210 | 3,30 | 100 |
| 0960 | 10 / Pin | 17,8 | 1000 | 16,90 | 50 |



0956



0959



09051

Raíl de bus universal

1 polo.

Para la conexión de disyuntores de seguridad, etc.

Material: cobre.

| Ref. | Agujeros tipo | Espaciado en mm ² | Largo en mm. | Peso en Kg 100 pcs. | |
|--------------|--|------------------------------|--------------|---------------------|----|
| | para la conexión de 12 disyuntores de seguridad | | | | |
| 09051 | 10 / Horquilla | 9,0 | 210 | 1,51 | 10 |
| | y 56 dispositivos de seguridad (anchura 17.5 mm.). | | | | |
| 09061 | 10 / Horquilla | 9,0 | 210 | 7,00 | 10 |



0914



0915

Terminales de conexión

Terminales aislados.

Material: Latón niquelado.

| Ref. | Agujeros tipo | Espaciado en mm ² | Largo en mm. | Peso en Kg 100 pcs. | |
|-------------|--------------------------------|------------------------------|--------------|---------------------|----|
| 0914 | 25 mm ² 7,0 mm Ø | | | 1,02 | 30 |
| 0915 | 25 mm ² 7,0 mm Ø | | | 1,2 | 30 |



0940



0942

Terminales de estribo

Para raíles de bus de 12 x 5 mm.

| Ref. | Agujeros tipo | Espaciado en mm ² | Largo en mm. | Peso en Kg 100 pcs. | |
|-------------|---------------|------------------------------|--------------|---------------------|----|
| 0940 | 16 | | | 1,65 | 40 |
| 0941 | 35 | | | 3,50 | 40 |
| 0942 | 50 | | | 4,50 | 40 |
| 0943 | 70-95 | | | 5,50 | 40 |



0925



0930



0920

Conexiones con terminal

Con terminal horquilla en los dos extremos.

| Ref. | Sección mm ² | Largo en mm. | Peso en Kg 100 pcs. |  |
|-------------|-------------------------|--------------|---------------------|---|
| 0925 | 6 | 125 | 0,87 | 50/1000 |
| 0926 | 6 | 250 | 1,78 | 50/500 |
| 0923 | 6 | 350 | 2,42 | 50/200 |
| 0927 | 10 | 125 | 1,48 | 25/500 |
| 0928 | 10 | 260 | 3,00 | 25/250 |
| 0929 | 10 | 350 | 4,06 | 25/200 |

Conexiones con terminal

Con terminales puntera en los dos extremos.

| Ref. | Sección mm ² | Largo en mm. | Peso en Kg 100 pcs. |  |
|-------------|-------------------------|--------------|---------------------|---|
| 0930 | 6 | 125 | 0,87 | 50/1000 |
| 0931 | 6 | 250 | 1,78 | 50/500 |
| 0932 | 6 | 350 | 2,52 | 50/200 |
| 0933 | 10 | 125 | 1,51 | 25/500 |
| 0934 | 10 | 260 | 3,00 | 25/250 |
| 0935 | 10 | 350 | 3,89 | 25/200 |

Conexiones con terminal

Con terminal puntera en un extremo y terminal horquilla en el otro extremo.

| Ref. | Sección mm ² | Largo en mm. | Peso en Kg 100 pcs. |  |
|-------------|-------------------------|--------------|---------------------|---|
| 0920 | 6 | 125 | 0,87 | 50/1000 |
| 0921 | 6 | 250 | 1,78 | 50/500 |
| 0922 | 6 | 350 | 2,38 | 50/200 |
| 0936 | 10 | 125 | 1,44 | 25/500 |
| 0937 | 10 | 260 | 2,88 | 25/250 |
| 0938 | 10 | 350 | 4,09 | 25/200 |



¿Sabía qué...

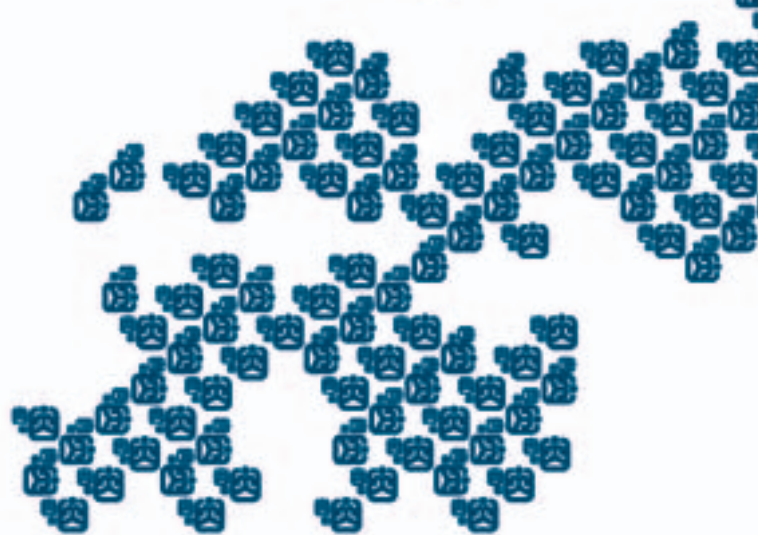

2005



1985



...X.B. components, s.a. celebra en 2005 su 20 aniversario?

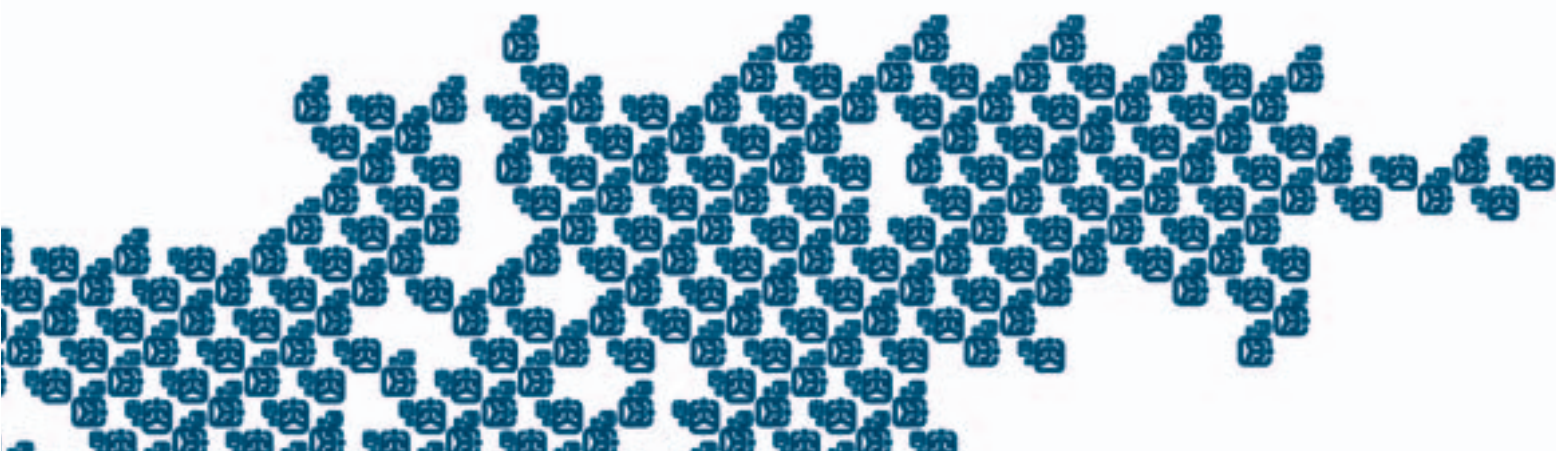



SERIE
BOXLINE



BOXDIN

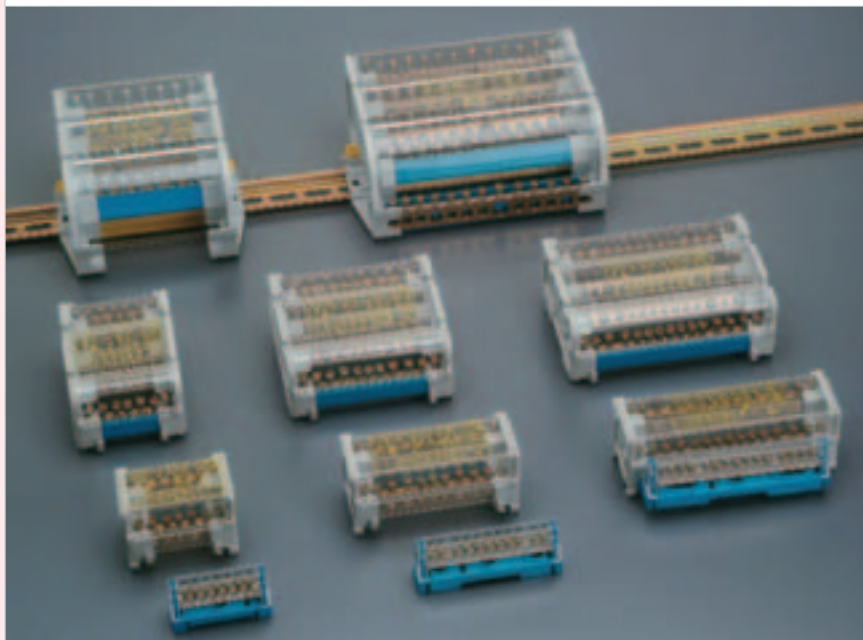

Conjuntos repartidores con conexiones de latón, tornillos de acero, soporte de poliamida y tapa de policarbonato. Fijación a carril Din o a panel. Según norma CEI EN 60947-1.

| Ref. | A. | Nº de orificios por barra | | | | | | | | |
|--------------------|------------------|---------------------------|-----|-----|-------|-----|-----|------|-----|------|
| | | Ø 5,3 | Ø 6 | Ø 7 | Ø 7,5 | Ø 8 | Ø 9 | Ø 12 | | |
| BIPOLAR | BD-5072 | 50 | 5 | 2 | | | | | | 4-48 |
| | BD-50112 | 50 | 9 | 2 | | | | | | 4-48 |
| | BD-50152 | 50 | 13 | 2 | | | | | | 4-48 |
| | BD-10072 | 100 | | 5 | | 2 | | | | 4-40 |
| | BD-125112 | 125 | | 7 | | 2 | | 2 | | 2-20 |
| | BD-125152 | 125 | | 11 | | 2 | | 2 | | 2-20 |
| TETRAPOLAR | BD-5074 | 50 | 5 | 2 | | | | | | 4-48 |
| | BD-50114 | 50 | 9 | 2 | | | | | | 2-24 |
| | BD-50154 | 50 | 13 | 2 | | | | | | 2-24 |
| | BD-10074 | 100 | | 5 | | 2 | | | | 2-20 |
| | BD-125114 | 125 | | 7 | | 2 | | 2 | | 1-10 |
| | BD-125154 | 125 | | 11 | | 2 | | 2 | | 1-10 |
| | BD-16084 | 160 | | | 5 | | 1 | 1 | 1 | 1-12 |
| BD-160134 | 160 | | | 8 | | 2 | 2 | 1 | 1-6 | |
| PENTA-POLAR | BD-16085 | 160 | | | 5 | | 1 | 1 | 1 | 1-12 |
| | BD-160135 | 160 | | | 8 | | 2 | 2 | 1 | 1-6 |

Barras protegidas, en colores azul y gris, para utilización individual, o montaje de repartidores de 50 A. mediante soportes referencia 160SM-2 ó 160SM-4

| Ref. | A. | Nº de orificios por barra | | | |
|----------------|---------------|---------------------------------------|-----|------|--------|
| | | Ø 5,3 | Ø 6 | | |
| 507-F | 507-N | 50 | 5 | 2 | 20-240 |
| 5011-F | 5011-N | 50 | 9 | 2 | 12-144 |
| 5015-F | 5015-N | 50 | 13 | 2 | 10-120 |
| 160SM-2 | | Soporte bipolar (dos elementos) | | 6-72 | |
| 160SM-4 | | Soporte tetrapolar (cuatro elementos) | | 6-72 | |

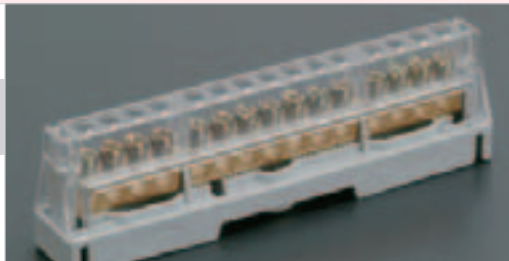



BOXLINE

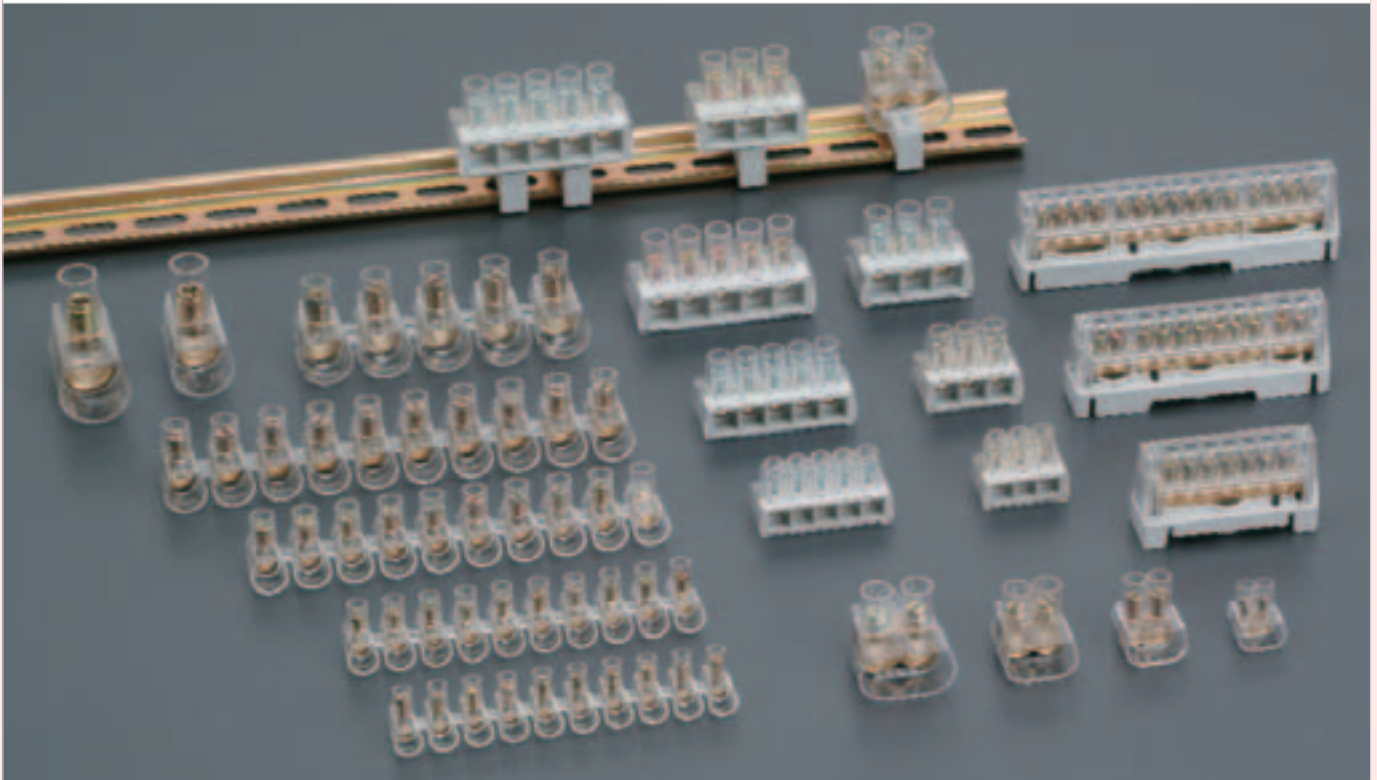

Regletas de conexión unipolares de latón, con tornillos de acero cincado y aislamiento de policarbonato transparente y autoextinguible. Resistencia al calentamiento + 130°. Según norma CEI EN 60998-1-1995 CEI 23-21 II Ed. 1992.

| Ref. | Sección mm ² | | Ref. | Sección mm ² | |
|-----------------|-------------------------|-------------------|-----------|-------------------------|--------------------------------|
| XB-25 | 2,50 mm. | Tiras de 10 polos | 25-450 | XB-42 | 4,00 mm. 1 polo, 2 conexiones |
| XB-40 | 4,00 mm. | Tiras de 10 polos | 25-450 | XB-62 | 6,00 mm. 1 polo, 2 conexiones |
| XB-60 | 6,00 mm. | Tiras de 10 polos | 25-450 | XB-102 | 10,00 mm. 1 polo, 2 conexiones |
| XB-100 | 10,00 mm. | Tiras de 10 polos | 10-300 | XB-162 | 16,00 mm. 1 polo, 2 conexiones |
| XB-160 | 16,00 mm. | Tiras de 5 polos | 10-240 | XB-63 | 6,00 mm. 1 polo, 3 conexiones |
| XB-25-1 | 2,50 mm. | 1 polo | 1000-8000 | XB-163 | 16,00 mm. 1 polo, 3 conexiones |
| XB-40-1 | 4,00 mm. | 1 polo | 800-6400 | XB-253 | 25,00 mm. 1 polo, 3 conexiones |
| XB-60-1 | 6,00 mm. | 1 polo | 500-4000 | XB-65 | 6,00 mm. 1 polo, 5 conexiones |
| XB-100-1 | 10,00 mm. | 1 polo | 300-2400 | XB-165 | 16,00 mm. 1 polo, 5 conexiones |
| XB-160-1 | 16,00 mm. | 1 polo | 10-300 | XB-255 | 25,00 mm. 1 polo, 5 conexiones |
| XB-250 | 25,00 mm. | 1 polo | 5-150 | | |
| XB-350 | 35,00 mm. | 1 polo | 5-150 | | |

ACCESORIOS PARA REGLETAS BOXLINE DE 2, 3 Y 5 ORIFICIOS

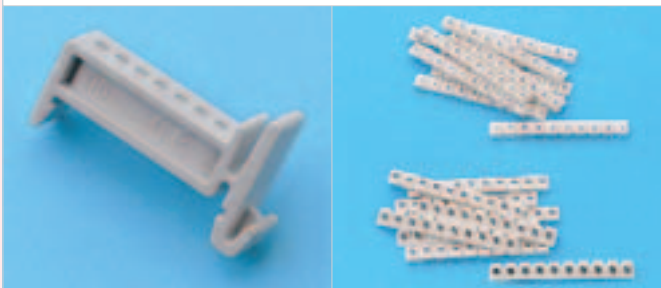

| Ref. | | |
|---------------|-----------------------------------|--------|
| 159-SM | Soporte de fijación para guía DIN | 10-40 |
| BEZ... | Señalizadores | 10-100 |



EQUIJOINT

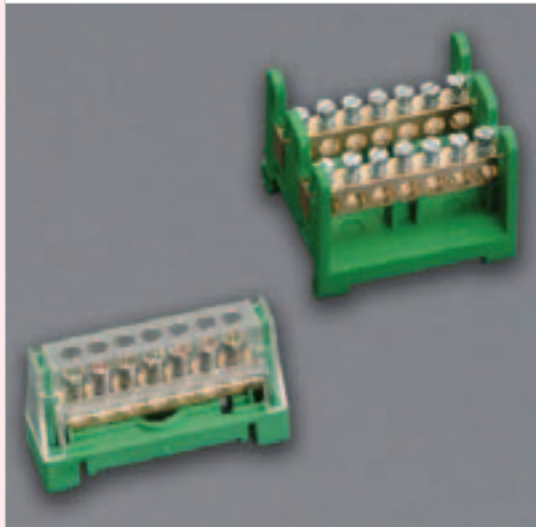

Regletas equipotenciales para la derivación de tomas de tierra. Soportes en color verde. Fijación a panel o sobre guía Din.

| Ref. | Barras | | | |
|----------------|--------|--------------------------------------|--------------|------|
| XB-167 | 1x7 | 7 Orificios de 6 mm. | montaje | 2-32 |
| XB-1614 | 2x7 | 14 Orificios de 6 mm. | horizontal | 2-32 |
| XB-1628 | 2x14 | 24 Orificios de 6 mm. y 4 de 7,5 mm. | s/. Guía Din | 1-16 |

Las referencias siguientes, pueden acoplarse a los repartidores BOXDIN de 100 A. y 125 A., para ampliación de neutros o tomas de tierra.

| | | | | |
|---------------|------|--------------------------------------|--------------|--------|
| T-167 | 1x7 | 5 Orificios de 5,3 mm. y 2 de 6 mm. | montaje | 20-240 |
| T-1611 | 1x11 | 9 Orificios de 5,3 mm. y 2 de 6 mm. | vertical | 12-144 |
| T-1615 | 1x15 | 13 Orificios de 5,3 mm. y 2 de 6 mm. | s/. Guía Din | 10-120 |

BOXBARRA

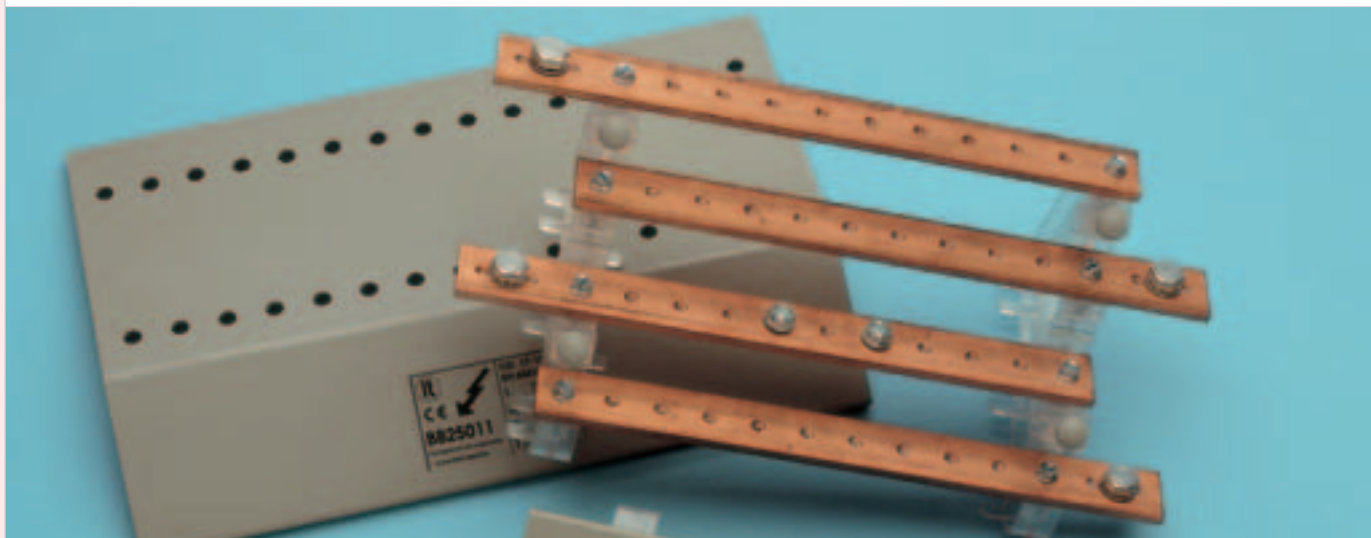

Repartidores tetrapolares con pletina roscada, salidas con terminal ó pletina flexible y fijación a guía Din ó directo sobre panel. Según norma CEI-17-13/1 EN60439-1.

| Ref. | A. | Pletina | Orificios | Medidas | | Ref. | A. | Pletina | Orificios | Medidas | |
|------------------------------------|-----|---------|------------|------------|-----|--|-----|---------|------------|-------------|-----|
| BBD-1256 | 125 | 12x4 | 6 M5 | 183x135x74 | 2-8 | SALIDAS PARA PLETINA Y TERMINAL Y FIJACIÓN A PANEL | | | | | |
| BBD-12511 | 125 | 12x4 | 11 M5 | 280x135x74 | 2-8 | BB-2506 | 250 | 20x5 | 5 M6+1 M8 | 202x175x110 | 2-8 |
| BBD-12517 | 125 | 12x4 | 17 M5 | 410x135x74 | 1-4 | BB-25011 | 250 | 20x5 | 10 M6+1 M8 | 299x175x110 | 2-8 |
| BBD-12527 | 125 | 12x4 | 27 M5 | 620x135x74 | 1-4 | BB-25017 | 250 | 20x5 | 16 M6+1 M8 | 410x175x110 | 1-4 |
| BBD-1606 | 160 | 15x4 | 6 M5 | 183x135x74 | 2-8 | BB-25027 | 250 | 20x5 | 26 M6+1 M8 | 620x175x110 | 1-4 |
| BBD-16011 | 160 | 15x4 | 11 M5 | 280x135x74 | 2-8 | BB-4006 | 400 | 25x6 | 5 M6+1 M8 | 202x175x110 | 2-8 |
| BBD-16017 | 160 | 15x4 | 17 M5 | 410x135x74 | 1-4 | BB-40011 | 400 | 25x6 | 10 M6+1 M8 | 299x175x110 | 2-8 |
| BBD-16027 | 160 | 15x4 | 27 M5 | 620x135x74 | 1-4 | BB-40017 | 400 | 25x6 | 16 M6+1 M8 | 410x175x110 | 1-4 |
| SALIDAS SÓLO PARA PLETINA FLEXIBLE | | | | | | BB-40027 | 400 | 25x6 | 26 M6+1 M8 | 620x175x110 | 1-4 |
| BBD-2506 | 250 | 16x6 | 5 M6+1 M8 | 183x135x74 | 2-8 | | | | | | |
| BBD-25011 | 250 | 16x6 | 10 M6+1 M8 | 280x135x74 | 2-8 | | | | | | |
| BBD-25017 | 250 | 16x6 | 16 M6+1 M8 | 410x135x74 | 1-4 | | | | | | |
| BBD-25027 | 250 | 16x6 | 26 M6+1 M8 | 620x135x74 | 1-4 | | | | | | |



BOXKANAL. CONECTOR DE DERIVACIÓN AISLADO PARA CANALETA Y BANDEJA

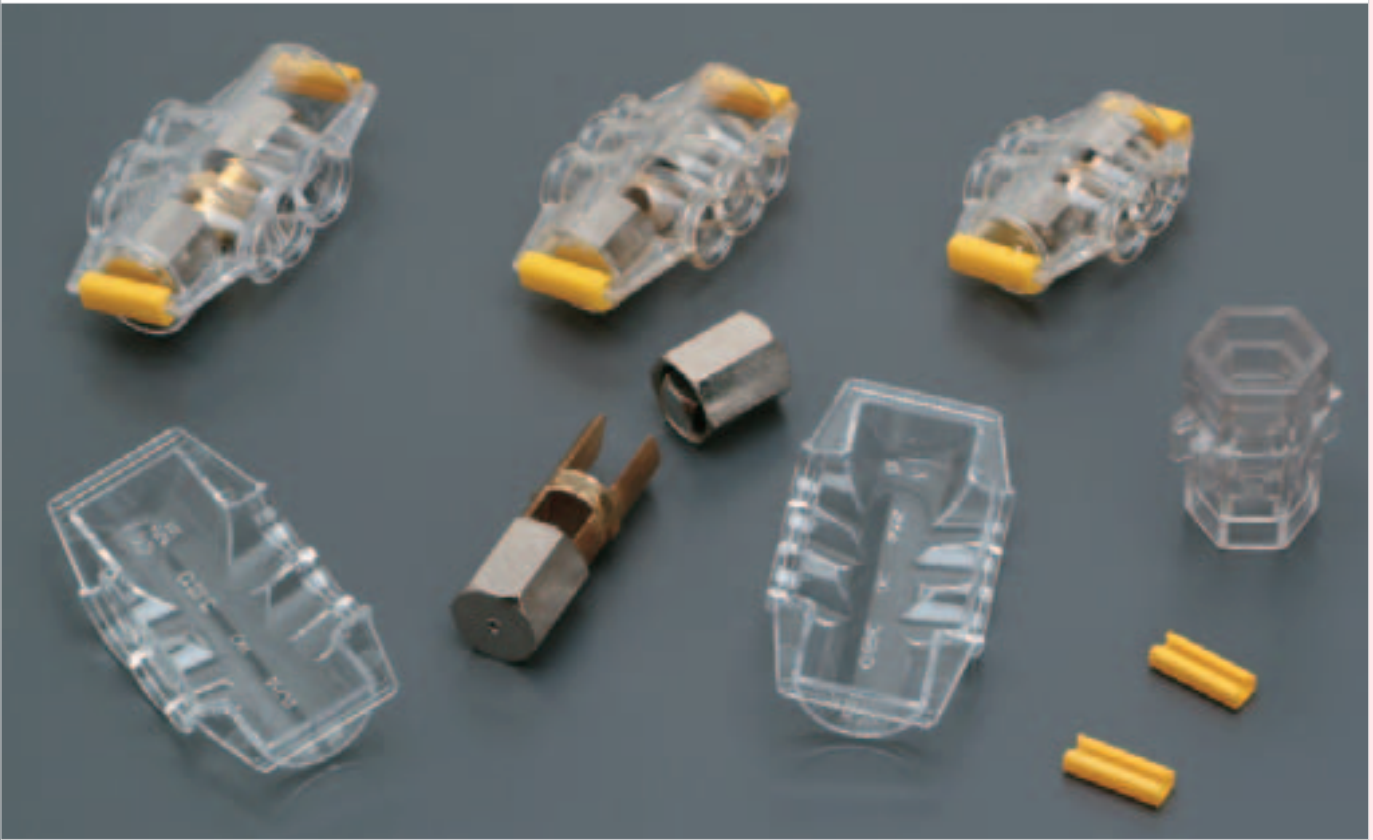

Facilita la conexión en cualquier punto mediante el pelado del cable principal sin necesidad de cortes. Garantiza una mayor continuidad y evita caídas de tensión. Posibilita la conexión de cables con doble aislamiento.

Cuerpo aislante: Policarbonato transparente.

Cuerpo de conexión: Latón.

Conexión: Indirecto mediante tuercas de latón.

Material cuerpo aislante: Policarbonato transparente, autoextinguible (VO (UL-94)), antichoque.

Resistencia al calor: + 130°C.

Prueba del hilo incandescente: 960°C.

Conforme a las normas: CEI 23-20 II ED, CEI 23-21 II ED, IEC 998-1, IEC 998-2-1, CEI EN 60947-1.

| Ref. | Sección nominal mm ² | Sección cable mm ² | Nº de cables | | Nº salidas | Voltios | |
|---------------|---------------------------------|-------------------------------|--------------|----------|------------|---------|------|
| | | | rígido | flexible | | | |
| BK-616 | 2 x 16 | 16-16 | 1-1 | 1-1 | 6 | 500 | 2/60 |
| | | 16-10 | 1-1 | 1-1 | | | |
| | | 16-6 | 1-2 | 1-2 | | | |
| | | 16-4 | 1-4 | 1-4 | | | |
| BK-635 | 2 x 35 | 35-35 | 1-1 | 1-1 | 6 | 500 | 2/60 |
| | | 35-25 | 1-1 | 1-1 | | | |
| | | 35-16 | 1-2 | 1-2 | | | |
| | | 35-10 | 1-3 | 1-3 | | | |
| BK-650 | 2 x 50 | 50-50 | 1-1 | 1-1 | 6 | 500 | 2/40 |
| | | 50-35 | 1-1 | 1-1 | | | |
| | | 50-25 | 1-2 | 1-2 | | | |
| | | 50-16 | 1-3 | 1-3 | | | |
| BK-670 | 2 x 70 | 70-70 | 1-1 | 1-1 | 6 | 500 | 1/30 |
| | | 70-50 | 1-1 | 1-1 | | | |
| | | 70-35 | 1-2 | 1-2 | | | |
| | | 70-16 | 1-4 | 1-4 | | | |



ACCESORIOS. CAJAS DE CONEXIÓN PARA LUMINARIAS

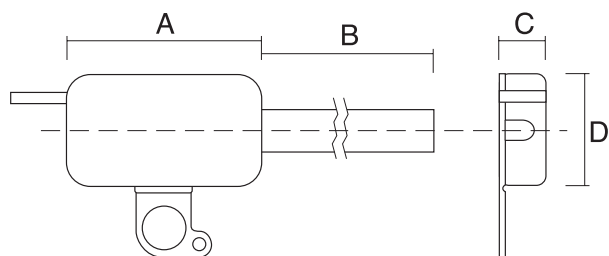
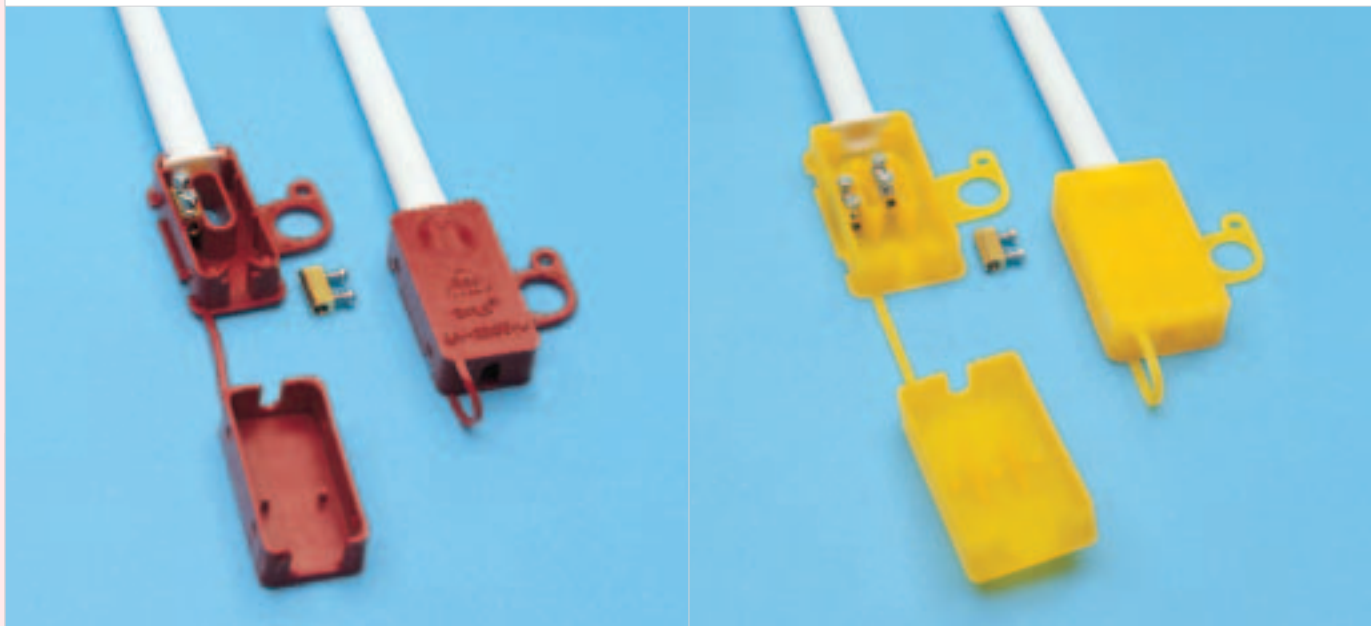

Resistencia al calentamiento: + 150°.
según norma CEI 34-21 IV ED.1994. (EN 60958-1-1993).

| Ref. | Polos | Sección | Dimensiones mm. | | | | |
|---------------|-------|----------------------|-----------------|----|------|------|---------|
| | | | A | B | C | D | |
| 215-RO | 2 | 1,50 mm ² | 38,0 | 72 | 11,5 | 19,5 | 25/2000 |
| 315-AM | 3 | 1,50 mm ² | 48,8 | 72 | 11,5 | 25,8 | 25/1000 |



SERIE XB FLEX

TUBOS PARA AISLAMIENTO ELÉCTRICO, TÉCNICO, PROTECCIÓN MECÁNICA,
AMORTIGUACIÓN DE RUIDOS, EXTENSIBLES, ADAPTABLES, ETC.



PERIFLEX

P-S



Trenzado extensible de monofilamento de **poliéster**. Duro resistente y ligero.
Muy buena resistencia a la abrasión.
 Temperatura de trabajo: -50 °C a + 150 °C. **Autoextinguible.**
 Buena resistencia química. **Libre de halógenos.**
 Ratio de expansión 1:2 aprox.
 Aplicación: protección mecánica y térmica de conductores eléctricos y otros componentes.

| Ref. ■ Negro | Ref. ■ Gris | Dimensiones en mm. | | | Rollo mts. |
|-------------------|-------------------|--------------------|---------|------|---------------|
| | | Mín. | Nominal | Máx. | |
| XBFX-03-NG | XBFX-03-GR | 2 | 3 | 5 | 100 |
| XBFX-04-NG | XBFX-04-GR | 3 | 4 | 7 | 100 |
| XBFX-05-NG | XBFX-05-GR | 4 | 5 | 9 | 100 |
| XBFX-06-NG | XBFX-06-GR | 5 | 6 | 10 | 100 |
| XBFX-08-NG | XBFX-08-GR | 6 | 8 | 14 | 100 |
| XBFX-10-NG | XBFX-10-GR | 8 | 10 | 16 | 100 |
| XBFX-12-NG | XBFX-12-GR | 10 | 12 | 21 | 50 |
| XBFX-15-NG | XBFX-15-GR | 12 | 15 | 22 | 50 |
| XBFX-20-NG | XBFX-20-GR | 15 | 20 | 27 | 25 |
| XBFX-25-NG | XBFX-25-GR | 20 | 25 | 34 | 25 |
| XBFX-30-NG | XBFX-30-GR | 25 | 30 | 45 | 25 |
| XBFX-40-NG | XBFX-40-GR | 35 | 40 | 60 | 25 |
| XBFX-50-NG | XBFX-50-GR | 45 | 50 | 73 | 25 |

5 Serie XBFLX



PERIFLEX

N-SG

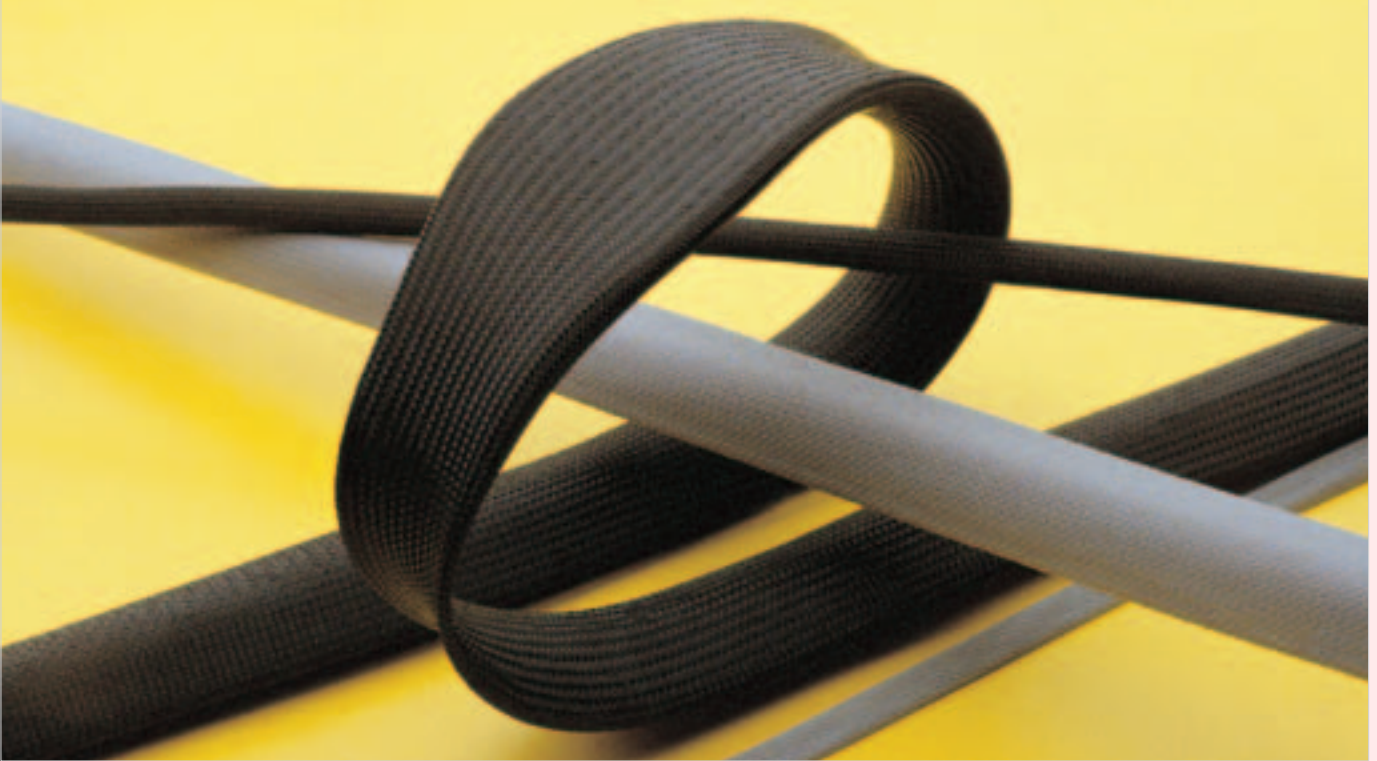

Trenzado extensible de monofilamento de **poliamida**. Duro resistente y ligero.

Excelente resistencia a la abrasión.

Temperatura de trabajo: -50 °C a + 150 °C.

Autoextinguible. Buena resistencia química.

Libre de halógenos. Ratio de expansión 1:2 aprox.

Aplicación: protección mecánica y térmica de conductores eléctricos y otros componentes.

| Ref. ■ Negro | Dimensiones en mm. | | | Rollo mts. |
|--------------------|--------------------|---------|------|---------------|
| | Mín. | Nominal | Máx. | |
| XBFX-04N-NG | 3 | 4 | 8,1 | 100 |
| XBFX-06N-NG | 4 | 6 | 9,5 | 100 |
| XBFX-08N-NG | 5 | 8 | 11,5 | 100 |
| XBFX-10N-NG | 7 | 10 | 14,5 | 100 |
| XBFX-12N-NG | 8 | 12 | 17,5 | 50 |
| XBFX-14N-NG | 10 | 14 | 20 | 50 |
| XBFX-16N-NG | 13 | 16 | 21 | 25 |
| XBFX-18N-NG | 14,5 | 18 | 23,5 | 25 |
| XBFX-20N-NG | 16 | 20 | 26,5 | 25 |
| XBFX-22N-NG | 17 | 22 | 34 | 25 |
| XBFX-25N-NG | 18 | 25 | 40 | 25 |
| XBFX-30N-NG | 26 | 30 | 40 | 25 |
| XBFX-40N-NG | 34 | 40 | 55 | 25 |
| XBFX-50N-NG | 45 | 50 | 60 | 25 |
| XBFX-70N-NG | 62 | 70 | 75 | 25 |

5 Serie XBFLX



PERIFLEX SELF CLOSING

PLAF 1



Manga abierta de tejido trenzado, fabricada en poliéster. Permite su utilización una vez terminado el proceso de cableado, ejerciendo un fuerte cierre sobre el mismo. Muy buena resistencia química, **reciclable, libre de halógenos, auto extingible, ultra flexible. Ratio de expansión: 1:1,5.**

Temperatura de trabajo: -50°C a +150°C. Color: ■ negro.

Aplicación: Protección mecánica y térmica de conductores eléctricos y otros componentes. **PLAF 1, es la versión mas flexible de la gama SELF CLOSING.** Especificaciones : IEC 60684 página 340 y UL 224.

| Ref. | Ratio de aplicación | | | Ancho mm. | Rollo mts. |
|-------------------|---------------------|--------------|--------------|-----------|------------|
| | Solapado 75% | Solapado 50% | Solapado 25% | | |
| PLAF1NE040 | 4 | 6 | 8 | 37 +/- 5 | 250 |
| PLAF1NE070 | 7 | 10 | 12 | 53 +/- 5 | 250 |
| PLAF1NE100 | 10 | 12 | 15 | 63 +/- 5 | 250 |
| PLAF1NE140 | 14 | 17 | 21 | 84 +/- 8 | 150 |
| PLAF1NE200 | 20 | 23 | 28 | 114 +/- 8 | 150 |
| PLAF1NE260 | 26 | 28 | 34 | 135 +/- 8 | 100 |
| PLAF1NE320 | 32 | 36 | 44 | 175 +/- 8 | 100 |

PLAS 7



Manga abierta de tejido trenzado, fabricada en poliéster. Permite su utilización una vez terminado el proceso de cableado, ejerciendo un fuerte cierre sobre el mismo. **Muy buena resistencia a la abrasión,** muy buena resistencia química, **reciclable, libre de halógenos, auto extingible, extra flexible. Ratio de expansión: 1:1,5.**

Temperatura de trabajo: -50°C a +150°C. Color: ■ negro.

Aplicación: Protección mecánica y térmica de conductores eléctricos y otros componentes. Especificaciones: IEC 60684 página 340 y UL 224.

| Ref. | Ratio de aplicación | | | Ancho mm. | Rollo mts. |
|-------------------|---------------------|--------------|--------------|-----------|------------|
| | Solapado 75% | Solapado 50% | Solapado 25% | | |
| PLAS7NE040 | 4 | 6 | 8 | 37 +/- 5 | 250 |
| PLAS7NE070 | 7 | 10 | 12 | 53 +/- 5 | 250 |
| PLAS7NE100 | 10 | 12 | 15 | 63 +/- 5 | 250 |
| PLAS7NE140 | 14 | 17 | 21 | 84 +/- 8 | 150 |
| PLAS7NE200 | 20 | 23 | 28 | 114 +/- 8 | 150 |
| PLAS7NE260 | 26 | 28 | 34 | 135 +/- 8 | 100 |
| PLAS7NE320 | 32 | 36 | 44 | 175 +/- 8 | 100 |



REVITEX

VSC-25



Tubo trenzado, de fibra de vidrio recubierto de caucho silicona.

Temperatura de trabajo: -70°C a +235°C, puntas de 300°C.

Rigidez dieléctrica según norma UL 1441: 4000V.

Muy flexible. Excelente resistencia a fluidos y agentes químicos agresivos.

Autoextinguible, VW-1. Libre de halógenos.

Aplicaciones: aislamiento térmico y eléctrico de cables sometidos a altas temperaturas.

Especificaciones: IEC 60684 página 400-402 y UL 1441.

| Ref. ■ Negro | Ref. ■ Rojo Teja | Ø mm. Nominal | Tolerancia + /- mm. | Espesor pared mm. | Rollos mts. |
|-----------------|---------------------|------------------|------------------------|-------------------------|----------------|
| VSC25NE005 | VSC25RT005 | 0,5 | 0,15 | 0,25 | 400 |
| VSC25NE010 | VSC25RT010 | 1,0 | 0,20 | 0,35 | 400 |
| VSC25NE015 | VSC25RT015 | 1,5 | 0,20 | 0,35 | 200 |
| VSC25NE020 | VSC25RT020 | 2,0 | 0,20 | 0,35 | 200 |
| VSC25NE025 | VSC25RT025 | 2,5 | 0,20 | 0,35 | 200 |
| VSC25NE030 | VSC25RT030 | 3,0 | 0,20 | 0,35 | 200 |
| VSC25NE035 | VSC25RT035 | 3,5 | 0,25 | 0,35 | 200 |
| VSC25NE040 | VSC25RT040 | 4,0 | 0,25 | 0,35 | 200 |
| VSC25NE045 | VSC25RT045 | 4,5 | 0,25 | 0,45 | 200 |
| VSC25NE050 | VSC25RT050 | 5,0 | 0,25 | 0,45 | 200 |
| VSC25NE060 | VSC25RT060 | 6,0 | 0,25 | 0,45 | 200 |
| VSC25NE070 | VSC25RT070 | 7,0 | 0,25 | 0,45 | 100 |
| VSC25NE080 | VSC25RT080 | 8,0 | 0,25 | 0,45 | 100 |
| VSC25NE090 | VSC25RT090 | 9,0 | 0,50 | 0,45 | 100 |
| VSC25NE100 | VSC25RT100 | 10,0 | 0,50 | 0,45 | 100 |
| VSC25NE120 | VSC25RT120 | 12,0 | 0,50 | 0,55 | 100 |
| VSC25NE140 | VSC25RT140 | 14,0 | 0,50 | 0,65 | 50 |
| VSC25NE160 | VSC25RT160 | 16,0 | 1,00 | 0,65 | 50 |

VSC75



Tubo trenzado, de fibra de vidrio recubierto de caucho silicona. **Temperatura de trabajo: -70°C a +235°C, puntas de 300°C.**

Rigidez dieléctrica según norma UL 1441: 8000V.

Muy flexible. Excelente resistencia a fluidos y agentes químicos agresivos.

Autoextinguible, VW-1. Libre de halógenos.

Aplicaciones: aislamiento térmico y eléctrico de cables sometidos a altas temperaturas. Especificaciones: IEC 60684 página 400-402 y UL 1441.

HOMOLOGACION: UL y cUL GRADO A 600V. 200°C.

Según archivo nº E 121222.

| Ref. ■ Negro | Ref. ■ Rojo Teja | Ø mm. Nominal | Tolerancia + /- mm. | Espesor pared mm. | Rollos mts. |
|-----------------|---------------------|------------------|------------------------|-------------------------|----------------|
| VSC75NE005 | VSC75RT005 | 0,5 | 0,18 | 0,28 | 200 |
| VSC75NE010 | VSC75RT010 | 1,0 | 0,25 | 0,38 | 200 |
| VSC75NE015 | VSC75RT015 | 1,5 | 0,25 | 0,38 | 200 |
| VSC75NE020 | VSC75RT020 | 2,0 | 0,25 | 0,38 | 200 |
| VSC75NE025 | VSC75RT025 | 2,5 | 0,25 | 0,46 | 200 |
| VSC75NE030 | VSC75RT030 | 3,0 | 0,30 | 0,46 | 200 |
| VSC75NE035 | VSC75RT035 | 3,5 | 0,30 | 0,46 | 200 |
| VSC75NE040 | VSC75RT040 | 4,0 | 0,40 | 0,51 | 200 |
| VSC75NE045 | VSC75RT045 | 4,5 | 0,50 | 0,51 | 200 |
| VSC75NE050 | VSC75RT050 | 5,0 | 0,50 | 0,51 | 100 |
| VSC75NE060 | VSC75RT060 | 6,0 | 0,50 | 0,51 | 100 |
| VSC75NE070 | VSC75RT070 | 7,0 | 0,50 | 0,51 | 100 |
| VSC75NE080 | VSC75RT080 | 8,0 | 0,60 | 0,64 | 100 |
| VSC75NE090 | VSC75RT090 | 9,0 | 0,60 | 0,64 | 100 |
| VSC75NE100 | VSC75RT100 | 10,0 | 0,60 | 0,64 | 100 |
| VSC75NE120 | VSC75RT120 | 12,0 | 0,60 | 0,64 | 100 |
| VSC75NE140 | VSC75RT140 | 14,0 | 0,70 | 0,64 | 50 |
| VSC75NE160 | VSC75RT160 | 16,0 | 0,70 | 0,64 | 50 |



REVITEX

VSX40

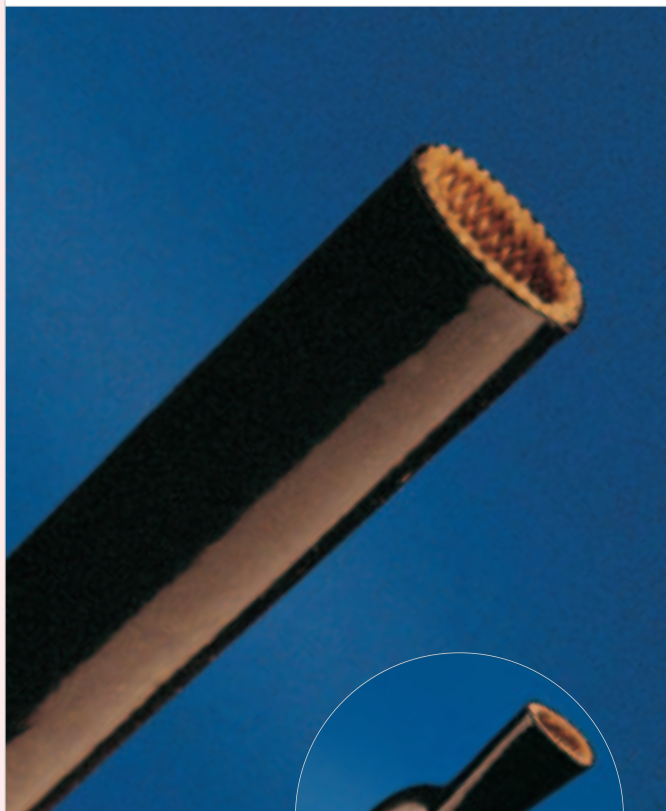

Tubo **expandible**, trenzado de fibra de vidrio, recubierto de caucho silicona.

Temperatura de trabajo: -70°C a +230°C puntas de 300°C.

Rigidez dieléctrica según norma UL 1441: 7000V. normal y 4000V. expandido. Su extraordinaria flexibilidad, le permite recuperar sus medidas iniciales después de la expansión, adaptándose así, perfectamente a formas irregulares.

Ratio de expansión: 1:1,6 aprox. Excelente resistencia a fluidos y agentes químicos agresivos. **Autoextinguible VW-1. Libre de halógenos.**

Aplicaciones: aislamiento térmico y eléctrico de cables y otros componentes, sometidos a altas temperaturas. Especificaciones: IEC 60684 y UL 1441

| Ref. | Ref. | Ø mm. | Tolerancia | Espesor | |
|-------------------|-------------------|---------|------------|---------|--------|
| ■ Negro | ■ Rojo Teja | Nominal | +/- mm. | pared | Rollos |
| | | | | mm. | mts. |
| VSX40NE020 | VSX40RT020 | 2,0 | 0,20 | 0,50 | 200 |
| VSX40NE030 | VSX40RT030 | 3,0 | 0,20 | 0,50 | 200 |
| VSX40NE040 | VSX40RT040 | 4,0 | 0,25 | 0,50 | 200 |
| VSX40NE060 | VSX40RT060 | 6,0 | 0,25 | 0,60 | 100 |
| VSX40NE080 | VSX40RT080 | 8,0 | 0,25 | 0,60 | 100 |
| VSX40NE100 | VSX40RT100 | 10,0 | 0,50 | 0,75 | 100 |
| VSX40NE120 | VSX40RT120 | 12,0 | 0,50 | 0,75 | 50 |
| VSX40NE140 | VSX40RT140 | 14,0 | 0,50 | 0,75 | 50 |
| VSX40NE160 | VSX40RT160 | 16,0 | 1,00 | 0,75 | 50 |

VSX75



Tubo **expandible**, trenzado de fibra de vidrio, recubierto de caucho silicona.

Temperatura de trabajo: -70°C a +230°C puntas de 300°C.

Rigidez dieléctrica según norma UL 1441: 9000V. normal y 8500V. expandido. Su extraordinaria flexibilidad, le permite recuperar sus medidas iniciales después de la expansión, adaptándose así, perfectamente a formas irregulares.

Ratio de expansión: 1:2 aprox. Excelente resistencia a fluidos y agentes químicos agresivos. **Autoextinguible VW-1. Libre de halógenos.** Aplicaciones:

aislamiento térmico y eléctrico de cables y otros componentes, sometidos a altas temperaturas. Especificaciones: UL 1441. **HOMOLOGACION: UL y cUL, GRADO A, 600V. 200°C. Según archivo nº E 121222.**

| Ref. | Ref. | Ø mm. | Tolerancia | Espesor | |
|-------------------|-------------------|---------|------------|---------|--------|
| ■ Negro | ■ Rojo Teja | Nominal | +/- mm. | pared | Rollos |
| | | | | mm. | mts. |
| VSX75NE020 | VSX75RT020 | 2,0 | 0,20 | 0,50 | 200 |
| VSX75NE030 | VSX75RT030 | 3,0 | 0,20 | 0,50 | 200 |
| VSX75NE040 | VSX75RT040 | 4,0 | 0,25 | 0,50 | 200 |
| VSX75NE060 | VSX75RT060 | 6,0 | 0,25 | 0,75 | 100 |
| VSX75NE080 | VSX75RT080 | 8,0 | 0,25 | 0,75 | 100 |
| VSX75NE100 | VSX75RT100 | 10,0 | 0,50 | 0,80 | 100 |
| VSX75NE120 | VSX75RT120 | 12,0 | 0,50 | 0,80 | 50 |
| VSX75NE140 | VSX75RT140 | 14,0 | 0,50 | 0,80 | 50 |
| VSX75NE160 | VSX75RT160 | 16,0 | 1,00 | 0,80 | 50 |

REVITEX

VRX10



Tubo trenzado de **fibra de vidrio**, impregnado de barniz de silicona. **expandible**.
Temperatura de trabajo: -70°C a 300°C, puntas de +450°C.

Ratio de expansión 1:2,5. Rigidez dielectrica 1000V. Auto extingible, libre de halógenos, buena resistencia a la abrasión, tacto suave.

Indice de oxígeno: 64,5%.

Aplicaciones: aislamiento térmico, eléctrico y protección de cableados, tubos de combustible y otros componentes sometidos a altas temperaturas. Ideal en calentadores y protección de elementos en sistemas de escape. Su trenzado especial permite la utilización de un mismo tubo, en componentes de medidas irregulares.

Especificaciones: IEC 60684 y UL 1441.

HOMOLOGACION: UL, archivo nº E 151092.

| Ref. ■ Negro | Ref. □ Blanco | Ø MIN. mm. | Ø MAX. mm. | Espesor pared mm. | Rollos mts. |
|-------------------|-------------------|------------------|------------------|-------------------------|----------------|
| VRX10NE040 | VRX10BC040 | 4,00 | 9,00 | 0,85 | 200 |
| VRX10NE060 | VRX10BC060 | 6,00 | 16,00 | 0,85 | 200 |
| VRX10NE080 | VRX10BC080 | 8,00 | 20,00 | 0,85 | 100 |
| VRX10NE100 | VRX10BC100 | 10,00 | 22,00 | 0,85 | 100 |
| VRX10NE120 | VRX10BC120 | 12,00 | 28,00 | 0,85 | 100 |
| VRX10NE140 | VRX10BC140 | 14,00 | 35,00 | 0,85 | 100 |
| VRX10NE160 | VRX10BC160 | 16,00 | 40,00 | 0,85 | 100 |

VHR10



Tubo trenzado de **fibra de vidrio**, impregnado de barniz de silicona.

Temperatura de trabajo: -70°C a 300°C, puntas de +450°C.

Rigidez dielectrica 1000V. Auto extingible, libre de halógenos, buena resistencia a la abrasión, tacto suave. **Indice de oxígeno: 64,5%.**

Aplicaciones: aislamiento térmico, eléctrico y protección de cableados, tubos de combustible y otros componentes sometidos a altas temperaturas. Ideal en calentadores y protección de elementos en sistemas de escape.

Especificaciones: IEC 60684 y UL 1441.

HOMOLOGACION: UL, archivo nº E 151092.

| Ref. ■ Negro | Ø mm. Nominal | Tolerancia + /- mm. | Espesor pared mm. | Rollos mts. |
|-------------------|------------------|------------------------|-------------------------|----------------|
| VHR10NE020 | 2,00 | 0,12 | 0,25 | 400 |
| VHR10NE030 | 3,00 | 0,20 | 0,25 | 300 |
| VHR10NE040 | 4,00 | 0,25 | 0,30 | 300 |
| VHR10NE060 | 6,00 | 0,25 | 0,35 | 200 |
| VHR10NE080 | 8,00 | 0,25 | 0,35 | 200 |
| VHR10NE100 | 10,00 | 0,50 | 0,35 | 200 |
| VHR10NE120 | 12,00 | 0,50 | 0,40 | 100 |
| VHR10NE140 | 14,00 | 0,50 | 0,60 | 100 |
| VHR10NE160 | 16,00 | 1,00 | 0,60 | 100 |

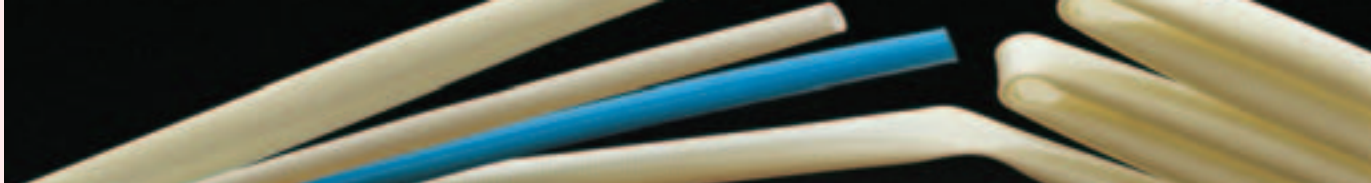

REVITEX

GUF VPG40



Tubo flexible de **fibra de vidrio** recubierto con barniz de **poliuretano**.

Temperatura de trabajo: -25°C a +155°C, puntas de 225°C.

Rigidez dieléctrica: 7000V. Auto extingible, libre de halógenos.

De gran flexibilidad y uniformidad. **Ecológico**, libre de agentes químicos contaminantes, a diferencia de otros poliuretanos convencionales.

Aplicaciones: aislamiento de conexiones eléctricas y terminales, compatible con barnices y resinas de impregnación.

Color: blanco natural.

Especificaciones: IEC 60684-3 página 409 y UL 1441.

HOMOLOGACION: UL, según archivo nº E 121222.

| Ref. | Ø mm. Nominal | Tolerancia + /- mm. | Espesor pared mm. | Rollos mts. |
|-------------------|------------------|------------------------|-------------------------|----------------|
| VPG40IN005 | 0,50 | 0,15 | 0,28 | 400 |
| VPG40IN010 | 1,00 | 0,20 | 0,38 | 300 |
| VPG40IN015 | 1,50 | 0,25 | 0,38 | 300 |
| VPG40IN020 | 2,00 | 0,25 | 0,38 | 300 |
| VPG40IN025 | 2,50 | 0,30 | 0,46 | 200 |
| VPG40IN030 | 3,00 | 0,30 | 0,46 | 200 |
| VPG40IN035 | 3,50 | 0,30 | 0,46 | 200 |
| VPG40IN040 | 4,00 | 0,40 | 0,51 | 200 |
| VPG40IN045 | 4,50 | 0,40 | 0,51 | 200 |
| VPG40IN050 | 5,00 | 0,50 | 0,51 | 200 |
| VPG40IN060 | 6,00 | 0,50 | 0,51 | 100 |
| VPG40IN070 | 7,00 | 0,50 | 0,51 | 100 |
| VPG40IN080 | 8,00 | 0,50 | 0,64 | 100 |
| VPG40IN090 | 9,00 | 0,60 | 0,64 | 100 |
| VPG40IN100 | 10,00 | 0,60 | 0,64 | 100 |
| VPG40IN120 | 12,00 | 0,60 | 0,64 | 50 |
| VPG40IN140 | 14,00 | 0,70 | 0,64 | 50 |
| VPG40IN160 | 16,00 | 0,70 | 0,64 | 50 |



TUBOS

TERMO-RETRACTILES Y OTROS



Tubo termo-retractil de poliolefina XBPT-125°C

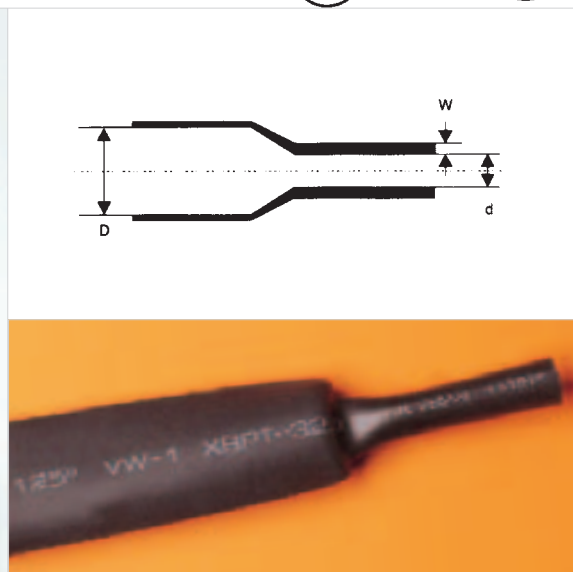
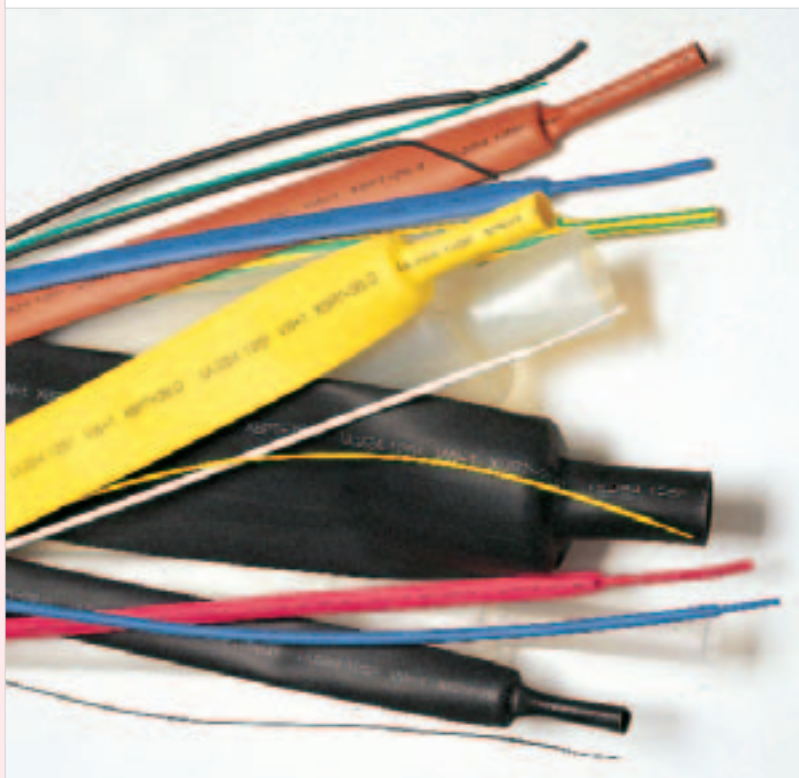

Aplicaciones:

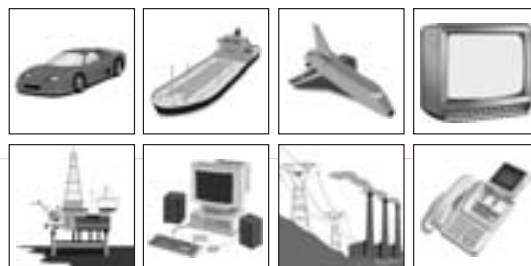

-55°C / +125°C / Contracción: 2:1

El tubo termorretráctil XBPT con su baja temperatura de contracción y sus excelentes propiedades en cuanto a aislamiento, resistencia a la llama, flexibilidad, etc. Lo convierten en un producto muy adecuado para aplicaciones en diversos campos donde se precise el aislamiento eléctrico de cables y conectores, agrupamiento y sujeción de cableados, protección anticorrosión de piezas metálicas, etc.

Material: Poliolefina irradiada, térmicamente estabilizada y retardadora de la llama.

Norma: UL 224 VW-1

C-UL CSA C 22.2 OFT

Temperatura de utilización: -55°C a 125°C

Temperatura de contracción: empieza a 70°C y contrae totalmente a los 110/115°C

Ratio de contracción: 2:1

Colores standard:

■ -NG, □ -BL, ■ -RO, ■ -AM, ■ -AZ,
■ -VE, □ -TR, ■ -AV, ■ -GR, ■ -MA.

Otros colores disponibles bajo demanda.

IMPORTANTE: Recuerde añadir el sufijo de color.

Ej: **XBPT-6,4-NG** (Negro) / **XBPT-6,4-RO** (Rojo).

| Ref. bobina | Ref. barra 1mts. | D Ø interior antes de contraer mm | d Ø interior después de contraer mm | W espesor después de contraer mm |  bobina/ barra mts. |
|-------------------|---------------------|-----------------------------------|-------------------------------------|----------------------------------|--|
| XBPT-1.2 | XBPT-1.2-1 | 1.2 | 0.6 | 0.45 | 300/1 |
| XBPT-1.6 | XBPT-1.6-1 | 1.6 | 0.8 | 0.45 | 300/1 |
| XBPT-2.4 | XBPT-2.4-1 | 2.4 | 1.2 | 0.50 | 150/1 |
| XBPT-3.2 | XBPT-3.2-1 | 3.2 | 1.6 | 0.50 | 150/1 |
| XBPT-4.8 | XBPT-4.8-1 | 4.8 | 2.4 | 0.50 | 150/1 |
| XBPT-6.4 | XBPT-6.4-1 | 6.4 | 3.2 | 0.65 | 75/1 |
| XBPT-9.5 | XBPT-9.5-1 | 9.5 | 4.8 | 0.65 | 75/1 |
| XBPT-12.7 | XBPT-12.7-1 | 12.7 | 6.4 | 0.65 | 75/1 |
| XBPT-19.0 | XBPT-19.0-1 | 19.0 | 9.5 | 0.75 | 75/1 |
| XBPT-25.4 | XBPT-25.4-1 | 25.4 | 12.7 | 0.90 | 30/1 |
| XBPT-32.0 | XBPT-32.0-1 | 32.0 | 16.0 | 0.90 | 30/1 |
| XBPT-38.0 | XBPT-38.0-1 | 38.0 | 19.0 | 1.00 | 30/1 |
| XBPT-51.0 | XBPT-51.0-1 | 51.0 | 25.4 | 1.15 | 30/1 |
| XBPT-76.0 | XBPT-76.0-1 | 76.0 | 38.0 | 1.25 | 15/1 |
| XBPT-102.0 | XBPT-102.0-1 | 102.0 | 51.0 | 1.40 | 15/1 |
| XBPT-127.0 | XBPT-127.0-1 | 127.0 | 63.5 | 1.40 | 20/1 |
| XBPT-152.4 | XBPT-152.4-1 | 152.4 | 76.2 | 1.40 | 20/1 |
| XBPT-177.8 | XBPT-177.8-1 | 177.8 | 88.9 | 1.40 | 20/1 |
| XBPT-203.2 | XBPT-203.2-1 | 203.2 | 101.6 | 1.40 | 20/1 |
| XBPT-228.6 | XBPT-228.6-1 | 228.6 | 114.3 | 1.40 | 20/1 |
| XBPT-254.0 | XBPT-254.0-1 | 254.0 | 127.0 | 1.40 | 20/1 |

SÓLO BAJO DEMANDA

NO STANDARD



Tubo termo-retractil de poliolefina XBHF-125°C

LIBRE DE HALÓGENOS

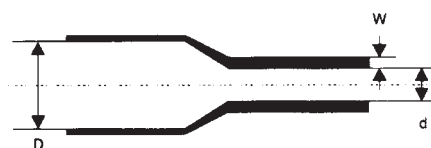

**TUBO TERMO-RETRÁCTIL
LIBRE DE HALÓGENOS**

**HEAT SHRINKABLE TUBE
HALOGEN FREE**

Aplicaciones:

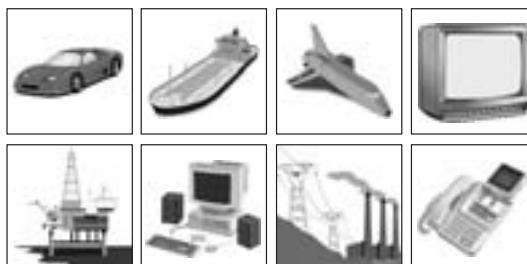

-55°C / +125°C / Contracción: 2:1

El tubo termorretractil libre de halógenos XBHF se ha desarrollado teniendo en cuenta las necesidades medioambientales de manera que su especial compuesto asegure el seguimiento de las normas UL, CSA y SGS en base a sustancias medioambientalmente dañinas como PBB i el PBDE en sus componentes. En caso de combustión no se producen Dioxinas. No contiene Asbestos, compuestos Azo ni Formaldehidos. Además, su baja temperatura de contracción, flexibilidad, superior resistencia mecánica, etc., le confieren unas características muy adecuadas en el campo de la electrónica, comunicaciones, automóvil, etc.

Material: Poliolefina irradiada, térmicamente estabilizada y retardadora de la llama.

Norma: UL 224 VW-1

C-UL CSA C 22.2 OFT

Temperatura de utilización: -55°C a 125°C

Temperatura de contracción: empieza a 70°C y contrae totalmente a los 105/115°C

Ratio de contracción: 2:1

Color: ■ **-NG**

Otros colores bajo demanda.

| Ref. bobina | Ref. barra 1mts. | D Ø interior antes de contraer mm | d Ø interior después de contraer mm | W espesor después de contraer mm | bobina/ barra mts. |
|-------------------|---------------------|-----------------------------------|-------------------------------------|----------------------------------|--------------------|
| XBHF-1.2 | XBHF-1.2-1 | 1.2 | 0.6 | 0.45 | 300/1 |
| XBHF-1.6 | XBHF-1.6-1 | 1.6 | 0.8 | 0.45 | 300/1 |
| XBHF-2.4 | XBHF-2.4-1 | 2.4 | 1.2 | 0.50 | 150/1 |
| XBHF-3.2 | XBHF-3.2-1 | 3.2 | 1.6 | 0.50 | 150/1 |
| XBHF-4.8 | XBHF-4.8-1 | 4.8 | 2.4 | 0.50 | 150/1 |
| XBHF-6.4 | XBHF-6.4-1 | 6.4 | 3.2 | 0.65 | 75/1 |
| XBHF-9.5 | XBHF-9.5-1 | 9.5 | 4.8 | 0.65 | 75/1 |
| XBHF-12.7 | XBHF-12.7-1 | 12.7 | 6.4 | 0.65 | 75/1 |
| XBHF-19.0 | XBHF-19.0-1 | 19.0 | 9.5 | 0.75 | 75/1 |
| XBHF-25.4 | XBHF-25.4-1 | 25.4 | 12.7 | 0.90 | 30/1 |
| XBHF-32.0 | XBHF-32.0-1 | 32.0 | 16.0 | 0.90 | 30/1 |
| XBHF-38.0 | XBHF-38.0-1 | 38.0 | 19.0 | 1.00 | 30/1 |
| XBHF-51.0 | XBHF-51.0-1 | 51.0 | 25.4 | 1.15 | 30/1 |
| XBHF-76.0 | XBHF-76.0-1 | 76.0 | 38.0 | 1.25 | 15/1 |
| XBHF-102.0 | XBHF-102.0-1 | 102.0 | 51.0 | 1.40 | 15/1 |
| XBHF-127.0 | XBHF-127.0-1 | 127.0 | 63.5 | 1.40 | 20/1 |
| XBHF-152.4 | XBHF-152.4-1 | 152.4 | 76.2 | 1.40 | 20/1 |
| XBHF-177.8 | XBHF-177.8-1 | 177.8 | 88.9 | 1.40 | 20/1 |
| XBHF-203.2 | XBHF-203.2-1 | 203.2 | 101.6 | 1.40 | 20/1 |
| XBHF-228.6 | XBHF-228.6-1 | 228.6 | 114.3 | 1.40 | 20/1 |
| XBHF-254.0 | XBHF-254.0-1 | 254.0 | 127.0 | 1.40 | 20/1 |

SÓLO BAJO DEMANDA

NO STANDARD

5 Tubos termo-retractiles y otros



Tubo termo-retractil de poliolefina XBDW-125°C

DE DOBLE PARED CON ADHESIVO INTERNO

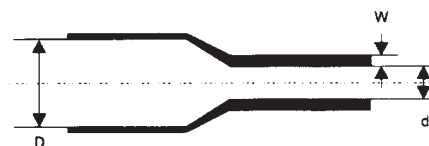

**TUBO TERMO-RETRÁCTIL
CON ADHESIVO INTERNO**

**HEAT SHRINKABLE TUBE
WITH INTERNAL ADHESIVE**

| Ref. bobina | Ref. barra 1mts. | D Ø interior antes de contraer mm | d Ø interior después de contraer mm | W espesor después de contraer mm | bobina/ barra mts. |
|------------------|---------------------|-----------------------------------|-------------------------------------|----------------------------------|--------------------|
| XBDW-3.2 | XBDW-3.2-1 | 3.2 | 1.0 | 0.95 | 200/1 |
| XBDW-4.8 | XBDW-4.8-1 | 4.8 | 1.6 | 1.1 | 100/1 |
| XBDW-6.4 | XBDW-6.4-1 | 6.4 | 2.2 | 1.2 | 100/1 |
| XBDW-7.9 | XBDW-7.9-1 | 7.9 | 2.7 | 1.3 | 100/1 |
| XBDW-9.5 | XBDW-9.5-1 | 9.5 | 3.2 | 1.4 | 60/1 |
| XBDW-12.7 | XBDW-12.7-1 | 12.7 | 4.2 | 1.6 | 60/1 |
| XBDW-15.0 | XBDW-15.0-1 | 15.0 | 5.2 | 1.8 | 60/1 |
| XBDW-19.1 | XBDW-19.1-1 | 19.1 | 6.3 | 2.0 | 60/1 |
| XBDW-25.4 | XBDW-25.4-1 | 25.4 | 8.5 | 2.1 | 60/1 |
| XBDW-30.0 | XBDW-30.0-1 | 30.0 | 10.2 | 2.2 | 1 |
| XBDW-39.0 | XBDW-39.0-1 | 39.0 | 13.5 | 2.4 | 1 |
| XBDW-50.0 | XBDW-50.0-1 | 50.0 | 17.0 | 2.7 | 1 |
| - | XBDW-64.0-1 | 64.0 | 21.0 | 3.0 | 1 |
| - | XBDW-75.0-1 | 75.0 | 25.0 | 3.2 | 1 |
| - | XBDW-90.0-1 | 90.0 | 30.0 | 3.3 | 1 |
| - | XBDW-100.0-1 | 100.0 | 34.0 | 3.5 | 1 |
| - | XBDW-125.0-1 | 125.0 | 42.0 | 3.5 | 1 |

Aplicaciones:

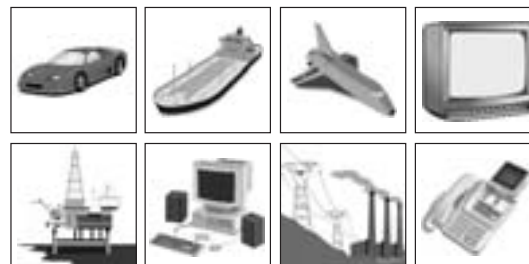

-55°C / +125°C / Contracción: 3:1

El tubo de doble pared XBDW está fabricado por coextrusión de poliolefina y adhesivo de fusión. Está especialmente diseñado para ofrecer simultáneamente el aislamiento y sellado de las piezas a proteger contra agua y humedad.

Temperatura de utilización: -55°C a 125°C

Temperatura de contracción: empieza a 70°C y contrae totalmente a los 120°C

Temperatura de fusión del adhesivo interno: 70-80°C

Ratio de contracción: 3:1

Color: ■ **-NG**

Otros colores bajo demanda.

NO STANDARD



Tubo termo-retráctil en poliolefina. Cajas dosificadoras nueva serie XBC



Colores standard: ■ -NG, □ -BL, ■ -RO, ■ -AM, ■ -AZ, ■ -VE, □ -TR, ■ -AV. Tubo tipo XBPT-125°C

| Ref. | ∅ tubo | mts. | Ref. | ∅ tubo | mts. |
|--------------|--------|------|---------------|--------|------|
| ■ XBC-1.2-NG | 1.2 | 15 | ■ XBC-6.4-NG | 6.4 | 12 |
| ■ XBC-1.2-RO | 1.2 | 15 | ■ XBC-6.4-RO | 6.4 | 12 |
| ■ XBC-1.6-NG | 1.6 | 17 | □ XBC-6.4-TR | 6.4 | 12 |
| ■ XBC-1.6-RO | 1.6 | 17 | ■ XBC-6.4-VE | 6.4 | 12 |
| ■ XBC-2.4-NG | 2.4 | 15 | ■ XBC-6.4-AV | 6.4 | 12 |
| ■ XBC-2.4-RO | 2.4 | 15 | ■ XBC-9.5-AM | 9.5 | 8 |
| ■ XBC-3.2-AM | 3.2 | 15 | ■ XBC-9.5-AZ | 9.5 | 8 |
| ■ XBC-3.2-AZ | 3.2 | 15 | □ XBC-9.5-BL | 9.5 | 8 |
| □ XBC-3.2-BL | 3.2 | 15 | ■ XBC-9.5-NG | 9.5 | 8 |
| ■ XBC-3.2-NG | 3.2 | 15 | ■ XBC-9.5-RO | 9.5 | 8 |
| ■ XBC-3.2-RO | 3.2 | 15 | □ XBC-9.5-TR | 9.5 | 8 |
| □ XBC-3.2-TR | 3.2 | 15 | ■ XBC-9.5-VE | 9.5 | 8 |
| ■ XBC-3.2-VE | 3.2 | 15 | ■ XBC-9.5-AV | 9.5 | 8 |
| ■ XBC-3.2-AV | 3.2 | 15 | ■ XBC-12.7-AM | 12.7 | 8 |
| ■ XBC-4.8-AM | 4.8 | 12 | ■ XBC-12.7-AZ | 12.7 | 8 |
| ■ XBC-4.8-AZ | 4.8 | 12 | □ XBC-12.7-BL | 12.7 | 8 |
| □ XBC-4.8-BL | 4.8 | 12 | ■ XBC-12.7-NG | 12.7 | 8 |
| ■ XBC-4.8-NG | 4.8 | 12 | ■ XBC-12.7-RO | 12.7 | 8 |
| ■ XBC-4.8-RO | 4.8 | 12 | □ XBC-12.7-TR | 12.7 | 8 |
| □ XBC-4.8-TR | 4.8 | 12 | ■ XBC-12.7-VE | 12.7 | 8 |
| ■ XBC-4.8-VE | 4.8 | 12 | ■ XBC-12.7-AV | 12.7 | 8 |
| ■ XBC-4.8-AV | 4.8 | 12 | ■ XBC-19.0-NG | 19.0 | 5 |
| ■ XBC-6.4-AM | 6.4 | 12 | ■ XBC-19.0-RO | 19.0 | 5 |
| ■ XBC-6.4-AZ | 6.4 | 12 | ■ XBC-25.4-NG | 25.4 | 3 |
| □ XBC-6.4-BL | 6.4 | 12 | ■ XBC-25.4-RO | 25.4 | 3 |

CAJAS NEUTRAS



Colores standard: ■ -NG, □ -BL, ■ -RO, ■ -AM, ■ -AZ, ■ -VE, □ -TR, ■ -AV. Tubo tipo XBPT-125°C

| Ref. | ∅ tubo | mts. | Ref. | ∅ tubo | mts. |
|---------------|--------|------|----------------|--------|------|
| ■ XBCN-1.2-NG | 1.2 | 15 | ■ XBCN-6.4-NG | 6.4 | 12 |
| ■ XBCN-1.2-RO | 1.2 | 15 | ■ XBCN-6.4-RO | 6.4 | 12 |
| ■ XBCN-1.6-NG | 1.6 | 17 | □ XBCN-6.4-TR | 6.4 | 12 |
| ■ XBCN-1.6-RO | 1.6 | 17 | ■ XBCN-6.4-VE | 6.4 | 12 |
| ■ XBCN-2.4-NG | 2.4 | 15 | ■ XBCN-6.4-AV | 6.4 | 12 |
| ■ XBCN-2.4-RO | 2.4 | 15 | ■ XBCN-9.5-AM | 9.5 | 8 |
| ■ XBCN-3.2-AM | 3.2 | 15 | ■ XBCN-9.5-AZ | 9.5 | 8 |
| ■ XBCN-3.2-AZ | 3.2 | 15 | □ XBCN-9.5-BL | 9.5 | 8 |
| □ XBCN-3.2-BL | 3.2 | 15 | ■ XBCN-9.5-NG | 9.5 | 8 |
| ■ XBCN-3.2-NG | 3.2 | 15 | ■ XBCN-9.5-RO | 9.5 | 8 |
| ■ XBCN-3.2-RO | 3.2 | 15 | □ XBCN-9.5-TR | 9.5 | 8 |
| □ XBCN-3.2-TR | 3.2 | 15 | ■ XBCN-9.5-VE | 9.5 | 8 |
| ■ XBCN-3.2-VE | 3.2 | 15 | ■ XBCN-9.5-AV | 9.5 | 8 |
| ■ XBCN-3.2-AV | 3.2 | 15 | ■ XBCN-12.7-AM | 12.7 | 8 |
| ■ XBCN-4.8-AM | 4.8 | 12 | ■ XBCN-12.7-AZ | 12.7 | 8 |
| ■ XBCN-4.8-AZ | 4.8 | 12 | □ XBCN-12.7-BL | 12.7 | 8 |
| □ XBCN-4.8-BL | 4.8 | 12 | ■ XBCN-12.7-NG | 12.7 | 8 |
| ■ XBCN-4.8-NG | 4.8 | 12 | ■ XBCN-12.7-RO | 12.7 | 8 |
| ■ XBCN-4.8-RO | 4.8 | 12 | □ XBCN-12.7-TR | 12.7 | 8 |
| □ XBCN-4.8-TR | 4.8 | 12 | ■ XBCN-12.7-VE | 12.7 | 8 |
| ■ XBCN-4.8-VE | 4.8 | 12 | ■ XBCN-12.7-AV | 12.7 | 8 |
| ■ XBCN-4.8-AV | 4.8 | 12 | ■ XBCN-19.0-NG | 19.0 | 5 |
| ■ XBCN-6.4-AM | 6.4 | 12 | ■ XBCN-19.0-RO | 19.0 | 5 |
| ■ XBCN-6.4-AZ | 6.4 | 12 | ■ XBCN-25.4-NG | 25.4 | 3 |
| □ XBCN-6.4-BL | 6.4 | 12 | ■ XBCN-25.4-RO | 25.4 | 3 |

5 Tubos termo-retráctiles y otros



Cajas dosificadoras nueva serie XBC-HF **LIBRE DE HALÓGENOS**



Color standard: ■ **-NG**. Otros colores bajo demanda.
Tubo tipo XBHF-125°C

| Ref. | Ø tubo | mts. |
|------------------|--------|------|
| ■ XBC-HF-1.2-NG | 1.2 | 15 |
| ■ XBC-HF-1.6-NG | 1.6 | 17 |
| ■ XBC-HF-2.4-NG | 2.4 | 15 |
| ■ XBC-HF-3.2-NG | 3.2 | 15 |
| ■ XBC-HF-4.8-NG | 4.8 | 12 |
| ■ XBC-HF-6.4-NG | 6.4 | 12 |
| ■ XBC-HF-9.5-NG | 9.5 | 8 |
| ■ XBC-HF-12.7-NG | 12.7 | 8 |
| ■ XBC-HF-19.0-NG | 19.0 | 5 |
| ■ XBC-HF-25.4-NG | 25.4 | 3 |

**TUBO TERMO-RETRÁCTIL
LIBRE DE HALÓGENOS**

**HEAT SHRINKABLE TUBE
HALOGEN FREE**



Color standard: ■ **-NG**. Otros colores bajo demanda.
Tubo tipo XBHF-125°C

| Ref. | Ø tubo | mts. |
|-------------------|--------|------|
| ■ XBCN-HF-1.2-NG | 1.2 | 15 |
| ■ XBCN-HF-1.6-NG | 1.6 | 17 |
| ■ XBCN-HF-2.4-NG | 2.4 | 15 |
| ■ XBCN-HF-3.2-NG | 3.2 | 15 |
| ■ XBCN-HF-4.8-NG | 4.8 | 12 |
| ■ XBCN-HF-6.4-NG | 6.4 | 12 |
| ■ XBCN-HF-9.5-NG | 9.5 | 8 |
| ■ XBCN-HF-12.7-NG | 12.7 | 8 |
| ■ XBCN-HF-19.0-NG | 19.0 | 5 |
| ■ XBCN-HF-25.4-NG | 25.4 | 3 |

**TUBO TERMO-RETRÁCTIL
LIBRE DE HALÓGENOS**

**HEAT SHRINKABLE TUBE
HALOGEN FREE**



Cajas dosificadoras nueva serie XBC-DW **CON ADHESIVO INTERNO**



Color standard: ■ **-NG**. Otros colores bajo demanda.
Tubo tipo XBDW-125°C

| Ref. | Ø tubo | mts.  |
|---------------|--------|--|
| ■ XBC-DW-3.2 | 3.2 | 10 |
| ■ XBC-DW-4.8 | 4.8 | 8 |
| ■ XBC-DW-6.4 | 6.4 | 6 |
| ■ XBC-DW-7.9 | 7.9 | 6 |
| ■ XBC-DW-9.5 | 9.5 | 5 |
| ■ XBC-DW-12.7 | 12.7 | 4 |
| ■ XBC-DW-15.0 | 15.0 | 3 |
| ■ XBC-DW-19.1 | 19.1 | 2.5 |
| ■ XBC-DW-25.4 | 25.4 | 2 |

**TUBO TERMO-RETRÁCTIL
CON ADHESIVO INTERNO**

**HEAT SHRINKABLE TUBE
WITH INTERNAL ADHESIVE**



Color standard: ■ **-NG**. Otros colores bajo demanda.
Tubo tipo XBDW-125°C

| Ref. | Ø tubo | mts.  |
|----------------|--------|--|
| ■ XBCN-DW-3.2 | 3.2 | 10 |
| ■ XBCN-DW-4.8 | 4.8 | 8 |
| ■ XBCN-DW-6.4 | 6.4 | 6 |
| ■ XBCN-DW-7.9 | 7.9 | 6 |
| ■ XBCN-DW-9.5 | 9.5 | 5 |
| ■ XBCN-DW-12.7 | 12.7 | 4 |
| ■ XBCN-DW-15.0 | 15.0 | 3 |
| ■ XBCN-DW-19.1 | 19.1 | 2.5 |
| ■ XBCN-DW-25.4 | 25.4 | 2 |

**TUBO TERMO-RETRÁCTIL
CON ADHESIVO INTERNO**

**HEAT SHRINKABLE TUBE
WITH INTERNAL ADHESIVE**

5 Tubos termo-retráctiles y otros



Tubo termo-retráctil. Cajas dosificadoras



Ref.: **XB-SGF**

Termo-retráctil en presentación blíster, surtido en colores y medidas 1,6 a 12,7 mm. especialmente diseñado para mayoristas y minoristas del sector eléctrico, auto-eléctrico y electrónico.

(Termo-retráctil tipo XBPT).



Ref.: **XB-SGF-DW**

Termo-retráctil de doble pared con adhesivo interno en color negro y medidas de 3 a 12 mm. especialmente diseñado para mayoristas y minoristas del sector eléctrico, auto-eléctrico y electrónico.

(Termo-retráctil tipo XBDW).



Ref.: **XB-SGF-NG**

Termo-retráctil en presentación blíster, color negro y medidas de 1,6 a 12,7 mm. especialmente diseñado para mayoristas y minoristas del sector eléctrico, auto-eléctrico y electrónico.

(Termo-retráctil tipo TR).

BLÍSTER ECONÓMICO

Expositor EXPOTERM 2004



Ref.: **EXPOTERM-2004**

40 compartimentos para barras de 1 metro de termoretráctil de varios colores.

9 cajas dosificadoras de termoretráctil Toma Tierra amarillo/verde.

1.125 barras de 1 metro de las siguientes medidas: 1.6 - 2.4 - 3.2 - 4.8 - 6.4 - 9.5 - 12.7 - 19.0 y 25.4 en colores amarillo, azul, blanco, negro y rojo.

102 metros de Toma Tierra amarillo/verde.

OPCIONAL:

Expoterm-2004-NG.

Todas las referencias y cajas en termoretráctil negro.



TOMA TIERRA

XBC-3.2-A/V XBC-3.2-A/V XBC-4.8-A/V XBC-4.8-A/V XBC-6.4-A/V XBC-6.4-A/V XBC-9.5-A/V XBC-9.5-A/V XBC-12.7-A/V

Expoterm

2004

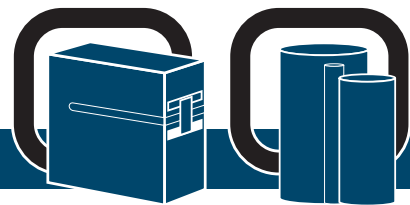

BARRAS 1m

| | | | | | | | |
|--------------------------------------|-------------------------------------|-------------------------------------|-------------------------------------|-------------------------------------|--------------------------------------|--------------------------------------|-------------------------------------|
| XBPT-1.6-NG-1 100 unidades | XBPT-3.2-RO-1 50 unidades | XBPT-4.8-RO-1 40 unidades | XBPT-6.4-RO-1 25 unidades | XBPT-9.5-RO-1 20 unidades | XBPT-12.7-RO-1 15 unidades | XBPT-19.0-RO-1 10 unidades | XBPT-25.4-RO-1 5 unidades |
| XBPT-2.4-NG-1 50 unidades | XBPT-3.2-NG-1 50 unidades | XBPT-4.8-NG-1 40 unidades | XBPT-6.4-NG-1 25 unidades | XBPT-9.5-NG-1 20 unidades | XBPT-12.7-NG-1 15 unidades | XBPT-19.0-NG-1 10 unidades | XBPT-25.4-NG-1 5 unidades |
| XBPT-2.4-BL-1 50 unidades | XBPT-3.2-BL-1 50 unidades | XBPT-4.8-BL-1 40 unidades | XBPT-6.4-BL-1 25 unidades | XBPT-9.5-BL-1 20 unidades | XBPT-12.7-BL-1 15 unidades | XBPT-19.0-BL-1 10 unidades | XBPT-25.4-BL-1 5 unidades |
| XBPT-2.4-AZ-1 50 unidades | XBPT-3.2-AZ-1 50 unidades | XBPT-4.8-AZ-1 40 unidades | XBPT-6.4-AZ-1 25 unidades | XBPT-9.5-AZ-1 20 unidades | XBPT-12.7-AZ-1 15 unidades | XBPT-19.0-AZ-1 10 unidades | XBPT-25.4-AZ-1 5 unidades |
| XBPT-2.4-AM-1 50 unidades | XBPT-3.2-AM-1 50 unidades | XBPT-4.8-AM-1 40 unidades | XBPT-6.4-AM-1 25 unidades | XBPT-9.5-AM-1 20 unidades | XBPT-12.7-AM-1 15 unidades | XBPT-19.0-AM-1 10 unidades | XBPT-25.4-AM-1 5 unidades |

5 Tubos termo-retráctiles y otros



Tubo termo-retráctil en PVC rígido autoextinguible tipo TR

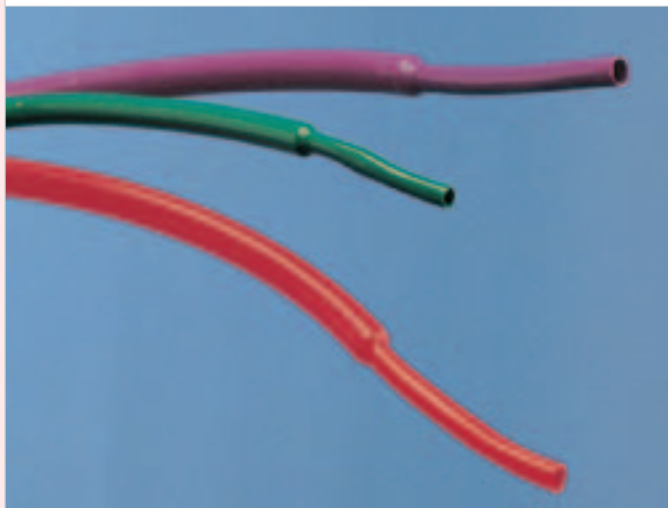

-35°C / +105°C / Contracción: 2:1

Características:

| | | | | |
|-------------------|---|-------|-----------------|---------|
| D:d 2:1 | 1 | >90°C | +105°C -35°C | 20KV/mm |
|-------------------|---|-------|-----------------|---------|

Material: PVC rígido autoextinguible.

Contracción longitudinal: 0-5%.

Temperatura de servicio: -35°C +105°C.

Constante dieléctrica máxima: 4.3.

Rigidez dieléctrica: 20KV/mm.

Colores standard:

■ -AM, ■ -AZ, □ -BL, ■ -GR, ■ -MA, ■ -NG, ■ -RO,

▭ -TR, ■ -VE, ■ -VI. Otros colores bajo demanda.

NOTA IMPORTANTE: Para pedidos, añadir el sufijo correspondiente al color.

Ejemplo: **TR-006,0-NG** (negro) / **TR-006,0-RO** (rojo).

Aplicaciones:

Para recubrir y aislar Ø desde 1,80 a 100 mm.

Para la protección y aislamiento de barras, pletinas, conductores, mangos, tubos, conexiones eléctricas, terminales, condensadores, etc.

Para industria naval, del automóvil, de la madera y otros múltiples usos.

Para pletinas, según la siguiente aplicación:

| Pletina - tubo | Pletina - tubo | Pletina - tubo |
|--------------------|--------------------|---------------------|
| 20 x 3 = TR-020.0 | 40 x 10 = TR-035.0 | 80 x 5 = TR-065.0 |
| 20 x 5 = TR-020.0 | 50 x 5 = TR-044.0 | 80 x 10 = TR-080.0 |
| 30 x 3 = TR-024.0 | 50 x 10 = TR-044.0 | 100 x 5 = TR-080.0 |
| 30 x 5 = TR-028.0 | 60 x 5 = TR-053.0 | 100 x 10 = TR-100.0 |
| 30 x 10 = TR-035.0 | 60 x 10 = TR-053.0 | 120 x 10 = TR-100.0 |
| 40 x 5 = TR-035.0 | | |

| Ref. bobina | Ø D mm | Ø d mm | Espesor antes de contraer mm | Espesor después de contraer mm | mts. bobina |
|-----------------|--------|--------|------------------------------|--------------------------------|-------------|
| TR-003.0 | 3.0 | 1.5 | 0.200 | 0.400 | 100 |
| TR-004.0 | 4.0 | 2.0 | 0.200 | 0.400 | 100 |
| TR-005.0 | 5.0 | 2.5 | 0.200 | 0.400 | 100 |
| TR-006.0 | 6.0 | 3.0 | 0.200 | 0.400 | 100 |
| TR-007.0 | 7.0 | 3.5 | 0.200 | 0.400 | 100 |
| TR-008.0 | 8.0 | 4.0 | 0.220 | 0.440 | 100 |
| TR-010.0 | 10.0 | 5.0 | 0.220 | 0.440 | 50 |
| TR-012.0 | 12.0 | 6.0 | 0.220 | 0.440 | 50 |
| TR-015.0 | 15.0 | 7.5 | 0.220 | 0.440 | 50 |
| TR-020.0 | 20.0 | 10.0 | 0.230 | 0.460 | 50 |
| TR-024.0 | 24.0 | 12.0 | 0.230 | 0.460 | 25 |
| TR-028.0 | 28.0 | 14.0 | 0.230 | 0.460 | 25 |
| TR-035.0 | 35.0 | 17.5 | 0.230 | 0.460 | 25 |
| TR-044.0 | 44.0 | 22.0 | 0.230 | 0.460 | 25 |
| TR-053.0 | 53.0 | 26.5 | 0.250 | 0.500 | 25 |
| TR-065.0 | 65.0 | 32.5 | 0.250 | 0.500 | 25 |
| TR-080.0 | 80.0 | 40.0 | 0.350 | 0.700 | 25 |
| TR-100.0 | 100.0 | 50.0 | 0.350 | 0.700 | 25 |



Tubo termo-retráctil de PVC rígido Tipo HS

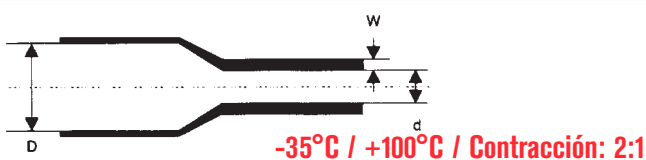

Características:

| | | | | |
|-------------------|---|-------|-----------------|---------|
| D:d 2:1 | 3 | >90°C | +100°C -35°C | 20KV/mm |
|-------------------|---|-------|-----------------|---------|

Material: PVC rígido autoextinguible. Ratio de contracción: 2:1.

Temperatura de contracción: Empieza a los 90° C.

Temperatura de servicio: -35 °C a + 100 °C.

Colores standard: ■ -NG, ■ -AM, ■ -AZ, □ -BL, ■ -RO.

IMPORTANTE: Recuerde añadir el sufijo de color. Para uso en codificaciones por color, aislamiento de pletinas y otras muchas aplicaciones.

| Ref. | Medida en plano mm. | Ø D mm | Ø d mm | Contracción mm | Bobina mts. |
|---------------|---------------------|--------|--------|----------------|-------------|
| HS-6.5 | 6.5 | 4.1 | 3.6 | 6.5~3.6 | 100 |
| HS-8.5 | 8.5 | 5.2 | 4.5 | 8.5~4.5 | 100 |
| HS-12 | 12.0 | 7.6 | 6.5 | 12~6.5 | 100 |
| HS-15 | 15.0 | 10.0 | 8.5 | 15~8.8 | 100 |
| HS-20 | 20.0 | 13.0 | 11.0 | 20~11 | 100 |
| HS-30 | 30.0 | 19.0 | 16.0 | 30~16 | 100 |
| HS-40 | 40.0 | 25.0 | 22.0 | 40~22 | 100 |
| HS-50 | 50.0 | 32.0 | 28.0 | 50~28 | 100 |
| HS-60 | 60.0 | 38.0 | 33.0 | 60~33 | 100 |
| HS-70 | 70.0 | 44.0 | 37.0 | 70~37 | 100 |
| HS-80 | 80.0 | 50.0 | 42.0 | 80~42 | 100 |
| HS-100 | 100.0 | 63.0 | 55.0 | 100~55 | 100 |
| HS-120 | 120.0 | 76.0 | 65.0 | 120~65 | 100 |
| HS-150 | 150.0 | 95.0 | 90.0 | 150~90 | 100 |
| HS-170 | 170.0 | 108.0 | 94.0 | 170~94 | 100 |
| HS-200 | 200.0 | 127.0 | 110.0 | 200~110 | 100 |

Cinta helicoidal



Construcción rápida y económica de haces de cables. Protección flexible del mazo de cables que va hasta la puerta de los paneles eléctricos. Formación o sujeción de haces de pequeños tubos hidráulicos o neumáticos en máquinas de control automático. De fácil aplicación y montaje, proporciona a los haces de cables la máxima protección sin restar flexibilidad. Re-utilizable en nuevos montajes. Temperatura de trabajo: - 60°C y + 85°C.

Material: Polietileno de baja presión.

RETARDADOR DE LA LLAMA

| Ref. | Ø mín. aplicación | Ø mm int/ext | mts. |
|--|-------------------|--------------|------|
| <input type="checkbox"/> CH-9001 | 2.5 | 2.5-4 | 50 |
| <input checked="" type="checkbox"/> CH-9001-1 | 2.5 | 2.5-4 | 50 |
| <input type="checkbox"/> CH-9002 | 4.0 | 4-6 | 50 |
| <input checked="" type="checkbox"/> CH-9002-1 | 4.0 | 4-6 | 50 |
| <input type="checkbox"/> CH-9003 | 6.0 | 6-8 | 50 |
| <input checked="" type="checkbox"/> CH-9003-1 | 6.0 | 6-8 | 50 |
| <input type="checkbox"/> CH-9004 | 9.0 | 9-11 | 50 |
| <input checked="" type="checkbox"/> CH-9004-1 | 9.0 | 9-11 | 50 |
| <input type="checkbox"/> CH-9005 | 12.0 | 12-15 | 25 |
| <input checked="" type="checkbox"/> CH-9005-1 | 12.0 | 12-15 | 25 |
| <input type="checkbox"/> CH-9006 | 16.0 | 16-20 | 25 |
| <input checked="" type="checkbox"/> CH-9006-1 | 16.0 | 16-20 | 25 |
| <input type="checkbox"/> CH-9007 | 20.0 | 20-24 | 25 |
| <input checked="" type="checkbox"/> CH-9007-1 | 20.0 | 20-24 | 25 |



Recogedor-Protector para cables - Una simple y efectiva solución para agrupar cables.



Material: PE / Nylon. Máxima protección de los cables.
Totalmente flexible. Cómoda inserción de los cables mediante aplicador específico (*) y fácil extracción de los mismos. (*) Se suministra aparte.

| Ref. | ØInt. (mm) | ØMax. (mm) | Paso P (mm) | Grosor T(mm) | Rollo m.  |
|------------------|------------|------------|-------------|--------------|--|
| ■ XBW-08B | 8 | 10 | 10 | 0.8 | 100 |
| ■ XBW-15B | 15 | 16 | 14 | 0.8 | 50 |
| ■ XBW-20B | 20 | 23 | 17 | 0.9 | 30 |
| ■ XBW-25B | 25 | 29 | 20 | 1.0 | 20 |
| ■ XBW-30B | 32 | 34 | 24 | 1.4 | 20 |
| ■ XBW-08G | 8 | 10 | 10 | 0.8 | 100 |
| ■ XBW-15G | 15 | 16 | 14 | 0.8 | 50 |
| ■ XBW-20G | 20 | 23 | 17 | 0.9 | 30 |
| ■ XBW-25G | 25 | 29 | 20 | 1.0 | 20 |
| ■ XBW-30G | 32 | 34 | 24 | 1.4 | 20 |
| □ XBW-08W | 8 | 10 | 10 | 0.8 | 100 |
| □ XBW-15W | 15 | 16 | 14 | 0.8 | 50 |
| □ XBW-20W | 20 | 23 | 17 | 0.9 | 30 |
| □ XBW-25W | 25 | 29 | 20 | 1.0 | 20 |
| □ XBW-30W | 32 | 34 | 24 | 1.4 | 20 |



Introducir los cables en el aplicador con la parte curvada hacia arriba.
Colocar el aplicador en el RECOGEDOR-PROTECTOR y deslizarlo a lo largo del mismo. Cortar a la longitud deseada.

APLICADORES:

| Ref. Negro ■ | Ref. Gris □ | Para usar con las siguientes ref. |  |
|---------------|---------------|-----------------------------------|---|
| XB-08B | XB-08G | XBW-08 | 1/10 |
| XB-15B | XB-15G | XBW-15 | 1/10 |
| XB-20B | XB-20G | XBW-20 | 1/10 |
| XB-25B | XB-25G | XBW-25 | 1/10 |
| XB-30B | XB-30G | XBW-30 | 1/10 |

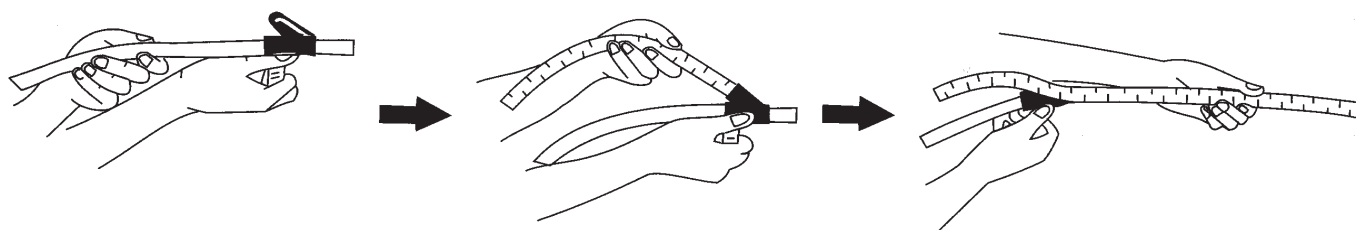



Fundaflex



Color standard: ■ negro. Otros colores bajo demanda.
 Aplicaciones: Funda macarrón en PVC para aislamiento y protección de cables eléctricos.
 Características: NORMA UNE-53020-130-023.

| Ref. | Ø ext. / espesor | Rollo mts. | Ref. | Ø ext. / espesor | Rollo mts. |
|----------------|---------------------|---------------|----------------|---------------------|---------------|
| FX-1.0 | 1 x 0.4 | 250 | FX-17.0 | 17 x 0.5 | 50 |
| FX-2.0 | 2 x 0.4 | 250 | FX-18.0 | 18 x 0.5 | 50 |
| FX-3.0 | 3 x 0.4 | 250 | FX-19.0 | 19 x 0.5 | 50 |
| FX-4.0 | 4 x 0.4 | 200 | FX-20.0 | 20 x 0.5 | 50 |
| FX-5.0 | 5 x 0.4 | 200 | FX-21.0 | 21 x 0.5 | 50 |
| FX-6.0 | 6 x 0.5 | 100 | FX-22.0 | 22 x 0.5 | 50 |
| FX-7.0 | 7 x 0.5 | 100 | FX-23.0 | 23 x 0.5 | 50 |
| FX-8.0 | 8 x 0.5 | 100 | FX-24.0 | 24 x 0.5 | 50 |
| FX-9.0 | 9 x 0.5 | 100 | FX-25.0 | 25 x 0.6 | 50 |
| FX-10.0 | 10 x 0.5 | 100 | FX-26.0 | 26 x 0.6 | 50 |
| FX-11.0 | 11 x 0.5 | 50 | FX-27.0 | 27 x 0.6 | 50 |
| FX-12.0 | 12 x 0.5 | 50 | FX-28.0 | 28 x 0.6 | 50 |
| FX-13.0 | 13 x 0.5 | 50 | FX-30.0 | 30 x 0.6 | 50 |
| FX-14.0 | 14 x 0.5 | 50 | FX-38.0 | 38 x 0.6 | 50 |
| FX-15.0 | 15 x 0.5 | 50 | FX-40.0 | 40 x 0.6 | 50 |
| FX-16.0 | 16 x 0.5 | 50 | | | |



Cristalflex

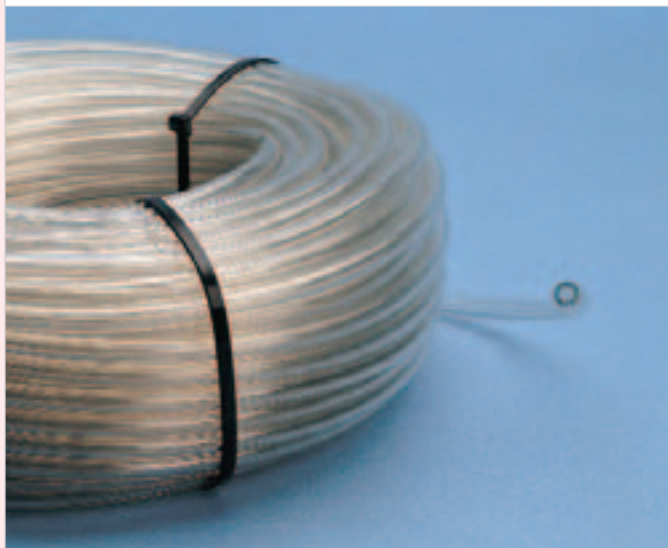

Color: Transparente

Material: Tubo de PVC plastificado, flexible y sin refuerzo.

Totalmente transparente.

Ratio: 78° (+/-0.2).

Aplicaciones: Para la conducción de líquidos en maquinaria, industria, niveles de construcción, etc.

| Ref. | Ø int. / ext. | Rollo mts. | Ref. | Ø int. / ext. | Rollo mts. |
|---------------|---------------|------------|----------------|---------------|------------|
| CX-2 | 2 x 4 | 100 | CX-9-1 | 9 x 12 | 50 |
| CX-3 | 3 x 5 | 100 | CX-9-2 | 9 x 15 | 50 |
| CX-4 | 4 x 6 | 100 | CX-10 | 10 x 12 | 50 |
| CX-5 | 5 x 8 | 50 | CX-10-1 | 10 x 13 | 50 |
| CX-5-1 | 5 x 9 | 50 | CX-10-2 | 10 x 14 | 50 |
| CX-6 | 6 x 8 | 25 | CX-12 | 12 x 15 | 50 |
| CX-6-1 | 6 x 8 | 50 | CX-12-1 | 12 x 16 | 50 |
| CX-6-2 | 6 x 9 | 50 | CX-14 | 14 x 18 | 50 |
| CX-6-3 | 6 x 10 | 50 | CX-15 | 15 x 19 | 50 |
| CX-7 | 7 x 10 | 50 | CX-15-1 | 15 x 20 | 50 |
| CX-7-1 | 7 x 12 | 50 | CX-16 | 16 x 20 | 50 |
| CX-8 | 8 x 10 | 25 | CX-18 | 18 x 23 | 50 |
| CX-8-1 | 8 x 10 | 50 | CX-20 | 20 x 25 | 50 |
| CX-8-2 | 8 x 11 | 50 | CX-25 | 25 x 31 | 50 |
| CX-8-3 | 8 x 12 | 50 | CX-30 | 30 x 37 | 50 |
| CX-8-4 | 8 x 14 | 50 | CX-35 | 35 x 43 | 25 |
| CX-9 | 9 x 11 | 50 | CX-40 | 40 x 50 | 25 |

Gomaflex



Color: negro.

Material: Tubo de PVC y caucho nitrílico.

Temperatura de uso: -10 °C a +60 °C.

Aplicaciones: Diseñado especialmente para el sector de la automoción.

| Ref. | Ø int. / ext. | Rollo mts. | Ref. | Ø int. / ext. | Rollo mts. |
|---------------|---------------|------------|---------------|---------------|------------|
| GX-2 | 2 x 5 | 50 | GX-5 | 5 x 12 | 25 |
| GX-3 | 3 x 7 | 25 | GX-6 | 6 x 10 | 25 |
| GX-4 | 4 x 9 | 25 | GX-6-1 | 6 x 13 | 25 |
| GX-4-1 | 5 x 9 | 25 | GX-8 | 8 x 14 | 25 |

Flexair - Cristal reforzado



Color: cristal transparente. Material: Tubo flexible de PVC reforzado con hilo de poliéster para presiones medias. Conforme ISO-5774. Temperatura de uso: -10 °C a + 75 °C. Aplicaciones: Diseñado especialmente para el sector de la automoción e industria. Básicamente indicado para aire comprimido y agua.

| Ref. | Ø int. / ext. | Rollo mts. | Ref. | Ø int. / ext. | Rollo mts. |
|--------------|---------------|------------|--------------|---------------|------------|
| FR-6 | 6 x 12 | 50 | FR-19 | 19 x 26 | 50 |
| FR-8 | 8 x 14 | 50 | FR-25 | 25 x 32 | 50 |
| FR-10 | 10 x 15 | 50 | FR-30 | 30 x 38 | 50 |
| FR-12 | 12 x 18 | 50 | FR-40 | 40 x 50 | 50 |
| FR-16 | 16 x 22 | 50 | FR-50 | 50 x 60 | 50 |



Azulflex



Color: ■ Azul transparente

Material: Tubo de PVC.

Temperatura de uso:
-10 °C a + 75 °C.

Aplicaciones: Diseñado especialmente
para el sector de la automoción.

Básicamente indicado para gasolina.

| Ref. | Ø int. / ext. | Rollo mts. |
|-------------|---------------|---------------|
| AX-4 | 4 x 8 | 50 |
| AX-5 | 5 x 9 | 50 |
| AX-6 | 6 x 10 | 50 |
| AX-7 | 7 x 12 | 50 |

Vulcaflex



Color: ■ negro.

Aplicaciones y características:

Tubo de caucho vulcanizado, con
refuerzo de lino, máxima flexibilidad
y resistencia a altas temperaturas
sin deformación.

Usos: Inyectores y pasos de gasolina.

| Ref. | Ø int. / ext. | Rollo mts. |
|---------------|---------------|---------------|
| VX-3.2 | 3.2 x 7.0 | 25 |
| VX-5.0 | 5.0 x 10.5 | 25 |
| VX-7.5 | 7.5 x 12.0 | 25 |

Rubiflex



Color: ■ Rojo transparente

Material: Tubo de PVC plastificado.

Temperatura de uso:
-10 °C a + 75 °C.

Aplicaciones: Diseñado especialmente
para el sector de la automoción.

Básicamente indicado para circuito
cerrado

| Ref. | Ø int. / ext. | Rollo mts. |
|--------------|---------------|---------------|
| RX-7 | 7 x 12 | 50 |
| RX-8 | 8 x 12 | 50 |
| RX-14 | 14 x 20 | 25 |

¿Sabía qué...



...X.B. components, s.a. dispone de más de 12.000 referencias agrupadas en 8 catálogos, tanto en versión impresa y CD ROM como en versión PDF descargable desde la página WEB?



CINTAS

ADHESIVAS DE PVC

Y OTRAS



Cintas adhesivas de PVC



0.13mm AUTOEXTINGUIBLE

| Ref. 10M | Ref. 20M | Ref. 25M | Ref. 33M |
|--------------|-------------|-------------|-------------|
| ■ 13.1019-NG | 13.2019-NG | 13.2519-NG | 13.3319-NG |
| ■ 13.1019-AM | 13.2019-AM | 13.2519-AM | 13.3319-AM |
| ■ 13.1019-AV | 13.2019-AV | 13.2519-AV | 13.3319-AV |
| ■ 13.1019-AZ | 13.2019-AZ | 13.2519-AZ | 13.3319-AZ |
| □ 13.1019-BL | 13.2019-BL | 13.2519-BL | 13.3319-BL |
| ■ 13.1019-GR | 13.2019-GR | 13.2519-GR | 13.3319-GR |
| ■ 13.1019-MA | 13.2019-MA | 13.2519-MA | 13.3319-MA |
| ■ 13.1019-RO | 13.2019-RO | 13.2519-RO | 13.3319-RO |
| ■ 13.1019-VE | 13.2019-VE | 13.2519-VE | 13.3319-VE |
| ■ 13.1019-TR | 13.2019-TR | 13.2519-TR | 13.3319-TR |
| 10/100 | 10/250 | 10/200 | 8/48 |



0.15mm AUTOEXTINGUIBLE

| Ref. 10M | Ref. 20M | Ref. 25M | Ref. 33M |
|--------------|-------------|-------------|-------------|
| ■ XB.1019-NG | XB.2019-NG | XB.2519-NG | XB.3319-NG |
| ■ XB.1019-AM | XB.2019-AM | XB.2519-AM | XB.3319-AM |
| ■ XB.1019-AV | XB.2019-AV | XB.2519-AV | XB.3319-AV |
| ■ XB.1019-AZ | XB.2019-AZ | XB.2519-AZ | XB.3319-AZ |
| □ XB.1019-BL | XB.2019-BL | XB.2519-BL | XB.3319-BL |
| ■ XB.1019-GR | XB.2019-GR | XB.2519-GR | XB.3319-GR |
| ■ XB.1019-MA | XB.2019-MA | XB.2519-MA | XB.3319-MA |
| ■ XB.1019-RO | XB.2019-RO | XB.2519-RO | XB.3319-RO |
| ■ XB.1019-VE | XB.2019-VE | XB.2519-VE | XB.3319-VE |
| 10/500 | 10/200 | 10/200 | 8/48 |



0.13 AUTOEXTINGUIBLE
25M x 40mm

| Ref. 25M | |
|--------------|------|
| ■ 13.2540-NG | 5/60 |

Cinta adhesiva de rayón negro



Descripción: Cinta de rayón con goma adhesiva termofijante. De aplicación manual. Muy fácil de rasgar y de fácil y controlado desenrollado.

Color: ■ Negro.

Presentación: En rollos de 25 mts.

Aplicaciones: Automóvil.

Datos técnicos:

| | Unidades | Valor | Método de test |
|--------------------------|----------|-------------------|------------------|
| Grosor | mm | 0.25 ±0.03 | AFERA 4006 |
| Resistencia a la tensión | N/cm | 65 | AFERA 4004 |
| Alargamiento a la rotura | % | 8 | AFERA 4005 |
| Adhesión de la base | N/cm | ≥ 2.00 | AFERA 4001 |
| Clase térmica | °C | 105 - T2 | RENAULT/PSA |
| Resistencia a las llamas | Tipo | B-Autoextinguible | RENAULT D45 1333 |

| Ref. | Dimensiones | |
|--------------|------------------------|------|
| ■ 24.2519-NG | 25mts. x 19mm x 0.24mm | 1/40 |

Cinta adhesiva AUTOVULCANIZABLE



Descripción: Cinta de EPR (Ethylene-propylene rubber) con goma adhesiva en la base.

Color: ■ Negro.

Presentación: En rollos de 10 mts.

Aplicaciones: Aislamiento eléctrico, protección e impermeabilidad de cables.

Óptima resistencia a los agentes atmosféricos y un alto grado de estabilidad.

Datos técnicos:

| | Unidades | Valor | Método de test |
|-------------------------------|----------|----------------------|----------------|
| Grosor | mm | 0.75 | |
| Resistencia a la tensión | MPa | 3 | BS 903 |
| Alargamiento a la rotura | % | 900 | BS 903 |
| Resistividad volumétrica | Ohm.m | 1 x 10 ¹³ | ASTM D257 |
| Ángulo de pérdida dieléctrica | - | 0.005 | ASTM D150 |
| Resistencia dieléctrica | kV/mm | 42 | ASTM D149 |

| Ref. | Dimensiones | |
|-----------------|-------------------------|------|
| ■ 75.1019EPR-NG | 10mts. x 19 mm x 0.75mm | 1/48 |

Cinta no adhesiva AUTOVULCANIZABLE



Descripción: Cinta de PVC. Muy flexible y confortable. Muy buena adhesión a si misma. De fácil control y desenrollado para su aplicación manual.

Color: ■ Negro.

Presentación: En rollos de 40 mts.

Aplicaciones: Cableados del automóvil.

Datos técnicos:

| | Unidades | Valor | Método de test |
|--------------------------|----------|-----------------|----------------|
| Grosor | mm | 0.12 ±0.02 | AFERA 4006 |
| Resistencia a la tensión | N/cm | 20.0 | RENAULT 1009 |
| Alargamiento a la rotura | % | 200 | RENAULT 1009 |
| Desbobinado | N/cm | 2.0 - 6.0 | AFERA 4013 |
| Clase térmica | °C | 85 - Tipo 1 | RENAULT/PSA |
| Auto fusionable | / | Muy bueno | Interno |
| Resistencia a las llamas | / | Autoextinguible | AFERA 4009 |

| Ref. | Dimensiones | |
|--------------|------------------------|------|
| ■ 12.4025-NG | 40mts. x 25mm x 0.12mm | 1/36 |



Cinta adhesiva de PVC plastificado AUTOEXTINGUIBLE



Cinta de PVC blando autoextinguible con goma adhesiva en la base de gran adhesión y resistencia a productos químicos. Flexible, cómoda y de fácil desenrollado. Ofrece facilidad a la rotura transversal.

Aplicaciones: Protección, señalización, sellado y aislamiento especialmente para suelos interiores y exteriores. Conforme a la directiva europea 2000/53 EC (libre de plomo, cromo VI, mercurio y cadmio).

Datos técnicos:

| | Unidades | Valor | Método de test |
|--------------------------|----------|-----------------|----------------|
| Grosor | mm | 0.16 | CEI EN 60454 |
| Resistencia a la tensión | N/cm | 25 | CEI EN 60454 |
| Alargamiento a la rotura | % | 150 | CEI EN 60454 |
| Adhesión a metales | N/cm | 2.0 | CEI EN 60454 |
| Adhesión a bases | N/cm | 2.0 | CEI EN 60454 |
| Flamabilidad | | Autoextinguible | CEI EN 60454 |

| Ref. | Dimensiones | |
|----------------------|---------------------|------|
| ■ 15.3055-BIC | 33mts x 50 x 0.15mm | 1/36 |
| ■ 15.3350-MON | 33mts x 50 x 0.15mm | 1/36 |

Cinta adhesiva IMPERMEABLE



Cinta recubierta de polietileno impermeable con adhesivo ultra resistente y duradero en la base. Flexible y de fácil manejo. Resistente a altas temperaturas.

Colores standard: Color: ■ Negro y ■ plateado.

Otros colores disponibles bajo demanda: □ Blanco, ■ gris, ■ rojo, ■ amarillo, ■ azul, ■ verde y ■ marrón.

Aplicaciones: Especialmente diseñada para cubrir las juntas entre las canaletas de los aires acondicionados y para aislamiento de cables, sellado de mercancías pesadas, codificación por colores y como blindaje contra fugas de gas.

Datos técnicos:

| | Unidades | Valor | Método de test |
|---------------------------|----------|-------|----------------|
| Grosor | mm | 0.3 | Interno |
| Resistencia a la tensión | Ncm | 48 | BS3924 |
| Adhesión a metales | N/cm | 4 | BS3924 |
| Adhesión a bases | N/cm | 2.5 | BS3924 |
| Temperatura máxima de uso | °C | 0-100 | Interno |

| Ref. | Dimensiones | |
|-----------------------|--------------------|-------|
| ■ XB.A5x50-NG | 5mts x 50 x 0.3mm | 1/180 |
| ■ XB.A5x50-PL | 5mts x 50 x 0.3mm | 1/180 |
| ■ XB.A25x50-NG | 25mts x 50 x 0.3mm | 1/48 |
| ■ XB.A25x50-PL | 25mts x 50 x 0.3mm | 1/48 |
| ■ XB.A50x50-NG | 50mts x 50 x 0.3mm | 1/24 |
| ■ XB.A50x50-PL | 50mts x 50 x 0.3mm | 1/24 |



Cinta adhesiva



| Ref. | Dimensiones mm. ancho / largo | |
|---------------|----------------------------------|----|
| DT-8 | 8 x 100 | 10 |
| DT-12 | 12 x 100 | 10 |
| DT-14 | 14 x 100 | 10 |
| DT-18 | 18 x 100 | 10 |
| DT-23 | 23 x 100 | 10 |
| DT-14J | 14 x 25 | 10 |
| DT-18J | 18 x 25 | 10 |

Cinta adhesiva doble cara



| Ref. | Dimensiones mm. ancho / largo | |
|--------------|----------------------------------|----|
| DF-8 | 8 x 50 | 10 |
| DF-13 | 13 x 50 | 10 |
| DF-18 | 18 x 50 | 10 |
| DF-23 | 23 x 50 | 10 |
| DF-28 | 28 x 50 | 10 |

¿Sabía qué...

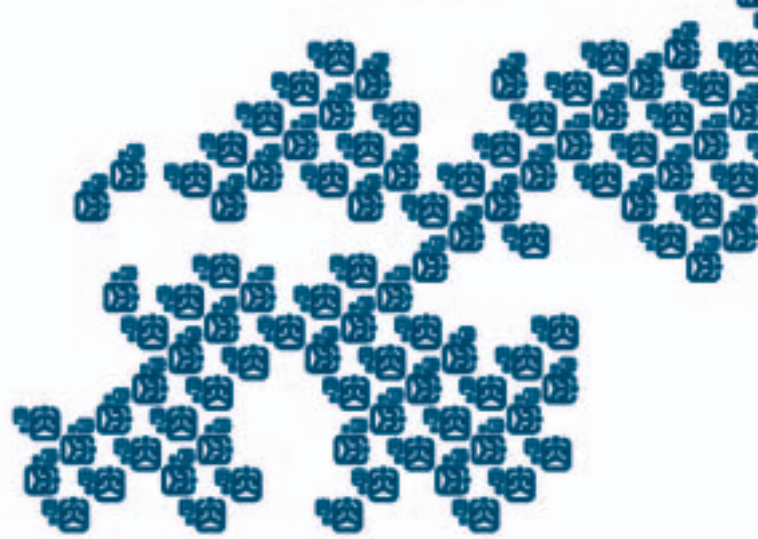

...X.B. components, s.a. distribuye productos hacia toda Europa, América del Sur y Norte de África y procedentes de las más prestigiosas firmas mundiales?

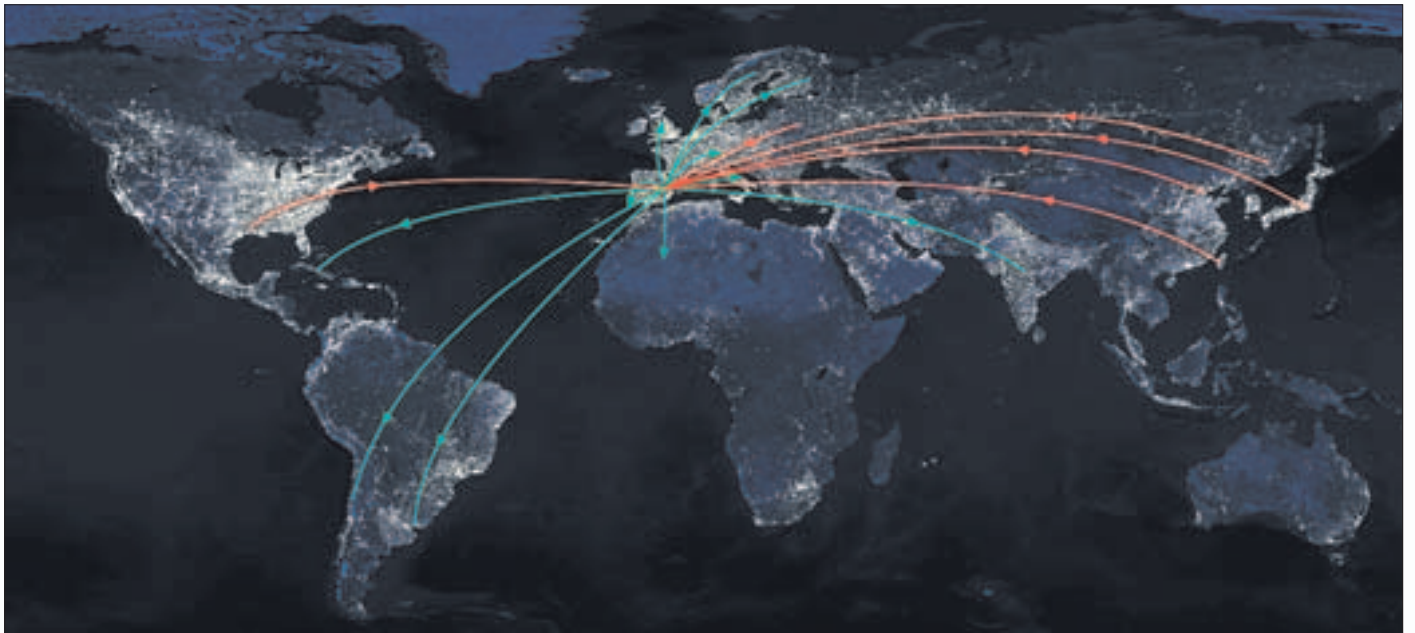

The background is a vibrant blue with a repeating pattern of yellow rings. Some rings are plain yellow, while others have a braided texture. The rings are arranged in a grid-like fashion, with some overlapping. The text 'GUÍAS PASACABLES' is positioned in the lower-left corner, partially overlapping the pattern.

GUÍAS PASACABLES



Serie GPP



Fabricadas en POLIPROPILENO.
Cabezal flexible guiacurvas
y terminal de enganche
DESENROSCABLE de LATÓN.
Son muy flexibles y permiten
una máxima fuerza de arrastre.
Económicas.
Se suministran con solapa
para expositor.

| Ref. | Largo mts. | Ø ext mm | |
|-----------------|---------------|-------------|------|
| GPP-05-M | 5 | 3,9 | 1/10 |
| GPP-10-M | 10 | 3,9 | 1/10 |
| GPP-15-M | 15 | 3,9 | 1/10 |
| GPP-20-M | 20 | 3,9 | 1/10 |
| GPP-25-M | 25 | 3,9 | 1/10 |
| GPP-30-M | 30 | 3,9 | 1/10 |

Serie GPP-F



Fabricadas en POLIPROPILENO.
Cabezal flexible guiacurvas
y terminal de enganche **FIJO**
de LATÓN. Son muy flexibles
y permiten una máxima fuerza
de arrastre. Económicas.
Se suministran con solapa
para expositor.

| Ref. | Largo mts. | Ø ext mm | |
|-----------------|---------------|-------------|------|
| GPP-05-F | 5 | 3,9 | 1/10 |
| GPP-10-F | 10 | 3,9 | 1/10 |
| GPP-15-F | 15 | 3,9 | 1/10 |
| GPP-20-F | 20 | 3,9 | 1/10 |
| GPP-25-F | 25 | 3,9 | 1/10 |
| GPP-30-F | 30 | 3,9 | 1/10 |

Serie GPPAZ



Fabricadas en POLIPROPILENO.
Cabezal flexible guiacurvas
y terminal de enganche
DESENROSCABLE de LATÓN.
Son muy flexibles y permiten
una máxima fuerza de arrastre.
Económicas.
Se suministran con solapa
para expositor.

| Ref. | Largo mts. | Ø ext mm | |
|-------------------|---------------|-------------|------|
| GPPAZ-05-M | 5 | 3,9 | 1/10 |
| GPPAZ-10-M | 10 | 3,9 | 1/10 |
| GPPAZ-15-M | 15 | 3,9 | 1/10 |
| GPPAZ-20-M | 20 | 3,9 | 1/10 |
| GPPAZ-25-M | 25 | 3,9 | 1/10 |
| GPPAZ-30-M | 30 | 3,9 | 1/10 |

Serie GPPAZ-F



Fabricadas en POLIPROPILENO.
Cabezal flexible guiacurvas
y terminal de enganche **FIJO**
de LATÓN. Son muy flexibles
y permiten una máxima fuerza
de arrastre. Económicas.
Se suministran con solapa
para expositor.

| Ref. | Largo mts. | Ø ext mm | |
|-------------------|---------------|-------------|------|
| GPPAZ-05-F | 5 | 3,9 | 1/10 |
| GPPAZ-10-F | 10 | 3,9 | 1/10 |
| GPPAZ-15-F | 15 | 3,9 | 1/10 |
| GPPAZ-20-F | 20 | 3,9 | 1/10 |
| GPPAZ-25-F | 25 | 3,9 | 1/10 |
| GPPAZ-30-F | 30 | 3,9 | 1/10 |



Serie GPN-3. STANDARD



Fabricadas en POLIAMIDA 6. Macizas. Cabezal flexible guia-curvas y terminal de enganche **DESENROSCABLE** de LATÓN. Son muy flexibles y permiten una máxima fuerza de arrastre. Se suministran con solapa para expositor.

| Ref. | Largo mts. | Ø ext mm | |
|-------------------|------------|----------|------|
| GPN-3-05-M | 5 | 3 | 1/10 |
| GPN-3-10-M | 10 | 3 | 1/10 |
| GPN-3-15-M | 15 | 3 | 1/10 |
| GPN-3-20-M | 20 | 3 | 1/10 |
| GPN-3-25-M | 25 | 3 | 1/10 |
| GPN-3-30-M | 30 | 3 | 1/10 |

Serie GPN-3-F



Fabricadas en POLIAMIDA 6. Macizas. Cabezal flexible guia-curvas y terminal de enganche **FIJO** de LATÓN. Son muy flexibles y permiten una máxima fuerza de arrastre. Se suministran con solapa para expositor.

| Ref. | Largo mts. | Ø ext mm | |
|-------------------|------------|----------|------|
| GPN-3-05-F | 5 | 3 | 1/10 |
| GPN-3-10-F | 10 | 3 | 1/10 |
| GPN-3-15-F | 15 | 3 | 1/10 |
| GPN-3-20-F | 20 | 3 | 1/10 |
| GPN-3-25-F | 25 | 3 | 1/10 |
| GPN-3-30-F | 30 | 3 | 1/10 |

Serie GPN. STANDARD



Fabricadas en POLIAMIDA 6. Macizas. Cabezal flexible guia-curvas y terminal de enganche **DESENROSCABLE** de LATÓN. Son muy flexibles y permiten una máxima fuerza de arrastre. Se suministran con solapa para expositor.

| Ref. | Largo mts. | Ø ext mm | |
|-----------------|------------|----------|------|
| GPN-05-M | 5 | 4 | 1/10 |
| GPN-10-M | 10 | 4 | 1/10 |
| GPN-15-M | 15 | 4 | 1/10 |
| GPN-20-M | 20 | 4 | 1/10 |
| GPN-25-M | 25 | 4 | 1/10 |
| GPN-30-M | 30 | 4 | 1/10 |

Serie GPN-F



Fabricadas en POLIAMIDA 6. Macizas. Cabezal flexible guia-curvas y terminal de enganche **FIJO** de LATÓN. Son muy flexibles y permiten una máxima fuerza de arrastre. Se suministran con solapa para expositor.

| Ref. | Largo mts. | Ø ext mm | |
|-----------------|------------|----------|------|
| GPN-05-F | 5 | 4 | 1/10 |
| GPN-10-F | 10 | 4 | 1/10 |
| GPN-15-F | 15 | 4 | 1/10 |
| GPN-20-F | 20 | 4 | 1/10 |
| GPN-25-F | 25 | 4 | 1/10 |
| GPN-30-F | 30 | 4 | 1/10 |



Serie GPNAM



Fabricadas en POLIAMIDA 6. Macizas. Cabezal flexible guiacurvas y terminal de enganche **DESENROSCABLE** de LATÓN. Son muy flexibles y permiten una máxima fuerza de arrastre. Se suministran con solapa para expositor.

| Ref. | Largo mts. | Ø ext mm | |
|-------------------|------------|----------|------|
| GPNAM-05-M | 5 | 4 | 1/10 |
| GPNAM-10-M | 10 | 4 | 1/10 |
| GPNAM-15-M | 15 | 4 | 1/10 |
| GPNAM-20-M | 20 | 4 | 1/10 |
| GPNAM-25-M | 25 | 4 | 1/10 |
| GPNAM-30-M | 30 | 4 | 1/10 |

Serie GPNAM-F

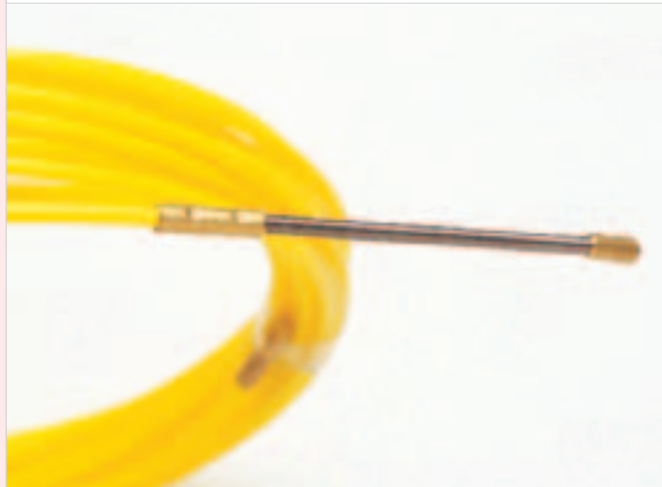

Fabricadas en POLIAMIDA 6. Macizas. Cabezal flexible guiacurvas y terminal de enganche **FIJO** de LATÓN. Son muy flexibles y permiten una máxima fuerza de arrastre. Se suministran con solapa para expositor.

| Ref. | Largo mts. | Ø ext mm | |
|-------------------|------------|----------|------|
| GPNAM-05-F | 5 | 4 | 1/10 |
| GPNAM-10-F | 10 | 4 | 1/10 |
| GPNAM-15-F | 15 | 4 | 1/10 |
| GPNAM-20-F | 20 | 4 | 1/10 |
| GPNAM-25-F | 25 | 4 | 1/10 |
| GPNAM-30-F | 30 | 4 | 1/10 |

Serie GPR. STANDARD



Fabricadas con cable helicoidal de acero recubierto en POLIAMIDA 6. Con cabezal flexible guiacurvas y terminal de enganche **DESENROSCABLE** de LATÓN. Son muy flexibles y permiten una máxima fuerza de arrastre. Máxima calidad. Se suministran con solapa para expositor.

| Ref. | Largo mts. | Ø ext mm | |
|-----------------|------------|----------|------|
| GPR-05-M | 5 | 3,9 | 1/10 |
| GPR-10-M | 10 | 3,9 | 1/10 |
| GPR-15-M | 15 | 3,9 | 1/10 |
| GPR-20-M | 20 | 3,9 | 1/10 |
| GPR-25-M | 25 | 3,9 | 1/10 |
| GPR-30-M | 30 | 3,9 | 1/10 |
| GPR-40-M | 40 | 3,9 | 1/10 |
| GPR-50-M | 50 | 3,9 | 1/10 |

Serie GPR-F



Fabricadas con cable helicoidal de acero recubierto en POLIAMIDA 6. Con cabezal flexible guiacurvas y terminal de enganche **FIJO** de LATÓN. Son muy flexibles y permiten una máxima fuerza de arrastre. Máxima calidad. Se suministran con solapa para expositor.

| Ref. | Largo mts. | Ø ext mm | |
|-----------------|------------|----------|------|
| GPR-05-F | 5 | 3,9 | 1/10 |
| GPR-10-F | 10 | 3,9 | 1/10 |
| GPR-15-F | 15 | 3,9 | 1/10 |
| GPR-20-F | 20 | 3,9 | 1/10 |
| GPR-25-F | 25 | 3,9 | 1/10 |
| GPR-30-F | 30 | 3,9 | 1/10 |
| GPR-40-F | 40 | 3,9 | 1/10 |
| GPR-50-F | 50 | 3,9 | 1/10 |

Serie GPOM

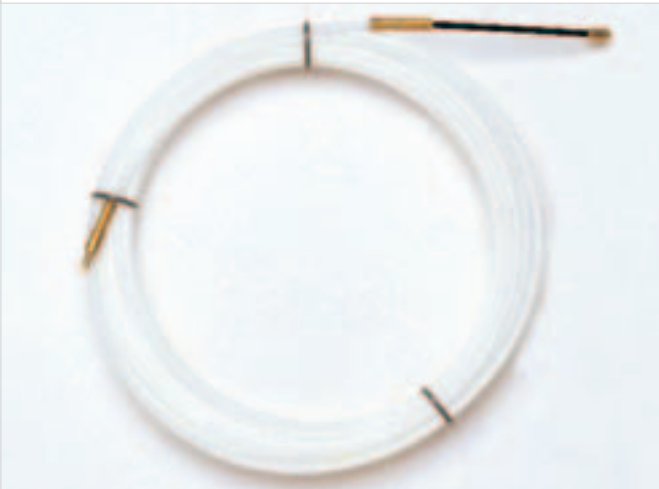

Fabricadas en POM (Resina acetálica). Macizas y muy deslizantes. Cabezal flexible guiacurvas y terminal de enganche **DESENROSCABLE** de LATÓN. Muy resistente a la fricción. Se suministran con solapa para expositor.

| Ref. | Largo mts. | Ø ext mm | |
|------------------|------------|----------|------|
| GPOM-05-M | 5 | 3,9 | 1/10 |
| GPOM-10-M | 10 | 3,9 | 1/10 |
| GPOM-15-M | 15 | 3,9 | 1/10 |
| GPOM-20-M | 20 | 3,9 | 1/10 |
| GPOM-25-M | 25 | 3,9 | 1/10 |
| GPOM-30-M | 30 | 3,9 | 1/10 |

Serie GPOM-F



Fabricadas en POM (Resina acetálica). Macizas y muy deslizantes. Cabezal flexible guiacurvas y terminal de enganche **FIJO** de LATÓN. Muy resistente a la fricción. Se suministran con solapa para expositor.

| Ref. | Largo mts. | Ø ext mm | |
|------------------|------------|----------|------|
| GPOM-05-F | 5 | 3,9 | 1/10 |
| GPOM-10-F | 10 | 3,9 | 1/10 |
| GPOM-15-F | 15 | 3,9 | 1/10 |
| GPOM-20-F | 20 | 3,9 | 1/10 |
| GPOM-25-F | 25 | 3,9 | 1/10 |
| GPOM-30-F | 30 | 3,9 | 1/10 |

Serie GPRN



Fabricadas con cable helicoidal de acero inoxidable recubierto en POLIAMIDA 6 natural. Con cabezal flexible guiacurvas y terminal de enganche **DESENROSCABLE** de LATÓN. Son muy flexibles y permiten una máxima fuerza de arrastre. Máxima calidad. Se suministran con solapa para expositor.

| Ref. | Largo mts. | Ø ext mm | |
|------------------|------------|----------|------|
| GPRN-05-M | 5 | 3,7 | 1/10 |
| GPRN-10-M | 10 | 3,7 | 1/10 |
| GPRN-15-M | 15 | 3,7 | 1/10 |
| GPRN-20-M | 20 | 3,7 | 1/10 |
| GPRN-25-M | 25 | 3,7 | 1/10 |
| GPRN-30-M | 30 | 3,7 | 1/10 |
| GPRN-40-M | 40 | 3,7 | 1/10 |
| GPRN-50-M | 50 | 3,7 | 1/10 |

Serie GPRN-F



Fabricadas con cable helicoidal de acero inoxidable recubierto en POLIAMIDA 6 natural. Con cabezal flexible guiacurvas y terminal de enganche **FIJO** de LATÓN. Son muy flexibles y permiten una máxima fuerza de arrastre. Máxima calidad. Se suministran con solapa para expositor.

| Ref. | Largo mts. | Ø ext mm | |
|------------------|------------|----------|------|
| GPRN-05-F | 5 | 3,7 | 1/10 |
| GPRN-10-F | 10 | 3,7 | 1/10 |
| GPRN-15-F | 15 | 3,7 | 1/10 |
| GPRN-20-F | 20 | 3,7 | 1/10 |
| GPRN-25-F | 25 | 3,7 | 1/10 |
| GPRN-30-F | 30 | 3,7 | 1/10 |
| GPRN-40-F | 40 | 3,7 | 1/10 |
| GPRN-50-F | 50 | 3,7 | 1/10 |



Accesorios - Serie GPN-R

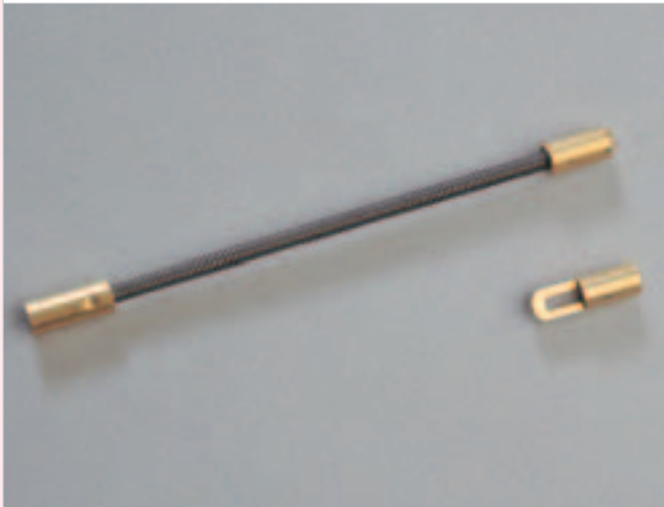

Conjunto de recambio de cabezal y enganche de LATÓN. Son adaptables a todas las series de guías pasacables.

| Ref. | Descripción | |
|----------------|---|---|
| GPN-R | Adaptables a guías series: GPP, GPPAZ, GPN-3, GPN-STANDARD Y GPNAM. | 1 |
| GPN-R-1 | Para serie GPR-STANDARD Y GPOM. | 1 |
| GPN-R-2 | Para serie GPRN. | 1 |

Guía pasacables



Fabricada en polioximetileno (POM) de gran duración y resistencia.

| Ref. | Ø mm | Largo mts. | Carga máx. seguridad Kg | Carga máx. rotura Kg | |
|----------------|------|------------|-------------------------|----------------------|------|
| GPL-415 | 4.5 | 15 | 80 | 135 | 1/70 |
| GPL-420 | 4.5 | 20 | 80 | 135 | 1/60 |
| GPL-430 | 4.5 | 30 | 80 | 135 | 1/50 |
| GPL-450 | 4.5 | 50 | 80 | 135 | 1/30 |

Accesorios - Serie MGP

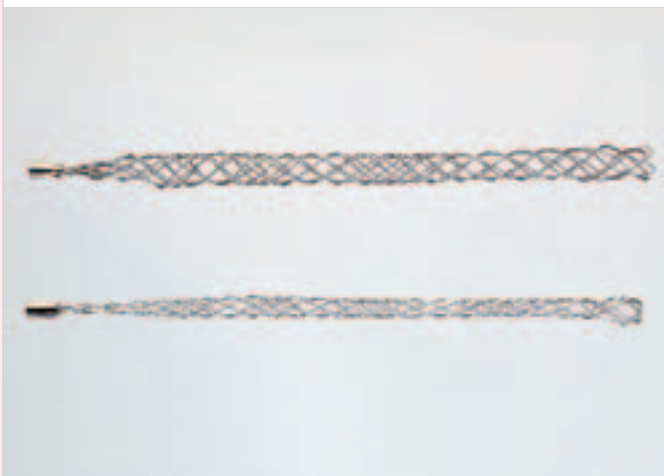

Mallas para arrastre de cables. Fabricadas en ACERO GALVANIZADO. Son adaptables a todas las series de guías pasacables. Se suministran con solapa para expositor.

| Ref. | Para cable de secciones | |
|--------------|-------------------------|------|
| MGP-1 | 5 a 9 | 1/10 |
| MGP-2 | 9 a 13 | 1/10 |

Guía pasacables reforzada



Fabricada con cable de 1,6 mm Ø forrado de polioximetileno (POM)

| Ref. | Ø mm | Largo mts. | Carga máx. seguridad Kg | Carga máx. rotura Kg | |
|----------------|------|------------|-------------------------|----------------------|------|
| GPL-515 | 5.5 | 15 | 250 | 400 | 1/50 |
| GPL-530 | 5.5 | 30 | 250 | 400 | 1/30 |
| GPL-550 | 5.5 | 50 | 250 | 400 | 1/20 |



Guía pasacables reforzada



Fabricada en polioximetileno (POM) de gran duración y resistencia. Color negro. (* CON TUBO PORTA-GUÍA)

| Ref. | Ø mm | Largo mts. | Carga máx. seguridad Kg | Carga máx. rotura Kg |  |
|------------------|------|------------|-------------------------|----------------------|---|
| GPL-615 | 6 | 15 | 400 | 650 | 1/40 |
| GPL-630 | 6 | 30 | 400 | 650 | 1/25 |
| GPL-650 | 6 | 50 | 400 | 650 | 1/18 |
| GPL-6100 | 6 | 100 | 400 | 650 | 1/10 |
| GPL-630T* | 6 | 30 | 400 | 650 | 1/15 |
| GPL-650T* | 6 | 50 | 400 | 650 | 1/10 |

Guía pasacables reforzada



Fabricada en polioximetileno (POM) de gran duración y resistencia. Color amarillo-rojo. (* CON TUBO PORTA-GUÍA)

| Ref. | Ø mm | Largo mts. | Carga máx. seguridad Kg | Carga máx. rotura Kg |  |
|------------------|------|------------|-------------------------|----------------------|---|
| GPL-815 | 7.3 | 15 | 650 | 950 | 1/35 |
| GPL-830 | 7.3 | 30 | 650 | 950 | 1/20 |
| GPL-850 | 7.3 | 50 | 650 | 950 | 1/15 |
| GPL-8100 | 7.3 | 100 | 650 | 950 | 1/10 |
| GPL-830T* | 7.3 | 30 | 650 | 950 | 1/15 |
| GPL-850T* | 7.3 | 50 | 650 | 950 | 1/10 |

Guía pasacables



Fabricada en polioximetileno (POM) de gran duración y resistencia. Color amarillo-negro. (* CON TUBO PORTA-GUÍA)

| Ref. | Ø mm | Largo mts. | Carga máx. seguridad Kg | Carga máx. rotura Kg |  |
|------------------|------|------------|-------------------------|----------------------|---|
| GPL-715 | 7 | 15 | 500 | 850 | 1/35 |
| GPL-730 | 7 | 30 | 500 | 850 | 1/20 |
| GPL-750 | 7 | 50 | 500 | 850 | 1/15 |
| GPL-7100 | 7 | 100 | 500 | 850 | 1/10 |
| GPL-730T* | 7 | 30 | 500 | 850 | 1/15 |
| GPL-750T* | 7 | 50 | 500 | 850 | 1/10 |



Accesorios. Porta guías pasacables



| Ref. | Ø de boca mm | Ø porta guías mm | |
|---------------|--------------|------------------|---|
| GPT-30 | 46 | 580 | 1 |
| GPT-50 | 57 | 610 | 1 |

Cabezales giratorios para guías pasacables

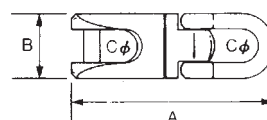

| Ref. | Dimensiones mm | | | Peso gr | Carga de seguridad Kg | |
|--------------|----------------|----|-----|---------|-----------------------|---|
| | A | B | C | | | |
| MGS-1 | 64 | 19 | 9Ø | 70 | 350 | 1 |
| MGS-2 | 72 | 24 | 11Ø | 120 | 600 | 1 |
| MGS-3 | 85 | 28 | 13Ø | 180 | 1.000 | 1 |
| MGS-4 | 100 | 33 | 15Ø | 330 | 1.500 | 1 |
| MGS-5 | 112 | 38 | 17Ø | 460 | 2.000 | 1 |

Accesorios



Para usar en tubos de diámetro 1/2" ~ 1 1/2"

| Ref. | Carga máx. seguridad Kg | | |
|--------------|-------------------------|-----------------|---|
| GPT-2 | 120 | Cable Tightener | 1 |

Pinzas "cocodrilo"

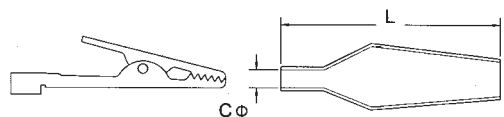

AC-1, AC-2, AC-3

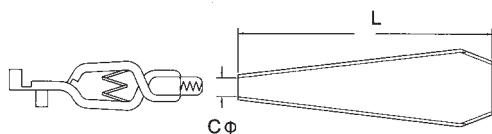

AC-4, AC-5

Colores standard: ■ negro, ■ rojo.

Otros colores bajo demanda: □ blanco, ■ gris, ■ marrón,
■ amarillo, ■ azul, ■ verde.

| Ref. | Dimensiones | | Amperios A |  |
|-----------------|-------------|---|---------------|---|
| | L | C | | |
| ■ AC-1NG | 35 | 3 | 2 | 100 |
| ■ AC-1RO | 35 | 3 | 2 | 100 |
| ■ AC-2NG | 42 | 3 | 3 | 100 |
| ■ AC-2RO | 42 | 3 | 3 | 100 |
| ■ AC-3NG | 50 | 4 | 5 | 100 |
| ■ AC-3RO | 50 | 4 | 5 | 100 |
| ■ AC-4NG | 68 | 4 | 10 | 100 |
| ■ AC-4RO | 68 | 4 | 10 | 100 |
| ■ AC-5NG | 80 | 5 | 20 | 100 |
| ■ AC-5RO | 80 | 5 | 20 | 100 |

Fundas aislantes para pinzas "cocodrilo"

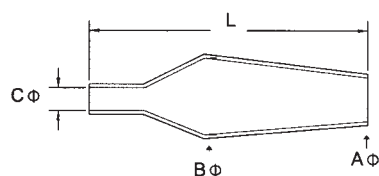

BC-1, BC-2, BC-3

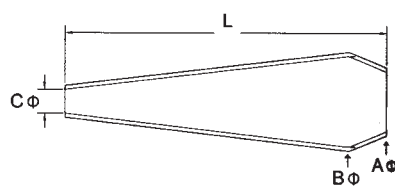

BC-4, BC-5

Colores standard: ■ negro, ■ rojo.

Otros colores bajo demanda: □ blanco, ■ gris, ■ marrón,
■ amarillo, ■ azul, ■ verde.

| Ref. | Dimensiones mm. | | | | Amperios A |  |
|-----------------|-----------------|----|----|---|---------------|---|
| | L | A | B | C | | |
| ■ BC-1NG | 35 | 5 | 9 | 3 | 2 | 100 |
| ■ BC-1RO | 35 | 5 | 9 | 3 | 2 | 100 |
| ■ BC-2NG | 42 | 6 | 10 | 3 | 3 | 100 |
| ■ BC-2RO | 42 | 6 | 10 | 3 | 3 | 100 |
| ■ BC-3NG | 50 | 9 | 13 | 4 | 5 | 100 |
| ■ BC-3RO | 50 | 9 | 13 | 4 | 5 | 100 |
| ■ BC-4NG | 68 | 15 | 16 | 4 | 10 | 100 |
| ■ BC-4RO | 68 | 15 | 16 | 4 | 10 | 100 |
| ■ BC-5NG | 80 | 15 | 21 | 5 | 20 | 100 |
| ■ BC-5RO | 80 | 15 | 21 | 5 | 20 | 100 |

Pilotos LED con resistencia incorporada

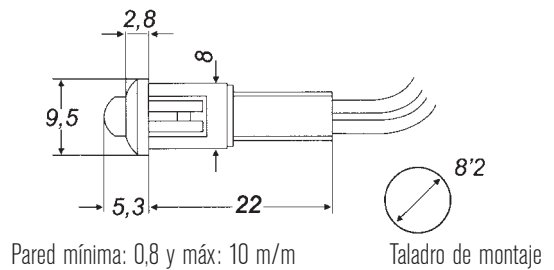

Longitud standard del cable: 200 mm. Otras longitudes y voltajes bajo pedido. Vida útil: 150.000 horas. Polaridad en C.C.: + Cable rojo / - Cable negro
Otras: Insensible a golpes y vibraciones, sin autocebado, sin parpadeos, sin calentamiento, montaje a presión instantáneo.

CORRIENTE ALTERNA:

| Ref. 6V | Ref. 12V | Ref. 24V | Ref. 110V | Ref. 220V | Tensión voltios | CONSUMO C.A. m.A. |
|--------------|-------------------|-------------------|-------------------|-------------------|-----------------|-------------------|
| ■ XB.5700-RO | XB.5100-RO | XB.3300-RO | XB.5400-RO | XB.3000-RO | 6 | 10 |
| ■ XB.5800-VE | XB.5200-VE | XB.3400-VE | XB.5500-VE | XB.3100-VE | 12 | 10 |
| ■ XB.5900-AR | XB.5300-AR | XB.3500-AR | XB.5600-AR | XB.3200-AR | 24 | 10 |
| | | | | | 110 | 7 |
| | | | | | 230 | 7 |
| | | | | | | 📦 : 10/100 |

CORRIENTE CONTINUA:

| Ref. 6V | Ref. 12V | Ref. 24V | Tensión voltios | CONSUMO C.C. m.A. |
|--------------|-------------------|-------------------|-----------------|-------------------|
| ■ XB.5701-RO | XB.5101-RO | XB.3301-RO | 6 | 10 |
| ■ XB.5801-VE | XB.5201-VE | XB.3401-VE | 12 | 10 |
| ■ XB.5901-AR | XB.5301-AR | XB.3501-AR | 24 | 10 |
| | | | | 📦 : 10/100 |

CORRIENTE CONTINUA:

| | Ref. 12V | Ref. 24V | Tensión voltios | CONSUMO INTERMITENTE m.A. |
|--|--------------|-------------------|-----------------|---------------------------|
| | ■ XB.6000-RO | XB.6300-RO | 12 | 5 |
| | ■ XB.6100-VE | XB.6400-VE | 24 | 5 |
| | ■ XB.6200-AR | XB.6500-AR | | |
| | | | | 📦 : 10/100 |



Bolsas de plástico de cierre hermético

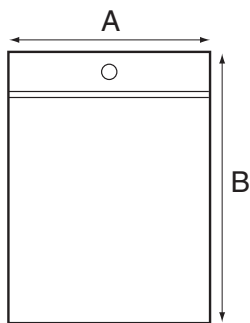

Amplio surtido de bolsas de alta calidad. Según medidas, referencias y envases standard. **NOTA IMPORTANTE:** Únicamente se suministrarán cajas completas de acuerdo con las unidades de envase.

| Ref. | Dimensiones mm. | |  |
|----------------|-----------------|--------|---|
| | A x B | | |
| BMG-001 | 75 x 100 | 15.000 | |
| BMG-002 | 85 x 130 | 10.000 | |
| BMG-003 | 100 x 150 | 8.000 | |
| BMG-004 | 120 x 180 | 6.000 | |
| BMG-005 | 150 x 220 | 4.000 | |
| BMG-006 | 180 x 250 | 3.000 | |
| BMG-007 | 200 x 300 | 2.000 | |
| BMG-008 | 250 x 330 | 2.000 | |
| BMG-009 | 300 x 400 | 1.000 | |