

Partner

MÁQUINAS Y ACCESORIOS 2007



Flymo

Simplicity

CAMON

ÍNDICE

Partner

• Motosierras.....	05
• Accesorios.....	07
• Cortacéspedes.....	17
• Accesorios.....	21
• Sopladores – Aspiradores.....	24
• Cortasetos.....	24
• Tractores Cortacéspedes.....	24
• Accesorios.....	26
• Rebordeadores y Desbrozadores.....	30
• Accesorios.....	34
• Motoazadas.....	44
• Accesorios.....	46
• Otros accesorios.....	49

Flymo

• Cortacéspedes flotantes.....	62
• Cortacéspedes con ruedas.....	63
• Cortabordes y multifunciones eléctricos.....	64
• Minicultivador.....	65
• Aspiradores de exteriores.....	66
• Cortasetos eléctricos.....	66
• Accesorios: cuchillas, hilos de corte, carretes con hilo.....	68

CAMON

• Motosierras.....	72
• Cortacéspedes.....	72
• Escarificador.....	74
• Tractor Cortacéspedes.....	75
• Accesorios cortacéspedes.....	75
• Cortasetos, Segadora de Peine, Rebordeadores y Desbrozadoras.....	77
• Accesorios desbrozadoras.....	78
• Material Zootécnico.....	78
• Molinos eléctricos.....	79
• Accesorios molinos.....	79
• Bombas de presión con motor eléctrico.....	80
• Motobombas 4 tiempos.....	80
• Accesorios bombas de presión.....	81
• Herramientas de poda A.R.S.....	83
• Cortadoras Radiales Dolmar motor 2 tiempos.....	85
• Accesorios de corte en húmedo.....	81
• Carretilla motorizada.....	74
• Discos de diamante.....	86
• Ahoyadores y Biotrituradores Blue Bird.....	87

• Prefiltros y Filtros de Aire adaptables.....	90
• Filtros de Aceite adaptables.....	95
• Carburadores para motores Honda.....	97
• Arrancadores.....	97
• Bobinas.....	98
• Depósitos de Gasolina.....	99
• Interruptores.....	99
• Accesorios para motosierras.....	100
• Filtros de Gasolina.....	103
• Selenoides.....	104
• Bujías.....	105
• Mando arrancador, cuerda de arranque y cable bobina.....	107
• Cabezales de hilo.....	108
• Bobinas Nylon Redondo.....	108
• Discos Desbrozadora.....	108
• Accesorios de protección y ropa de alta visibilidad.....	110
• Bidones y complementos.....	113
• Baterías.....	114
• Útiles para levantar tractores.....	114
• Cuchillas cortacéspedes.....	115
• Porta cuchillas, ejes y correas.....	116
• Ejes para Castलगarden.....	117
• Cámaras y Neumáticos.....	118
• Accesorios para trabajo en el taller.....	119
• Baterías.....	114
• Accesorios para tractores y cortacéspedes.....	120
• Herramientas para Jardín y Poda.....	120

Simplicity

• Tractores Cortacéspedes.....	124
• Biotrituradores.....	125
• Accesorios.....	125

CONDICIONES GENERALES

■ PRECIOS

Según tarifa vigente. Se entiende precios recomendados de venta al público. Por fluctuaciones en la divisa, las tarifas pueden ser modificadas sin previo aviso.

■ CONDICIONES DE ENVÍO

Franco embalajes, desde Lugo. La mercancía viaja por cuenta y riesgo del cliente. (Cualquier anomalía deberá ser reclamada a la recepción de la misma al transportista).

■ APERTURA DE CUENTA

La primera operación deberá ser al contado o a crédito con letras avaladas por una entidad bancaria.

■ CONDICIONES DE PAGO

Contado: El descuento por PRONTO PAGO será del 3%.

Giros: Como norma general, el pago será de 30 días fecha factura para importes inferiores a 150 euros y 30-60 días para importes superiores a 150 euros.

Para el pago mediante efectos, el cliente deberá facilitar domiciliación bancaria, así como el número de cuenta, con el fin de evitar devoluciones.

GAIMA no se hace cargo de los gastos originados por efectos impagados sin domiciliación bancaria.

El cliente correrá con los gastos que se pueden originar de la existencia de un impagado, lo que bloqueará la cuenta del cliente y supondrá la cancelación del crédito.

En caso de alterar el vencimiento de los giros por alguna circunstancia, se avisará con 25 días de antelación al vencimiento.

■ DEVOLUCIÓN DE MERCANCÍA

Cualquier devolución deberá ser, previamente, aceptada por GAIMA siempre que no exceda de 30 días.

■ ABONOS EN GENERAL

Al producirse un abono se hará "albarán o nota de abono" que se liquidará en próximas facturas.

■ GARANTÍAS

Será sustituidas sin cargo, las piezas que se reconozcan como defectuosas de fabricación.

■ RESERVA DE DOMINIO

La disposición de la mercancía no supone la propiedad de la misma, sino que el cliente actúa como depositario hasta su total pago, y queda obligado a las disposiciones establecidas en el artículo 1.766 del Código Civil de las responsabilidades contraídas en el 535 del Código Penal.

MOTOSIERRAS ELÉCTRICAS

Modelo	Referencia	Potencia	Peso*	Longitud barra	P.V.P. Euros	P.V.P. €+IVA
	1750 EL 9675531-66	1700 W	4,4 Kg	16"/40 cm	185,34	215,00
	1950 EL 9675571-66	1950 W	4,4 Kg	16"/40 cm	218,10	253,00
	1640 EL 9539001-73	1650 W	3,6 Kg	16"/40 cm	120,69	140,00
	ES2200 953 9006-94 Novedad	2200 W	3,6 Kg	16"/40 cm	137,07	159,00

MOTOSIERRAS DE GASOLINA

Modelo	Referencia	Cilindrada Potencia	Peso*	Longitud barra	P.V.P. Euros	P.V.P. €+IVA
	352 CCS 9528019-04	35 cc 1,8 HP 1,3 Kw	4,7 Kg	14"/36 cm	200,00	232,00
	401 CCS 9528019-48	40 cc 2,6 HP 1,7 Kw	4,7 Kg	16"/41 cm	233,62	271,00
	422 CCS 9528021-09 Novedad	42 cc 2,7 HP 1,8 Kw	4,7 Kg	16"/41 cm	242,24	281,00
	P4200 9539006-70	42 cc 2,6 HP 2,0 Kw	4,9 Kg	15"/38 cm	350,00	406,00

(*) Peso sin barra ni cadena.

MOTOSIERRAS DE GASOLINA

Modelo	Referencia	Cilindrada Potencia	Peso*	Longitud barra	P.V.P. Euros	P.V.P. €+IVA
	P4600 9539006-56	46 cc 2,9 HP 2,2 Kw	4,9 Kg	18"/45 cm	369,83	429,00
	P5200 9539006-62	51 cc 3,4 HP 2,2 Kw	4,9 Kg	18"/45 cm	421,55	489,00
	411 CCS 9539004-26	40 cc 2,6 HP 2,0 Kw	4,7 Kg	15"/38 cm	385,34	447,00
	511 CCS 9539004-33	49 cc 3,1 HP 2,3 Kw	4,7 Kg	18"/46 cm	468,97	544,00
	543 CCS 9539004-35	54 cc 3,5 HP 2,4 Kw	5,4 Kg	15"/38 cm	510,34	592,00
	543 CCS 9539004-36			18"/46 cm	521,55	605,00
	610 DEKO 9539003-01	59 cc 3,8 HP 2,8 Kw	6,0 Kg	20"/50 cm	540,52	627,00
	720 9539001-89	70 cc 4,5 HP 3,4 Kw	7,3 Kg	20"/50 cm	579,31	672,00

MOTOSIERRAS DE PODA

Modelo	Referencia	Cilindrada Potencia	Peso*	Longitud barra	P.V.P. Euros	P.V.P. €+IVA
	P 33 9539004-57	33 cc 1,8 HP 1,2 Kw	3,1 Kg	12"/30 cm	362,93	421,00

(*) Peso sin barra ni cadena.

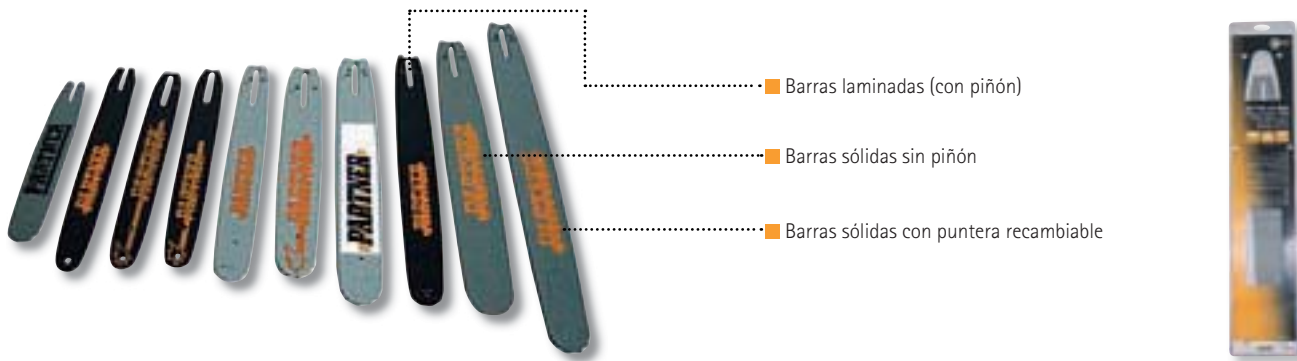

BARRAS LAMINADAS (CON PIÑÓN)

Modelo	Referencia	Longitud Pulgadas/cm	Paso Pulgadas	Canal Pulgadas/mm	Nº Guías	P.V.P. Euros	P.V.P. €+IVA
1436 EL	531 02 42 05	14/36	3/8 Mini	0,43/1,1	52	15,44	17,92
1450 EL-1650 EL	531 02 42 52	15/38	.325	0,50/1,3	64	21,90	25,40
1640 EL-1840 EL - ES 2200	531 02 42 31	16/40	3/8 Hobby	0,50/1,3	55	18,55	21,51
1641 EL	531 02 42 06	16/41	3/8 Mini	0,43/1,1	56	18,55	21,51
1550 -1850 - 1750 - 1950	501 85 52 56	16/41	3/8 Hobby	0,50/1,3	56	25,90	30,04
P33	531 02 42 15	12/31	3/8 Hobby	0,50/1,3	45	13,90	16,13
330-340	501 91 52 45	12/31	3/8 Hobby	0,50/1,3	45	9,90	11,48
335-345-350-351-352	531 02 42 26	14/36	3/8 Hobby	0,50/1,3	52	15,44	17,92
365-370-385-371-395	531 02 42 37	16/41	3/8 Hobby	0,50/1,3	56	18,55	21,51
391-401	538 24 89 78	16/40	3/8 Hobby	0,50/1,3	56	26,20	30,39
420-Fórmula 5000	531 02 42 48	18/46	3/8 Hobby	0,50/1,3	62	19,32	22,41
360-400-405-450	508 91 22 64	15/38	.325	0,58/1,5	64	22,90	26,56
465-495-500-545-5000-5500-540	508 91 22 72	18/46	.325	0,58/1,5	72	23,90	27,72
410-540-411-543-4200	531 02 42 52	15/38	.325	0,50/1,3	64	21,90	25,40
460-461-470-510-511-540 543-4600-5200	531 02 42 55	18/46	.325	0,50/1,3	72	23,90	27,72
660-710-7700	508 91 36 68	18/46	3/8	0,58/1,5	68	24,95	28,94
660-710-7700	501 95 84 72	20/51	3/8	0,58/1,5	72	35,90	41,64
S50-S55-S65-P70-550-650-7000	501 95 93 64	17/43	3/8	0,58/1,5	64	29,90	34,68

BARRAS SÓLIDAS CON PUNTERA RECAMIABLE

660-710-7700	501 95 69 68	18/45	3/8	0,58/1,5	68	53,90	62,52
660-710-7700	501 95 85 84	24/61	3/8	0,58/1,5	84	56,43	65,46
660-710-7700	501 95 85 92	28/71	3/8	0,58/1,5	92	63,35	73,49
610-720	538 24 84 35	20/50	3/8	0,58/1,5	72	58,90	68,32

BARRAS SÓLIDAS (SIN PIÑÓN)

660-710-7700	501 95 80 68	18/45	3/8	0,58/1,5	68	62,00	71,94
660-710-7700	501 95 86 72	20/51	3/8	0,58/1,5	72	42,35	49,13
660-710-7700	501 95 86 84	24/61	3/8	0,58/1,5	84	69,90	81,08
660-710-7700	501 95 86 92	28/71	3/8	0,58/1,5	92	75,00	87,00



CADENAS ELECTROLUX

Modelo Partner	Referencia	Paso	Tipo	Nº Guías	Canal	P.V.P. Euros	P.V.P. €+IVA
1436 EL	531 02 41 05	3/8	Mini Cut	52	0,43/1,1	10,80	12,53
1450 EL-1650 EL	531 02 41 34	.325	Slim Cut	64	0,50/1,3	11,57	13,42
1640 EL-1840 EL-ES 2200	531 02 41 26	3/8	Hobby Cut	55	0,50/1,3	11,57	13,42
1641 EL	531 02 41 06	3/8	Mini Cut	56	0,43/1,1	11,57	13,42
1550-1850-1750-1950	531 02 41 27	3/8	Hobby Cut	56	0,50/1,3	11,57	13,42
P33 - MCV331T	531 02 41 15	3/8	Hobby Cut	45	0,50/1,3	10,03	11,64
335-345-350-351-352	531 02 41 22	3/8	Hobby Cut	52	0,50/1,3	10,80	12,53
365-370-385-395-371-391-401	531 02 41 27	3/8	Hobby Cut	56	0,50/1,3	11,57	13,42
420-Fórmula 5000	531 02 41 32	3/8	Hobby Cut	62	0,50/1,3	13,13	15,24
360-400-405-450	531 02 41 53	.325	Pro Cut	64	0,58/1,5	10,12	11,74
465-495-500-545-5000-5500-540	531 02 41 54	.325	Pro Cut	72	0,58/1,5	11,09	12,86
410-411-540-543-4200	531 02 41 34	.325	Slim Cut	64	0,50/1,3	11,57	13,42
460-461-470-510-540-511 543-4600-5200	531 02 41 37	.325	Slim Cut	72	0,50/1,3	13,13	15,24
605-660-710-7700	531 02 41 58	3/8	Pro Cut	68	0,58/1,5	12,78	14,83
S50-S55-S65-P70-550-650-7000	531 02 41 57	3/8	Pro Cut	64	0,58/1,5	12,23	14,19
660-710-720-7700-610	540 06 26 01	3/8	Pro Cut	72	0,58/1,5	13,60	15,77

OTRAS MARCAS

	531 02 41 21	3/8	Hobby Cut	50	0,50/1,3	10,80	12,53
MCV381	531 02 41 28	3/8	Hobby Cut	57	0,50/1,3	11,57	13,42
	531 02 41 31	3/8	Hobby Cut	60	0,50/1,3	13,13	15,24
	531 02 41 36	.325	Slim Cut	66	0,50/1,3	11,57	13,42
	531 02 41 56	3/8	Pro Cut	60	0,58/1,5	11,64	13,50

PIÑONES BARRAS LAMINADAS Y SÓLIDAS CON PUNTERA

Modelo	Referencia	Tipo	Dientes	Paso	Canal	P.V.P. Euros	P.V.P. €+IVA
	501 85 10 01	EM	10 T	.325	1,5	8,69	10,08
	501 85 10 02	EM	10 T	3/8	1,5	8,69	10,08
	501 85 10 05	EM	10 T	325	1,3	7,90	9,16
	501 95 74 01	Oregón	11 T	3/8	1,5	9,37	10,87
	501 95 75 01	Oregón	11 T	3/8	1,5	20,06	23,27
	501 91 14 01	Pistola engrasadora piñones barras				4,73	5,49
	503 62 12 01	Grasa especial piñones barras				2,24	2,60

REMACHES CADENA CARLTON

Modelo	Referencia	Denominación	Paso Pulgadas	Tipo Cadena	P.V.P. Euros	P.V.P. €+IVA
	538 04 30 11	Bolsa 25 remaches	3/8 Hobby	N150C	13,95	16,18
	538 04 30 02	Bolsa 25 cintas			6,90	8,00
	538 04 30 07	Bolsa 25 remaches	325	K250C K258C	13,95	16,18
	538 04 30 01	Bolsa 25 cintas			6,90	8,00
	538 04 30 16	Bolsa 25 remaches	3/8	A350EP A358EP	13,95	16,18
	538 04 30 05	Bolsa 25 cintas			6,90	8,00

REMACHES CADENA E.M. PARTNER

Modelo	Referencia	Denominación	Paso Pulgadas	Tipo Cadena	P.V.P. Euros	P.V.P. €+IVA
	501 84 81 05	Remache	3/8 Hobby	S36X 91VG 91VS	0,73	0,85
	501 84 78 05	Cinta			0,66	0,77
	501 84 80 05	Remache	325	S25 / 21VB S30 / 95VP	0,73	0,85
	501 84 77 03	Cinta			0,66	0,77
	501 84 81 04	Remache	3/8	S42 / 73VL	0,73	0,85
	501 84 78 04	Cinta			0,66	0,77



ROLLOS DE CADENA E.M. PARTNER

Referencia	Tipo Partner	Tipo Oregón	Paso Pulgadas	Canal Pulgadas/mm	NºGuías	Diente	P.V.P. Euros	P.V.P. €+IVA
503 30 68 22	S36	91VG	3/8 Hobby	0,50/1,3	1640	Redondo doble guía	362,00	419,92
503 30 69 01	91VS	91VS	3/8 Hobby	0,50/1,3	1640	Redondo	362,00	419,92
503 30 07 23	S25LV	21BP	.325	0,58/1,5	1848	Redondo	393,00	455,88
503 30 59 23	S30	95VP	.325	0,50/1,3	1848	Redondo	380,00	440,80
503 30 50 22	S49	73DP	3/8	0,58/1,5	1640	Redondo	392,00	454,72
503 30 23 23	S42LV	73LP	3/8	0,58/1,5	1640	Cuadrado	394,00	457,04

LV=Doble guía

ROLLOS DE CADENA CAMON

Referencia	Tipo	Paso Pulgadas	Canal Pulgadas/mm	NºGuías	Diente	P.V.P. Euros	P.V.P. €+IVA
E650MC-K-100R	E650MC-K-100R	1/4"	0,50/1,3	2400	Redondo	342,00	396,72
N143C-K-100R	N143C-K-100R	3/8 Hobby	0,43/1,1	1640	Redondo doble guía	236,00	273,76
538 08 79 55	N150C-N-100R	3/8 Hobby	0,50/1,3	1640	Redondo	233,00	270,28
519 54 48 00	N150C-K-100R	3/8 Hobby	0,50/1,3	1640	Redondo doble guía	236,00	273,76
538 22 59 57	K250C-K-100R	.325	0,50/1,3	1848	Redondo doble guía	239,00	277,24
538 20 59 10	K258C-K-100R	.325	0,58/1,5	1848	Redondo doble guía	242,00	280,72
519 54 51 00	A350EP-K-100R	3/8	0,50/1,3	1640	Redondo doble guía	236,00	273,76
538 22 85 39	A358EP-K-100R	3/8	0,58/1,5	1640	Redondo doble guía	236,00	273,76
538 22 85 38	A358EP-N-100R	3/8	0,58/1,5	1640	Redondo	242,00	280,72
538 08 99 01	A358LM-K-100R	3/8	0,58/1,5	1640	Cuadrado doble guía	242,00	280,72
519 54 54 01	B463EP-N-100R	404	0,63/1,6	1484	Redondo	270,00	313,20

ACCESORIOS PARA CADENAS

Modelo	Referencia	Descripción	P.V.P. Euros	P.V.P. €+IVA
	538 20 14 33	Máquina de afilar 220 V Contiene: <ul style="list-style-type: none"> • Piedra de afilar 325 • Piedra de afilar 3/8 • Piedra guías cadena 	530,00	614,80
	538 23 64 01	Rompedor de cadenas Contiene: <ul style="list-style-type: none"> • Punzón rompedor • Yunque 	92,95	107,82
	538 23 64 03	Remachador de cadenas Contiene: <ul style="list-style-type: none"> • Prisma 325 • Prisma 3/8 	71,95	83,46

ACCESORIOS REPUESTO

Modelo	Referencia	Descripción	P.V.P. Euros	P.V.P. €+IVA
	538 20 14 34	Piedra de afilar 145x3x22 325" y 1/4"	16,04	18,60
	538 20 14 35	Piedra de afilar 145x4,5x22 3/8" y 404"	16,39	19,01
	538 20 14 36	Piedra guía cadenas	13,79	16,00
	538 23 64 02	Punzón rompedor	4,90	5,68
	538 23 64 05	Yunque	9,75	11,31
	538 23 64 06	Prisma 325" y 1/4"	4,90	5,68
	538 23 64 07	Prisma 3/8" y 404"	4,90	5,68

MANGOS Y LIMAS PARTNER



Descripción	Tipo de lima	Referencia	P.V.P. Euros	P.V.P. €+IVA
Mango para limas Adecuado para limas redondas de 4,0 a 5,5 mm y limas planas de 6". El ángulo de 25° y 30° asegura un limado perfecto.	Redonda/plana 6"	531 02 54 06	2,45	2,84
	Plana 8"	505 69 78 10	2,16	2,50



Descripción	Grosor	Referencia	P.V.P. Euros	P.V.P. €+IVA
60 uds. Lima Redonda	4,0 mm (5/32")	531 02 54 12	47,08	54,61
60 uds. Lima Redonda	4,8 mm (3/16")	531 02 54 13	47,08	54,61
60 uds. Lima Redonda	5,5 mm (7/32")	531 02 54 14	47,08	54,61



Descripción	Unidades Grosor	Referencia	P.V.P. Euros	P.V.P. €+IVA
Lima Redonda	4,0 mm (5/32")	505 68 81 40	0,95	1,10
Lima Redonda	4,8 mm (3/16")	505 68 81 48	0,95	1,10
Lima Redonda	5,5 mm (7/32")	505 68 81 55	0,95	1,10



Descripción	Medida	Referencia	P.V.P. Euros	P.V.P. €+IVA
Limas planas (Blister 1 unidad)	6"	531 02 54 07	2,31	2,68
	8"	505 68 81 80	3,21	3,73



Descripción	Paso	Tipo	Referencia	P.V.P. Euros	P.V.P. €+IVA
Rodillos de afilado Diseñados para proporcionar el ángulo de limado perfecto	.325	S25 (21 BP)	505 69 81 10	7,37	8,55
	.325	S24 (34LG)	505 69 81 11	7,08	8,22
	3/8	S42 (73LP)	505 68 81 12	6,43	7,46
	3/8 Hobby	S36 (91 SG)	505 69 81 14	7,37	8,55

ACCESORIOS LIMADO

Calibrador de profundidad

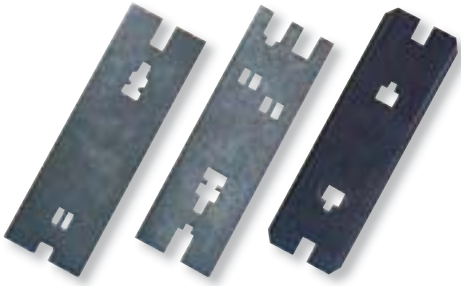

Descripción	Paso / Tipo	Referencia	P.V.P. Euros	P.V.P. €+IVA
La profundidad perfecta para óptimos resultados	.325" / S25	505 69 81 00	2,57	2,99
	3/8" / S42	505 69 81 01	2,57	2,99
	3/8" Hobby / S36	505 69 81 03	2,57	2,99

Rodillo + Calibrador



Paso / Tipo	Referencia	P.V.P. Euros	P.V.P. €+IVA
3/8 1,5 / S42	505 69 81 07	8,18	9,49
.325 1,3 / S30	505 69 81 08	7,15	8,29
.325 1,5 / S25	505 69 81 09	8,18	9,49

Kit de afilado



Descripción	Paso / Tipo	Referencia	P.V.P. Euros	P.V.P. €+IVA
Mango, rodillo de afilar con calibrador, 2 limas redondas y 1 lima plana. El calibrador asegura el ángulo perfecto simplificando el afilado.	3/8" Hobby 91SG	531 02 54 01	11,35	13,17
	3/8" Hobby	531 02 54 09	11,35	13,17
	.325	531 02 54 10	11,35	13,17

Calibrador de limado desbrozadoras



Descripción	Paso / Tipo	Referencia	P.V.P. Euros	P.V.P. €+IVA
Calibrador que incluye lima para hojas de desbrozadoras. Asegura una óptima técnica de afilado y triscado correcto.	Calibrador	531 02 54 08	7,72	8,96
	Funda	505 69 32 20	9,50	11,02

FUNDAS BARRAS



Referencia	Pulgadas	Tipo	Color	P.V.P. Euros	P.V.P. €+IVA
501 83 44 14	14" - 16"	1 Partner	Gris	4,50	5,22
501 83 44 15	18" - 22"	1 Partner	Gris	4,53	5,26
538 24 04 50	18"	2 Neutra	Gris	2,97	3,45

CUERDA DE ARRANQUE DE POLIESTER Y ALGODÓN



Referencia	Longitud	Grosor ø	Tipo	P.V.P. Euros	P.V.P. €+IVA
531 00 38 75	100 m	3.0 mm	Bobina	26,22	30,42
531 00 38 76	100 m	3.5 mm	Bobina	33,44	38,79
531 00 38 77	100 m	4.0 mm	Bobina	42,81	49,66
531 00 38 78	100 m	4.5 mm	Bobina	48,20	55,91

LLAVES COMBINADAS

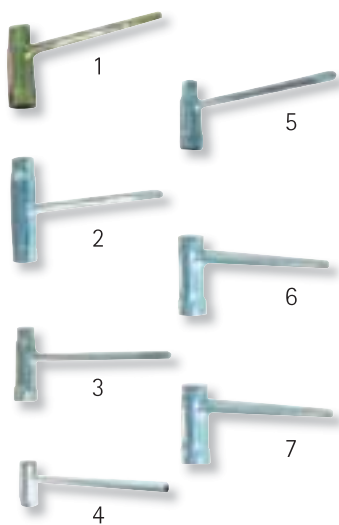

Referencia	Medida tuerca	Medida bujía	Modelos	P.V.P. Euros	P.V.P. €+IVA
538 01 42 20	(1) 10 mm	16 mm	Otras Marcas	5,96	6,92
531 02 56 22	(1) 13 mm	16 mm	P461 - P720	4,03	4,67
538 01 42 19	(2) 11 mm	16 mm	Otras Marcas	6,12	7,09
538 02 76 36	(3) 13 mm	19 mm	Otras Marcas	4,47	5,18
501 69 17 01	(4) 13 mm	19 mm	351-370-420-410-470-540-510	2,05	2,37
530 03 10 94	(5) 14 mm	19 mm	465-495-545-605	3,94	4,57
531 02 56 19	(6) 16 mm	17 mm	B246-B260-B310-B341-B400-B470-B4700	4,05	4,70
502 11 46 02	(7) 19 mm	-	B380-B405-B440-B450	5,72	6,64

BOLSA HERRAMIENTAS



Referencia	Descripción	Modelos	P.V.P. Euros	P.V.P. €+IVA
538 23 66 67	Kit llaves	B260-B261-B310-B341 B400-B420-B470-B4700	8,69	10,08
502 21 60 10	Kit llaves	B380-B405-B440-B450	4,05	4,70

CODO ENGRANAJES



Referencia	Referencia	P.V.P. Euros	P.V.P. €+IVA
538 24 17 40	B245 - B246	37,33	43,34
538 24 14 26	B260 - B261 - B310 - B341 - B251 (hembra)	58,23	67,55
538 24 27 28	B261 - B251 - B341 (macho)	56,65	65,71
538 24 08 24	B400 - B420 - B422X - B470 - B472X - B522M	63,95	74,18
502 28 57 04	B380 - B405 - B450	122,90	142,56
502 27 11 02	B440	150,90	175,04
AI725240 A	EK28 - C26M - C34M	87,55	101,56
AI722760	R29 - R41 - R54 - F41 - F54 - P410M	109,01	126,45

CARBURADORES



Referencia		Referencia	P.V.P. Euros	P.V.P. €+IVA
530 07 18 20	ZAMA W20 WT662	352 - 401	57,97	67,25
530 07 16 21	WT625	351 - 352 - 370 - 401 - 420 - F5000	57,97	67,25
530 07 16 93	WT610	365 - 405 - 470	57,97	67,25
530 03 52 01	HDA49	465 - 495 - 545 - 605	62,46	72,45
503 28 13 20	WT99	400 - 450 - B380 - B405 - B450	57,97	67,25
503 28 31 09	ZAMA	B405 - B450	57,97	67,25
503 28 31 01	ZAMA	410 - 411 - 460 - 510 - 511	57,97	67,25
538 24 29 38	WT414	461	57,97	67,25
505 31 66 21	HS175D	S50-S55-S65-550-650-7000-K1200	63,95	74,18
503 28 15 04	WT170	540 - 543	57,97	67,25
538 24 13 11	WJ82	610	71,90	83,40
503 28 12 20	WJ28B	660 - 710 - 7700	71,90	83,40
538 24 29 37	WJ23A	720	71,90	83,40
538 24 31 87	WT738	4200 - 4600 - 5200	57,97	67,25
538 24 29 32	WT547	B245 - B246 - B260 - B261	57,97	67,25
538 24 29 49	WT694 WT255	B310 - B341	57,97	67,25
538 24 12 68	WYJ183A	B400 - B470 - B422X - B472X	72,95	84,62
AI331650A	WT397	R41 - R47 - R54 - F41 - F54	49,95	57,94
538 24 28 13	ZAMA	HG22	57,97	67,25
538 24 24 38	WYL176	HG63 - HG65	64,92	75,31
538 24 24 98	ZAMA	HG550	57,97	67,25



CILINDRO

Referencia	P.V.P. Euros	P.V.P. €+IVA	Mod. Partner
538 00 01 67	78,72	91,31	P33
530 03 87 49	91,94	106,65	350
530 07 15 79	60,28	69,92	351-370
530 01 25 50	41,25	47,85	352-401
530 06 99 40	92,69	107,52	365
530 06 99 41	99,16	111,55	405
530 07 12 55	98,91	114,74	420 - F5000
530 01 21 55	100,94	117,09	465
530 07 14 90	93,26	108,18	470 Antigua
530 07 14 91	66,81	77,50	470 Moderna
530 01 21 53	103,71	120,30	495
530 01 23 67	98,19	113,90	545
530 03 61 54	167,64	194,46	605



PISTÓN CPL

Referencia	P.V.P. Euros	P.V.P. €+IVA	Mod. Partner
538 00 00 53	29,06	33,71	
530 06 97 01	38,94	45,17	
530 06 96 04	29,06	33,71	
530 07 14 08	14,52	16,84	
530 06 99 44	40,08	46,50	
530 06 94 54	30,65	35,55	
530 06 97 19	29,06	33,71	
530 01 08 64	55,92	64,87	
530 06 95 48	52,87	61,32	
530 07 14 96	29,06	33,71	
530 01 08 62	87,14	101,08	
530 07 13 21	40,52	47,01	
530 06 95 49	56,80	65,89	



CILINDRO + PISTÓN

Referencia	P.V.P. Euros	P.V.P. €+IVA	Mod. Partner
506 01 06 07	145,27	168,51	400-410-411-B405
503 44 08 02	159,79	185,35	450-460-B450
538 24 85 00	115,19	133,62	461
503 62 55 02	167,05	193,77	490-510-511
503 96 84 71	164,14	190,40	500 (44 mm)
503 60 91 72	152,53	176,93	540-543 (46 mm)
538 24 87 66	122,74	142,38	610
503 99 92 71	213,53	247,70	7700
538 24 78 93	126,37	146,59	720
538 24 96 97	100,94	117,09	4200
538 24 96 98	102,41	118,80	4600
538 24 97 00	111,12	128,90	5200
538 24 77 01	100,08	116,09	B310
538 24 79 42	88,90	103,13	B341 (38 mm)
538 24 77 00	90,79	105,32	B341 (40 mm)
538 24 76 99	109,23	126,71	B400
538 24 88 06	110,55	128,24	B420
538 24 91 64	113,01	131,10	B422X
538 24 79 34	114,60	132,93	B470 - B4700 - B472X

PISTÓN CPL

Referencia	P.V.P. Euros	P.V.P. €+IVA	Mod. Partner
503 48 90 02	41,82	48,51	
503 44 10 02	44,02	51,07	
538 24 72 58	36,89	42,80	
503 62 56 02	46,20	53,59	
503 45 77 01	46,20	53,59	
503 60 81 71	48,36	56,09	
538 22 75 11	48,22	55,94	
503 42 08 02	58,39	67,73	
538 22 95 43	36,89	42,80	
538 24 97 09	34,14	39,61	
538 24 97 10	35,88	41,62	
538 24 97 12	46,62	54,08	
538 24 00 01	31,68	36,75	
538 23 57 99	29,63	34,38	
538 24 72 56	39,36	45,66	
538 24 72 57	35,60	41,29	
538 24 88 07	35,60	41,29	
538 24 88 07	35,60	41,29	
538 24 72 58	36,89	42,80	

CORTACÉSPEDES MANUALES

Modelo	Referencia	Corte	Descarga	Recogedor	Sistema de corte	Peso	P.V.P. Euros	P.V.P. €+IVA	
	EXCLUSIVE 9649140-70 Novedad	Ancho 40 cm Alturas 4 12/34 mm	Trasero	Opcional	Helicoidal	8,4 Kg	79,31	92,00	
	964901001	Recogedor cortacéspedes manuales						28,58	33,15

CORTACÉSPEDES CON MOTOR ELÉCTRICO SIN TRACCIÓN

Modelo	Referencia	Corte	Peso	Recogedor	Carcasa	Motor	P.V.P. Euros	P.V.P. €+IVA
	1340 E 9538783-21	Ancho 40 cm Alturas 3 25/55 mm Sup. Rec. 500 m ²	16,5 Kg	40 L	ABS	1.300 W	147,41	171,00
	1746E 9538765-60	Ancho 46 cm Alturas 5 30/70 mm Sup. Rec. 1.000 m ²	27 Kg	50 L	Acero	1.700 W	197,41	229,00

CORTACÉSPEDES 4 TIEMPOS SIN TRACCIÓN

Modelo	Referencia	Corte	Peso	Recogedor	Carcasa	Motor	P.V.P. Euros	P.V.P. €+IVA
	P3540P 9538781-01	Ancho 40 cm Alturas 3 22/51mm Sup. Rec. 800 m ²	26 Kg	40 L	ABS	B&S 3,5 HP	270,69	314,00
	4040S 9538780-64	Ancho 40 cm Alturas 5 22/70mm Sup. Rec. 800 m ²	27 Kg	50 L	Acero	B&S 4,0 HP	285,34	331,00

CORTACÉSPEDES 4 TIEMPOS CON TRACCIÓN TRASERA

Modelo	Referencia	Corte	Peso	Recogedor	Carcasa	Motor	P.V.P. Euros	P.V.P. €+IVA
	4046 SD 9538781-41	Ancho 46 cm Alturas 5 22/70 mm Sup. Rec. 1.200 m ²	30 Kg	50 L	Acero	B&S 4,0 HP	368,97	428,00
	4546 SDX 9620000-38	Ancho 46 cm Alturas 6 Centralizadas 25/70 mm Sup. Rec. 1.500 m ²	40 Kg	53 L	Acero	B&S 4,5 HP	439,66	510,00

CORTACÉSPEDES 4 TIEMPOS CON TRACCIÓN TRASERA

Modelo	Referencia	Corte	Peso	Recogedor	Carcasa	Motor	P.V.P. Euros	P.V.P. €+IVA
	6053 CD 9620000-32	Ancho 53 cm Alturas Centralizadas 30/70 mm Sup. Rec. 2.000 m ²	43 Kg	60 L	Aluminio	B&S 6 HP Quantum XTL	595,69	691,00
	6051 CDTX 9538780-95	Ancho 51 cm Alturas 6 30/70 mm Centralizadas Kit Biotritrador Sup. Rec. 2.000 m ²	45 Kg	53 L	Aluminio	B&S XM 60TNM Touch'n Mow	765,52	888,00

CORTACÉSPEDES 4 TIEMPOS CON TRACCIÓN DELANTERA

Modelo	Referencia	Corte	Peso	Recogedor	Carcasa	Motor	P.V.P. Euros	P.V.P. €+IVA
	5553 D 9614101-53 Novedad	Ancho 53 cm Alturas 5 25/82 mm Kit Biotritrador Sup. Rec. 2.000 m ²	42 Kg	60 L	Acero	Honda GCV160 5,5 HP	516,38	600,00
	6553 D 9614101-52	Ancho 53 cm Alturas 5 25/82 mm Kit Biotritrador Sup. Rec. 2.000 m ²	41,3 Kg	60 L	Acero	B&S 6,5 HP	477,59	554,00

CUCHILLAS CORTACÉSPEDES PARTNER

	Modelos	Referencia	Denominación	Agujero	P.V.P. Euros	P.V.P. €+IVA
	146EL-146-146CD-147CD	531 02 01 33	Cuchilla 46 cm	10,2 mm	14,76	17,12
	148CD	531 02 01 31	Cuchilla 48 cm	10,2 mm	14,76	17,12
	150-150D	531 02 01 34	Cuchilla 50 cm	16 mm	12,39	14,37
	155D	532 10 35 24	Cuchilla 55 cm	8,5 mm	21,91	25,42
	153CD	516 49 43 04	Cuchilla 53 cm	10,2 mm	19,60	22,74
	RE370 - 371EL	512 78 52 60	Cuchilla 37 cm	16 mm	18,08	20,98
	421EL-421SEL-431-431SPD	511 92 23 00	Cuchilla 42 cm	16 mm	24,20	28,07
	461SPD	531 02 10 67	Cuchilla 45 cm	16 mm	19,12	22,18
	471SPD	511 88 06 00	Cuchilla 46 cm	16 mm	20,26	23,50
	491SPD-491SPD2	531 02 10 75	Cuchilla 48 cm	16 mm	27,85	32,31
	1033E	531 20 60 99	Cuchilla 33 cm	17 mm	6,38	7,40
	1340E-3540P	953 87 64 66	Cuchilla 40 cm	17 mm	9,77	11,33
	3540S	531 20 53 49	Cuchilla 40 cm	17 mm	7,99	9,26
	4040S	531 21 16 53	Cuchilla 40 cm	17 mm	7,99	9,26
	1746E-3546S-4046SD-4046SDE 4046SDX-4546SDX-4546SDXE	531 21 16 52	Cuchilla 46 cm	17 mm	12,23	14,19
	6053CD	531 21 16 46	Cuchilla 53 cm	17 mm	15,53	18,02
	6053CD con aleta	531 21 36 95			23,45	27,20
	531PD-6553CMY	532 17 50 52	Cuchilla 53 cm	17 mm	21,41	24,83
	4553SDX-6053CDTX	531 21 10 28	Cuchilla 53 cm	17 mm	7,66	8,88
	6051CDTX	531 20 65 46	Cuchilla 55 cm	17 mm	12,47	14,47

CORREAS CORTACÉSPEDES PARTNER



Modelos	Referencia	Denominación	P.V.P. Euros	P.V.P. €+IVA
146CD-147CD	531 02 06 62	Correa	9,42	10,92
148CD - 148CDE	531 02 06 57	Correa	10,32	11,97
150D	532 11 19 24	Correa	12,23	14,19
153CD	516 92 46 00	Correa	10,19	11,82
155D	532 85 00 28	Correa	15,80	18,32
431SPD	513 91 09 00	Correa	9,88	11,46
461SPD	513 91 09 03	Correa	9,42	10,92
471SPD-491SPD-491SPD2	513 91 09 01	Correa	17,58	20,39
4046SD-4046SDX-4046SDE 4546SDX-4546DXE	531 20 72 80	Correa Z27	10,19	11,82
4553SDX	531 20 61 76	Correa Z19 1/2	5,37	6,23
531PD	532 16 08 16	Correa	15,05	17,46
6053CD-6053CDTX	531 20 73 75	Correa Z30 3/4	10,71	12,43
6553CMY	532 16 97 78	Correa	12,23	14,19
6051CDTX	531 20 67 01	Correa	10,71	12,43

CORREAS CORTACÉSPEDES MODELOS FLYMO



Micro Compact 300 Plus P.N. 9633095-86	513 05 44 00	Correa J4	8,67	10,05
Turbo Lite 400 P.N. 9634100-86	513 78 72 00	Correa J5	10,56	12,25
Turbo Compact 330 P.N. 9633302-86 Turbo Compact 380 P.N. 963 3850-86	512 73 33 00	Correa J5	19,38	22,48
Power Compact 330 P.N. 963302-86 Power Compact 400 P.N. 9644403-86	513 06 47 00	Correa	13,00	15,08

CABLES CORTACÉSPEDES PARTNER



Modelos	Referencia	Denominación	P.V.P. Euros	P.V.P. €+IVA
146CD	517 81 00 32	Mando y cable gas	11,18	12,96
	513 86 49 00	Cable tracción	15,05	17,46
	517 81 00 43	Cable freno-motor	14,01	16,26
147CD	517 81 00 32	Mando y cable gas	11,18	12,96
	517 81 00 44	Cable tracción	11,20	12,99
	517 81 00 46	Cable freno-motor	14,01	16,26
148CD	531 02 06 56	Mando y cable gas	11,20	12,99
	516 82 22 02	Cable tracción	14,78	17,15
	517 81 00 47	Cable variador	11,20	12,99
153CD	531 02 06 56	Mando y cable gas	11,20	12,99
	516 82 43 02	Cable tracción	12,47	14,47
	516 82 50 02	Cable variador	12,74	14,78
431	513 86 46 01	Cable freno-motor	9,00	10,44
431SPD	513 86 30 00	Cable tracción	16,26	18,86
	513 05 39 00	Cable freno-motor	7,66	8,88
461SPD-471SPD	513 86 30 00	Cable tracción	16,26	18,86
	513 86 68 01	Cable freno-motor	8,58	9,95
	513 90 34 00	Cable variador (sólo 471SPD)	28,34	32,87
491SPD	512 78 92 02	Cable gas	12,23	14,19
	513 94 85 00	Cable tracción	13,24	15,36
	513 05 39 00	Cable freno-motor	7,66	8,88
491SPD2	513 90 25 00	Cable gas	28,75	33,35
	513 86 61 00	Cable tracción	15,25	17,69
	513 86 46 01	Cable freno-motor	9,00	10,44
	513 90 34 00	Cable variador	28,34	32,87
3540P	531 20 64 38	Cable freno-motor	4,36	5,05
3540S - 4040S	531 20 60 26	Cable freno-motor	3,92	4,54
4046SDE 6053CD	531 21 11 41	Cable gas	6,38	7,40
	531 20 60 00	Cable tracción	9,42	10,92
	531 21 34 34	Cable freno-motor	9,68	11,23
4046 SD - 4046SDX	531 20 61 91	Cable tracción	5,08	5,90
	531 21 34 34	Cable freno-motor	9,68	11,23
4546SDX	531 20 62 10	Cable gas	9,94	11,54
	531 21 18 47	Cable tracción	5,96	6,92
	531 21 34 34	Cable freno-motor	9,68	11,23
4546SDXE	531 21 11 41	Cable gas	6,38	7,40
	531 21 11 43	Cable tracción	6,38	7,40
	531 21 11 45	Cable freno-motor	6,38	7,40
4553SDX	531 20 50 96	Cable gas	5,52	6,41
	531 21 18 47	Cable tracción	5,96	6,92
	531 21 34 34	Cable freno-motor	9,68	11,23
6050CDTX	531 21 14 79	Mando + Cable freno - P/M	19,87	23,04
	531 20 62 98	Cable tracción	10,19	11,82
531PD	532 18 21 54	Cable gas	13,64	15,82
	532 18 76 26	Cable tracción	17,84	20,70
	532 13 31 07	Cable freno-motor	17,58	20,39
6051CDTX	531 21 14 79	Mando + Cable freno - P/M	19,87	23,04
	531 21 23 69	Cable tracción	9,17	10,64
6553CMY	532 70 04 17	Cable gas	13,00	15,08
	532 18 91 82	Cable tracción	24,84	28,81
	532 13 31 07	Cable freno-motor	17,58	20,39

RUEDAS CORTACÉSPEDES PARTNER

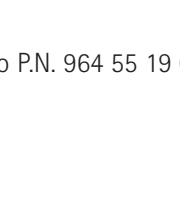



Modelo	Referencia	Denominación	P.V.P. Euros	P.V.P. €+IVA
146-146C-146EL	516 82 70 09	Delanteras y traseras	12,19	14,14
146CD-147CD	516 82 70 09	Delanteras	12,19	14,14
	517 81 00 21	Trasera izquierda	13,07	15,16
	517 81 00 22	Trasera derecha	13,07	15,16
150	532 80 00 60	Delanteras y traseras ø 175	6,82	7,91
	532 80 02 20	Delanteras y traseras ø 195	7,77	9,01
150D	532 85 06 90	Delanteras	17,86	20,72
	532 14 84 40	Traseras	8,80	10,21
153CD	516 82 38 09	Delanteras	19,32	22,41
	516 82 49 00	Traseras	26,86	31,16
155D	532 14 84 40	Delanteras	8,80	10,21
	532 85 07 07	Traseras	22,07	25,60
371EL	513 86 31 00	Delanteras	11,20	12,99
	513 86 35 00	Traseras	11,20	12,99
421EL-421SEL-431	513 98 05 01	Delanteras y traseras	13,38	15,52
431SPD	513 98 06 01	Delanteras	21,41	24,83
	513 86 37 01	Traseras	7,77	9,01
461SPD	513 98 06 01	Delanteras	21,41	24,83
	513 86 40 02	Traseras	17,14	19,88
471SPD-491SPD2	513 97 08 00	* Delanteras	22,66	26,29
	513 98 05 01	Delanteras	13,38	15,52
	513 86 40 02	Traseras	17,14	19,88
491SPD	513 97 08 00	Delanteras	22,66	26,29
	513 97 09 00	Traseras	26,99	31,31
1033E	531 20 61 21	Delanteras ø 130	1,28	1,48
	531 20 61 12	Traseras ø 160	1,54	1,79
1340E-3540P	531 20 64 01	Delanteras y traseras ø 160	3,81	4,42
1746E - 3540S - 4040S	531 20 60 18	Delanteras y traseras ø 160	3,04	3,52
4046SDE	531 20 50 29	Delanteras ø 170	4,73	5,49
	531 21 05 35	Traseras ø 190	5,59	6,48
4046SDX	531 21 05 36	Delanteras ø 170	4,64	5,38
	531 20 43 65	Traseras ø 190	5,65	6,56
6053CD	531 21 05 36	Delanteras ø 170	4,64	5,38
	531 21 05 37	Traseras ø 210	9,72	11,28
4046SD	531 20 50 29	Rueda delantera	4,73	5,49
	531 21 09 12	Rueda trasera	5,24	6,07
4546SDX - 4546SDX	531 21 07 03	Rueda delantera	5,85	6,79
	531 21 06 13	Rueda trasera	3,81	4,41
4553SDX - 6053CDTX	531 21 07 03	Rueda delantera	5,85	6,79
	531 21 07 26	Rueda trasera	8,93	10,36
531PD	532 14 35 93	Rueda delantera	21,93	25,44
	532 18 07 53	Rueda trasera	28,17	32,69
6553CMY	532 18 07 67	Rueda delantera	17,58	20,39
	532 18 17 85	Rueda trasera	37,77	43,82

(*) Sólo P.N. 964 55 19 00

SOPLADOR-ASPIRADOR CON MOTOR 2 TIEMPOS

Modelo	Referencia	Cilindrada Potencia	Peso	Características	P.V.P. Euros	P.V.P. €+IVA
	BV25 9527154-37	25 cc 0,7 Kw 0,9 HP	4,6 Kg	Saco 45 litros Velocidad aire 0-325 Km/h. Volumen de aspiración: 10,9 (m ³ /min.) Cuchillas metálicas que reducen 16:1 Encendido electrónico Nivel potencia cústica: 112 db	180,17	209,00

CORTASETOS CON MOTOR 2 TIEMPOS

Modelo	Referencia	Cilindrada Potencia	Peso	Características	P.V.P. Euros	P.V.P. €+IVA
	HG550 9539005-93	25 cc 0,7 Kw 0,9 HP	4,7 Kg	Cuchillas de acero de doble corte Largo de cuchillas 55 cm Separación entre cuchillas: 18 mm Con sistema antivibración	238,79	277,00
	HG-65 9539005-23	25 cc 0,7 Kw 0,9 HP	5,5 Kg	Cuchillas de acero de doble corte Largo de cuchillas: 60 cm Separación entre cuchillas: 27 mm Con sistema antivibración	283,62	329,00

TRACTORES CORTACÉSPEDES

Modelo	Referencia	Características	P.V.P. Euros	P.V.P. €+IVA
	P6562E 9538781-50	Motor/Potencia: B&S / 6,5 HP Ancho de corte: 62 cm Nº de cuchillas: 1 Descarga: trasera Transmisión: mecánica Velocidades: 5 adelante - 1 atrás Alturas de corte: 5-30 a 90 mm Embrague cuchillas: manual Recogedor: 150 litros Tipo de chasis: acero Arranque eléctrico Superficie recomendada: 3.000m ² Peso: 125 kg	1.556,03	1.805,00
	P105B67 9538781-52	Motor/Potencia: B&S / 10,5 HP Ancho de corte: 67 cm Nº de cuchillas: 1 Descarga: trasera Transmisión: mecánica Velocidades: 5 adelante - 1 atrás Alturas de corte: 30-90 mm Embrague cuchillas: manual Recogedor: 130 litros Tipo de chasis: acero Arranque eléctrico Superficie recomendada: 4.000m ² Peso: 145 kg	1.791,38	2.078,00

TRACTORES CORTACÉSPEDES

Modelo	Referencia	Características	P.V.P. Euros	P.V.P. €+IVA
	P12597 9601102-39	Motor/Potencia: B&S / 12,5 HP Ancho de corte: 92 cm Nº de cuchillas: 2 Descarga: lateral Transmisión: mecánica Velocidades: 4 adelante - 1 atrás Alturas de corte: 38-100 mm Embrague cuchillas: manual Recogedor opcional: 230 litros Tipo de chasis: acero reforzado Arranque eléctrico Superficie recomendada: 6.000m ² Peso: 275 kg	1.719,83	1.995,00
	P13592HRB 9616101-74 Novedad	Motor/Potencia: B&S / 13,5 HP Ancho de corte: 92 cm Nº de cuchillas: 2 Descarga: trasera Transmisión: hidrostática Alturas de corte: 38-102 mm Embrague cuchillas: manual Recogedor: 210 litros Tipo de chasis: acero reforzado Arranque eléctrico Superficie recomendada: 6.000m ² Peso: 295 kg	2.136,21	2.478,00
	P155107HRB 9606101-76	Motor/Potencia: B&S / 15,5 HP Ancho de corte: 107 cm Nº de cuchillas: 2 Descarga: trasera Transmisión: hidrostática Alturas de corte: 38-102 mm Embrague cuchillas: manual Recogedor: 210 litros Tipo de chasis: acero reforzado Arranque eléctrico Superficie recomendada: 7.000m ² Peso: 295 kg	3.000,00	3.480,00
	M185B107HRBK 9606100-97 Novedad	Motor/Potencia: B&S / 18,5 HP Ancho de corte: 107 cm Nº de cuchillas: 2 Descarga: trasera Transmisión: hidrostática Alturas de corte: 38-102 mm Embrague cuchillas: manual Recogedor: 210 litros Tipo de chasis: acero reforzado Arranque eléctrico Superficie recomendada: 8.000m ² Peso: 295 kg	3.250,00	3.770,00
	P200107HBR 9606101-78	Motor/Potencia: B&S bicilíndrico / 20 HP Ancho de corte: 107 cm Nº de cuchillas: 2 Descarga: trasera Transmisión: hidrostática Alturas de corte: 38-102 mm Embrague cuchillas: manual Recogedor: 210 litros Tipo de chasis: acero reforzado Arranque eléctrico Superficie recomendada: 10.000m ² Peso: 300 kg	3.400,86	3.945,00

ACCESORIOS PARA TRACTORES CORTACÉSPEDES DESCARGA TRASERA

	Modelos	Referencia	Denominación	Ancho corte pulgadas/cm	P.V.P. Euros	P.V.P. €+IVA
 1	125 CRDA P.N. 9541200-33 P.N. 9541200-23	532 17 00 37	(1) Cuchilla SX	36"/92cm	22,92	26,59
		532 17 00 38	(2) Cuchilla DX	36"/92cm	22,92	26,59
		531 02 10 48	Correa cuchillas	36"/92cm	48,42	56,17
		531 02 10 46	Correa tracción	36"/92cm	43,05	49,94
 2	145 HCRD P.N. 9541200-24	532 17 00 37	(1) Cuchilla SX	36"/92cm	22,92	26,59
		532 17 00 38	(2) Cuchilla DX	36"/92cm	22,92	26,59
		531 02 10 48	Correa cuchillas	36"/92cm	48,42	56,17
		531 02 10 47	Correa tracción	36"/92cm	43,05	49,94
 3	145 HCRD P.N. 9541200-34	532 17 54 50	(3) Cuchilla DX	42"/107cm	28,53	33,10
		532 17 54 51	(4) Cuchilla SX	42"/107cm	25,48	29,55
		532 40 20 09	Correa cuchillas	42"/107cm	46,95	54,46
		531 02 10 47	Correa tracción	42"/107cm	43,05	49,94
 4	145 HCRD P.N. 9647776-00 P.N. 9647728-00 P.N. 9647720-01 P.N. 9606100-23	532 18 05 83	(5) Cuchilla SX sup.	42"/107cm	26,51	30,75
		532 18 04 24	(6) Cuchilla SX inf.	42"/107cm	26,51	30,75
		532 18 05 84	(7) Cuchilla DX sup.	42"/107cm	26,51	30,75
		532 18 04 25	(8) Cuchilla DX inf.	42"/107cm	26,51	30,75
 5	180 HCRD P.N. 9647729-00 P.N. 9647721-00	532 40 20 09	Correa cuchillas	42"/107cm	46,95	54,46
		532 17 01 40	Correa tracción	42"/107cm	39,00	45,24

ACCESORIOS PARA TRACTORES CORTACÉSPEDES SALIDA LATERAL

 1	12-92 P.N. 9647715-01	531 02 06 72	(1) Cuchilla recogedor	36"/92cm	14,76	17,12
		531 02 06 71	(2) Cuchilla triturar	36"/92cm	17,86	20,72
	11-92 P.N. 9647707-00	532 18 02 13	Correa cuchillas	36"/92cm	31,86	36,95
		532 13 82 55	Correa tracción	36"/92cm	45,85	53,18
 2	12-90 E P-115	531 02 06 72	(1) Cuchilla recogedor	36"/92cm	14,76	17,12
		531 02 06 71	(2) Cuchilla triturar	36"/92cm	17,86	20,72
		532 13 12 64	Correa cuchillas	36"/92cm	16,32	18,94
		531 02 06 73	Correa tracción	36"/92cm	32,60	37,82
 1	12-90 EH 13-90 EH	531 02 06 72	(1) Cuchilla recogedor	36"/92cm	14,76	17,12
		531 02 06 71	(2) Cuchilla triturar	36"/92cm	17,86	20,72
		532 13 12 64	Correa cuchillas	36"/92cm	16,32	18,94
		531 02 06 74	Correa tracción	36"/92cm	26,99	31,31
 2	12-95 E	532 13 84 97	(1) Cuchilla recogedor 36"	38"/97cm	10,82	12,56
		532 13 41 48	(2) Cuchilla triturar 36"	38"/97cm	10,76	12,48
		531 02 06 70	Correa cuchillas	38"/97cm	32,60	37,82
		532 12 59 07	Correa tracción	38"/97cm	32,60	37,82

(1) Cuchilla con aleta para recoger
(2) Cuchilla plana para triturar

DX= Derecha / SX= Izquierda

ACCESORIOS PARA TRACTORES CORTACÉPES SALIDA LATERAL

Modelos	Referencia	Denominación	P.V.P. Euros	P.V.P. €+IVA
 1 12-100 E	533 30 90 70	Cuchilla recogedor 40"	32,87	38,13
	533 31 33 16	Cuchilla triturar 40"	32,10	37,23
	533 04 80 44	Correa cuchillas	38,46	44,61
	533 30 32 41	Correa tracción	32,60	37,82
12,5-105 E	531 02 06 63	Cuchilla recogedor 42"	16,68	19,34
	531 02 06 64	Cuchilla triturar 42"	17,14	19,88
	531 02 06 68	Correa cuchillas	38,24	44,35
	532 13 82 55	Correa tracción	45,85	53,18
 2 12,5-105 EH	531 02 06 63	Cuchilla recogedor 42"	16,68	19,34
	531 02 06 64	Cuchilla triturar 42"	17,14	19,88
	531 02 06 68	Correa cuchillas	38,24	44,35
	532 13 75 89	Correa tracción	32,60	37,82
14-105 E	531 02 06 63	Cuchilla recogedor 42"	16,68	19,34
	531 02 06 64	Cuchilla triturar 42"	17,14	19,88
	531 02 06 69	Correa cuchillas	34,65	40,19
	532 13 82 55	Correa tracción	45,85	53,18
 14-105 EH	531 02 06 63	Cuchilla recogedor 42"	16,68	19,34
	531 02 06 64	Cuchilla triturar 42"	17,14	19,88
	531 02 06 69	Correa cuchillas	34,65	40,19
	531 02 06 67	Correa tracción	35,66	41,37
15-105 E	531 02 06 63	Cuchilla recogedor 42"	16,68	19,34
	531 02 06 64	Cuchilla triturar 42"	17,14	19,88
	531 02 06 70	Correa cuchillas	32,60	37,82
	532 13 82 55	Correa tracción	45,85	53,18
 15-105 EH 16-105 EH	531 02 06 63	Cuchilla recogedor 42"	16,68	19,34
	531 02 06 64	Cuchilla triturar 42"	17,14	19,88
	531 02 06 70	Correa cuchillas	32,60	37,82
	531 02 06 67	Correa tracción	35,66	41,37
P160 H	531 02 06 63	Cuchilla recogedor 42"	16,68	19,34
	531 02 06 64	Cuchilla triturar 42"	17,14	19,88
	531 02 06 70	Correa cuchillas	32,60	37,82
	531 02 10 43	Correa tracción	27,26	31,62

(1) Cuchilla con aleta para recoger
 (2) Cuchilla plana para triturar

KITS DE TRITURAR PARA TRACTORES CON DESCARGA LATERAL



Ancho de corte	Referencia	Modelos	P.V.P. Euros	P.V.P. €+IVA
38" 96 cm	954 04 04 31	12-95E	97,39	112,98
36" 92 cm	954 04 04 91	12-90E / 13-90E P115 / P11-92	85,01	98,61
42" 107 cm	954 04 04 41	14-105EH / 15-105EH 16-105EH	85,01	98,61

ACCESORIOS TRACTORES DESCARGA TRASERA



Modelos	Referencia	Denominación	P.V.P. Euros	P.V.P. €+IVA
42"	(1) 954 12 00 92	Tapón de triturar	79,00	91,64
36" y 42"	(2) 954 12 00 91	Deflector	120,96	140,31

ACCESORIOS TRACTORES

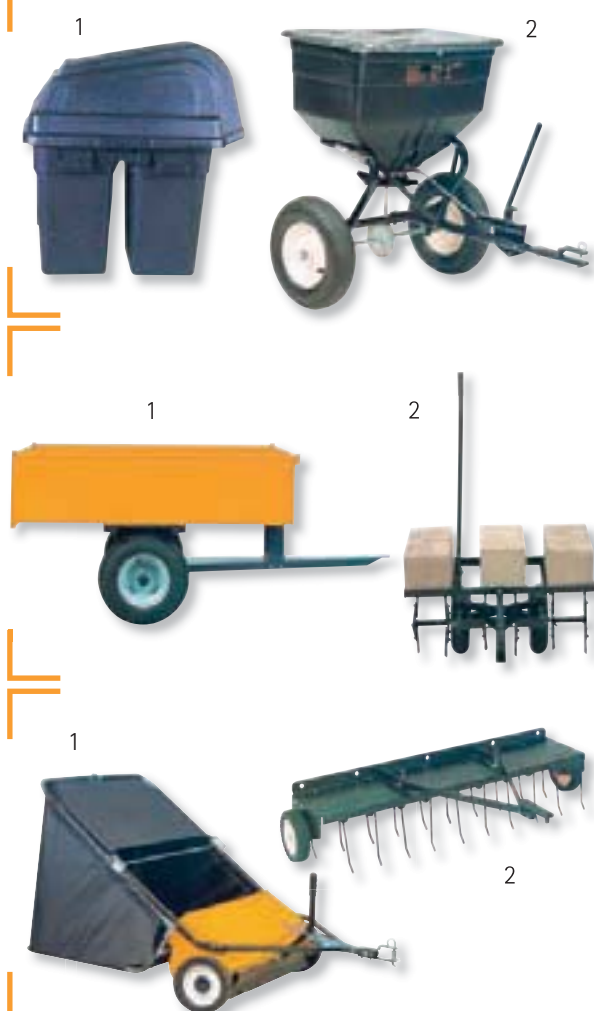

Mod.	Referencia	Denominación	P.V.P. Euros	P.V.P. €+IVA
12-92	(1) 964 77 50 00	Recogedor 230 litros	286,75	332,63
Todos	(2) 531 02 57 05	Abonadora esparcedora 75 kg	218,72	253,72
Todos	(1) 531 02 06 12	Remolque tractor "Kova" 225 kg	379,57	440,30
Todos	(1) 531 02 57 01	Remolque tractor "Agrifer"	190,06	220,47
Todos	(2) 531 02 57 02	Aireador de césped	209,18	242,64
Todos	(1) 531 02 57 04	Barredora recogedor 96 cm	447,94	519,61
Todos	(2) 531 02 57 03	Escarificador hierba 102 cm	132,77	154,01

CUBIERTAS PARA TRACTORES



Medidas	Referencia	Denominación	P.V.P. Euros	P.V.P. €+IVA
13x5-6	532 12 34 10	Cubierta delantera	53,31	61,83
15x6-6	533 30 11 40	Cubierta delantera	62,30	72,27
16x6,5-8	532 10 62 30	Cubierta trasera	83,09	96,39
16x7,5-8	532 12 34 11	Cubierta trasera	91,65	106,32
18x8,5-8	532 13 27 03	Cubierta trasera	93,54	108,51
18x9,5-8	532 12 20 74	Cubierta trasera	88,75	102,95
20x8-8	532 13 84 68	Cubierta trasera	114,47	132,78
20x10-8	532 12 20 82	Cubierta trasera	104,87	121,65

CÁMARAS PARA TRACTORES



11X4-4	531 20 85 75	Cámara	14,81	17,17
12x4-6	531 02 00 71	Cámara delantera	36,32	42,13
13X5-6/15x6-6	532 05 99 04	Cámara delantera	18,15	21,05
16x6,5-8	532 00 81 34	Cámara trasera	19,91	23,10
18/20x8,5/9,5-8	532 00 71 52	Cámara trasera	23,10	26,80
20x10-8	531 02 01 87	Cámara trasera	35,88	41,62

BATERÍAS



Modelos	Referencia	Denominación	P.V.P. Euros	P.V.P. €+IVA
(1) Tractores cortacéspedes	506 78 88 01	12 v 24 Ah (sin ácido) 185x125x175 mm	56,00	64,96
(2) 146 E	516 84 41 02	12 v 6,5 Ah	64,97	75,38
(3) 4046SDE-146CDE 147CDE-148CDE-153CDE	531 21 34 47	12 v 2,5 Ah	35,66	41,37
(4) CT250-CT250X	513 94 01 00	12 v 5 Ah	43,82	50,84
(2) P6265E	531 21 23 01	Batería Tractor	77,97	90,44

CARGADORES DE BATERÍAS



(1) 146E-146CDE 148CDE-153CDE	513 91 96 02	12 v 200 mA	49,17	57,04
(2) 4046SDE	531 20 09 04	12 v 100 mA	24,40	28,30
(3) CT250-CT250X	513 83 04 01	13,2 v 490 mA	36,19	41,98

REBORDEADOR CON MOTOR DE GASOLINA

Modelo	Referencia	Cilindrada Potencia	Peso*	Accesorios	P.V.P. Euros	P.V.P. €+IVA
	Colibri II+ 9527154-59	25 cc 0,8 Kw 0,9 HP	4,4 Kg	Empuñadura simple Cabezal de corte 2 hilos semiautomático	125,00	145,00

DESBROZADORES CON MOTOR DE GASOLINA

Modelo	Referencia	Cilindrada Potencia	Peso*	Accesorios	P.V.P. Euros	P.V.P. €+IVA
	B-251 9539002-51	25 cc 0,9 HP 0,7 Kw	5,6 Kg	Empuñadura simple ajustable Cabezal de corte 2 hilos Disco 4 puntas Arnés	244,83	284,00
	B257L 9539007-69 Novedad Abril 2007	25 cc 0,9 HP 0,7 Kw	5,6 Kg	Empuñadura simple ajustable Cabezal de corte 2 hilos Disco 4 puntas Arnés	262,93	305,00

DESBRUZADORES CON MOTOR DE GASOLINA

Modelo	Referencia	Cilindrada Potencia	Peso*	Accesorios	P.V.P. Euros	P.V.P. €+IVA
	B-261 9539002-50	25 cc 0,9 HP 0,7 Kw	5,8 Kg	Empuñadura doble Cabezal de corte 2 hilos manual Disco 4 puntas Arnés doble	266,38	309,00
IMAGEN NO DISPONIBLE	B267 9539007-70 Novedad Marzo 2007	25 cc 0,9 HP 0,7 Kw	5,8 Kg	Empuñadura doble Cabezal de corte 2 hilos semiautomático Disco 4 puntas Arnés doble	276,72	321,00
	B407 9539007-80 Novedad	40 cc 2 HP 1,5 Kw	7,1 Kg	Empuñadura doble ajustable Cabezal de corte 2 hilos semiautom. Disco 4 puntas Arnés doble	346,55	402,00



DESBRUZADORES CON MOTOR DE GASOLINA

Modelo	Referencia	Cilindrada Potencia	Peso*	Accesorios	P.V.P. Euros	P.V.P. €+IVA
IMAGEN NO DISPONIBLE	BA437BT 9539007-82 Novedad	43 cc 2,2 HP 1,6 Kw	8,7 Kg	Empuñadura doble ajustable Cabezal de corte 2 hilos semiautomática Disco 4 puntas Arnés Profesional	452,59	525,00
	B-472 X 9539005-19	46 cc 2,5 HP 1,8 Kw	8,7 Kg	Empuñadura doble ajustable Cabezal de corte 2 hilos manual Disco 4 puntas Arnés Profesional	474,14	550,00
IMAGEN NO DISPONIBLE	BA497BT 9539007-86 Novedad Abril 2007	49 cc 2,7 HP 2 Kw	8,7 Kg	Empuñadura doble ajustable Cabezal de corte 2 hilos semiautomática Disco 4 puntas Arnés Profesional	487,07	565,00

DES BROZADOR CON MOTOR DE GASOLINA "4 TIEMPOS MIX"

Modelo	Referencia	Cilindrada Potencia	Peso*	Accesorios	P.V.P. Euros	P.V.P. €+IVA
	B 522 M 9539005-20	52 cc 2,7 HP 2,0 Kw	9,4 Kg	Manillar doble ajustable Disco 4 puntas Cabezal hilo 2 salidas manual Arnés profesional	568,10	659,00

DES BROZADORES PROFESIONALES CON MOTOR DE GASOLINA

	B 405 9682311-06	40,2 cc 2,4 HP 1,8 Kw	8,6 Kg	Manillar doble ajustable Arnés doble profesional Disco 3 puntas Cabezal hilo 2 salidas presión	568,10	659,00
	B 450 G 9682321-03	44,3 cc 2,7 HP 2,0 Kw	8,6 Kg	Manillar doble ajustable Arnés doble profesional Disco 3 puntas Cabezal hilo 2 salidas presión	660,34	766,00

DES BROZADOR PROFESIONAL DE MOCHILA

	B422XBP 9539003-97	42 cc 2,2 HP 1,6 Kw	8,8 Kg	Empuñadura simple Disco 4 puntas Cabezal hilo 2 salidas Arnés Profesional	499,14	579,00
---	------------------------------	---------------------------	--------	---	--------	--------

TRIMMYS MODELOS PARTNER

	Modelos	Figura	Referencia	Grosor hilo	Tipo	P.V.P. Euros	P.V.P. €+IVA
	MaxiTrim 900	1	538 24 24 48	1,5 mm	Presión	11,20	12,99
	Colibrí 25	2	530 09 58 46	2 mm	Presión	24,35	28,25
	Colibrí Colibrí Plus-TC230	3	530 04 74 98	1,5 mm	Presión 5/16 Rh	19,91	23,10
	B250	4	531 00 92 68	2,4 mm	Manual M12	11,57	13,42
	B322 - T321	5	952 71 55 09	2,4 mm	Presión 3/8 Rh ø 8mm	15,00	17,40
	B325	6	952 71 55 81	2,4 mm	Presión 3/8 Lh	19,90	23,08
	B245-B246 T240	1	952 71 55 88	2,4 mm	Presión 5/16 Rh	19,43	22,54
	B251-B261-B341	7	531 02 50 01	2,4 mm	Presión 3/8" L 5/16" R 3/8 R M10x1,25 L	11,90	13,80
	B260-B310-B341 B400-B420-B470 B4700-B422X B472X-B522M	8	531 02 50 02	3,0 mm	Presión P35	11,90	13,80
	B380 - B405 B440 - B450G	9	502 26 08 12	3,3 mm	Manual SII M12	35,73	41,44
		10	531 00 92 26	3,3 mm	Auto 55 M12 Presión Auto.	50,40	58,47
		11	531 00 92 69	2,4 mm	T35 M12 Presión Auto	13,90	16,12
		12	502 13 87 02	2,4 mm	Fix Manual	30,87	35,80

TRIMMYS MODELOS CAMON



Modelos	Referencia	Grosor hilo	Tipo	P.V.P. Euros	P.V.P. €+IVA
T24 (1)	AI723810	2,0 mm	Trimmy presión M8x1,25 (F)	12,00	13,92
EK28 - C26M (1)	AI723430	2,4 mm	Trimmy presión M10x1 (F)	11,00	12,76
R29 R41 (2)	AI720670	2,4 mm	Trimmy manual M10x1 (F)	9,00	10,44
R54 F41 (3)	AI720980	2,4 mm	Trimmy manual 3 salidas	12,00	13,92
F54 C34M (4)	AI722540	2,4 mm	Trimmy presión M10x1 (F)	12,00	13,92
P410M (4)	AI722550	3,0 mm	Trimmy presión M10x1,25 (F)	11,90	13,80

TRIMMY UNIVERSAL



Todos	AI20056	3,0 mm	Multifilo aluminio 4 hilos □ 3x330 mm	17,25	20,01
	AI724800	3,0 mm	Blister 40 hilos □ 3x330 mm Repuesto multifilo	3,86	4,48

CABEZALES DE ALUMINIO "NYLSAW" UNIVERSALES



Referencia	Denominación	P.V.P. Euros	P.V.P. €+IVA
AI752950	Cabezal Aluminio "Speed" 2 hilos	29,90	34,68
AI752960	Cabezal Aluminio "Speed" 4 hilos	37,95	44,02
AI752970	Cabezal Aluminio "Speed" 6 hilos	36,90	42,80

DONUT BOBINAS NYLON SIERRA "NYLSAW"



Referencia	Medidas	P.V.P. Euros	P.V.P. €+IVA
AI544740	37 mts. ø 3 mm.	12,00	13,92
AI544750	27 mts. ø 3,5 mm.	12,00	13,92
AI544760	21 mts. ø 4 mm.	12,00	13,92
AI544770	10 mts. ø 4,5 mm.	12,00	13,92

COPAS DE APOYO MODELOS PARTNER

Modelos	Referencia	Tipo	P.V.P. Euros	P.V.P. €+IVA
B260-B261 B310-B341 B400-B420 B470-B4700 B422X-B472X	538 23 65 96	(1) Campana metálica ø 10 mm	2,62	3,04
	538 04 08 09	(2) Copa de apoyo con rodamiento	15,25	17,69
B380 B405 B440 B450G	502 07 15 01	(3) Campana metálica ø 12 mm	3,30	3,83
	502 15 70 02	(4) Copa de apoyo con rodamiento	20,95	24,30
	503 90 18 02	(5) Copa de apoyo fija ø 26 mm	6,18	7,17

COPAS DE APOYO MODELOS CAMON

R29-R41-R54 F41-F54	AI510470	Campana metálica ø 10 mm	2,05	2,38
------------------------	----------	-----------------------------	------	------

TRIMMY P25 CON 4 ADAPTADORES: 3/8"L, 5/16"R, 3/8"R, M10x1,25L

Referencia	Denominación	P.V.P. Euros	P.V.P. €+IVA
531025001 (1)	P25 Trimmy presión completo	11,90	13,80
537419302 (2)	Carcasa superior P25	5,24	6,08
537338901 (3)	Adaptador P25	5,90	6,84
537338801 (4)	Muelle P25	1,30	1,51
537419601 (5)	Botón P25	1,50	1,74
531025901 (6)	Carrete hilo P25	6,95	8,06
537419701 (7)	Ovalillo P25	1,23	1,43
537419401 (8)	Carcasa inferior P25	4,93	5,72

TRIMMY P35

531025002 (1)	P35 Trimmy presión completo	11,90	13,80
537421501 (2)	Carcasa superior P35	6,53	7,57
537427901 (3)	Adaptador P35	5,81	6,74
537186001 (4)	Muelle P35	1,30	1,51
537421801 (5)	Botón P35	1,45	1,68
531025902 (6)	Carrete hilo P35	6,95	8,06
537419701 (7)	Ovalillo P35	1,23	1,43
537421601 (8)	Carcasa inferior	5,37	6,23

DISCOS 2 PUNTAS

Modelo	Referencia	Diámetro exterior	Agujero interior	Grosor	P.V.P. Euros	P.V.P. €+IVA
	AI600510	255 mm	25,4 mm	1,4 mm	3,95	4,58







DISCOS 3 PUNTAS MODELOS PARTNER

Modelos	Referencia	Diámetro exterior	Agujero interior	Grosor	P.V.P. Euros	P.V.P. €+IVA
	(1) 537 14 89 02	255 mm	20 mm	3,45 mm	17,51	20,31
	B405 - B450 (2) 537 14 93 04	300 mm	20 mm	3,45 mm	19,56	22,69
	(3) 531 02 49 01	255 mm	25,4 mm	1,4 mm	12,23	14,19
	(3) AI600520	230 mm	25,4 mm	1,4 mm	6,00	6,96
	(5) AI405802	300 mm	20 mm	3 mm	7,95	9,22

DISCOS 3 PUNTAS MODELOS CAMON

	AI600600	255 mm	25,4 mm	3 mm	7,25	8,41
	AI600610	300 mm	25,4 mm	3 mm	7,95	9,22

DISCOS 4 PUNTAS MODELOS PARTNER

Modelos	Referencia	Diámetro exterior	Agujero interior	Grosor	P.V.P. Euros	P.V.P. €+IVA
	(1) 537 14 91 01	275 mm	20 mm	1,4 mm	13,90	16,12
	(2) 537 14 95 02	255 mm	20 mm	1,4 mm	12,63	14,65
	B265-B305 B323-B325 (3) 952 71 55 65	200 mm	20 mm	1,4 mm	19,54	22,66
	B245-B246-B322 (3) 952 71 55 66	200 mm	25,4 mm	1,4 mm	20,90	24,24
	B251-B260-B261 (4) 538 24 83 00	230 mm	25,4 mm	1,4 mm	10,96	12,71
	B310-B341-B400-B470 B4700-B522M-B422X-B472X (4) 538 24 83 01	255 mm	25,4 mm	1,4 mm	12,14	14,09

DISCOS 8 PUNTAS MODELOS PARTNER



Referencia	Diámetro exterior	Agujero interior	Grosor	P.V.P. Euros	P.V.P. €+IVA
531 02 49 06	230 mm	25,4 mm	1,4 mm	12,23	14,19

DISCOS 8 PUNTAS MODELOS CAMON



AI600040	255 mm	25,4 mm	1,4 mm	7,25	8,14
----------	--------	---------	--------	------	------

DISCOS DE SIERRA



Referencia	Diámetro exterior	Agujero interior	Dientes Grosor	P.V.P. Euros	P.V.P. €+IVA
508 90 24 02	255 mm	20 mm	22 T	12,85	14,90
508 90 14 02	200 mm	20 mm	18 T	11,55	13,40
508 90 45 03	-	25,4 mm	26 T	11,53	13,37
508 90 15 02	200 mm	20 mm	26 T	9,88	11,46
538 04 09 98	230 mm	20 mm	24 T	16,90	19,60



DISCOS DE SIERRA MODELOS CAMON



AI600060	255 mm	25,4 mm	70 T	9,95	11,54
----------	--------	---------	------	------	-------

PROTECTORES MODELOS PARTNER

		Modelos	Referencia	Tipo	P.V.P. Euros	P.V.P. €+IVA
1	2	T221<1994	(1) 530 06 92 99	Trimmy	26,00	30,16
						
		T221>1995 -T240 T321>1995	(2) 530 06 96 66	Trimmy	23,39	27,13
3	4	T220-T225-T260 T320-T321<1994	(3) 530 06 92 49	Trimmy	19,60	22,74
						
		Colibri 25	(4) 530 07 16 83	Trimmy	12,50	14,50
5	6	Colibri Plus	(5) 530 06 97 52	Trimmy	24,27	28,15
						
		T285-B265 B305-B323 B322-B325	(6) 530 06 92 56	Trimmy	18,59	21,56
7	8	B245-B246	(7) 530 01 42 10	Disco 4 T (200 mm)	29,70	34,45
						
		B260-B261 B310-B341	(8) 538 22 99 56	Disco 8 T (200 mm) y Trimmy	5,87	6,81
9	10	B260-B261 B310-B341	(9) 538 24 91 55	Disco 4 T (225 mm) y Trimmy	24,05	27,89
						
		B400-B420 B470-B4700 B422X-B472X B522M	(10) 538 24 05 53	Disco 22 T (225 mm)	6,31	7,32
11	12	B400-B420-B470-B4700 B422X-B472X-B522M	(18) 538 24 89 60	Disco 22 T (225 mm) y Trimmy	18,30	21,23
						
		B400-B420-B470-B4700 B422X-B472X-B522M	(10) 538 24 05 53	Disco Sierra 230 mm	6,31	7,32
13	14	B380 B405 B440 B450	(12) 503 91 60 02	Trimmy	11,79	13,68
						
		B380 B405 B440 B450	(13) 502 03 65 01	Disco y Trimmy	24,07	27,92
15	16					
		B380 B405 B440 B450	(14) 502 26 34 02	Disco 3 T (300 mm)	14,06	16,31
		B380 B405 B440 B450	(15) 502 27 22 01	Disco 18 T y 26 T (200 mm)	9,37	10,87
17	18					
		B380 B405 B440 B450	(16) 502 03 94 05	Disco 22 T (225 mm)	13,75	15,95
		B380 B405 B440 B450	(17) 502 03 95 04	Disco 4 T (255 mm)	10,96	12,71
17	18					

PROTECTORES MODELOS CAMON

	R29-R41-R54 F41-F54	AI722690	Disco 3 T (300 mm) y Trimmy	13,90	16,12
---	------------------------	----------	-----------------------------	-------	-------

<1994= anteriores al año 1994 / >1995= posteriores al año 1995

HILO DE CORTE REDONDO PARTNER



Referencia	Longitud	Grosor ø	P.V.P. Euros	P.V.P. €+IVA
531 02 40 01	15 m	1,3 mm	2,31	2,68
531 02 40 02	15 m	1,5 mm	2,31	2,68
531 02 40 04	15 m	2,0 mm	2,31	2,68
531 02 40 05	15 m	2,4 mm	3,08	3,57
531 02 40 06	10 m	3,0 mm	3,08	3,57
531 02 40 07	130 m	2,0 mm	10,03	11,64
531 02 40 08	90 m	2,4 mm	10,03	11,64
531 02 40 09	56 m	3,0 mm	10,03	11,64
531 00 92 39	75 m	3,3 mm	15,80	18,32
531 00 60 52	240 m	2,4 mm	24,07	27,92
531 00 60 54	240 m	3,0 mm	37,29	43,26

HILO DE CORTE TRENZADO PARTNER



Referencia	Longitud	Grosor ø	P.V.P. Euros	P.V.P. €+IVA
531 02 40 10	15 m	1,3 mm	2,31	2,68
531 02 40 11	15 m	1,5 mm	2,40	2,78
531 02 40 13	15 m	2,0 mm	2,66	3,09
531 02 40 14	15 m	2,4 mm	3,34	3,88
531 02 40 15	10 m	3,0 mm	3,34	3,88
531 02 40 16	130 m	2,0 mm	11,55	13,40
531 02 40 17	90 m	2,4 mm	11,55	13,40
531 02 40 18	56 m	3,0 mm	11,55	13,40
531 00 60 86	240 m	2,4 mm	31,61	36,67
531 00 60 88	240 m	3,0 mm	50,67	58,70

CAJA EXPOSITOR

Caja expositor 60 bobinas hilo redondo

Cada caja contiene:

- 20 bobinas 15 m ø 1,5 mm
- 20 bobinas 15 m ø 2 mm
- 20 bobinas 15 m ø 2,4 mm

Referencia	P.V.P. Euros	P.V.P. €+IVA
531 02 07 39	146,45	169,89



Caja expositor 60 bobinas hilo trenzado

Cada caja contiene:

- 20 bobinas 15 m ø 1,5 mm
- 20 bobinas 15 m ø 2 mm
- 20 bobinas 15 m ø 2,4 mm

Referencia	P.V.P. Euros	P.V.P. €+IVA
531 02 07 40	148,43	172,64

HILO DE CORTE REDONDO E.M.



Referencia	Longitud	Grosor	Color	P.V.P. Euros	P.V.P. €+IVA
591 00 59 16	15 mts	1,6 mm	Azul	2,10	2,44
591 00 59 17	15 mts	2,0 mm	Verde	2,35	2,73
591 00 59 18	15 mts	2,4 mm	Naranja	2,75	3,19
591 00 59 21	15 mts	3,0 mm	Rojo	3,25	3,77
591 00 59 26	41 mts	3,5 mm	Blanco	10,25	11,89

ARNÉS SIMPLE MODELOS PARTNER



Modelos	Referencia	P.V.P. Euros	P.V.P. €+IVA
B245 B246	538 24 12 20	3,90	4,52

ARNÉS SIMPLE MODELOS CAMON



	AI751580	4,90	5,68
	AI751620	5,95	6,90

ARNÉS DOBLE

Arnés doble para desbrozadores grandes

Correas de hombros ajustables con acolchado grueso.

Cierre rápido en la placa del pecho.



1

2



3

4







5





6

Modelos Partner	Referencia	P.V.P. Euros	P.V.P. €+IVA
B322 B323 B325	(1) 537 21 63 01	23,54	27,31
B260 B261 B310 B341	(2) 538 24 09 02	11,90	13,80
B380 B405 B440 B450G	(3) 502 12 36 04	29,95	34,74
B422X-B472X-B522M B400-B420-B470-B4700	(4) 538 24 25 20	35,73	41,44
Modelos Camon	Referencia	P.V.P. Euros	P.V.P. €+IVA
R29 - C34M R41 - P410M R54 - P540M	(5) AIC19994	20,95	24,30
EK28 - C26M	(6) AI752820	5,90	6,84

DESBROZADORAS DE RUEDAS

Modelo	Referencia	Ancho de trabajo	Motor	Velocidad	Carcasa	P.V.P. Euros	P.V.P. €+IVA
	E51FIRST	51 cm Alturas de corte regulables	B&S QUANTUM XTE 5,5 HP	1	Acero	860,34	998,00
	P51 X-TREM H	51 cm Alturas de corte regulables	Honda GCV190 6,5 HP	Variador	Acero	1.029,31	1.194,00
	JUNIOR	52 cm	B&S Intek 6 cv	2+1	Acero	1.525,00	1.769,00
	SENIOR	65 cm	Honda GXV 340 OHV	3+1	Acero	2.618,10	3.037,00
	KIT	Ruedas delanteras opcionales				275,86	320,00





ACCESORIOS DESBROZADORAS DE RUEDAS

Modelo	Referencia	Descripción	Junior	P51 Antigua	P51 Moderna	P51H Antigua	P51H Moderna	PL10 PL20	PL45	P.V.P. Euros	P.V.P. €+IVA
	PU13571	Correa tracción	X							9,90	11,48
	PU13572	Correa cuchillas	X							19,50	22,66
	PU13466	Correa		X	X	X				4,25	4,93
	PU13457	Correa					X			4,95	5,74
	PU13559B	Correa cuchillas						X	X	22,10	25,64
	PU13481A	Correa tracción						X	X	12,25	14,21
	PU13086B	Cable regulador alturas		X		X				15,75	18,27
	PU13831	Cable regulador alturas			X					7,90	9,16
	PU13151A	Cable regulador alturas					X			7,90	9,16
	PU13090A	Cable freno-motor		X		X				6,90	8,00
	PU13805	Cable freno-motor	X							26,90	31,20
	PU13813	Cable freno-motor			X					6,95	8,06
	PU13194B	Cable freno-motor					X			5,25	6,09
	PU13129A	Cable gas	X							3,75	4,35
	PU62764B	Cable gas		X		X				3,75	4,35
	PU13839	Cable gas			X					3,75	4,35
	PU13251B	Cable gas					X			3,75	4,35
	PU13141	Cable gas						X	X	3,75	4,35
	PU13804	Cable embrague avance	X							12,25	14,21
	PU13811A	Cable embrague avance			X					11,95	13,86
	PU13185A	Cable embrague avance		X		X				11,95	13,86
	PU13085A	Cable embrague avance			X					10,25	11,89
	PU13817	Cable embrague cuchilla	X							13,20	15,31
	PU13800	Cable embrague avance					X			8,25	9,57
	PU13097	Cable embrague avance						X	X	15,50	17,98
	PU13814	Cable marchas 2 vel.					X			10,90	12,64
	PU13110	Cable marchas 3+1 vel.						X	X	8,95	10,38
	PU13989	Cuchilla 51 cm desbroce		X	X	X	X			13,50	15,66
	PU13994	Cuchilla 53 cm corte						X		15,90	18,44
	PU13996	Cuchilla 53 cm desbroce						X		24,95	28,94
	PU13993	Cuchilla 63 cm corte							X	17,90	20,76
	PU13995	Cuchilla 63 cm desbroce							X	26,40	30,62
	PU13988	Cuchilla triscada 51 cm	X	X	X	X	X			19,90	23,08

MOTOAZADAS

Modelo	Referencia	Velocidad adelante	Velocidad atrás	Motor	P.V.P. Euros	P.V.P. €+IVA
	FT3540 B 9538781 -11	1	-	Motor: B&S 3,5 HP OHV Ancho trabajo: 40/4 fresas Profundidad: 26 cm Peso: 30 kg Mecánica con manecillas	383,62	445,00
	P5110 GX	1	-	Motor: Honda GX 160 Ancho de trabajo: 60/90 cm Profundidad: 32 cm Peso: 50 kg Mecánica con manecillas	521,55	605,00
	P5112 GX	1	1	Motor: Honda GX 160 Ancho de trabajo: 60/90 cm Profundidad: 32 cm Peso: 50 kg Mecánica con manecillas	582,76	676,00
	P105 BOHV P115 BOHV	1	-	Motor: B&S 5,5 HP OHV Ancho de trabajo: 60/90 cm Profundidad: 32 cm Peso: 50 kg Mando neumático	576,72	669,00
		1	1		636,21	738,00
	P105 H P115 H	1	-	Motor: Honda GC 160 Ancho de trabajo: 60/90 cm Profundidad: 32 cm Peso: 50 kg Mando neumático	607,76	705,00
		1	1		664,66	771,00

MOTOAZADAS

Modelo	Referencia	Velocidad adelante	Velocidad atrás	Motor	P.V.P. Euros	P.V.P. €+IVA
	PRT 5043 RB 9647999-00	1	1	Motor: B&S Inteck 5,5 HP Ancho de trabajo: 43 cm Profundidad: 30 cm Peso: 90 kg Rotación: 190 r.p.m.	853,45	990,00
	C 550 GX	2	1	Motor: HONDA GX160 Ancho de trabajo: 60/90 cm Profundidad: 32 cm Peso: 50 kg	978,45	1.135,00
	QUATRO SENIOR P513GX	3	1	Motor: HONDA GX200 Ancho de trabajo: 60/90 cm Profundidad: 32 cm Peso: 82 kg	1.437,93	1.668,00
	MICRO	1	-	Honda GX-31	453,45	526,00
		Ancho de fresa 24 cm. Peso: 18 Kg				
	PU19002300	Kit opcional: escarificador y aporcador			148,28	172,00

ACCESORIOS MOTOAZADAS



Descripción	Referencia	Modelos	P.V.P. Euros	P.V.P. €+IVA	
Cuchilla recta DX	PU81906	C-550-5110-5112-P105-P115	2,20	2,55	
Cuchilla recta SX	PU81907	C-550-5110-5112-P105-P115	2,20	2,55	
Cuchilla helicoidal DX	PU81911	C-550-6210-6210HD	2,20	2,55	
Cuchilla helicoidal SX	PU81912	C-550-6210-6210HD	2,20	2,55	
Fresa simple int. DX ø 25 mm	PU55097	C-550-5110-5112-P105-P115	17,50	21,46	
Fresa simple int. SX ø 25 mm	PU55098	C-550-5110-5112-P105-P115	17,50	21,46	
Fresa simple ext. SX ø 25 mm	PU55150	C-550-5110-5112-P105-P115	16,90	19,60	
Fresa simple ext. SX ø 25 mm	PU55124A	6210-6210H	23,90	27,72	
Fresa simple ext. SX ø 30 mm	PU55049	6210HD-P513	34,65	40,19	
Fresa simple ext. DX ø 25 mm	PU55103	C-550-5110-5112-P105-P115	16,90	19,60	
Fresa simple ext. DX ø 25 mm	PU55123A	6210-6210H	23,90	27,72	
Fresa simple ext. DX ø 30 mm	PU55048	6210HD-P513	34,65	40,19	
Fresa doble DX ø 25 mm	PU55200	C-550-5110-5112-P105-P115	32,90	38,16	
Fresa doble DX ø 25 mm	PU55121	6210-6210H	32,90	38,16	
Fresa doble DX ø 30 mm	PU55046	6210HD-P513	48,40	51,30	
Fresa doble SX ø 25 mm	PU55201	C550-5110-5112-P105-P115	32,90	38,16	
Fresa doble SX ø 25 mm	PU55122A	6210-6210H	32,90	38,16	
Fresa doble SX ø 30 mm	PU55047	6210HD-P513	48,40	51,30	
Protector plantas ø 25 mm	PU55102	C550-5110-5112-P105-P115	8,40	9,74	
Protector plantas ø 30 mm	PU55035	6210HD-P513	9,70	11,25	
Kit fresas+protectores de plantas ø 25 mm	SLJF3A	C550-5110-5112 P105-P115	94,60	109,74	
Descripción	Referencia	Modelos	Eje	P.V.P. Euros	P.V.P. €+IVA
Par ruedas transporte ø 25 mm	SLRTL P	C550-P105 P115-5110-5112	ø 25 mm	65,90	76,44
Par ruedas transporte ø 30 mm	SLRTLQ	6210HD-P513	ø 30 mm	65,90	76,44

DX= derecha.
SX= izquierda.

ACCESORIOS MOTOAZADAS



Descripción	Referencia	P.V.P. Euros	P.V.P. €+IVA
Remolque 400 kg. Basculante con freno	531 02 07 12	790,00	916,40



Descripción	Referencia	Modelo	P.V.P. Euros	P.V.P. €+IVA
Contrapeso delantero 20 kg	SL20K/P	P-105-P115 5110 - 5112	73,00	84,68
	SL20K/F	C550GX P513GX	73,00	84,68



Descripción	Ref.	Modelo	P.V.P. Euros	P.V.P. €+IVA
Teas arado vertedera reversible	Teas 5	5110-5112 P105/P115	28,95	33,58
	Teas 6	C550-P513GX	28,95	33,58



Descripción	Ref.	P.V.P. Euros	P.V.P. €+IVA
Arado vertedera reversible	SLCCE-3	139,90	162,28



Descripción	Referencia	Modelo	P.V.P. Euros	P.V.P. €+IVA
Teas aporcador	Teas1	P105-P115-5110-5112	19,50	22,62
Arado aporcador	997 00 16 10	P105-P115-5110-5112	26,95	31,26

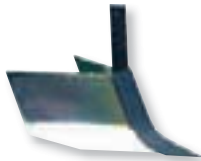

Arado aporcador



Referencia	P.V.P. Euros	P.V.P. €+IVA
SLAS-07/08	41,90	48,60

Arrancador patatas



Referencia	P.V.P. Euros	P.V.P. €+IVA
SLAP	47,50	55,10



Descripción	Referencia	Modelo	P.V.P. Euros	P.V.P. €+IVA
Teas aporcador y arrancador de patatas	Teas 2	P105-P115-5110-5112	20,90	24,24
	Teas 3	C550-P513GX	20,90	24,24
	Teas 4	C215	20,90	24,24

ACCESORIOS MOTOAZADAS



Descripción	Referencia	Modelo	P.V.P. Euros	P.V.P. €+IVA
Teas arado japonés y cultivador	Teas 8	P105-P115-5110-5112	16,90	19,60
	Teas 9	C550GX-P513GX	16,90	19,60
	Teas 10	C215	16,90	19,60

Arado japonés



Referencia	P.V.P. Euros	P.V.P. €+IVA
SLAJD	205,90	238,84

Cultivador 3 brazos



Referencia	P.V.P. Euros	P.V.P. €+IVA
SLC-3BT	108,25	125,57



Descripción	Referencia	Medidas	P.V.P. Euros	P.V.P. €+IVA
Par de ruedas neumáticas	SL 400x8	400x8	85,00	98,60
	SL500x10	500x10	165,00	191,40



Descripción	Referencia	Medida rueda	P.V.P. Euros	P.V.P. €+IVA
Par de contrapesos 40 kg. para ruedas neumáticas y metálicas	SL 40K-8	350 y 400 mm	103,00	119,48
	SL40K-10	500 mm	103,00	119,48



Descripción	Referencia	Diámetro	P.V.P. Euros	P.V.P. €+IVA
Par de ruedas metálicas	SLR-2,4	320 mm	95,00	110,20



Descripción	Referencia	Agujero	P.V.P. Euros	P.V.P. €+IVA
Par casquillos con platina	SLCP25	25 mm	23,90	27,72
	SLCP30	30 mm	23,90	27,72



Descripción	Referencia	Modelos	P.V.P. Euros	P.V.P. €+IVA
Par ejes ø 25 mm	SLEJD25	C550-5110-5112-P105-P115	67,50	78,30
Par ejes ø 30 mm	SLEJD30	6210HD-P513GX	67,50	78,30

CASCO PROTECTOR SEMIPROFESIONAL



Referencia	P.V.P. Euros	P.V.P. €+IVA
505 68 57 01	34,25	39,73

Un casco algo más simple pero eficaz, con interior de plástico en 6 puntos. Ajustable en altura. Provisto de visor y protectores acústicos. Probado y aprobado según EN 397, 352-3 y 1731.

REPUESTO CASCO PROTECTOR

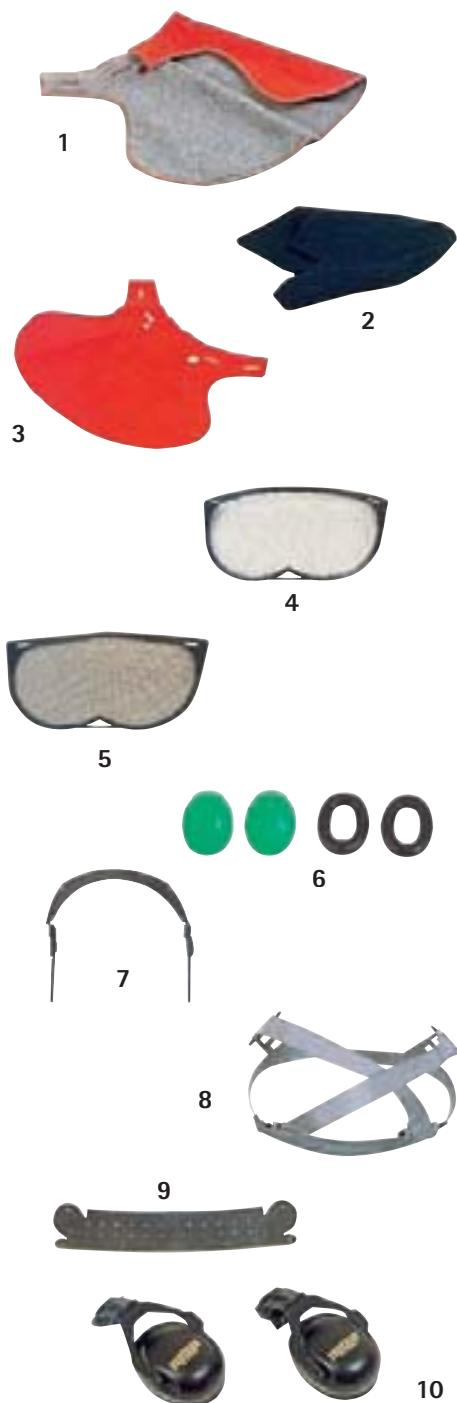

Referencia	Denominación	P.V.P. Euros	P.V.P. €+IVA
504 98 17 04 ⁽¹⁾	1.- Protector cuello con forro	9,50	11,02
505 66 51 15 ⁽²⁾	2.- Gorro acrílico (talla única)	4,75	5,51
505 66 53 06 ⁽³⁾	3.- Protector cuello	3,15	3,65
505 66 53 19 ⁽⁴⁾	4.- Visor malla nylon	9,77	11,33
505 66 53 21 ⁽⁵⁾	5.- Visor malla metálico	8,18	9,49
505 66 53 26 ⁽⁶⁾	6.- Conjunto "higiénico"	9,24	10,72
505 66 53 28 ⁽⁷⁾	7.- Soporte visor CPL	9,50	11,02
505 66 53 30 ⁽⁸⁾	8.- Arnés casco	9,77	11,33
505 67 53 18 ⁽⁹⁾	9.- Banda sudadera	3,15	3,65
505 68 57 06 ⁽¹⁰⁾	10.- Conjunto auriculares	21,19	24,58

AURICULARES CON VISOR PARTNER



Referencia	Denominación	P.V.P. Euros	P.V.P. €+IVA
505 68 53 41	1.- Auriculares con visor plexiglás Homologación EN 352-3 y EN 166	31,90	37,00
505 68 53 50	2.- Auriculares con visor malla Homologación EN 352-1 y EN 1731	30,95	35,91

REPUESTOS AURICULARES CON VISOR PARTNER



Referencia	Denominación	P.V.P. Euros	P.V.P. €+IVA
505 66 53 19	1.- Visor malla nylon	9,77	11,33
505 66 53 41	2.- Juego cintas ajuste	1,89	2,19
505 66 53 42	3.- Juego soportes visor	2,73	3,16
505 66 53 43	4.- Visor plexiglás	9,24	10,72
505 66 53 63	4.- Visor plexiglás anti-vaho	19,00	22,04

AURICULAR CON VISOR

EN-352-1



Referencia	P.V.P. Euros	P.V.P. €+IVA
(1) 531 02 47 04	17,01	19,73
(2) 531 02 47 02	24,73	28,68

CAJA EXPOSITOR 10 UD. DE AURICULARES PARA JARDÍN



Referencia	P.V.P. Euros	P.V.P. €+IVA
505 68 90 15	85,90	99,64

Protectores fabricados en ABS resistente a los impactos. Probados y aprobados según EN 352-1.

AURICULARES PARTNER

Auriculares con radio FM



Referencia	P.V.P. Euros	P.V.P. €+IVA
505 68 56 10	85,49	99,17

Nuevo circuito de radio mejorado de sintonización y ajuste automáticos. Puede programarse en posición mono en caso de mala recepción. Desconexión automática. Fleje probado y aprobado según PrEN 352-1. Acoples para el casco probados y aprobados según PrEN 352-3.

AURICULARES CON FLEJE



Referencia	P.V.P. Euros	P.V.P. €+IVA
531 02 47 11	15,44	17,92

Un nuevo diseño permite ajustar la presión un 20%. EN 352-1 Ligeros, con fleje.

ALMOHADILLAS PARA EL SUDOR



Aros desechables de material muy absorbente, fáciles de colocar en los auriculares. Válidos para todos los protectores Partner.

Referencia	P.V.P. Euros	P.V.P. €+IVA
505 66 53 31	2,88	3,34

AURICULARES Y VISORES PARTNER-CAMON

Modelo	Referencia	Denominación	P.V.P. Euros	P.V.P. €+IVA
	AI120951	Auriculares con protección de frecuencia 1000 a 8000 Hz CE Peso: 165 g	15,25	17,69
	AI121001	Auriculares Alta protección Peso: 140 g	4,90	5,68
	AI21023	Gafas protectoras con orificios ventilación	4,65	5,39
	505 67 53 32	Gafas de protección Partner. Adecuadas para utilizar con visor durante el corte. Lentes resistentes a rayos UV y a arañazos. Pueden ajustarse en 3 ángulos. Monturas laterales de longitud ajustable. Homologación CE acorde con la norma EN 166	8,98	10,41
	AI751230	Visor de malla pequeña	4,90	5,68
	AI751180	Visera con policarbonato Espesor 1 mm Con fieltro anti-sudor	4,95	5,74
	AI751860	Visera con malla metálica con fieltro anti-sudor uso profesional CE	6,95	8,06

CHAQUETA FORESTAL



Referencia	Talla
531 02 43 46	46/48
531 02 43 50	50/52
531 02 43 54	54/56
531 02 43 58	58/60
P.V.P. Euros	P.V.P. €+IVA
65,67	76,18

Fabricada en poliéster 80% y algodón 20% con forro de malla para una buena ventilación.

CHAQUETA ANTICORTE



Referencia	Talla
505 61 99 46	46/48 (S)
505 61 99 50	50/52 (M)
505 61 99 54	54/56 (L)
505 61 99 58	58/60 (XL)
P.V.P. Euros	P.V.P. €+IVA
119,00	138,04

Homologación:
EN 381-11 CLASS: 1

Chaqueta en color naranja fluorescente con protección contra sierra en cuello, pecho, brazos y hombros. Exterior 100% poliéster "ultra".

PANTALONES ANTICORTE



Referencia	Talla
531 02 45 46	46
531 02 45 48	48
531 02 45 50	50
531 02 45 52	52
531 02 45 54	54
531 02 45 56	56
531 02 45 58	58
531 02 45 60	60
P.V.P. Euros	P.V.P. €+IVA
99,66	115,61

Homologación:
EN 381-5 y EN 340 / DESIGN: A CLASS: 1
Con peto y 9 capas de protección frontal en las piernas y solapa de 5 cm sobre la costura exterior de la pierna izquierda y la costura interior de la pierna derecha.



Referencia	Talla
531 02 44 46	46
531 02 44 48	48
531 02 44 50	50
531 02 44 52	52
531 02 44 54	54
531 02 44 56	56
531 02 44 58	58
531 02 44 60	60
P.V.P. Euros	P.V.P. €+IVA
91,94	106,65

Homologación:
EN 381-5 / DESIGN: A CLASS: 1

Con 9 capas de protección frontal en las piernas y solapa de 5 cm sobre la costura exterior de la pierna izquierda y la costura interior de la pierna derecha.

PANTALONES ANTICORTE



Referencia	Talla
505 69 75 09	Única
P.V.P. Euros	P.V.P. €+IVA
83,00	96,28

Homologación:
EN 381-5 y EN 340 / DESIGN: A CLASS: 1
Talla única. Sin culera y con cremalleras en las piernas para una colocación fácil por encima de la ropa.

EQUIPO DE SEGURIDAD



Referencia	
531 02 47 07	
P.V.P. Euros	P.V.P. €+IVA
128,00	148,48

Homologación:
EN 381, EN 340, EN397,
EN 352-3 y EN 1731.

Contiene:

- Pantalón anticorte 505 63 26 09.
- Casco protector 505 68 57 15.
- Par guantes 5 dedos 505 68 20 10.

BOTAS ANTICORTE LIGERAS



Referencia	Talla
531 02 46 40	40
531 02 46 41	41
531 02 46 42	42
531 02 46 43	43
531 02 46 44	44
531 02 46 45	45
531 02 46 46	46
531 02 46 47	47
P.V.P. Euros	P.V.P. €+IVA
66,90	77,60

Botas de bajo peso con punteras de acero. Suela antideslizamiento, apta para clavos. Con tobilleras. Perfil de tacón especial para quitárselas con facilidad. Con una horma adaptable para cómodo ajuste. Muy resistentes. Homologación CE acorde con la norma EN 345-2, Clase 2.

BOTAS ANTICORTE DE CUERO



Referencia	Talla
505 65 31 39	39
505 65 31 40	40
505 65 31 41	41
505 65 31 42	42
505 65 31 43	43
505 65 31 44	44
505 65 31 45	45
505 65 31 46	46
505 65 31 47	47
P.V.P. Euros	P.V.P. €+IVA
221,30	256,71

Homologación EN 345-2, clase 1, con punteras de acero

CALCETINES Y PLANTILLAS



Referencia	Talla	P.V.P. Euros	P.V.P. €+IVA
505 61 52 42	1.- Calcetines Partner T42	6,29	7,30
505 61 52 45	1.- Calcetines Partner T45	6,29	7,30
505 61 62 40	2.- Calcetines Partner T40	12,90	14,96
505 61 62 43	2.- Calcetines Partner T45	12,90	14,96
505 65 43 61	3.- Tacos (35 uds. c/colocador)	11,53	13,37
505 65 45 00	4.- Plantillas térmicas	5,17	6,00
505 65 46 38	5.- Calcetines de pelo T38	26,22	30,42
505 65 46 40	5.- Calcetines de pelo T40	26,22	30,42

BOTAS PARA OCIO



Referencia	Talla	P.V.P. Euros	P.V.P. €+IVA
505 65 47 39	39	62,88	72,94
505 65 47 40	40		
505 65 47 41	41		
505 65 47 42	42		
505 65 47 43	43		
505 65 47 44	44		

GUANTES PARTNER

	Referencia	Características	Talla	P.V.P. Euros	P.V.P. €+IVA
	531 02 47 08	Palmas de resistente cuero y dorso de poliéster para mayor comodidad. Cierre de velcro.	10	7,72	8,96
	531 02 47 09	Guantes anticorte Probados y aprobados según PrEN 381-4, -7, EN 420:1, EN 388 clase 0.	10	16,95	19,66
	505 64 17 10 505 64 17 12	Blandos y flexibles. Con tratamiento impermeable. Estos guantes son muy adecuados para los operarios de cortadoras mecánicas. Se ajustan con broches de velcro.	10 12	17,69	20,52

ROPA DE SEGURIDAD

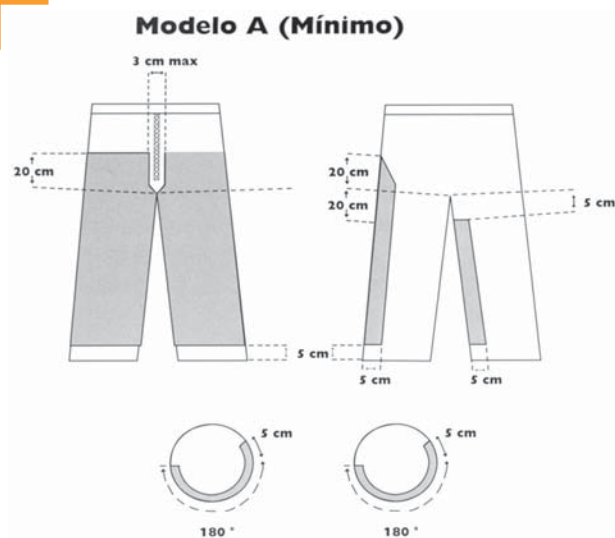

NORMAS UE PARA PANTALONES DE SEGURIDAD EN 381-5 y EN 340.

Los pantalones, broches, etc. deben soportar:

- 5 lavados a 60°C.
- No debe encoger más de un 6% a lo largo y ancho.
- Prueba de resistencia de costuras 20 N (fuerza de tensión).
- Prueba contra motosierra:
 - Clase 1, 20 m/s (requerimiento mínimo)
 - Clase 2, 24 m/s (requerimiento mínimo)
 - Clase 3, 28 m/s (requerimiento mínimo)
- Protección de la pierna:
 - Modelo A / Modelo B / Modelo C



BIDÓN COMBI Y BIDÓN 6 L



Referencia	Denominación	P.V.P. Euros	P.V.P. €+IVA
531 02 48 12	1.- Depósito Combi 6 + 2,5 L.	21,95	25,46
531 02 48 13	2.- Depósito 6 L	16,95	19,66

Con capacidad para 6 litros de combustible y 2,5 litros de aceite de cadena. Incluye eficaz protección contra reboso. Cuando el depósito está lleno, se para automáticamente el llenado para evitar derrames. Los bidones se pueden separar. Entre ambos hay espacio para limas y herramientas.

Aprobado por el Instituto Sueco de Investigación y Pruebas.

Aprobado según la regulación UN.3H1 / Y / 200 / JR / S / SD - 93102

ACCESORIOS BIDÓN



Referencia	Denominación	P.V.P. Euros	P.V.P. €+IVA
505 68 80 09	1.- Depósito de aceite 2,5 L.	9,28	10,72
505 69 80 02	2.- Válvula gasolina	10,87	12,61
505 69 80 03	3.- Válvula aceite	5,52	6,41
505 69 80 11	4.- Tapón con soporte	3,94	4,57
505 69 80 22	5.- Embudo	3,67	4,26
505 69 80 24	6.- Llave porta discos	7,11	8,24

BIDÓN DE COMBUSTIBLE



Referencia	P.V.P. Euros	P.V.P. €+IVA
505 69 80 40	22,51	26,11

Adaptado especialmente para cortacéspedes y automóviles con catalizador. 6 litros de capacidad.

Aprobado por el Instituto Sueco de Investigación y Pruebas.

PORTA CUCHILLAS



Referencia	P.V.P. Euros	P.V.P. €+IVA
505 69 80 23	22,22	25,78

Permite fijar 3 ó 4 cuchillas en el bidón de gasolina. Incluye llave para el cambio de cuchilla-

TIRANTES PARTNER



Referencia	Tipo	P.V.P. Euros	P.V.P. €+IVA
505 68 85 00	Clips metálicos	15,00	17,40
505 68 85 10	Clips de cuero	19,00	22,04

CINTURONES PARTNER



505 69 00 01	Piel, cuero	14,87	17,25
505 69 00 00	PVC	7,22	8,37

TABLA DE TALLAS (CAMISAS Y PANTALONES)

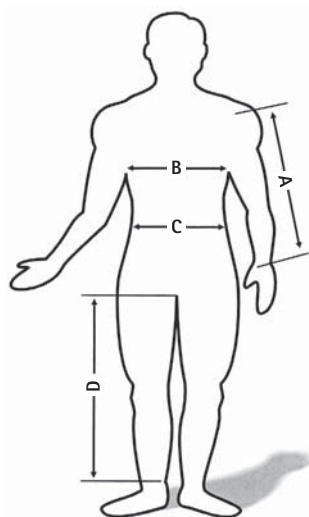

Talla Camisas	A	B	Talla Pantalones	C	D
46/48 - Pequeña (S)	72	124	44	87	76
			46/D92	91	76,5
50/52 - Mediana (M)	72	132	48/D96	95	77
			50/D100	99	78
54/56 - Grande (L)	74	140	52/D104	103	79
			54/D108	107	80
58/60 - X Grande (XL)	76	148	56/D112	111	80,5
			58/D116	115	81
62/64 - XX Grande (XXL)	77	152	60/D120	119	82

ACCESORIOS VARIOS



Referencia	Descripción	P.V.P. Euros	P.V.P. €+IVA
531 00 92 96	Cargador Mantenimiento de Baterías	49,00	56,84



4750454131	Funda Tractor	39,00	45,24
------------	---------------	-------	-------

HERRAMIENTAS DE TALLER

Llaves



Fig.	Referencia	Tipo	P.V.P. Euros	P.V.P. €+IVA
1	502 71 27 01	TX 25 ★	9,53	11,05
2	502 71 31 01	TX 30 ★	10,23	11,87
3	504 90 00 04	3 mm ●	4,53	5,26
4	504 90 00 02	4 mm	4,53	5,26
5	504 90 00 03	5 mm	4,75	5,51
6	504 90 00 01	6 mm	4,88	5,67
7	502 50 57 01	3/16" ●	4,99	5,79
8	502 51 67 01	TX 20 ★	5,72	6,64
9	502 50 86 01	4 mm ●	5,72	6,64
10	502 50 87 01	5 mm	5,72	6,64
11	502 50 88 01	6 mm ●	6,07	7,04
12	505 38 13 08	8mm ○	12,25	14,21
13	505 38 13 07	M5	9,77	11,33
14	504 90 00 06	Kit llaves	25,00	29,00
15	530 03 55 60	Llave Reg. Carb.	7,75	8,99

ÚTILES TALLER



Fig.	Referencia	Denominación	P.V.P. Euros	P.V.P. €+IVA
1	502 50 33 01	Trabador de pistón	3,39	3,93
2	502 51 61 01	Útil carter-cigüeñal	48,58	56,35
3	502 50 70 01	Útil aros del pistón	5,72	6,64
4	502 52 17 01	Útil codo engranajes	15,71	18,22
5	504 90 90 01	Extractor rodamientos	65,25	75,69
6	502 71 13 01	Bujía de pruebas	8,58	9,95
7	502 51 02 01	Soporte motosierras	309,56	359,09
8	502 51 03 01	Soporte desbrozadoras	95,02	110,22

CINTURÓN PORTA HERRAMIENTAS



Referencia	Denominación	P.V.P. Euros	P.V.P. €+IVA
505 69 32 16	1.- Cinturón porta-herramientas	19,80	22,97
531 02 56 18	2.- Cartuchera gancho o tenaza	8,12	9,42
505 68 05 11	3.- Cartuchera posterior	16,68	19,34
505 69 32 17	4.- Kit 8 tornillos	6,45	7,48

HACHAS DE ACERO SUECO Y MANGOS DE NOGAL



505 69 45 00	3.- Hacha 68 cm	25,00	29,00
505 69 45 01	Mango repuesto 26"	10,58	12,28
505 69 45 05	2.- Hacha 82 cm Martillar	61,09	70,87
505 69 45 03	Mango repuesto 33"	16,59	19,24
505 69 45 06	1.- Hacha 74 cm Hendir	48,00	55,68
505 69 45 02	Mango repuesto 30"	15,25	17,69
505 69 45 07	4.- Hacha poda	19,56	22,69

KIT CINTURÓN PORTA-HERRAMIENTAS



Referencia	P.V.P. Euros	P.V.P. €+IVA
531 02 20 09	126,00	146,16

Cada caja contiene: 2 cartucheras delanteras, 1 cartuchera trasera, 1 gancho para troncos, 1 tenaza para troncos de 21 cm y 1 cinta métrica de 15 cm.

CUÑA PARA TALA

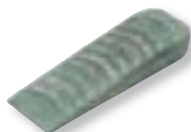

Referencia	P.V.P. Euros	P.V.P. €+IVA
505 69 47 00	4,36	5,05

TENAZAS PARA TRONCOS



Referencia	Long.	P.V.P. Euros	P.V.P. €+IVA
531 02 56 09	21 cm	15,44	17,92
505 69 31 01	30 cm	35,00	40,60

CUÑA PARA HENDIR 2 KG / 18 CM



505 69 47 01	24,90	28,89
--------------	-------	-------

CALIBRADORES



505 69 47 30	36 cm	20,06	23,27
505 69 47 46	46 cm	20,88	24,22

GANCHO PARA TRONCOS



531 02 56 10	12,98	15,06
--------------	-------	-------

PALANCA DERRIBO Y GANCHO



531 02 56 11	30,14	34,96
--------------	-------	-------

CINTA MÉTRICA



531 02 56 14	15 cm	37,86	43,92
505 68 73 20	20 cm	49,52	57,45

ACCESORIOS PODA E.M.

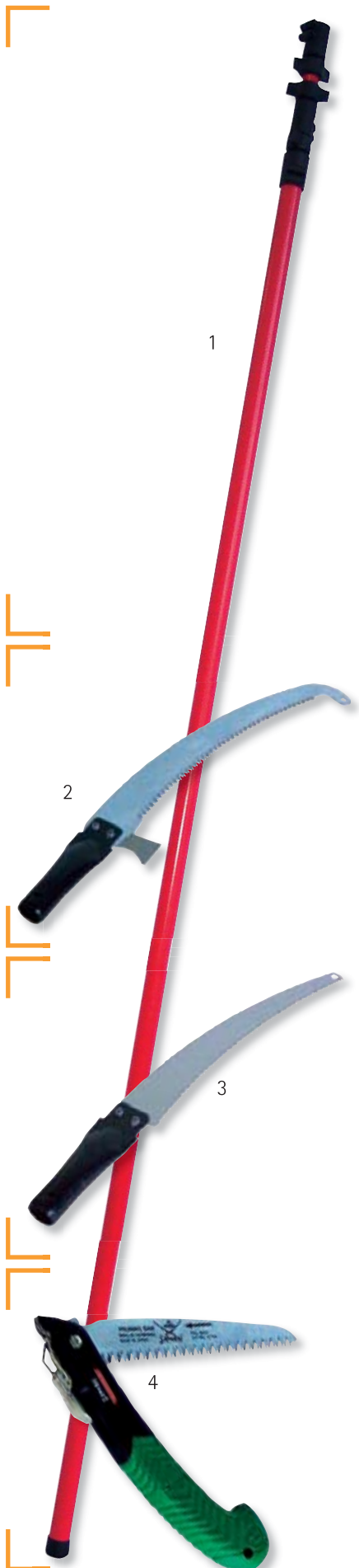

Referencia	Descripción	P.V.P. Euros	P.V.P. €+IVA
502 42 73 01	(1) Barra extensible. De 2,5 a 5 metros. Longitud ajustable de fácil manipulación.	65,00	75,40
505 69 45 66	(2) Sierra para ramas. Se acopla a la barra extensible. Hoja curvada con gancho en el extremo frontal y cuchilla de impacto para cortar sin desgajar.	53,00	61,48
505 69 45 77	(2) Cuchilla de repuesto	37,00	42,92
505 69 45 76	(3) Sierra para ramas. Modelo más sencillo sin cuchilla de impacto. Se acopla también a la barra extensible.	18,00	20,88
505 69 45 87	(3) Cuchilla de repuesto	12,00	13,92
505 69 45 68	(4) Navaja de poda (plegable)	33,00	38,28
505 69 45 79	(4) Cuchilla de repuesto	24,00	27,84

ACEITES Y GRASA PARTNER

	Referencia Denominación	P.V.P. Euros	P.V.P. €+IVA		Referencia Denominación	P.V.P. Euros	P.V.P. €+IVA
 Caja 25 uds.	531 02 48 07 Aceite 2T 0,1 L	1,69	1,96	 Caja 12 uds.	531 02 10 60 Aceite engrase cadena 1 L	3,95	4,58
 Caja 12 uds.	531 02 48 02 Aceite 2T 1 L	5,34	6,19	 Caja 4 uds.	531 02 10 61 Aceite engrase cadena 5 L	14,35	16,65
 Caja 30 uds.	502 51 48 01 Tubo grasa 225 g	5,75	6,67	 Caja 12 uds.	531 02 48 01 Aceite 4 T 0,6 L	3,36	3,90

PUBLICIDAD PARTNER

	Referencia	Descripción	P.V.P. Euros	P.V.P. €+IVA
	A0020	Visera negra bordada	7,90	9,16
	A0021	Visera amarilla o negra	2,90	3,36
	A0027	Naipes español	3,95	4,58
	A0029	Bolsa consumo	0,29	0,34
	A0035	Camiseta	3,95	4,58
	A0036	Paraguas	9,90	11,48
	A0007-XX	Buzo taller (XX=talla 50 a 62)	22,95	26,62
	A0005-XX	Bata taller (XX=talla 50 a 62)	19,25	22,33
	A0049-XX	Peto taller (XX=talla 50 a 62)	20,95	24,30



Flymo

CORTACÉSPEDES FLOTANTES SIN RUEDAS Y SIN RECOGEDOR

Modelo	Referencia Potencia	Ancho de corte Superficie rec.	Peso*	Alturas de corte	Capacidad Recogedor	P.V.P. Euros	P.V.P. €+IVA
	MICRO LITE 9632802-62 1.000 W	28 cm 200 m ²	4,5 Kg	Dos 10-33 mm	S/R	83,62	97,00
	TURBO LITE 350 9633513-62 1.400 W	35 cm 400 m ²	7,5 Kg	Cinco 15-41 mm	S/R	107,76	125,00
	VISION COMPACT 330 9633306-62	33 cm 300 m ²	10,5 Kg	Cuatro 12-32 mm	Interno 30 Litros	187,93	218,00

CORTACÉSPEDES FLOTANTES GASOLINA

	XL500 9638507-59 HONDA GC160 5,5 HP	50 cm 1500 m ²	15 Kg	Tres 10-30 mm	S/R	727,59	844,00
---	---	------------------------------	-------	------------------	-----	--------	--------

CORTACÉSPEDES CON RUEDAS Y RECOGEDOR INCORPORADO

Modelo	Referencia Potencia	Ancho de corte Superficie rec.	Peso*	Alturas de corte	Capacidad Recogedor	P.V.P. Euros	P.V.P. €+IVA
	ROLLER COMPACT 340 9643403-62 1.500 W	34 cm 500 m ²	13,5 Kg	Cinco 20-75 mm Centralizado	Recogedor Interno 28 Litros	187,07	217,00
	ROLLER COMPACT 400 9644404-62 1.600 W	40 cm 600 m ²	15,3 Kg	Seis 20-65 mm Centralizado	Recogedor Interno 38 Litros	271,55	315,00
	PAC A MOW 9643305-62 1.200 W Novedad Mayo 2007	33 cm 500 m ²	-	-	29 Litros	150,86	175,00

CORTACÉSPEDES ELÉCTRICO CON TRACCIÓN

	RE 4600 9538765-13 1600 W	46 cm 1000 m ²	27 Kg	Cinco 30-70 mm Centralizado	Recogedor 55 Litros	320,69	372,00
---	--	------------------------------	-------	-----------------------------------	------------------------	--------	--------

CORTABORDES Y MULTIFUNCIONES ELÉCTRICOS

Modelo	Referencia Potencia	Ancho de corte	Longitud y diámetro hilo	Mecanismo alimentación	Peso	Observaciones	P.V.P. Euros	P.V.P. €+IVA
	MINITRIM AUTO 9648578-62	23 cm.	2x5 m ø1,5 mm	Automático	1,6 Kg	***	25,86	30,00
	CONTOUR 9648589-62 300W	25 cm	2X5m	Automático	1,7 Kg	Cabeza pivotante 90° Rodillo para rebordear y perfilar	50,00	58,00
	CONTOUR POWER PLUS 700 9648595-62 700W	30 cm	2X5m	Automático	3,5 Kg	Cabeza pivotante 90° Barra extensible, rodillo para rebordear y perfilar	81,90	95,00

CORTABORDES Y MULTIFUNCIONES ELÉCTRICOS

Modelo	Referencia Potencia	Ancho de corte	Longitud y diámetro hilo	Mecanismo alimentación	Peso	Observaciones	P.V.P. Euros	P.V.P. €+IVA
	SAMURAI800 9648661-62 800W Novedad Mayo 2007	37 cm	10 m (2x5 m) 1,5 Ø	Semiaut.		Cabezal hilo 2 salidas	101,72	118,00
 CORDLESS 12v BATTERY	MULTI-TRIM CT 250X 964 8563-86 Batería 12 V	25 cm	10 m 1,5 Ø	Manual	4,2 Kg	Dos funciones Barra extensible Rodillo para reborderar y perfilar	95,00	110,00

MINICULTIVADOR

Modelo	Referencia Potencia	Accesorios	Peso	Observaciones	P.V.P. Euros	P.V.P. €+IVA
	MINICULTOR 9648120-86 270 W	Incluye punta multiusos, punta para remover, revolver. Mecanismo rápido para cambiar los accesorios	2,5 Kg	Velocidad variable 0-550 r.p.m.	45,69	53,00



Aspirador de jardín Garden Vac

El potente aspirador de jardín, con un sistema único que evita atascos, más fácil de usar. Tritura las hojas reduciéndolas para que sea más fácil hacer el compost. Un simple cambio en el interruptor para pasar de soplar a aspirar, no necesita tubos. Ambos productos están diseñados para triturar hojas reduciéndolas a una fracción de su tamaño original. Es capaz de recoger rápidamente ramas, papeles y hojas con una bolsa fácil de vaciar. El Garden Vac 2500 Plus viene con una rueda (que se puede poner y quitar) para un uso más cómodo.





ASPIRADORES DE EXTERIORES

Modelo	Referencia Potencia	Velocidad aire soplado	Caudal aire aspirado	Peso	Accesorios	P.V.P. Euros	P.V.P. €+IVA
	TORNADO 9527154-51 1600W	344 km/h	169 l/seg	3,2 Kg	Bolsa 35 litros y triturador 16:1	85,34	99,00
	GARDENVAC 2.500 9648637-62 2.500 W	212 km/h	250 l/seg	5,1 kg	Bolsa 40 litros y triturador	127,59	148,00

CORTASETOS ELÉCTRICOS

Modelo	Referencia	Largo barra	Separación cuchillas	Tiempo paro cuchilla	Peso	Observaciones	P.V.P. Euros	P.V.P. €+IVA
	HT5-50 9539003-35 500 W	50 cm Doble	22 Ø mm	0,02 seg.	3,2 Kg	Contacto seguridad ambas manos Incluye funda cuchilla Cuchilla doble acción	93,97	109,00

CORTASETOS ELÉCTRICOS

Modelo	Referencia	Largo barra	Separación cuchillas	Tiempo paro cuchilla	Peso	Observaciones	P.V.P. Euros	P.V.P. €+IVA
	HT5-60 9539003-36 500 W	60 cm Doble	27 Ø mm	0,02 seg.	3,6 Kg	Contacto seguridad ambas manos Incluye funda cuchilla Cuchilla doble acción	125,86	146,00
	HT6-70 9539003-38 600 W	70 cm Doble	27 Ø mm	0,02 seg.	3,7 Kg	Contacto seguridad ambas manos Incluye funda cuchilla Cuchilla doble acción	141,38	164,00
	EASICUT 510 9648182-62 500 W NOVEDAD JULIO 2007	51 cm	20 Ø mm	-	-	Contacto seguridad ambas manos Incluye funda cuchilla Cuchilla doble acción	81,03	94,00
	EASICUT 5500 9648184-62 550 W NOVEDAD JULIO 2007	50 cm	27 Ø mm	-	-	Contacto seguridad ambas manos Incluye funda cuchilla Cuchilla doble acción	102,59	119,00
	EASICUT 6500 XT 9648186-62 650 W NOVEDAD JULIO 2007	60 cm	34 Ø mm	-	-	Contacto seguridad ambas manos Incluye funda cuchilla Cuchilla doble acción	133,62	155,00

CUCHILLAS METÁLICAS

Modelo	Referencia	Concepto	Modelos en que se monta	P.V.P. Euros	P.V.P. €+IVA
	512762980	Cuchilla 30 cm	MICRO COMPACT 300 PLUS MC 300 PLUS	10,36	12,02
	511835780	Cuchilla 33 cm	TURBO LITE 330 TURBO COMPACT 330	16,90	19,61
	511827680	Cuchilla 33 cm	POWER COMPACT 330	18,59	21,56
	511843680	Cuchilla 38 cm	TURBO COMPACT 380	19,38	22,48
	511827787	Cuchilla 40 cm	POWER COMPACT 400	19,38	22,48
	511864780	Cuchilla 40 cm	TURBO 400 - TURBO LITE 400	17,38	20,16

CUCHILLAS PLÁSTICAS

	512750087	Cuchilla plástica x 6	MINIMO E25 - MINIMO S MINIMO PLUS XE - E30	4,84	5,61
	512755787	Cuchilla plástica x 6	MICRO COMPACT 30 - MC30	5,37	6,23
	513846980	Cuchilla plástica x 6	MICRO LITE	4,16	4,82

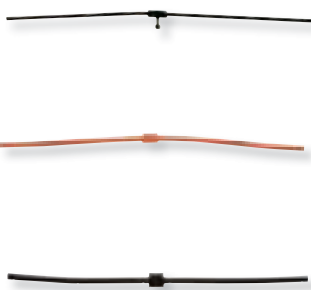

HILOS DE CORTE

	513843487	Hilo nylon x 10	MINI TRIM	5,24	6,07
	513840080	Hilo nylon x 10	GARDEN VAC PLUS LEAF SHREDDER GARDEN VAC LEAF SHREDDER	6,42	7,45
	513859387	Hilo nylon x 10	GARDEN VAC 1500 GARDEN VAC 1600 GARDEN VAC 2200 GARDEN VAC 2600	4,80	5,56

CARRETE CON HILO / BOBINA HILO

	513937190	Carrete con hilo 2 salidas 10 m	TWISTN EDGE / CONTUR MINI TRIM AUTO / MINI TRIM AUTO + MULTI TRIM 250D / 250 DX MULTI TRIM 300D / 300 DX REVOLUTION 2000 / 2300 / 2500	7,65	8,87
	514843787	Bobina nylon 20 m ø 1,5 mm	BOBINA NYLON REPUESTO 20 m - ø 1,5 mm	4,16	4,82
	513765187	Carrete con hilo 10 m	MINI TRIM AUTO MULTI TRIM 200 / 250 / 300 MULTI TRIM CT 250 - MULTI TRIM 300 MULTI TRIM REVOLUTION 2000 / 2300 / 2500	4,16	4,82

ARANDELA ESPACIADOR

Modelo	Referencia	Concepto	Modelos en que se monta	P.V.P. Euros	P.V.P. €+IVA
	513624087	Arandela espaciador x 2	E MINIMO - MINIMO S - MINIMO SX - SPRINTER E25 TWIN E25 - MINIMO TWIN - MINIMO PLUS XE XE 25 - HOVERTRIPERS RXE 250 - SPRINTER E30 E30 - E30 TWIN - XE 30 - XE 28 - GLE - GLE S DXE - HOVERTRIFE RXE 300 - E47 - DLE DLE TWIN - GTE	3,90	4,52
	513811087	Arandela espaciador x 2	E25 - E250 - SPRINTMASTER XE 250 - XE 250 HOVERSTRIPE RXE 250 - MINIMO PLUS XE MINIMO PLUS DLE - DLE-S - SPRINTER E30/E300 - E30 E30S - SPRINTMASTER XE30/XE300 - XE 30 XE 300 - HOVERSTRIPE RXE300 - HOVERVAC HV 300 TURBO COMPACT 300/TC300 - MICRO COMPACT 300 PLUS MC300 PLUS - SPRINTER E38 TWIN - E38 - E38S SPRINTMASTER XE38 TWIN - XE 400 - HOVERVAC HV4000 HOVERTRIPERS - E47 - E47S - XE47S - E52S	4,53	5,26

VARIOS

	513828880	Conector cables	TODOS LOS MODELOS	10,50	12,18
	511840080	Rueda de repuesto	GARDENVAC 1500 PLUS GARDENVAC 1600 PLUS GARDENVAC 2200 PLUS GARDENVAC 2500 PLUS	12,50	14,50
	511835400	Bote combustible 2 Tiempos	L 400 - L 470	3,95	4,59

ACCESORIOS

	964645601	Kit cuerda suspensión cortacéspedes	FLYMO HVT52	250,00	290,00
---	-----------	-------------------------------------	-------------	--------	--------

CAMON



PERUZZO



MOTOSIERRAS ELÉCTRICAS

Modelo	Referencia	Cilindrada Potencia	Peso*	Longitud barra	P.V.P. Euros	P.V.P. €+IVA
	C1800W 874660 Novedad	1.800 W	4,3 Kg.	16" - 40 cm.	99,14	115,00

MOTOSIERRAS DE GASOLINA

Modelo	Referencia	Cilindrada Potencia	Peso*	Longitud barra	P.V.P. Euros	P.V.P. €+IVA
	CMS42 AC310518 Novedad	42 cc 1,25 KW 1,7 HP	6,5 Kg.	18" - 45 cm.	221,55	257,00

CORTACÉSPEDES ELÉCTRICOS

Modelo	Referencia	Corte	Recogedor	Peso	Carcasa	Motor	P.V.P. Euros	P.V.P. €+IVA
	SP33E Novedad	Ancho 32 cm Alturas 5 20-55 250 m ²	36 litros	12 Kg.	ABS	800 W	86,21	100,00
	SP40E Novedad	Ancho 40 cm Alturas 5 20-55 500 m ²	40 litros	17 Kg.	ABS	1.300 W	137,93	160,00

CORTACÉPEDES DE GASOLINA SIN TRACCIÓN

Modelo	Referencia	Corte	Recogedor	Peso	Carcasa	Motor	P.V.P. Euros	P.V.P. €+IVA
	SP41B RASOR Novedad	Ancho 40 cm Alturas 5 20-65 800 m ²	45 litros	23 Kg.	Acero	B&S 3,5 HP	255,17	296,00

CORTACÉPEDES CAMON CON TRACCIÓN TRASERA

Modelo	Referencia	Corte	Recogedor	Peso	Carcasa	Motor	P.V.P. Euros	P.V.P. €+IVA
	SP46 SH RASOR Novedad	Ancho 46 cm Alturas 5 20-65 1.200 m ²	45 litros	31 Kg.	Acero	Honda GCV134	395,69	459,00
	M45GCV135	Ancho 45 cm Alturas 5 1500 m ²	45 litros	45 kg	Aluminio	Honda GCV 135 4,5 HP	489,66	568,00

CORTACÉSPEDES CAMON CON VARIADOR DE VELOCIDAD Y RUEDAS DE ALUMINIO

	M 56CDB6	Ancho 53 cm Alturas 7 Centralizadas 2000 m ²	70 litros	52 Kg	Aluminio	B&S XTS 6 HP	695,69	807,00
	M 56GC160	Ancho 53 cm Alturas 7 Centralizadas 2000 m ²	70 litros	52 Kg	Aluminio	Honda GCV 160 5,5 HP	793,10	920,00

CORTACÉSPEDES CAMON DE ACERO INOXIDABLE

	GT 53 SB	Ancho 52 cm Alturas 20-65 Centralizadas 1500 m ²	58 litros	36 Kg	Acero inox.	B&S 6 HP	582,76	676,00
	GT 53 SH	Ancho 52 cm Alturas 20-65 Centralizadas 1500 m ²	58 litros	36 Kg	Acero inox.	Honda GCV 160 5,5 HP	650,00	754,00

GASOLINA CON CORTE HELICOIDAL

Modelo	Referencia	Ancho de trabajo	Recogedor	Peso	Motor	P.V.P. Euros	P.V.P. €+IVA
	500 H Novedad	Ancho 50 cm Alturas 7-30	60 Litros	63 Kg	Honda GC135	1.464,66	1.699,00

ESCARIFICADOR CAMON

Modelo	Referencia	Ancho de trabajo	Altura de trabajo	Peso	Motor	P.V.P. Euros	P.V.P. €+IVA
	OSCAR 50 H	50 cm	Regulable	65 kg	Honda GX 160 5,5 HP	901,72	1.046,00

TRACTOR CORTACÉSPED

Modelo	Referencia	Características	P.V.P. Euros	P.V.P. €+IVA
	PICCOLO TEC010367	Motor/Potencia: B&S / 10,5 HP Ancho de corte: 67 cm Nº de cuchillas: 1 Descarga: trasera Transmisión: mecánica Velocidades: 5 adelante - 1 atrás Alturas de corte: 30-90 mm Embrague cuchillas: manual Recogedor: 130 litros Tipo de chasis: acero Arranque eléctrico Superficie recomendada: 4.000m ² Peso: 145 kg	1699,14	1971,00
	TWIN 2000 Novedad	Motor/Potencia: B&S / 14,5 HP Ancho de corte: 102 cm Nº de cuchillas: 2 Descarga: trasera Transmisión: mecánica Velocidades: 5 adelante - 1 atrás Alturas de corte: 30-90 mm Embrague cuchillas: eléctrico Recogedor: 220 litros Tipo de chasis: acero Arranque eléctrico Superficie recomendada: 6.000m ² Peso: 218 kg	2.836,21	3.290,00

ACCESORIOS CORTACÉSPEDES CAMON

Modelo	Referencia	Descripción	45CD0	47CD0	56CDB6	566C160	P.V.P. Euros	P.V.P. €+IVA
	MA045013	Cuchilla 430 x 55 x 3	X				13,40	15,54
	MA047013	Cuchilla 460 x 55 x 4		X			13,90	16,12
	MA056012	Cuchilla 525 x 55 x 4 con aleta			X	X	23,90	27,72
	MA056013	Cuchilla 525 x 55 x 4			X	X	15,50	17,98
	MA047829	Correa Z29 1/2	X				5,90	6,84
	MA047827	Correa Z27 1/2		X			5,15	5,97
	MA047725	Correa Z25 (Polea D. 60)			X	X	5,90	6,84
	MA047716	Correa Z16 (Polea D. 60)			X	X	4,95	5,75
	MA050108	Rueda delantera DX/SX (plástica)	X	X	X	X	9,50	11,02
	MA056113	Rueda delantera DX/SX (aluminio)			X	X	24,90	28,88
	MA050118	Rueda trasera DX/SX (plástica)	X	X			17,95	20,83
	MA056123	Rueda trasera DX/SX (aluminio)			X	X	33,25	38,57
	MA047083	Saco tela	X	X			24,90	28,88
	MA050083	Saco tela			X	X	26,90	31,20
	MA047078	Soporte metálico	X	X			15,90	18,44
	MA050078	Soporte metálico			X	X	17,95	20,82
	MA045088	Tracción completa	X				85,80	99,53
	MA047088	Tracción completa		X			85,80	99,53
	MA056089	Tracción completa			X	X	159,90	185,48

CABLES CORTACÉSPEDES CAMON N° serie anterior 0408500

Modelo	Referencia	Descripción	GT 45 B&S	GT 45 GCV 135	GT 47 B&S	GT 53 SB XTS	GT 53 SH	GT 56 XTS 60	GT 56 GCV 160	P.V.P. Euros	P.V.P. €+IVA
	MA047143	Mando+Cable gas	X		X	X				3,95	4,58
	MA053142	Mando+Cable gas		X			X			3,95	4,58
	MA056143	Mando+Cable gas							X	3,95	4,58
	MA050143	Mando+Cable gas						X		3,95	4,58
	MA050139	Cable tracción	X	X		X	X	X	X	9,50	11,02
	MA042148	Cable freno		X			X			5,90	6,84
	MA047148	Cable freno	X		X	X				5,90	6,84
	MA050148	Cable freno						X		5,90	6,84
	MA056148	Cable freno							X	5,90	6,84
	MA056153	Cable variador						X	X	7,90	9,16

CABLES CORTACÉSPEDES CAMON N° serie posterior 0408500

Modelo	Referencia	Descripción	GT 45 B&S	GT 45 GCV 135	GT 53 SB XTS	GT 53 SH	GT 56 XTS 60	GT 56 GCV 160	P.V.P. Euros	P.V.P. €+IVA
	MA047143	Mando+Cable gas	X		X				3,95	4,58
	MA053142	Mando+Cable gas		X		X			3,95	4,58
	MA056143	Mando+Cable gas						X	3,95	4,58
	MA050143	Mando+Cable gas					X		3,95	4,58
	MA052138	Cable tracción	X	X	X	X	X	X	10,25	11,89
	MA046148	Cable freno	X		X				6,95	8,07
	MA046149	Cable freno					X		6,95	8,07
	MA052146	Cable freno						X	6,95	8,07
	MA052149	Cable freno		X		X			6,95	8,07
	MA056153	Cable variador					X	X	7,90	9,16

CORTASETOS ELÉCTRICO

	C580W 875390 Novedad	500 W	Longitud de corte 51 cm. Separación entre cuchillas 20 mm.	3,3 Kg	56,03	65,00
---	-------------------------------------	-------	---	--------	-------	-------

CORTASETOS GASOLINA KENDO CON MOTOR DE 2 TIEMPOS

	NH 26 C 876290	25,4 cc	Doble hoja Longitud de corte 76 cm. Empuñadura regulable en 5 posiciones a 180°	6 Kg	360,34	418,00
---	---------------------------	---------	--	------	--------	--------

SEGADORA DE PEINE SEP

Modelo	Referencia	Motor	Ancho trabajo	Velocidades	Observaciones	Peso	P.V.P. Euros	P.V.P. €+IVA
	BC90 GC160 DS	Honda GC 160	95 cm	1+1	Enganche rápido de aperos	-	consultar	consultar

REBORDEADOR ELÉCTRICO

Modelo	Referencia	Cilindrada	Herramientas de corte standard	Peso	P.V.P. Euros	P.V.P. €+IVA
	W250A 872010 Novedad	250 W	Cabezal de hilo	1,2 Kg	30,17	35,00











DESBROZADORAS DE GASOLINA

	P-410 M 873070 Novedad		Arnés Cabezal de hilo Disco		394,83	458,00
	C-26M 875030	25,4 cc	Arnés Cabezal de hilo Disco	5,8 kg	214,66	249,00
	C-34M 875040	33,6 cc	Arnés Cabezal de hilo Disco	6,8 kg	252,59	293,00

ACCESORIOS CAMON Y BLUEBIRD

Modelo	Referencia	Descripción	P.V.P. Euros	P.V.P. €+IVA
	AI721260	Grupo fresa ZP275 ancho de trabajo 110-220 mm diámetro grupo 275 mm Modelos: R41-R47-R54-R59-P410 C26M-C34M	160,00	185,60

MATERIAL ZOOTÉCNICO

Modelo	Referencia	Descripción	P.V.P. Euros	P.V.P. €+IVA
	S0000MK80	Pastor MK80 y pila	104,31	121,00
	S0000C9000	Pastor eléctrico Corral 9000 (para conectar a la red)	140,52	163,00
	S7430	Bobina hilo 250 m (Recintos eléctricos)	6,90	8,01
	S7435	Bobina hilo 500 m (Recintos eléctricos)	13,90	16,13
	S7400	Aislador para madera (Tira fondo)	0,20	0,23
	S7405	Aislador para hierro (con tuerca)	0,25	0,29
	S7418	Aislador varilla redondo \varnothing 14 mm	0,25	0,29
	S0019	Pila para MK 80 8,4 v. 65 AH Medidas: Largo: 180 / Ancho: 106 / Alto: 112 (mm)	13,98	16,22
	S0019B	Pila No440 8,4 v. 130 AH Medidas: Largo: 180 / Ancho: 120 / Alto: 160 (mm)	18,95	21,98
	S7480	Cable rojo	2,45	2,84
	S7485	Cable negro	1,25	1,45

MOLINOS DE CEREALES ELÉCTRICOS

Modelo	Referencia	Descripción	P.V.P. Euros	P.V.P. €+IVA
1	PE01001000	1.- Molino MILLY 1,5 cv (3 pies) 4 cribas ø 2, 3, 4, 6 mm	193,97	225,00
2	PE01002000	2.- Molino MILLY 1,5 cv (Bidón 20 L) 4 cribas ø 2, 3, 4, 6 mm	168,10	195,00
3	PE01003000	3.- Molino MILLY 1,5 cv (Bidón 50 L) 4 cribas ø 2, 3, 4, 6 mm	193,97	225,00

ACCESORIOS MOLINOS

Modelo	Referencia	Descripción	P.V.P. Euros	P.V.P. €+IVA
1	PE01002005	1.- Bidón 20 litros Metálico	22,90	26,58
2	PE01003005	2.- Bidón plástico 50 litros	31,90	37,00
3	PE38010032	3.- Escobilla antigua (anterior a 1997)	5,25	6,09
4	PE38010035	4.- Escobilla moderna (posterior a 1998)	6,90	8,00
5	PE01001020	5.- Cuchilla Milly	6,90	8,00
6	PE38010030	6.- Motor Milly 1,6 HP	105,00	121,80
	PE01001025	7.- Criba ø 0,8 mm	16,50	19,14
	PE01001030	7.- Criba ø 1 mm	17,50	20,30
	PE01001040	7.- Criba ø 2 mm	15,90	18,45
	PE01001045	7.- Criba ø 3 mm	14,90	17,28
	PE01001050	7.- Criba ø 4 mm	14,90	17,28
	PE01001055	7.- Criba ø 6 mm	14,90	17,28
	PE01001060	7.- Criba ø 8 mm	14,90	17,28

BOMBAS DE PRESIÓN CON MOTOR ELÉCTRICO CAMON-INTERPUMP

Modelo	Referencia	L/min	Bares	Potencia	Voltios	Amperios	Fases	P.V.P. Euros	P.V.P. €+IVA
	GX 22 Green Jet	7	90	1.75 kw	230	7,5	Monofásica	179,31	208,00
	DS1900M	7,5	130	2,4 kw	220-230	10,9	Monofásica	293,10	340,00
	TX10	9,5	130	3,2 kw	220-230	14,7	Monofásica	715,52	830,00
	TX13	13	180	5 kw	380-400	9,2	Trifásica	715,52	830,00
	IPX10 TOTAL STOP	9,5	130	3,2 kw	220-230	14,7	Monofásica	767,24	890,00
	IPX13 TOTAL STOP	13	180	5 kw	380-400	9,2	Trifásica	767,24	890,00

MOTOBOMBAS 4 TIEMPOS

Modelo	Ref.	Descripción	Entrada Salida	Litros Hora	Altura Metros	Peso Kg	P.V.P. Euros	P.V.P. €+IVA
	SE 38 E Novedad Mayo 2007	Motor 39,6 cc 1,31 KW - 1,76 HP	1"	8100	40m	7	331,90	385,00

MOTOBOMBAS 4 TIEMPOS

Modelo	Ref.	Descripción	Entrada Salida	Litros Hora	Altura Metros	Peso Kg	P.V.P. Euros	P.V.P. €+IVA
	SEH-50X	Motor Honda GX120 Potencia: 4 HP Capacidad depósito: 2.500 cc Altura de aspiración: 8 mts.	2"	36.000	30	26	439,66	510,00
	SEH-80X	Motor Honda GX160 Potencia: 5,5 HP Capacidad depósito: 3.500 cc Altura de aspiración: 8 mts.	3"	60.000	30	34	484,48	562,00

ACCESORIOS BOMBAS DE PRESIÓN CAMON-INTERPUMP

Modelo	Referencia	Descripción	Modelos en que se monta			P.V.P. Euros	P.V.P. €+IVA
			CL22 GX22	TX10	TX13		
	INZP6T7	Pistola + Manguera 7 m. "P6"	•			62,90	72,96
	INZP3X	Pistola automática "P3X"		•	•	27,25	31,61
	IN98401800	Manguera 7 metros	•			42,90	49,76
	INZXTUB08	Manguera 8 metros		•	•	80,59	93,48
	INZXTUB012	Manguera 12 metros (opcional)		•	•	114,25	132,53
	INZZSUP35	Lanza "Quick 4"	•			11,90	13,80
	INZZFIX35	Lanza FIX35		•	•	13,90	16,12
	INZZQUICK35	Lanza Quick 35		•	•	11,90	13,80
	INZVARIO125	Boquilla "VARIOJET" regulador 125	•			18,57	21,54
	INZROTIN135	Boquilla "ROTOCLEAN" regulador 135	•			36,37	42,19
	INZREG4	Boquilla "MULTIREG99" regulador 130		•		27,95	32,42
	INZREG90	Boquilla "MULTIREG99" regulador 135			•	27,95	32,42
	INZROTEK140	Boquilla "ROTOCLEAN" regulador 140		•	•	69,10	80,16
	INZVARIOK125	Lanza con boquilla "VARIOJET KIT"	•			31,93	37,04
	INZROTINK135	Lanza con boquilla "ROTOCLEAN KIT"	•			49,10	56,96
	INZTXREG130	Lanza con boquilla "QUICK35+MULTIREG130"		•		39,60	45,94
	INZTXREG135	Lanza con boquilla "QUICK35+MULTIREG135"			•	39,60	45,94
	INZTXROK140	Lanza con boquilla "QUICK35+ROTOCLEAN140"		•	•	82,57	95,78

ACCESORIOS BOMBAS DE PRESIÓN CAMON-INTERPUMP

Modelo	Referencia	Descripción	Modelos en que se monta			P.V.P. Euros	P.V.P. €+IVA
			CL22 GX22	TX10	TX13		
	INZTXLANCM4	Pistola + lanza + boquilla con MULTIREG 130		•		82,96	96,24
	INZTXLANCM90	Pistola + lanza + boquilla con MULTIREG 135			•	82,96	96,24
	INZTXLANCR1	Pistola + lanza + boquilla con ROTOTEK 140		•	•	119,69	128,82
	INZCHEMKIT	Kit depósito detergente "CHEM KIT"	•			6,81	7,90
	INZFOAMKIT1	Kit lanza para espuma "FOAMKIT 1"	•			42,85	49,71
	INZTXFOAM1	Kit lanza para espuma "FOAMKIT 1"		•	•	46,91	54,42
	INZDRAINKIT1	Kit limpieza de tuberías "DRAINKIT 1"	•			59,46	68,97
	INZTXDRAIN1	Kit limpieza de tuberías "DRAINKIT 1" Longitud: 10 m		•	•	70,47	81,75
	INZSANDKITO	Kit arenador "SANDKITO"	•			55,07	63,89
	INZTXSANDO	Kit arenador "SANDKIT"		•	•	79,34	92,04
	INZBRUSHKIT1	Cepillo rotativo "BRUSHKIT 1"	•			39,00	45,24
	INZTXBRUSH	Cepillo rotativo "BRUSHKIT"		•	•	42,12	48,86
	INZDET	Detergente espumógeno "INTERFOAM" 6 pcs	•	•	•	8,42	9,77

SIERRAS DE PODA EXTENSIBLES A.R.S.

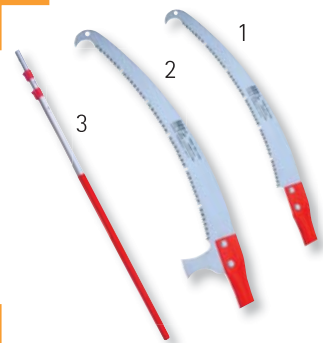
Modelo	Referencia	Herramientas de corte standard	Longitud Total	Peso (gr)	P.V.P. Euros	P.V.P. €+IVA
	UV-34	1.- Sierra para barra extensible	560 mm	220	18,97	22,00
	UV-47	2.- Sierra para barra extensible (supertubo)	670 mm	380	40,95	47,50
	EXP-4.5	3.- Barra extensible sin sierra	1,84 a 4,56 m	1.720	76,72	89,00
	EXP-5.5		2,00 a 5,56 m	2.100	85,34	99,00

TIJERAS DE PODA EXTENSIBLES A.R.S.

	180ZK-3.0-5	Tijera de poda extensible 3 metros	1,8-3 m	1.270	61,21	71,00
	180ZK-2.0-3	Tijera de poda extensible 2 metros	1,25-2 m	1.050	54,55	63,28
	180L-1.8	Tijera de poda fija	1.8 mm	615	54,31	63,00





RECAMBIO TIJERAS DE PODA EXTENSIBLES

180-1	Cuchilla repuesto 180 ZK				12,90	14,96
SP-41	Muelle repuesto manecilla 180 ZK				1,90	2,21
SP-79	Manecilla repuesto 180 ZK				11,51	13,35
SP-105	Fleje mando repuesto 180 ZK-2.0-3				8,25	9,57
SP-106	Fleje mando repuesto 180 ZK-3.0-5				8,25	9,57

NAVAJAS DE PODA A.R.S.

Modelo	Referencia	Características	Largo Total	Peso (gr)	P.V.P. Euros	P.V.P. €+IVA	
	IK-10-R	Navaja pequeña de poda Especial para Bonsais	220 mm	35	7,95	9,22	
	G-17	Chapado en cromo duro Afilado curvo y TurboCut	379 mm	175	15,86	18,40	
	G-17-1	Cuchilla repuesto G-17				9,26	10,74
	GR-17	Chapado en cromo duro Afilado curvo y TurboCut	377 mm	175	15,95	18,51	
	GR-17-1	Cuchilla repuesto GR-17				9,61	11,15

SERRUCHOS DE PODA A.R.S.

Modelo	Referencia	Herramientas de corte standard	Longitud Total	Peso (gr)	P.V.P. Euros	P.V.P. €+IVA
	TL-24	Regulable, Niquelado químico Afilado curvo, Super TURBOCUT Templado por impulso	406 mm	190	25,00	29,00
	TL-24-1	Cuchilla repuesto TL-24			11,73	13,61
	TL-27	Regulable, Niquelado químico Afilado curvo, Super TURBOCUT Templado por impulso	437 mm	200	26,95	31,26
	TL-27-1	Cuchilla repuesto TL-27			12,63	14,65
	UV-32X	Sierra de poda fija Niquelado químico, Super TURBOCUT	535 mm	230	16,29	18,90
	CT-32	Sierra de poda fija Niquelado químico, URBOCUT	525 mm	230	13,00	15,08
	DUKE-25	Sierra de poda fija Afilado curvo, TURBOCUT	250 mm	250	23,28	27,00

TIJERAS DE PODA A.R.S.

	K-900Z	Para setos, arbustos y césped Telescópica, Niquelado químico	720 a 1.050 mm	950	45,69	53,00
	310	Tijera para frutas Hoja curva	160 mm	90	5,90	6,84
	310-T	Tijera para frutas Hoja recta	160 mm	90	6,03	7,00
	300L	Tijera para frutas Hoja recta larga	190 mm	110	6,54	7,59
	310DX	Tijera para frutas Hoja curva, acero inoxidable	170 mm	110	9,96	11,55
	130DX	Para frutales Chapado en cromo duro	184 mm	150	16,90	19,60
	120EU	Para frutales Chapado en cromo duro	210 mm	225	15,90	18,44
	CB-9	Para frutales Niquelado químico	225 mm	230	25,89	30,00
	CBR-8EX				28,45	33,00
	LP-11	Para frutales y viñas Grosor máximo: 36 mm	630 mm	1.265	59,00	68,44
	LP-33L	Para frutales y viñas	642 mm	1.060	43,10	50,00
	LP-40	Para frutales y viñas Grosor máximo: 50 mm	800 mm	1.720	62,93	73,00

LIMA

	9F-10	Lima para afilar serruchos			9,05	10,05
---	-------	----------------------------	--	--	------	-------

CORTADORAS RADIALES DOLMAR CON MOTOR DE 2 TIEMPOS

Modelo	Referencia	Cilindrada	Potencia	Diámetro Disco	Profund. Corte	Accesorios	P.V.P. Euros	P.V.P. €+IVA
	PC6412S	62 cc	3,5 Kw	12"/300 mm	100 mm	Disco abrasivo 12" Eje de 20 mm Arandela 25,4 mm Kit de agua	825,86	958,00
	PC7314S	73 cc	4,2 Kw	14"/350 mm	120 mm	Disco abrasivo 14" Eje de 20 mm Arandela 25,4 mm Kit de agua	919,83	1.067,00

ACCESORIOS DE CORTE EN HÚMEDO

Modelo	Referencia	Descripción	P.V.P. Euros	P.V.P. €+IVA
	D700394354	Carro corte para modelos PC6412 - PC7314	745,00	864,20

CARRETILLA MOTORIZADA

Modelo	Referencia	Motor	Velocidades	Peso	Carga máxima	P.V.P. Euros	P.V.P. €+IVA
	MTRP85835	3,5 HP	1 adelante 1 atrás	56 Kg	100 Kg	728,45	845,00

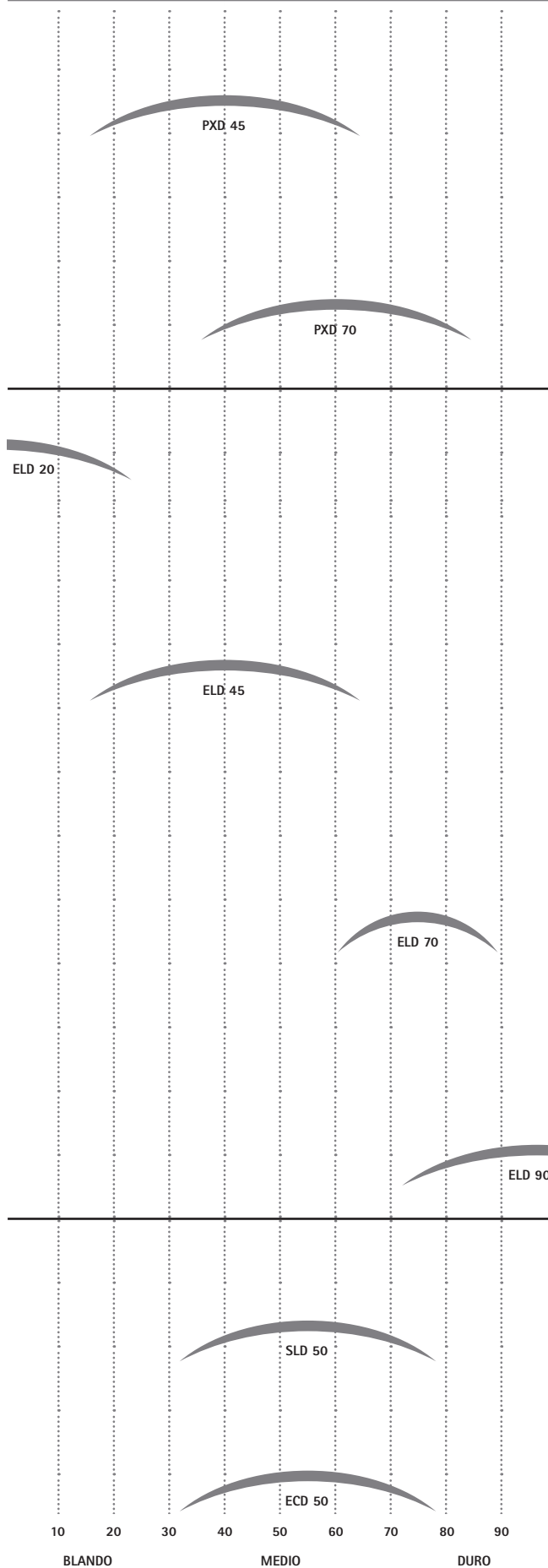

DISCOS DE DIAMANTE

GRANITO	LADRILLO DURO	HORMIGÓN ARMADO	HORMIGÓN DURO	HORMIGÓN GENERAL	CONDUCTOS DE HORMIGÓN	BLOQUES DE HORMIGÓN ABRASIVO	LADRILLO BLANDO	LADRILLO FRESCO	ASFALTO
---------	---------------	-----------------	---------------	------------------	-----------------------	------------------------------	-----------------	-----------------	---------







Referencia	Modelo	P.V.P. Euros	P.V.P. €+IVA
PXD 45			
506 28 16 12	12" / 305 mm	246,40	285,82
506 28 16 16	16" / 405 mm	344,96	400,15
PXD 70			
506 28 17 12	12" / 305 mm	246,40	285,82
506 28 17 16	16" / 405 mm	344,96	400,15
ELD 20			
506 28 18 14	14" / 355 mm	269,81	312,98
ELD 45			
506 28 20 12	12" / 305 mm	210,67	244,38
506 28 20 14	14" / 355 mm	269,81	312,98
506 28 20 16	16" / 405 mm	288,29	334,42
ELD 70			
506 28 24 12	12" / 305 mm	210,67	244,38
506 28 24 14	14" / 355 mm	269,81	312,98
506 28 24 16	16" / 405 mm	288,29	334,42
ELD 90 URC (Asfalto)			
506 28 25 14	14" / 355 mm	269,81	312,89
506 28 25 16	16" / 405 mm	288,29	334,42
SLD 50			
506 28 27 14	14" / 355 mm	178,60	207,18
506 28 27 16	16" / 405 mm	220,00	255,20
ECD 50			
506 28 29 16	16" / 405 mm	141,46	164,09

AHOYADORES BLUE BIRD

Modelo	Modelo Referencia	Características	P.V.P. Euros	P.V.P. €+IVA
	NEA 39E 871140	Cilindrada: 38,6 cc Diámetro: 20 cm Profundidad: 1,20 m (No incluye broca)	439,66	510,00
	NEA 52E 870950	Cilindrada: 51,7 cc Diámetro: 22 cm Profundidad: 1,40 m (No incluye broca)	487,07	565,00

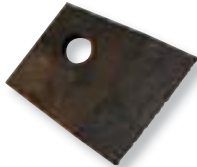
ACCESORIOS AHOYADORES BLUE BIRD

	AI720040 AI720170 AI720350	Broca ø mm - 100 x 800 Broca ø mm - 150 x 800 Broca ø mm - 200 x 800	78,50 81,90 84,55	91,06 95,00 98,08
	AI750360	Extensión de 40 cm	43,95	50,99
	AI600150 AI600170 AI600180	Cuchilla broca ø mm - 100 Cuchilla broca ø mm - 150 Cuchilla broca ø mm - 200	10,10 10,75 11,50	11,72 12,47 13,34
	AI750750	Punta broca	12,30	14,27

BIOTRITURADOR BLUE BIRD

	BIO 2000 874060	Potencia: 2000 W - 230 Volt. Grosor max: 2,5 cm.	204,31	237,00
---	--------------------	---	--------	--------

the 1990s, the number of people in the world who are undernourished has increased from 600 million to 800 million (FAO 2001).

There are a number of reasons for this increase. One of the main reasons is the increase in the world population. The world population has increased from 5 billion in 1987 to 6 billion in 2000, and is projected to reach 9 billion by 2050 (FAO 2001). This increase in population has led to an increase in the demand for food, which has not been met.

Another reason for the increase in undernourishment is the increase in the number of people who are living in poverty. The number of people living on less than \$1 per day has increased from 1.2 billion in 1987 to 1.6 billion in 2000 (FAO 2001). This increase in poverty has led to an increase in the number of people who cannot afford to buy enough food.

A third reason for the increase in undernourishment is the increase in the number of people who are living in rural areas. The number of people living in rural areas has increased from 3.5 billion in 1987 to 4.5 billion in 2000 (FAO 2001). This increase in rural population has led to an increase in the number of people who are dependent on agriculture for their food.

There are a number of ways in which the world can reduce the number of people who are undernourished. One way is to increase the production of food. This can be done by increasing the area of land used for agriculture, by increasing the yield of crops, and by increasing the number of crops that are produced.

Another way to reduce the number of people who are undernourished is to reduce the number of people who are living in poverty. This can be done by increasing the number of jobs, by increasing the minimum wage, and by providing social safety nets.

A third way to reduce the number of people who are undernourished is to reduce the number of people who are living in rural areas. This can be done by providing education and training to people in rural areas, and by providing them with access to other opportunities.

There are a number of other ways in which the world can reduce the number of people who are undernourished. These include increasing the efficiency of food production, reducing food waste, and increasing the number of people who are working in the food industry.

The world has a long way to go in order to reduce the number of people who are undernourished. However, there are a number of things that can be done to help reduce the number of people who are undernourished. These include increasing the production of food, reducing the number of people who are living in poverty, and reducing the number of people who are living in rural areas.

There are a number of other things that can be done to help reduce the number of people who are undernourished. These include increasing the efficiency of food production, reducing food waste, and increasing the number of people who are working in the food industry.

The world has a long way to go in order to reduce the number of people who are undernourished. However, there are a number of things that can be done to help reduce the number of people who are undernourished. These include increasing the production of food, reducing the number of people who are living in poverty, and reducing the number of people who are living in rural areas.













There are a number of other things that can be done to help reduce the number of people who are undernourished. These include increasing the efficiency of food production, reducing food waste, and increasing the number of people who are working in the food industry.

The world has a long way to go in order to reduce the number of people who are undernourished. However, there are a number of things that can be done to help reduce the number of people who are undernourished. These include increasing the production of food, reducing the number of people who are living in poverty, and reducing the number of people who are living in rural areas.















CAMON
ACCESORIOS













FILTROS DE AIRE ADAPTABLES A MOTORES B&S

Modelo	Referencia	Ref. Original	L	A	H	Para motores	P.V.P. Euros	P.V.P. €+IVA
	PB453300	491519 / 399806	219	67	67	10,...12 HP Vertical. Series253700 - 281700	7,50	8,70
	PB455681	393642 / 394018	180	140	50	V-Twin OHV Vanguard	4,00	4,64
	PB455685	493910 / 691667	184	73	60	8,5 - 10,5 - 11,5 HP vertical	5,00	5,80
	PB455687	399968	222	83	64	7 - 8 -11 HP horizontal	12,00	13,92
	PB455684	493909 / 496894	184	73	76	12- 12,5 HP vertical	7,00	8,12
	PB455754	498596 / 690610	90	57	76	Intek 5,5 - 6,5 HP	6,00	6,96
	PB196604	491021	171	76	76	12,5 - 14 HP vertical. Vanguard OHV. Serie 1. Cilindro	9,00	10,44
	PB455686	494586 / 497725	95	57	54	5 HP vertical. Europe OHV	4,00	4,64
	PB192806	394019	244	102	64	16 -18 HP vertical. Series402700 -42170. Bicilindricos	8,00	9,28
	PB455673	270067	140	89	35	4 HP vertical / 100900	6,00	6,96
	PB455674	270447	146	105	38	5 HP vertical / 130900	3,00	3,48
	PB455675	272235	146	92	32	3 - 3,5 HP vertical series 92500 92900 - 95900 - 96500 96900 Sprint & Classic	3,75	4,35
	PB453340	270848	133	102	35	4 HP vertical series 110900 - 111900	5,25	6,09
	PB191371	270579	140	108	35	3 - 3,5 HP vertical series 82500 hasta 82997 92900 - 93500	3,50	4,06



PREFILTROS Y FILTROS DE AIRE ADAPTABLES A MOTORES B&S

Modelo	Referencia	Ref. Original	L	A	H	Para motores	P.V.P. Euros	P.V.P. €+IVA
	PB455764	272477	184	73	60	Prefiltro para nuestro filtro: 455685	7,00	8,12
	PB455699	272403	184	73	76	Prefiltro para nuestro filtro: 455684	5,00	5,80
	PB198483	492889	178	159		Prefiltro para nuestro filtro: 455676	5,00	5,80
	PB198481	491435	120	102		Prefiltro para nuestro filtro: 453296	3,00	3,48
	PB192797	271271 / 272490	180	140	50	Prefiltro para nuestro filtro: 455681	2,25	2,61
	PB455676	491384 / 496077	178	89	38	9 HP OHV Vanguard - 8 HP Industrial	5,00	5,80
	PB197877	494511	178	89	32	5 HP Industrial Plus 133400 5,5 HP Vanguard	5,00	5,80
	PB199273	499486	178	102	38	Intek14 -24 HP	9,00	10,44
	PB453295	397795	160	114	19	3,5 - 4 HP Max serie	4,00	4,64
	PB453297	399877	117	117	19	3,5 HP Quantum	4,00	4,64
	PB453296	491588 / 399959	133	114	19	3 -5 HP horizontal & 3,5 5 HP Quantum	3,50	4,06
	PB453699	805113	178	159	19	12,5 - 14 - 16 HP V - Twin OHV Vanguard	5,00	5,80
	PB800220	710266	213	102	29	Filtro: Vanguard 5 & 9 HP	5,00	5,80



FILTROS DE AIRE ADAPTABLES A MOTORES HONDA

Modelo	Referencia	Ref. Original	L	A	H	Para motores	P.V.P. Euros	P.V.P. €+IVA
	PB453685	17211-890-023 17211-890-013	100	135	70	G300 / G400	9,00	10,44
	PB453683	17210-ZE3-010 17210-ZE3-505 17210-ZE3-000	112	95	93	GX240 / GX340 / GX390	7,50	8,70
	PB453684	17210-ZE2-882 17210-ZE2-822 17210-ZE2-821 17210-ZE2-505	100	90	77	GX240 / GX270	6,00	6,96
	PB453686	17210-ZE1-822 17210-ZE1-821 17210-ZE1-505	102	73	68	GX110 / GX120 / GX140 GX160 / GX200	5,00	5,80
	PB453687	17210-ZE0-822 17210-ZE0-821 17210-ZE0-505	105	75	52	GX110 / GX120	5,00	5,80
	PB453691	170210-ZE7-013 17210-ZE7-003	190	65	45	GXV160	6,00	6,96
	PB453694	17210-ZE8-013 17210-ZE8-003	130	67	79	GXV270 / GXV340 GXV390	6,00	6,96
	PB453248	17211-888-013 17210-ZE6-003	190	60	50	GXV150 / GV200 / GXV120	7,00	8,12
	PB453688	17211-ZA0-702	165	105	42	GX360	10,00	11,60
	PB454122	17211-ZE7-W03	177	62	48	GXV160	8,00	9,28
	PB455876	17210-734-003 17211-ZE7-W010		54	58	GX160	8,00	9,28
	PB800310	17210-734-000 17210-ZE7-W01	175	60	45	GXV160	4,75	5,51
	PB454127	17211-ZG9-M00	146	89	25	GXV140	4,00	4,64





FILTROS DE AIRE ADAPTABLES A MOTORES HONDA

Modelo	Referencia	Ref. Original	L	A	H	Para motores	P.V.P. Euros	P.V.P. €+IVA
	PB454126	17211-ZG9-800	135	60	24	GXV140	5,00	5,80
	PB453296	17211-ZL8-000	133	144	19	GC135 / GC160 GHP135 / GHP160	3,50	4,06



FILTROS DE AIRE ADAPTABLES A MOTORES KAWASAKI

Modelo	Referencia	Ref. Original	L	A	H	Para motores	P.V.P. Euros	P.V.P. €+IVA
	PB453689	11013-2021	178	70	57	12,5 HP FB 460	11,50	13,34
	PB453693	11013-2120 11013-2175	90	60	57	4,5 - 5 HP vertical FC 150 V	7,00	8,12
	PB455698	11013-2151	200	60	25	6 HP FC180	6,00	6,96

FILTROS DE AIRE ADAPTABLES A MOTORES JOHN DEERE

Modelo	Referencia	Ref. Original	L	A	H	Para motores	P.V.P. Euros	P.V.P. €+IVA
	PB191371	AM47949	140	108	35		3,50	4,06
	PB453296	PT15853	133	114	19		3,50	4,06
	PB192806	AM38990	244	102	64		8,00	9,28
	PB453670	M70284	122	68	70	RX75	9,00	10,44
	PB453689	AM101191	178	57	70		11,50	13,34



FILTROS DE AIRE ADAPTABLES A MOTORES JOHN DEERE

Modelo	Referencia	Ref. Original	L	A	H	Para motores	P.V.P. Euros	P.V.P. €+IVA
	PB453693	M79451	102	85	82		7,00	8,12
	PB455703	M92359 AM121608	114	85	71	XTX38	16,00	18,56



FILTROS DE AIRE ADAPTABLES A MOTORES TECUMSEH

Modelo	Referencia	Ref. Original	L	A	H	Para motores	P.V.P. Euros	P.V.P. €+IVA
	PB455748	23410060 / 36745	70	45	45	Centura 5,5 HP	4,00	4,64
	PB191390	23410051 / 35066	45	72	22	TVS - ECV - H35 Spectra 37/40	3,00	3,48
	PB455671	23410030 23410044 35500	182	57	19	TVS75 - 90 - 100 - 105 120 - TVXL105	5,30	6,15
	PB453002	23410001	83	67	57	Ovalado para 2 y 4 tiempos	4,00	4,64
	PB453696	23410012	152	40	35	BV	6,00	6,96
	PB453697	23410026	145	40	30	BVS143 / 153	2,00	3,23
	PB454868	23410061	135	69	32		6,00	6,96
	PB454869	23410028 / 35850	130	57	59	VLV40 - BVL 198	5,00	55,80
	PB454874	36356	185	74	76	OHV14 - 15 - 16 - 17 - 110 115 - 120 - 125 - 130 135 - 140 - 145 - 150 - 155 160 - 165 - 170 - 175	7,00	8,12
	PB454875	35403	203	51	60	OVXL195-200	7,00	8,12



FILTROS DE AIRE ADAPTABLES A MOTORES KOHLER

Modelo	Referencia	Ref. Original	L	A	H	Para motores	P.V.P. Euros	P.V.P. €+IVA
	PB455702	12-083-10	114	83	85	11 - 12,5 - 14 HP	20,00	23,20
	PB455703	12-083-05	114	85	71	11 -12,5 - 14 HP	16,00	18,56

FILTROS DE AIRE ADAPTABLES A MOTORES KUBOTA

Modelo	Referencia	Ref. Original	L	A	H	Para motores	P.V.P. Euros	P.V.P. €+IVA
	PB455706	12681 - 1122-0	200	52	53	5 cv / 5019 - 5021	7,00	8,12
	PB455708	12101 - 1121-0	140	54	43	T150	30,00	34,80
	PB455710	1122-0 - 12681				Prefiltro para nuestro filtro: 455706	2,00	2,32



FILTROS DE ACEITE ADAPTABLES A MOTORES B&S

Modelo	Referencia	Ref. Original	L	A	H	Agujero	Para motores	P.V.P. Euros	P.V.P. €+IVA
	PB455661	492932	76	59	71	19,5	Modelo corto Vanguard de 5 a 14 HP	8,00	9,28
	PB195909	491056	80	86	74	19,5	Modelo largo Vanguard con bomba de aceite y bicilindrico	10,00	11,60
	PB455148	692513					6,5 HP Intek Pro Series 122600 123600	10,00	11,60



FILTROS DE ACEITE ADAPTABLES A MOTORES HONDA

Modelo	Referencia	Ref. Original	L	A	H	Agujero	Para motores	P.V.P. Euros	P.V.P. €+IVA
	PB455662	15400-679-023 15410-MJ0-004	81 81	83 83	63 63	M20x1,5 M20x1,5	Modelo corto Vanguard de 5 a 14 HP Modelos 3810 - 4514 con refr. líquido	8,00	9,28



FILTROS DE ACEITE ADAPTABLES A MOTORES ISEKI

Modelo	Referencia	Ref. Original	L	A	H	Agujero	Para motores	P.V.P. Euros	P.V.P. €+IVA
	PB455662	5663.017.441.00 6213.240.001.00	81	81	63	M20x1,5		8,00	9,28
	PB455663	5490,652,071,00	68	72	63	19,5	SL14	10,00	11,60

FILTROS DE ACEITE ADAPTABLES A MOTORES JOHN DEERE

Modelo	Referencia	Ref. Original	L	A	H	Agujero	Para motores	P.V.P. Euros	P.V.P. €+IVA
	PB455662	AM101378	81	83	63	M20x1,5	Ff912 - 925 - 932 - 935 1145 - F300 - 400	8,00	9,28
	PB455663	AM107423 AM101054	68	72	63	19,5	LX172 - 176 - 178	10,00	11,60
	PB195909	AM101207 AM34770 AM39687	80	86	74	19,5	STX30 - 38 - 316 - 317 318 - 400 - 420	10,00	11,60

FILTROS DE ACEITE ADAPTABLES A MOTORES KAWASAKI

Modelo	Referencia	Ref. Original	L	A	H	Agujero	Para motores	P.V.P. Euros	P.V.P. €+IVA
	PB455663	49065 - 2070 49065 -2075 75 - 76	68	72	53	19,5	FB460V - FC150V - 290V 400V - FC420V - 540V FD620 - FD620D - FE290D 350 - FE350D	10,00	11,60
	PB455664	49065 - 2072	70	76	62	19,5	FB460 - GE4000AS 4500AS - 5000AS	12,00	13,92



FILTROS DE ACEITE ADAPTABLES A MOTORES KOHLER

Modelo	Referencia	Ref. Original	L	A	H	Agujero	Para motores	P.V.P. Euros	P.V.P. €+IVA
	PB195909	52-050-02 277233	80	86	74	19,5	CH11-14-15 / HP15 HP11-12 - PRO K185 K482 - 482S - K532 K582 - K660 K662 - 7KW - K17 - 19 M18 - 19 - 20 - M18S MV16-17-18-19-20 COMMAND OHV 12,5HP Magnum 16-18 HP Hor. Magnum 18 - 20 HP Twin horizontal & vertical	10,00	11,60

FILTROS DE ACEITE ADAPTABLES A MOTORES YANMAR

Modelo	Referencia	Ref. Original	L	A	H	Agujero	Para motores	P.V.P. Euros	P.V.P. €+IVA
	PB455662	119660-35150 119820-35150 129150-35150	81	83	63	M20-1,5	3TN66E-G2 / 3TN66E S-TNA72E-GX+72E-S 3TN82TE-G1 / 3TN82TE G2+82TE-S / 2T72HLE 2T72HLE-S ET72HLE+75HLE 3T84HLE 3T80LE+80LE-S 2T90L-E 3T90LE / 3T84HLEG1 S 3T84HLE-S	8,00	9,28

CARBURADORES PARA MOTORES HONDA

Modelo	Referencia	Descripción	Ref. Original	P.V.P. Euros	P.V.P. €+IVA
	PB160071	Carburador	HONDA GX160	41,50	48,14
	PB200071	Carburador	HONDA GX200	48,00	55,68
	PB240071	Carburador	HONDA GX240	48,00	55,68
	PB270071	Carburador	HONDA GX270	48,00	55,68
	PB340071	Carburador	HONDA GX340	49,00	56,84
	PB390071	Carburador	HONDA GX390	49,00	56,84

CHAVETAS

Modelo	Referencia	Descripción	Ref. Original	P.V.P. Euros	P.V.P. €+IVA
	PB453167	Chaveta volante magnético	61760 / 222698	0,75	0,87
	PB453767	Chaveta volante magnético	610995 / 29410011 / 29410012	0,90	1,04

ARRANCADOR COMPLETO

Modelo	Referencia	Descripción	Ref. Original	Para motores	P.V.P. Euros	P.V.P. €+IVA
	PB801609	Arrancador	28400-zh8-013ZA	HONDA GX120 GX160 - GX200	39,00	45,24
	PB801629	Arrancador	28400-ZE3-W01ZA	HONDA GX340-GX390	42,00	48,72
	PB801670	Arrancador	28400-ZMO-632 ZB	HONDA GCV135 GCV160	25,00	29,00
	PB801671	Arrancador	28400-ZE2-W01ZA	HONDA GX240-GX270	40,00	46,40

ARRANCADOR COMPLETO

Modelo	Referencia	Descripción	Ref. Original	Para motores	P.V.P. Euros	P.V.P. €+IVA
	PB801613	Arrancador	28400-YA0-791	HONDA G200	48,00	55,68
	PB801647	Arrancador	14210090	TECUMSEH VANTAGE 35	28,00	32,48
	PB801663	Arrancador	497830	B&S 5 CV	34,00	39,44
	PB454294	Arrancador	493295 / 497598	B&S QUANTUM EUROPA	39,00	45,24
	PB801679	Arrancador	497680	B&S	39,00	45,24

BOBINAS

Modelo	Referencia	Descripción	Ref. Original	Para motores	P.V.P. Euros	P.V.P. €+IVA
	PB802303	Bobina	397358	B&S 5 HP Horizontal & Vertical	28,00	32,48
	PB802613	Bobina	802574	B&S QUANTUM EUROPA / SPRINT	34,00	39,44
	PB317287	Bobina	496914	B&S 4 HP Horizontal & Vertical	30,00	34,80
	PB317286	Bobina	398811	B&S 16 HP Horizontal & Vertical	34,00	39,44
	PB160120	Bobina	30500-ZE1-043	HONDA GX 160 / 200	17,25	20,01
	PB240120	Bobina	30500-ZF6-W02	HONDA GX 240 / 270 340 / 390	29,00	33,64
	PB318693	Bobina	34443A	TECUMSEH VANTAGE 35	29,00	33,64

DEPÓSITO DE GASOLINA

Modelo	Referencia	Descripción	Ref. Original	Para motores	P.V.P. Euros	P.V.P. €+IVA
	PB809808	Depósito gasolina	17510-ZE1-020ZA	HONDA GX140 - GX 160	54,00	62,64
	PB809839	Depósito gasolina	17510-ZE2-010ZA	HONDA GX240 - GX 270	54,00	62,64
	PB809840	Depósito gasolina	17510-ZE3-010ZA	HONDA GX340 - GX390	54,00	62,64

INTERRUPTORES

Modelo	Referencia	Descripción	Ref. Original	Para motores	P.V.P. Euros	P.V.P. €+IVA
	PB453740	Interruptor ON-OFF			3,05	3,54
	PB453741	Interruptor pulsador			5,45	6,32
	PB453110	Interruptor	21064 - 725 - 0267 44745 - 365402	MURRAY - MTD AMF - AYP	8,25	9,57
	PB454288	Interruptor 5 terminales 3 posiciones	158913 / 145499 18450065 / 1	E.M / AYP CASTELGARDEN	22,00	25,52
	PB453749	Interruptor abrazadera con pulsador			4,75	5,51
	PB000001	Interruptor ON-OFF	36100-ZEI-015 36100-ZH8-W41 36100-883-005	G 100 - 150 - 200 GX1 110 - 140 - 240 270 - 340	4,50	5,22
	PB453746	Llave universal interruptor			1,25	1,45

ACCESORIOS PARA MOTOSIERRAS

Modelo	Referencia	Descripción	P.V.P. Euros	P.V.P. €+IVA
	PB453980	Rompedor de cadena	93,00	107,88
	PB453987	Punzón	6,00	6,96
	PB453986	Yunque	18,00	20,88
	PB453981	Remachadora de cadena	93,00	107,88
	PB453988	Remachador 1/4" y 325"	6,00	6,96
	PB453989	Remachador 3/8" y 404"	6,00	6,96
	PB453911	Afilador universal sin lima	12,90	14,96
	PB453917	Afilador super rápido para el afilado uniforme y de precisión de la cadena, se fija sobre la guía sin desmontar la cadena	33,00	38,28
	PB453937	Afilador de cadena eléctrico. 220 V - 3000 rpm	575,00	667,00
	PB013165	Disco abrasivo para cadenas de paso 1/4" y 0,325" de 145x3x22	17,90	20,76
	PB013166	Disco abrasivo para cadenas de paso 3/8" y 0,404" de 145x4,5x22	17,90	20,76
	PB013167	Disco abrasivo para reguladores de profundidad de todas las cadenas	17,90	20,76
	PB013035	Disco abrasivo para cadenas de paso 1/4" y 0,325" de 105x3x22	19,00	22,04
	PB013039	Disco abrasivo para cadenas de paso 3/8" y 0,404" de 105x4,5x22	19,00	22,04

CADENAS CAMON

Modelo	Referencia	Paso	Eslav	Mod. PARTNER	P.V.P. Euros	P.V.P. €+IVA
	N150C-N-45E	3/8BP 1,3	45 E	P33-MCV331T	7,50	8,70
	N150C-N-50E	3/8BP 1,3	50 E	Otras marcas	9,08	10,53
	N150C-N-52E	3/8BP 1,3	52 E	335-345-350-351-352	9,33	10,82
	N150C-N-55E	3/8BP 1,3	55 E	1640-1840-ES2200	9,92	11,51
	N150C-N-56E	3/8BP 1,3	56 E	1550-1750-1850-1950-401	9,92	11,51
	N150C-N-57E	3/8BP 1,3	57 E	MCV381	9,92	11,51
	N150C-N-60E	3/8BP 1,3	60 E	Otras marcas	9,92	11,51
	N150C-N-62E	3/8BP 1,3	62 E	420 - Fórmula 5000	8,62	10,00
	K250C-K64E	325 1,3	64 E	1650-410-411-4200	10,50	12,18
	K250C-K72E	325 1,3	72 E	461-470-510-511-540-543-4600-5200	11,25	13,05
	A358LM-K-64E	3/8 1,5	64 E	550-650-7000	11,58	13,43
	A358LM-K-68E	3/8 1,5	68 E	660-710-7700 (diente cuadrado)	12,92	14,99
	A358EP-K-68E	3/8 1,5	68 E	660-710-7700 (diente redondo)	12,08	14,01
	A358LM-K-72E	3/8 1,5	72 E	660-710-7700-720-610	13,25	15,37



BARRAS CAMON

ALKO, ALPINA, BOSCH, CASTOR, DOLMAR, ECHO EFCO, HOMELITE, HUSQVARNA, IKRA, JOSU, JONSERED, ZENOAH, MAKITA, OLEO-MAC, OPEM, PARTNET, POULAN, SOLO, TANACA

Modelo	Referencia	Pulg/cm.	Paso	Mod. PARTNER	P.V.P. Euros	P.V.P. €+IVA
	CA1210N1MHC	12"/31	3/8 BP 1,3	P33	13,17	15,28
	CA1410N1MHC	14"/36	3/8 BP 1,3	335-345-350-351-352	13,25	15,37
	CA1610N1MHC	16"/41	3/8 BP 1,3	370-371-385-391-395	14,83	17,20
	CA1810N1MHC	18"/46	3/8 BP 1,3	420-Fórmula 5000	14,92	17,31
	CA1629N155HC	16"/40	3/8 BP 1,3	1640-1840-ES2200	14,92	17,31
	CA1501WK1NKC	15"/38	,325 1,3	410-411-540-4200	18,25	21,17
	CA1801WK1NKC	18"/46	,325 1,3	470-511-540-543-4600-5200	19,92	23,11
	CA1501WKSTC	15"/38	,325 1,5	400-405-450-500	19,92	23,11
	CA1801WKSTC	18"/46	,325 1,5	500-465-495-545	21,50	24,94
	CA1781A264TC	17/43	3/8 1,5	S50-55-550-650-7000	21,50	24,94
	CA1881A268TC	18/46	3/8 1,5	660-710-7700	21,50	24,94
	CA2071A272TC	20"/50	3/8 1,5	610-720	23,17	26,88
	CA2081A272TC	20"/50	3/8 1,5	660-710-7700	23,17	26,88



CAMPANAS - PIÑÓN

Modelo	Referencia	Paso	Descripción	P.V.P. Euros	P.V.P. €+IVA
	CA50940	3/8	350-351-352-370-371-391-401-420	13,90	16,12
	CA61075	,325	405-470	16,90	16,90
	CA50455	,325	500-540-465-465-545-400-543	15,90	18,44

CORONAS - PIÑÓN

Modelo	Referencia	Descripción	P.V.P. Euros	P.V.P. €+IVA
	CASRK27	Corona ,325x7	4,05	4,70
	CASRA18	Corona 3/8x8	4,05	4,70

LIMAS CAMON

	CA75050	Lima redonda ø 4,0 mm 5/32"	0,95	1,10
	CA75070	Lima redonda ø 4,8 mm 3/16"	0,95	1,10
	CA75090	Lima redonda ø 5,1 mm 13/64"	0,95	1,10
	CA75060	Lima redonda ø 5,1 mm 7/32"	0,95	1,10
	CA75100	Lima plana 150 mm 6"	1,95	2,26

MANGOS LIMAS REDONDA

	CA93004-10	Mango madera	1,35	1,57
	PB013370	Mango plástico	0,54	0,63

FUNDAS BARRA

	CA78030	Funda 10" - 14"	1,30	1,51
	CA78031	Funda 16" - 20"	2,16	2,51

KIT LIMADO













	CA8532	3/8 BP 5/32" ø 4 mm	11,19	12,98
	CA8316	,325 3/16" ø 4,8 mm	11,19	12,98
	CA8732	,3/8 7/32" ø 4,5 mm	11,19	12,98

Incluye: lima redonda + mango, lima plana + mango y plantilla de afilado)

SOPORTE ROLLOS CADENA

	Descripción	Referencia	P.V.P. Euros	P.V.P. €+IVA
	Soporte Rollos Cadena	CA82508	45,81	53,14

FILTROS DE GASOLINA

Modelo	Referencia	Referencia Original	int	ext	salida	Para motores	P.V.P. Euros	P.V.P. €+IVA
	PB453808		4-5			Modelo pequeño	1,55	1,80
	PB453851		6,5-8			Modelo grande	1,55	1,80
	PB453885			15	4,8	Nylon. Modelo pequeño	1,90	2,20
	PB453853			20	4,5	Para motosierra modelo grande	2,25	2,61
	PB453852	394358			7,94	B&S	2,60	3,02
	PB389024	125527		15	4,5	WALBRO hasta 33 cc	3,00	3,48
	PB454024	125528			5,2	WALBRO hasta 80 cc	3,60	4,18
	PB454022	503443201		20	3,5	PARTNER - HUSQVARNA, JONSERED - POULAN	2,75	3,19
	PB453854	1115 350 3503		20	6,4	STHIL	2,85	3,31
	PB277159	4112 350 3500				STHIL FS 80	7,00	8,12
	PB455842	49019-2065				KAWASAKI	9,50	11,02
	PB330820					BLUE-BIRD - CAMON PARTNER - MCCULLOCH	3,48	4,04

TUBOS DE GASOLINA

Modelo	Referencia	Descripción	Longitud	Int.	P.V.P. Euros	P.V.P. €+IVA
	PB453098	Tubo gasolina amarillo	10 m	5 mm	15,00	17,40
	PB453145	Tubo gasolina Partner Husquarna-Jonsered	15 m	2,7 mm	16,90	19,60
	PB853874	Tubo gasolina	30 cm	4 mm	1,65	1,91
	PB853875	Tubo gasolina	31 cm	5 mm	1,65	1,91
	PB453825	Tubo gasolina vinilo	10 m	3 mm	11,00	12,76
	PB453826	Tubo gasolina vinilo	10 m	4 mm	12,00	13,92

SELENOIDES

Modelo	Referencia	Descripción	Ref. Original	Marca	P.V.P. Euros	P.V.P. €+IVA
	PB453099	Selenoide	725-1426 21261 / 24285 110832X 1-8817	MTD MURRAY ROPER SNAPPER	10,95	12,70
	PB455838	Selenoide universal 2 bornes			8,50	9,86
	PB453756	Selenoide universal 2 bornes	35510 1752137 / 753539 212655 184251 45071 740207 1700751 1-8604 28-4210 / 47-1910 110162	ARIENS BOLENS GILSON GRASSHOPPER GRAVELY LAWN BOY SIMPLICITY SNAPPER TORO WHELL HORSE	8,50	9,86
	PB453109	Selenoide 1 borne	53716 / 52323 3057700 725-0530 / 725-0771 111674	AMF ARIENS MTD WHEEL HORSE	8,00	9,28
	PB454118	Selenoide	31204-ZA0-003	HONDA	55,00	63,80







LLAVE BUJÍA

Modelo	Referencia	Dimensiones	Descripción	Para motores	P.V.P. Euros	P.V.P. €+IVA
	PB453216	13 x16			2,00	2,32
	PB453217	10 x19			2,00	2,32
	PB453186	19 x13		Partner - Husquarna Josered	2,20	2,55
	PB453220	15 x19			2,20	2,55
	PB453151	19 x 21	Con terminal hembra de 12 mm	B&S	2,40	2,78
	PB453392	19 x 21	Con terminal macho de 3/8	B&S	2,65	3,07
	PB453390	19 x 21	Con punta TORX	STHIL	3,50	4,06
	PB454548	21	Longitud 210 mm		3,00	3,48

BUJÍAS CHAMPION

Modelo	Referencia	Modelo Champion	Medida Llave	Rosca	Longitud rosca	P.V.P. Euros	P.V.P. €+IVA
	PB455554	Bujía CJ6	19 mm	14 mm	9,5 mm	1,95	2,26
	PB455550	Bujía CJ8	19 mm	14 mm	9,5 mm	1,95	2,26
	PB455556	Bujía RDJ8J	16 mm	14 mm	8,3 mm	2,20	2,55
	PB455560	Bujía J19LM	21 mm	14 mm	9,5 mm	1,95	2,26
	PB455562	Bujía N9YC	21 mm	14 mm	19 mm	1,95	2,26
	PB455561	Bujía L82C	21 mm	14 mm	12 mm	1,95	2,26
	PB455551	Bujía L86C	21 mm	14 mm	12 mm	1,95	2,26





CAPUCHÓN BUJÍA

Modelo	Referencia	Descripción	Ref. Original	Para motores	P.V.P. Euros	P.V.P. €+IVA
	PB453226	Capuchón Bujía NGK LB05F	8051		1,40	1,62
	PB453007	Capuchón Bujía			0,90	1,04
	PB453761	Capuchón bujía estándar			2,00	2,32
	PB453763	Capuchón bujía CHAMPION			4,25	4,93
	PB453769	Capuchón bujía	66538	B&S	1,20	1,39
	PB453762	Capuchón bujía BERU - WOLF			3,90	4,52
	PB306001	Capuchón bujía	30600-ZE1-013	HONDA GX - GXV	7,00	8,12

BUJÍAS CAMON

Referencia	Modelo Carlton	Medida Llave	Diam. Rosca	Long. Rosca	Champion	Bosch	Denso	NGK	P.V.P. Euros	P.V.P. €+IVA
CA71010	Bujía CN6E	16	14	8,3	DJ6J	HS5E	TM22M-U	BM7F	1,19	1,38
CA71015	Bujía CN8E	16	14	8,3	DJ8J	HS8E	T20M-U	BM6F	1,60	1,86
CA71025	Bujía CA5Y	19	14	9,5	CJ6Y	WS5F	W22MP-US	BPM7A	1,19	1,38
CA71030	Bujía CA7E	19	14	9,5	CJ6	WS7E	W22M-US	BM7A	1,19	1,38
CA71035	Bujía CA7Y	19	14	9,5	CJ7Y	WS7F	W22MP-U	BPM6A	1,19	1,38
CA71045	Bujía CA8Y	19	14	9,5	CJ8Y	WS8F	W20WP-U	BPM4A	1,19	1,38
CA71055	Bujía C8S	21	14	12	L86C	W8AC	W16FS-U	B5HS	1,19	1,38
CA71060	Bujía C9	21	14	9,5	RJ12C	WR9EC	W14-US	BR6S	1,19	1,38
CA71080	Bujía C11	21	14	9,5	J19LM	WR11EO	W9LMR-US	B2LM CSI	1,19	1,38



MANDO ARRANCADOR

Modelo	Referencia	Descripción	Ref. Original	Para motores	P.V.P. Euros	P.V.P. €+IVA
	PB453700	Mando arrancador	590387 24230009	TECUMSEH	1,20	1,39
	PB011330	Mando arrancador	393152	B&S QUANTUM & EUROPA2 5,5 HP	1,20	1,39
	PB453017	Mando arrancador	66728	B&S	1,20	1,39
	PB453580	Mando arrancador		STHIL	1,10	1,28
	PB453016	Mando arrancador			0,95	1,10



CUERDA ARRANQUE

Modelo	Referencia	Descripción	Longitud	Diámetro	P.V.P. Euros	P.V.P. €+IVA
	CA76005	Cuerda arranque	100 m	2,8 mm	14,00	16,24
	CA76010-1	Cuerda arranque	100 m	3,0 mm	16,95	19,66
	CA76015-1	Cuerda arranque	100 m	3,5 mm	18,50	21,46
	CA76020-1	Cuerda arranque	100 m	4,0 mm	21,00	24,36
	CA76025-1	Cuerda arranque	100 m	4,5 mm	23,95	27,78
	CA76030-1	Cuerda arranque	100 m	5,0 mm	24,95	28,94
	CA76035-1	Cuerda arranque	100 m	5,5 mm	34,95	40,54
	CA76040-1	Cuerda arranque	100 m	6,0 mm	35,90	41,64

CABLE BOBINA

Modelo	Referencia	Descripción	Longitud	Diámetro	P.V.P. Euros	P.V.P. €+IVA
	PB453732	Cable bobina	Cable bobina	ø 5 mm	5,75	6,67
	PB53570	Rollo funda cable	Rollo funda cable	ø ext. 5,5 ø int. 2,6 ø cable 1,6/ 2 mm	24,00	27,84

CABEZALES DE HILO PARA DESBROZADORA

Modelo	Referencia	Descripción	P.V.P. Euros	P.V.P. €+IVA
	PB453555	Cabezal manual con adaptador macho M8x125 rosca izq.	13,00	15,08
	PB453556	Cabezal manual con adaptador hembra F8x125 rosca izq.	13,00	15,08
	PB454955	Cabezal semi-automático diam. Int. 25,4 mm universal	13,00	15,08



BOBINAS NYLON REDONDO CAMON

Modelo	Referencia	Descripción	P.V.P. Euros	P.V.P. €+IVA
	PB541140	15 mts ø 2 mm	2,90	3,36
	PB541170	130 mts ø 2 mm	10,90	12,64
	PB541150	15 mts ø 2,4 mm	2,90	3,36
	PB540810	100 mts ø 2,4 mm	9,95	11,54
	PB541160	9 mts ø 3 mm	2,90	3,36
	PB541210	60 mts ø 3 mm	10,90	12,64
	PB541890	9 mts ø 3,3 mm	2,90	3,36
	PB541900	50 mts ø 3,3 mm	10,90	12,64
	PB541910	100 mts ø 3,3 mm	17,90	20,76
	PB543030	35 mts ø 4 mm	10,90	12,64

DISCOS DESBROZADORA 2 PUNTAS

Modelo	Referencia	Descripción	ø Ext. (mm)	ø Int. (mm)	Grosor (mm)	P.V.P. Euros	P.V.P. €+IVA
	PB031023	Disco de Nylon 2 puntas	255	25,4		3,00	3,48
	PB405810	Disco 2 puntas	255	25,4	2,5	8,00	9,28
	PB405869	Disco 2 puntas	200	25,4	3	7,50	8,70
	PB405840	Disco 2 puntas	300	20	3	7,50	8,70
	PB405842	Disco 2 puntas	300	25,4	3	7,50	8,70
	PB405843	Disco 2 puntas	300	25,4	4	11,00	12,76

DISCOS DESBROZADORA 3 PUNTAS

Modelo	Referencia	Descripción	Ø Ext. (mm)	Ø Int. (mm)	Grosor (mm)	P.V.P. Euros	P.V.P. €+IVA
	PB031024	Disco de Nylon 3 puntas	255	25,4		3,25	3,77
	PB405868	Disco 3 puntas	250	25,4	1,8	10,40	12,06
	PB405800	Disco 3 puntas	250	20	3	10,50	12,18
	PB405801	Disco 3 puntas	250	25,4	3	10,50	12,18
	PB405802	Disco 3 puntas	300	20	3	9,00	10,44
	PB405803	Disco 3 puntas	300	25,4	3	9,00	10,44
	PB405804	Disco 3 puntas	300	20	4	12,00	13,92
	PB405806	Disco 3 puntas	350	20	4	25,90	30,04
	PB405838	Disco 3 puntas	300	20	4	26,00	30,16
	PB405839	Disco 3 puntas	300	25,4	4	24,52	28,44
	PB405818	Disco 3 puntas	300	25,4	2	14,60	16,94

DISCOS DESBROZADORA 36 PUNTAS

Modelo	Referencia	Descripción	Ø Ext. (mm)	Ø Int. (mm)	Grosor (mm)	P.V.P. Euros	P.V.P. €+IVA
	PB020090	Disco 36 dientes en widia	255	25,4	2	24,00	27,84



DISCOS DESBROZADORA 80 PUNTAS

Modelo	Referencia	Descripción	Ø Ext. (mm)	Ø Int. (mm)	Grosor (mm)	P.V.P. Euros	P.V.P. €+IVA
	PB405849	Disco 80 puntas	230	25,4	1,6	20,49	23,77
	PB405898	Disco 80 puntas	250	25,4	2	15,00	17,40





ACCESORIOS VARIOS

Modelo	Referencia	Descripción	P.V.P. Euros	P.V.P. €+IVA
	PB453529	Kit reducción para cabezales desbrozadora	2,75	3,19
	PB453530	Arandela reducción 25,4 mm a 20 mm	1,15	1,33
	PB454946	Protector cabezal diám.10 mm de agujero	3,00	3,48
	PB454945	Protector cabezal diám.8 mm de agujero	3,00	3,48

ACCESORIOS PARA MOTOSIERRA Y DESBROZADORAS

Modelo	Referencia	Descripción	P.V.P. Euros	P.V.P. €+IVA
	PB453309	Visera protección PVC	8,50	9,86
	PB453515	Visera protección con rejilla metálica	8,50	9,86
	PB453576	Casco protector integral	29,00	33,64
	PB273512	Arnés simple	5,90	6,84
	PB453540	Arnés profesional	19,00	22,04

ACCESORIOS PARA MOTOSIERRA Y DESBROZADORAS

Modelo	Referencia	Descripción	P.V.P. Euros	P.V.P. €+IVA
	PB454964	Protege piernas	34,00	39,44
	PB455310	Casco protector oidos 30 dB	5,00	5,80
	PB010656	Casco protector oidos ergonómico 25 dB	3,00	3,48
	PB808703	Kit visera en policarbonato con cascos protectores de oidos incorporados CE	12,00	13,92
	PB808704	Kit visera con rejilla metálica más cascos protectores de oidos incorporados CE	12,00	13,92

PROTECCIÓN EN EL TRABAJO

Modelo	Referencia	Descripción	P.V.P. Euros	P.V.P. €+IVA
	PB455307	Gafas de protección	4,00	4,64
	PB023456	Gafas de seguridad con 4 aieados indirectos CE EN 166	3,00	3,48
	PB453961	Guantes	1,50	1,74
	PB455335	Guantes piel vacuno reforzado talla 10	2,50	2,90
	PB455336	Guantes piel vacuno hidrófugo talla 9	18,00	20,88

PROTECCIÓN EN EL TRABAJO

Modelo	Referencia	Descripción	P.V.P. Euros	P.V.P. €+IVA
	PB455338	Guantes talla 10	6,00	6,96
	PB020045	Guante especial para trabajos de precisión (gran tacto) talla 10	2,60	3,02
	PB455351	Protege botas cuero con velcro	22,00	25,52
	PB020020	Mandil de serraje vacuno 90x60 CE EN470	13,00	15,08
	PB020021	Mandil de serraje vacuno 90x60 CE EN470	13,00	15,08
	PB020022	Manguito hasta el codo de serraje vacuno, elásticos en extremos CE EN470	10,00	11,60
	PB020023	Manguito hasta el hombro de serraje vacuno, unidos por elástico. CE EN470	13,00	15,08
	PB020024	Chaqueta de serraje vacuno. Cierre con velcro CE EN470	56,00	64,96

ROPA DESECHABLE



Referencia	Talla
PB020025	M
PB020026	L
PB020027	XL
PB020028	XXL
P.V.P. Euros	P.V.P. €+IVA
13,00	15,08

Buzo TYVEK PROTECH de Dupont protección química con capucha, cremallera y elásticos CE



Referencia	Talla
PB020029	M
PB020030	L
PB020031	XL
PB020032	XXL
P.V.P. Euros	P.V.P. €+IVA
2,60	3,02

Buzo de polipropileno económico con capucha, cremallera y elásticos CE EN340

ROPA DE ALTA VISIBILIDAD

Modelo	Referencia	Descripción	Talla	P.V.P. Euros	P.V.P. €+IVA
	PB020033 PB020034 PB020035 PB020036	Chaleco ALTA VISIBILIDAD amarillo fluorescente CE EN471 EN340	M L XL XXL	7,00	8,12

Referencia	Talla
PB020037	M
PB020038	L
PB020039	XL
PB020040	XXL

Chaqueta impermeable ALTA VISIBILIDAD amarillo fluorescente CE EN471 EN343 EN340



Referencia	Talla
PB020041	M
PB020042	L
PB020043	XL
PB020044	XXL

Pantalón impermeable ALTA VISIBILIDAD amarillo fluorescente CE EN343 EN 340

BIDONES Y COMPLEMENTOS

Modelo	Referencia	Descripción	P.V.P. Euros	P.V.P. €+IVA
	PB453650	Bidón doble para gasolina (5 litros) y aceite (2,5 litros)	19,00	22,04
	PB484135	Bidón para gasolina 20 litros metálico	25,00	29,00
	PB486531	Bidón para gasolina 10 litros metálico	21,00	22,26
	PB455780	Bidón para gasolina 5 litros metálico	19,00	22,04
	PB455779	Bidón para gasolina 20 litros	15,90	18,44
	PB453659	Bidón para gasolina 10 litros	9,90	11,48
	PB453657	Bidón para gasolina 5 litros	8,90	10,32

Referencia
PB455781

P.V.P. Euros	P.V.P. €+IVA
7,90	9,16

Boquilla embudo

Referencia
PB031477



P.V.P. Euros	P.V.P. €+IVA
10,90	12,64

Boquilla con soporte de fijación para depósito metálico

BATERÍAS

Modelo	Referencia	Descripción	P.V.P. Euros	P.V.P. €+IVA
	PB453323	Batería sin ácido 12N-14-3A 14AH 135x91x169	28,00	32,48
	PB453325	Batería sin ácido 12N-24-3A 24AH 186x125x176	31,00	35,96
	PB453739	Batería sin ácido U1-7 18AH 195x130x180	32,00	37,12
	PB454275	Batería seca 18AH para tractor 180x75x165	42,00	48,72
	PB001864	Ácido para batería 1 litro	4,00	4,64



ÚTILES PARA LEVANTAR TRACTORES

Modelo	Referencia	Descripción	P.V.P. Euros	P.V.P. €+IVA
	PB455500	Útil para levantar tractor	236,00	273,76
	PB000400	Útil para levantar tractor en tubo redondo	147,00	170,52
	PB000350	Elevador lateral para tractor. Elevación total en tan solo 16 vueltas de manivela	157,00	182,12



CUCHILLAS CORTACÉSPEDES PARTNER. HUSQVARNA. ELECTROLUX. AYP

Modelo	Ref. PBL	Modelos	Medidas	Ref. PBL	P.V.P. Euros	P.V.P. €+IVA
	PB405467	421EL-421SEL	Largo: 420 mm Ancho: 60 mm Agujero: 16 mm	511 88 04 00	28,16	32,64
	PB405663	146EL-146 146CD-147CD	Largo: 456 mm Ancho: 75 mm Agujero: 10,2 mm	531 02 01 33	22,00	25,52
	PB405470	150-150D	Largo: 508 mm Ancho: 63 mm Agujero: 16 mm	531 02 01 34	15,00	17,40
	PB405664	153CD	Largo: 530 mm Ancho: 75 mm Agujero: 10,2 mm	516 49 43 04	19,00	22,04

DESCARGA LATERAL PARTNER. HUSQVARNA. ELECTROLUX. AYP

	PB406228	P115 / P11-92 P12-90E P12-90EH P13-90EH	Largo: 460 mm Ancho: 57 mm Agujero: 5 dientes	531 02 06 72	12,00	13,92
	PB406232	P14-105E P15-105 E P16-105 EH P160H	Largo: 535 mm Ancho: 57 mm Agujero: 5 dientes	531 02 06 63	12,00	12,72
	PB406229	P12-95 P12-95E	Largo: 490 mm Ancho: 57 mm Agujero: 5 dientes	532 13 84 97	12,90	12,72

DESCARGA TRASERA PARTNER. HUSQVARNA. ELECTROLUX. AYP. CASTERGARDEN

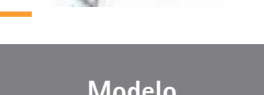
	PB405492	P125HCRD PN.9541200-33 P145HCRD PN.9541200-24	Largo: 465 mm Ancho: 57 mm Agujero: 5 dientes	SX 532 17 00 37	24,00	27,84
	PB405493	P125HCRD PN.9541200-33 P145HCRD PN.9541200-24	Largo: 465 mm Ancho: 57 mm Agujero: 6 dientes	SD 532 17 00 38	24,00	27,84
	PB405489	P145HCRD PN.9541200-34	Largo: 543 mm Ancho: 55 mm Agujero: 5 dientes	SX 532 17 54 50	27,90	32,36
	PB405491	P145HCRD PN.9541200-34	Largo: 543 mm Ancho: 55 mm Agujero: 6 dientes	SD 532 17 54 51	27,90	32,36

Modelo	Ref. PBL	Modelos CASTERGARDEN	Medidas	Ref. Castelgarden	P.V.P. Euros	P.V.P. €+IVA
	PB405876	TCP122	Largo: 620 mm Ancho: 55 mm Agujero: 19 mm	SX 82004342/0	29,00	33,64
	PB405877			DX 82004343/0	29,00	33,64
	PB406275	TCP102	Largo: 520 mm Ancho: 55 mm Agujero: 19 mm	SX 82004340/1	17,00	19,72
	PB406274			DX 82004341/1	17,00	19,72

DX= derecha / SX=izquierda

PORTA CUCHILLAS Y EJES PARTNER, HUSQVARNA, AYP, ROPER

Modelo	Ref. PBL	Descripción	Ref. EM	P.V.P. Euros	P.V.P. €+IVA
	PB454001	Soporte cuchillas	532 12 87 74	23,00	26,68
	PB454003	Eje cuchillas 5 extrías	532137646	23,90	27,72
	PB454174	Eje cuchillas 6 extrías	532165482	40,25	46,69
	PB454004	soporte + eje cuchillas cpl 5 extrías	532130794	35,00	40,60
	PB454173	soporte + eje cuchillas cpl 6 extrías	532165579	59,90	69,48
	PB454288	Llave contacto cpl 5 terminales 3 posiciones	532 15 89 13	22,00	25,52
	PB453774	Juego pastillas freno 30,48X12,45X7,11 mm	TE799021	8,90	10,32

CORREA CUCHILLAS PARTNER, HUSQVARNA, CASTELGARDEN, YP, ROPER

Modelo	Ref. PBL	Descripción	Ref. Castलगarden	P.V.P. Euros	P.V.P. €+IVA
	PB420685	TCP102 Mec/102 Hyd	35065600/0	43,00	49,88
	PB420686	TCP122 Mec/122 Hyd	35065601/0	60,00	69,60
	35065700/0	TC 92 Mec/J92Hyd/HF2114/HF2113/MT545	35065700/0	69,00	80,04
Ref. PBL	Descripción	Ref. EM	P.V.P. Euros	P.V.P. €+IVA	
PB420902	P115/12-90E/12-90EH/13-90EH (36")	531 02 06 76	36,00	38,16	
PB420907	15-105E/15-105EH/16-105EH/P160H (42")	531 02 06 70	33,00	38,28	
PB420398	145HCRD/180HCRD (42")	532 16 91 78	43,00	49,88	
PB420397	145HCRD/180HCRD/ICT13 (36")	532 16 55 55	40,00	46,40	
PB420901	12,5-105E/EH (42")	532 13 09 69	35,00	40,60	

CORREA TRACCIÓN PARTNER, HUSQVARNA, CASTELGARDEN, YP, ROPER

Ref. PBL	Descripción	Ref. EM	P.V.P. Euros	P.V.P. €+IVA	
	PB420488	ICT13/ICT16/125HCRDA Mec.	532 16 56 31	29,00	33,64
PB420372	ICT13/ICT16/145HCRD Hydro	532 16 56 32	23,00	26,68	

EJES PARA CASTELGARDEN

Modelo	Referencia	Descripción	Referencia Original	Modelo	P.V.P. Euros	P.V.P. €+IVA
	TCP82207200/1	Kit eje cuchillas izquierdo	82207200/1	TC 102 / TC 122	79,00	91,64
	TCP82207201/2	Kit eje cuchillas derecho	82207201/2	TC 102 / TC 122	74,00	85,84
	TCP25020800/1	Eje cuchillas izquierdo	25020800/1	TC 102 / TC 122	33,00	38,28
	TCP25020801/2	Eje cuchillas derecho	25020801/2	TC 102 / TC 123	29,00	33,64
	TCP82207202/0	Kit eje cuchillas izquierdo	82207202/0	J 92	69,00	80,04
	TCP82207203/0	Kit eje cuchillas derecho	82207203/0	J 92	69,00	80,04
	TCP84207250/0	Kit eje cuchillas	84207250/0	F72	49,00	56,84
	TCP12139100/0	Chaveta mdia luna para portacuchillas	12139100/0		0,90	1,04

ARANDELAS PARA CUCHILLAS

Modelo	Referencia	Descripción	P.V.P. Euros	P.V.P. €+IVA
	PB171189	Arandela cuchilla hierro 1/2" x 2 - 1/4"	1,15	1,33
	PB171188	Arandela cuchilla hierro 3/8" x 2 - 1/4"	1,15	1,33
	PB171217	Arandela fibra 7/8" x 2 - 5/16"	0,65	0,75
	PB171218	Arandela fibra 1" x 2 - 5/16"	0,55	0,64
	PB171214	Arandela fibra 1/2" x 2 - 5/16"	0,55	0,64
	PB171213	Arandela fibra 3/8" x 2 - 5/16"	0,55	0,64
	PB171215	Arandela fibra 5/8" x 2 - 5/16"	0,55	0,64

CÁMARAS TRACTORES PARTNER, HUSQVARNA, AYP, ROPER, CASTELGARDEN

Modelo	Ref. PBL	Medidas	Ref. EM	P.V.P. Euros	P.V.P. €+IVA
	PB453785	15x600x6	532 05 99 04	8,90	10,32
	PB453753	16x650x8	532 00 81 34	9,90	11,48
	PB453716	18x850/950x8	532 00 71 52	14,90	17,28
	PB454101	20x800/1000x10	531 02 01 87	14,90	17,28

CUBIERTAS TRACTORES PARTNER, HUSQVARNA, AYP, ROPER, CASTELGARDEN

Modelo	Ref. PBL	Medidas	Ref. EM	P.V.P. Euros	P.V.P. €+IVA
	CUBIERTAS TRACTORES 2 PLIS				
	PB453727	13x500x6	532 12 34 10	20,90	24,24
	PB453731	15x600x6	533 30 11 40	23,90	27,72
	PB453196	16x650x8	532 10 62 30	29,90	34,68
	PB453742	18x850x8	532 13 27 03	49,00	56,84
	PB453743	18x950x8	532 12 20 74	49,00	56,84
	CUBIERTAS TRACTORES 4 PLIS				
	PB454103	13x650x6	----	26,90	31,20
	PB454106	16x650x8	----	42,70	49,53
	PB454102	20x800x10	----	49,15	57,02

PASADORES

Modelo	Ref. PBL	Descripción	P.V.P. Euros	P.V.P. €+IVA
	PB453652	Pasador/ Pin 7x42	1,65	1,91
	PB453280	Pasador/ Pin 8x33	1,80	2,09
	PB453281	Pasador/ Pin 8X37	1,65	1,91
	PB453282	Pasador/ Pin 8X40	1,80	2,09
	PB453283	Pasador/ Pin 8X45	1,80	2,09
	PB453284	Pasador/ Pin 10X40	1,90	2,20
	PB453285	Pasador/ Pin 10X45	1,80	2,09
	PB405220	Pasador betas diámetro 2 mm	0,16	0,19

ACCESORIOS PARA TRABAJO EN EL TALLER



Referencia

PB484686

P.V.P. Euros

67,00

P.V.P. €+IVA

77,72

Bomba neumática de grasa



Referencia

PB454855

P.V.P. Euros

99,00

P.V.P. €+IVA

114,84

Aspirador de aceite

Modelo	Ref. PBL	Descripción	P.V.P. Euros	P.V.P. €+IVA
	PB805270	Engrasador 6x100	5,00	5,80
	PB805271	Engrasador 8x125	5,50	6,38
	PB805272	Engrasador 10x100	6,00	6,96
	PB805273	Engrasador 10x150	7,00	8,12
	PB455403	Llave TORX T-27 - Longitud 160 mm	17,00	19,72
	PB455366	Caja herramientas TORX	82,00	95,12
	PB455356	Llave ALLEN nº 4	8,00	9,28
	PB455357	Llave ALLEN nº 5	9,00	10,44
	PB455439	Alargador 25 metros con tambor enrollador Cable H05VV-F 3x1,5	23,00	26,68
	PB453872	Alargador 25 metros 3x1,5	53,00	61,48
	PB484115	Luz portátil	12,00	13,92

ACCESORIOS TRACTORES CORTACÉSPEDES



Referencia	
PB002002	
P.V.P. Euros	P.V.P. €+IVA
250,00	290,00

Remolque metálico basculante con tapas posterior y laterales abatibles. Carga 600 Kg Dimensiones 105x82x32ruedas 16x4.00-8



Referencia	
PB455245	
P.V.P. Euros	P.V.P. €+IVA
230,00	266,88

Remolque PVC con caja basculante para tractor cortacésped. Carga 400 Kg Dimensiones 120x98x32 ruedas 16x4.00-8



Referencia	
PB455201	
P.V.P. Euros	P.V.P. €+IVA
590,00	684,40

Abonadora manual con carga útil de 55 Kg. Cono metálico



Referencia	
PB455202	
P.V.P. Euros	P.V.P. €+IVA
590,00	684,40

Abonadora para arrastre con carga útil de 55 Kg. Cono metálico



Referencia	
PB455225	
P.V.P. Euros	P.V.P. €+IVA
325,00	377,00

Aireador para tractor, peso 25 kg. 107 cm de largo



Referencia	
PB000100	
P.V.P. Euros	P.V.P. €+IVA
369,00	428,04

Rodillo metálico de 100 cm de largo y 40 cm de diámetro. Peso 150 Kg (lleno de agua)

HERRAMIENTAS PARA JARDIN SERIE STANDARD

Modelo	Ref. PBL	Descripción	P.V.P. Euros	P.V.P. €+IVA
	PB004801	Tijera ligera para el corte de la viña	7,00	8,12
	PB004806	Tijera de largo corte para hierbas y arbustos	11,00	12,76

HERRAMIENTAS DE PODA

Modelo	Ref. PBL	Descripción	P.V.P. Euros	P.V.P. €+IVA
	PB009384	Cortarramas profesional con mango	19,00	22,04
	PB009457	Podadora profesional con mango en aluminio	15,00	17,40
	PB009459	Tijera de viña	7,00	8,12
	PB009467	Tijera de poda profesional con mango de aluminio	15,00	17,40
	PB009462	Tijera cortasetos profesional con mango de aluminio	16,00	18,58

HERRAMIENTAS SERIE OLD GARDEN CON MANGOS DE FRESNO BARNIZADO

Modelo	Ref. PBL	Descripción	P.V.P. Euros	P.V.P. €+IVA
	PB806080	Tijera en acero templado para el corte de viña	13,50	15,66
	PB866090	Tijera profesional en acero templado	17,50	20,30
	PB605130	Tijera en acero templado para el corte de la hierba	17,50	20,30
	PB743270	Cortasetos profesional en acero templado	24,50	28,42
	PB904225	Tijera de poda profesional en acero templado	25,90	27,45

HERRAMIENTA ELÉCTRICA LIGERA

	PB837500	Tijeras 1020 3,6 v 75 mm color rojo	65,00	75,40
---	----------	-------------------------------------	-------	-------

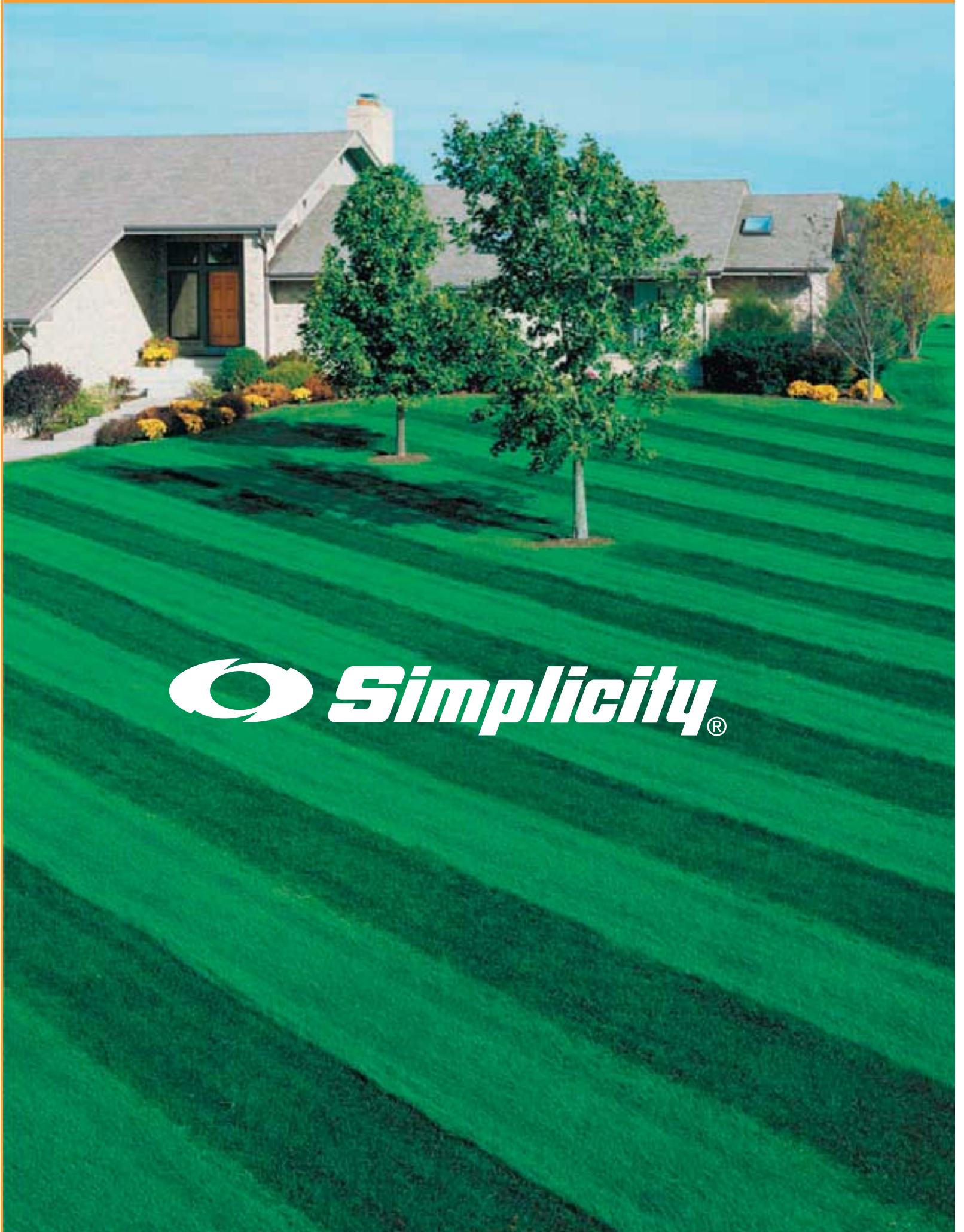

 ***Simplicity***®

TRACTORES CORTACÉSPEDES

Modelo	Referencia	Características	P.V.P. Euros	P.V.P. €+IVA
	CONSUMER Z 2690089	Motor/Potencia: B&S 20 HP Bicilindrico Ancho de corte: 127 cm Nº de cuchillas: 3 Transmisión: hidrostática Alturas de corte: 38 - 115 mm Peso: 312 kg Descarga: Lateral	5.880,00	6.821,00
	REGENT 2690391	Motor/Potencia: B&S 18 HP Ancho de corte: 112 cm Nº de cuchillas: 3 Transmisión: hidrostática Alturas de corte: 38 - 99 mm Peso: 206 kg Descarga: Lateral	3.076,72	3.569,00
IMAGEN NO DISPONIBLE	REGENT 2690591 Novedad	Motor/Potencia: B&S 18 HP Ancho de corte: 102 cm Transmisión: hidrostática Alturas de corte: 38 - 99 mm Carcasa: mulching Peso: 210 kg	3.076,72	3.569,00
	BARON XL 2690338	Motor/Potencia: B&S 20 HP Bicilindrico Ancho de corte: 102 cm Nº de cuchillas: 2 Transmisión: hidrostática Alturas de corte: 25 - 91 mm Peso: 294 kg Descarga: Trasera Recogedor: 325 l.	4.569,83	5.301,00
	LEGACY 2690308	Motor/Potencia: 27 HP Diesel Daihatsu B&S Ancho de corte: 137 mm Nº de cuchillas: 3 Transmisión: hidrostática Alturas de corte: 25 - 127 mm Peso: 295 kg Descarga: Lateral	13.103,45	15.200,00

BRIOTRITURADORES

Modelo	Referencia	Características	P.V.P. Euros	P.V.P. €+IVA
	CHEAPER 1694898	Motor/Potencia: B&S 55 HP Diámetro máx: 6,5 cm. Nº de cuchillas: 2 Martillos: 2 Peso: 44 kg	938,79	1.089,00

ACCESORIOS SIMPLICITY

LEGACY	Referencia	LEGACY	Referencia
	1693706 1694390 1694389		1694486
P.V.P. Euros	P.V.P. €+IVA	P.V.P. Euros	P.V.P. €+IVA
1.507,75	1.749,00	3.527,59	4.092,00



Recogedor con triple bolsa de recogida, y turbo

Cargadora frontal de 122 cm.

LEGACY	Referencia	REGENT	Referencia
	1694508		1694917 1694924
P.V.P. Euros	P.V.P. €+IVA	P.V.P. Euros	P.V.P. €+IVA
195,69	227,00	952,59	952,59

Kit Mulching (Bio Triturado)

Recogedor con doble bolsa de recogida, y turbo

CONSUMER Z	Referencia	CONSUMER Z	Referencia
	1694499 1694304 1692939		1692885
P.V.P. Euros	P.V.P. €+IVA	P.V.P. Euros	P.V.P. €+IVA
1.208,62	1.402,00	195,69	227,00

Recogedor con triple bolsa de recogida, y turbo

Kit Mulching (Bio Triturado)

BARON	Referencia	BARON	Referencia
	1687188		1686972
P.V.P. Euros	P.V.P. €+IVA	P.V.P. Euros	P.V.P. €+IVA
47,41	55,00	94,82	110,00

Tapón Triturar

Deflector

the 1990s, the number of people in the world who are poor has increased. The number of people who are poor in the United States has also increased.

There are many reasons for this. One reason is that the world population has increased. Another reason is that the world economy has not grown fast enough to keep up with the population growth.

There are many things that we can do to help reduce poverty. One thing is to help the world economy grow faster. Another thing is to help the world population grow more slowly.

There are many other things that we can do to help reduce poverty. We can help people who are poor by giving them money. We can help people who are poor by giving them food.

We can help people who are poor by giving them education. We can help people who are poor by giving them jobs.

We can help people who are poor by giving them health care. We can help people who are poor by giving them housing.

We can help people who are poor by giving them clean water. We can help people who are poor by giving them electricity.

We can help people who are poor by giving them transportation. We can help people who are poor by giving them communication.

We can help people who are poor by giving them information. We can help people who are poor by giving them skills.

We can help people who are poor by giving them hope. We can help people who are poor by giving them love.

We can help people who are poor by giving them dignity. We can help people who are poor by giving them respect.

We can help people who are poor by giving them freedom. We can help people who are poor by giving them justice.

We can help people who are poor by giving them peace. We can help people who are poor by giving them happiness.

We can help people who are poor by giving them a better life. We can help people who are poor by giving them a brighter future.

We can help people who are poor by giving them a chance. We can help people who are poor by giving them a dream.

We can help people who are poor by giving them a goal. We can help people who are poor by giving them a plan.

We can help people who are poor by giving them a path. We can help people who are poor by giving them a way.

We can help people who are poor by giving them a hand. We can help people who are poor by giving them a heart.

We can help people who are poor by giving them a voice. We can help people who are poor by giving them a smile.

We can help people who are poor by giving them a life. We can help people who are poor by giving them a love.

There are many things that we can do to help reduce poverty. We can help people who are poor by giving them money. We can help people who are poor by giving them food.

We can help people who are poor by giving them education. We can help people who are poor by giving them jobs.

We can help people who are poor by giving them health care. We can help people who are poor by giving them housing.

We can help people who are poor by giving them clean water. We can help people who are poor by giving them electricity.

We can help people who are poor by giving them transportation. We can help people who are poor by giving them communication.

We can help people who are poor by giving them information. We can help people who are poor by giving them skills.

We can help people who are poor by giving them hope. We can help people who are poor by giving them love.

We can help people who are poor by giving them dignity. We can help people who are poor by giving them respect.

We can help people who are poor by giving them freedom. We can help people who are poor by giving them justice.

We can help people who are poor by giving them peace. We can help people who are poor by giving them happiness.

We can help people who are poor by giving them a better life. We can help people who are poor by giving them a brighter future.

We can help people who are poor by giving them a chance. We can help people who are poor by giving them a dream.

We can help people who are poor by giving them a goal. We can help people who are poor by giving them a plan.

We can help people who are poor by giving them a path. We can help people who are poor by giving them a way.

We can help people who are poor by giving them a hand. We can help people who are poor by giving them a heart.

We can help people who are poor by giving them a voice. We can help people who are poor by giving them a smile.

We can help people who are poor by giving them a life. We can help people who are poor by giving them a love.

We can help people who are poor by giving them a chance. We can help people who are poor by giving them a dream.

We can help people who are poor by giving them a goal. We can help people who are poor by giving them a plan.

We can help people who are poor by giving them a path. We can help people who are poor by giving them a way.



gaima



Gaima, S.A. y el grupo Electrolux tienen una política de desarrollo permanente y se reservan el derecho de modificar en cualquier momento y sin previo aviso las especificaciones de los modelos y otros elementos ilustrados y descritos en este catálogo. Precios válidos salvo error tipográfico.

