

# Panasonic®

Color Video Monitors  
WV-CK1420/2020  
WV-CM1000/1430/1470

B/W Video Monitors  
WV-BM500/503/900/1410/1700/1910



Panasonic video monitors can be used not just in CCTV systems but in a wide range of applications such as for backup monitors at TV stations or in school or business research and development. They have easy-to-view, large screens with clear images in both color and black and white. They are also compatible with the international EIA 19" rack mount standard for easy mounting using a mount that is available separately. The full lineup includes a variety of products that are ideally suited for your applications.



**GET THE CLEAR VIEW WITH PANASONIC  
HIGH RESOLUTION VIDEO MONITORS ON THE BASIS  
OF MORE THAN 30 YEARS OF R&D FOR CCTV INDUSTRY.**

# Color Video Monitors

13" Color AV Monitor

## wv-CK1420



- 13" diagonal actual visual size.
- 370 TV lines h.resolution.
- Looping through BNC connectors for video input and output.
- Looping through RCA connectors for audio input and output.
- Maximum 0.7W for speaker output.

■ Dimensions

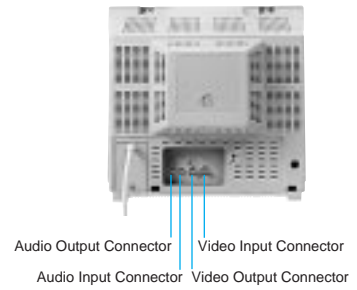
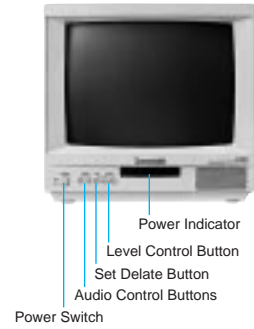
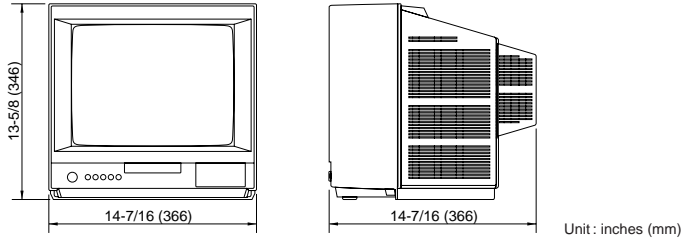

20" Color AV Monitor

## wv-CK2020



- 20" diagonal actual visual size.
- 500 TV lines h.resolutions.
- Looping through BNC connectors for video input and output.
- Looping through RCA connectors for audio input and output.
- Maximum 0.7W for speaker output.

■ Dimensions

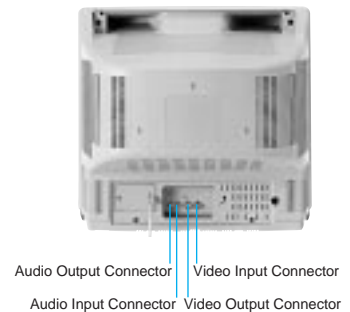
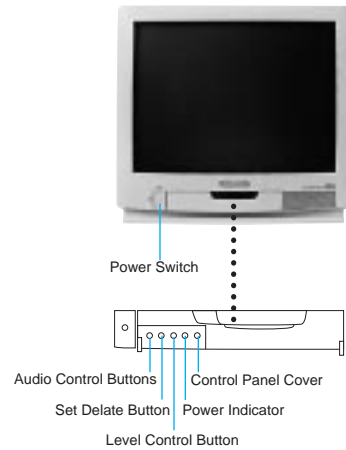
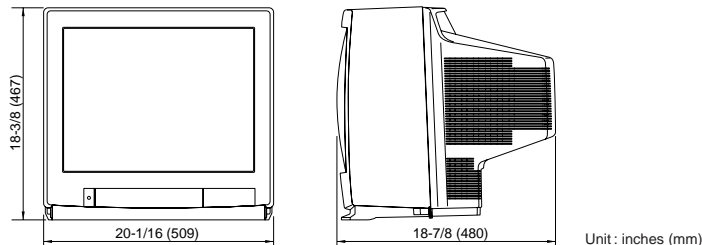



# Color Video Monitors

## 9" Color AV Monitor

# wv-CM1000



- PAL/NTSC/M-NTSC selectable
- H.resolution of 300 lines
- Audio input/output
- Optional adaptor WV-Q52 for EIA 19" rack



### ■ Dimensions

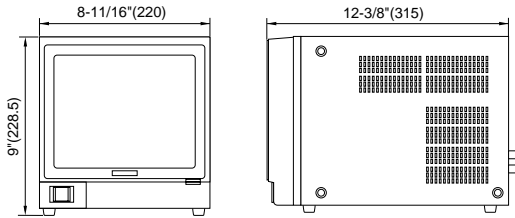

Unit : inches (mm)

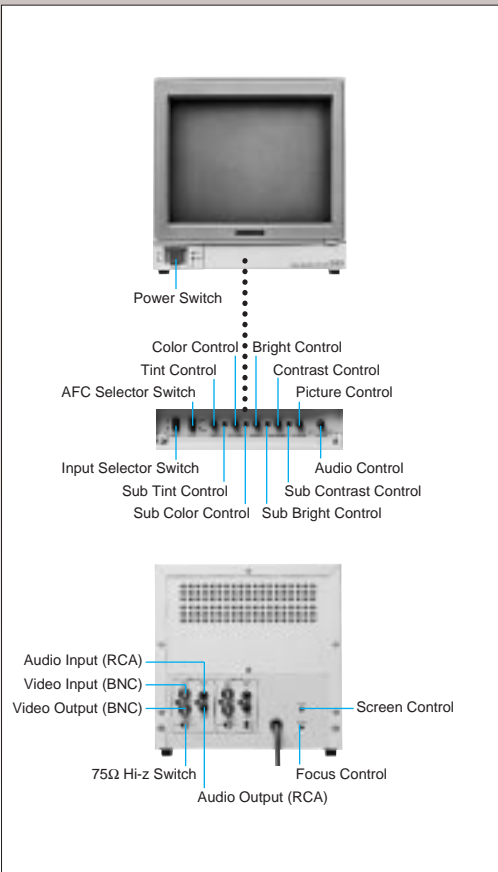

## 13" Color AV Monitor

# wv-CM1430



- H.resolution of 330 lines
- Selectable 2 channels A/B
- 2 loop through Video Audio connectors
- 1W speaker
- Optional adaptor WV-Q104 for EIA 19" rack



### ■ Dimensions

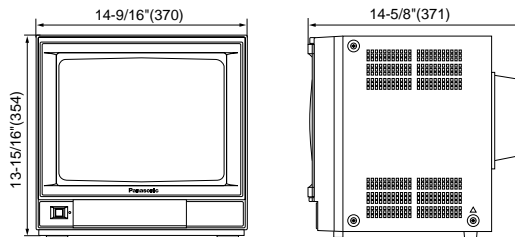

Unit : inches (mm)

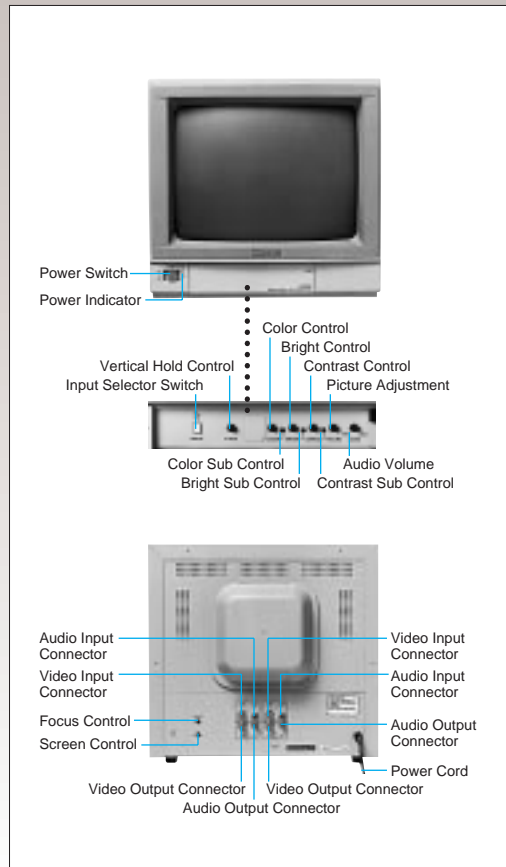

13" Color AV Monitor

# WV-CM1470



- 700 lines of h.resolution. (S-Video).
- Selectable 2 channels A/B.
- 2 loop through Video Audio connectors.
- 0.7W speaker.
- Optional adaptor WV-Q104 for EIA 19"rack.



■ Dimensions

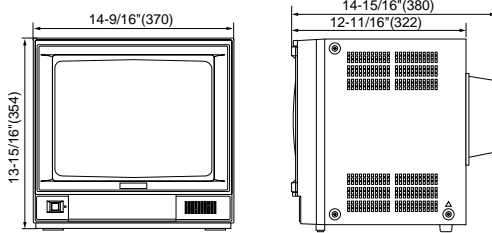

Unit : inches (mm)

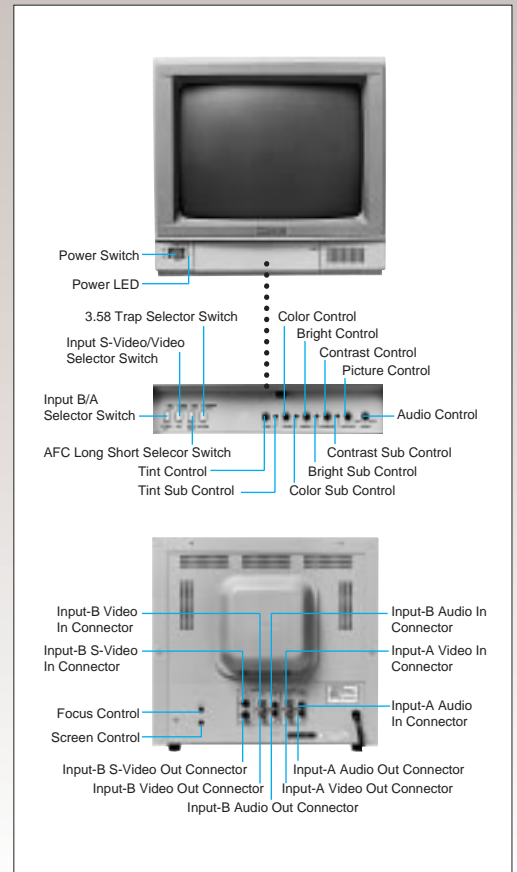

## EIA 19" Standard Rack Mount

Monitors	Mounting Brackets
WV-CM1000 (9" C/L)	WV-Q52 Double/Single Convertible
WV-CM1430 (13" C/L)	WV-Q104 Single
WV-CM1470 (13" C/L)	WV-Q104 Single
WV-BM900 (9" B/W)	WV-Q28 Double/Single Convertible
WV-BM1410 (13" B/W)	WV-Q21W Single
WV-BM1700 (16" B/W)	WV-Q22A Single

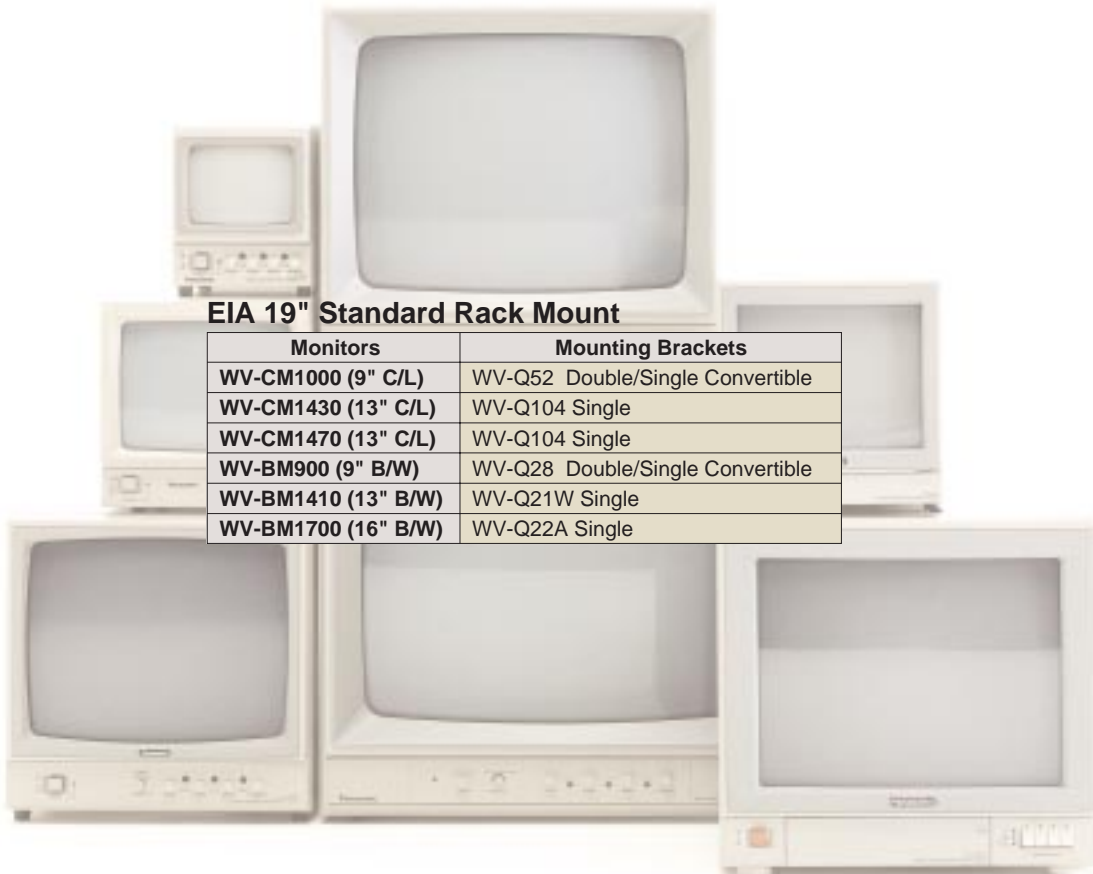

# B/W Video Monitors

5" B/W Video Monitor

## WV-BM500



- Desk-top type
- H.resolution of 700 lines

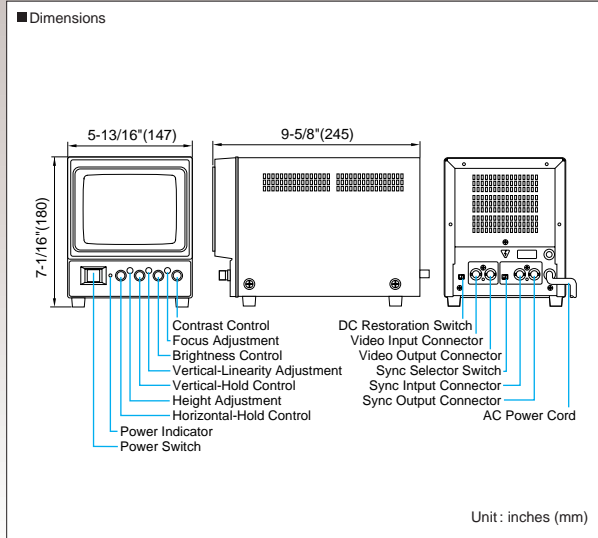

5" B/W Video Monitor

## WV-BM503



- EIA 19" Rack-mounting type
- WV-BM503 combines three WV-BM500.
- H.resolution of 700 lines

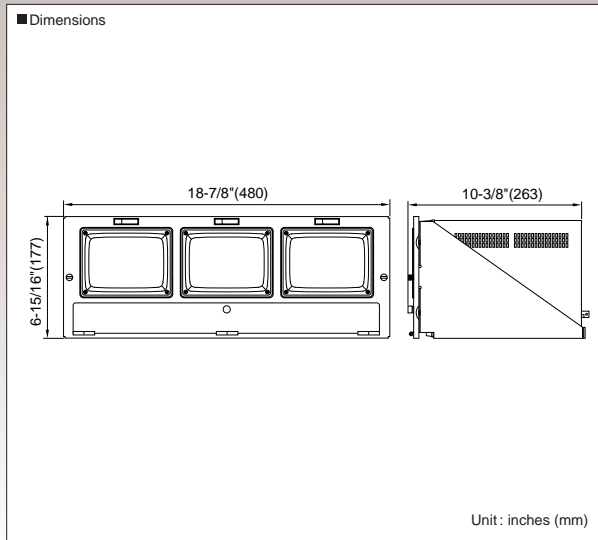

9" B/W Video Monitor

## WV-BM900



- H.resolution of 750 lines
- Optional adaptor WV-Q28 for EIA 19" rack

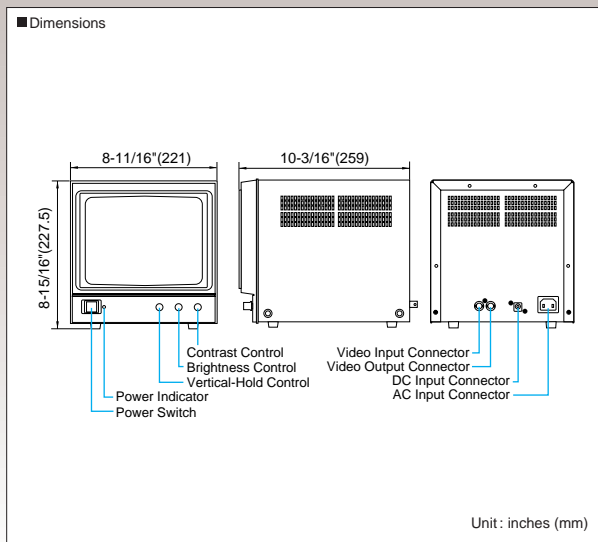

13" B/W Video Monitor

# wv-BM1410



- H.resolution of 1000 lines
- Optional adaptor WV-Q21W for EIA 19" rack

■ Dimensions

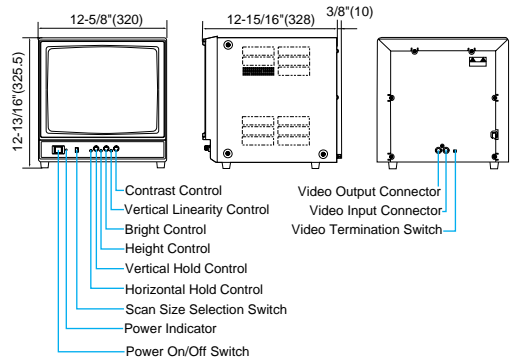

Unit: inches (mm)

16" B/W Video Monitor

# wv-BM1700



- H.resolution of 850 lines
- Optional adaptor WV-Q22A for EIA 19" rack

■ Dimensions

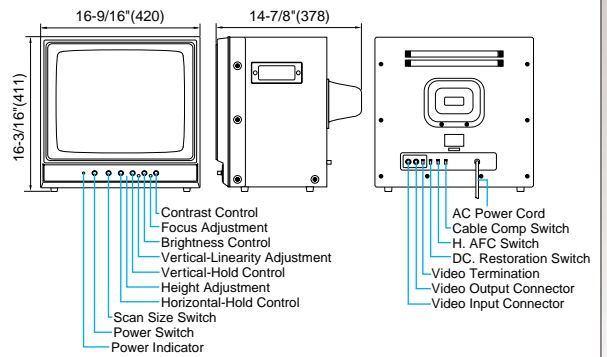

Unit: inches (mm)

19" B/W Video Monitor

# wv-BM1910



- H.resolution of 1000 lines
- DC restoration

■ Dimensions

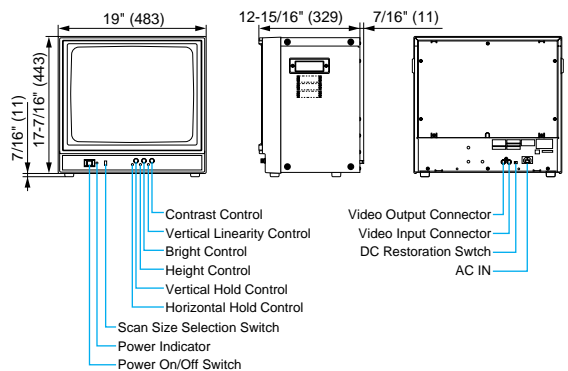

Unit: inches (mm)

# ■ SPECIFICATIONS

## COLOR VIDEO MONITORS

Models	WV-CK1420	WV-CK2020	WV-CM1000	WV-CM1430	WV-CM1470
Power Source	120 V AC, 60 Hz	120 V AC, 60 Hz	100 - 240 V AC, 50/60 Hz	120 V AC, 60 Hz	120 V AC, 60 Hz
Power Consumption	Approx. 75 W	Approx. 75 W	Approx. 49 W	Approx. 57 W	Approx. 70 W
Input/Output	VIDEO (INPUT / OUTPUT)--BNC; 1.0 V [p-p] compsite/75 Ω AUDIO--RCA; -8 dB/Hi-z	VIDEO (INPUT / OUTPUT)--BNC; 1.0 V [p-p] compsite/75 Ω AUDIO--RCA; -8 dB/Hi-z	VIDEO (INPUT: 2 / OUTPUT: 2)--BNC; 1.0 V [p-p] composite/75 Ω or Hi-z looping through AUDIO--RCA; 2 INPUTS Hi-z 2 OUTPUTS	VIDEO (INPUT: 2 / OUTPUT: 2)--BNC; 1.0 V [p-p] composite/75 Ω or Hi-z looping through AUDIO--RCA; 2 INPUTS Hi-z 2 OUTPUTS	VIDEO (INPUT: 2 / OUTPUT: 2)--BNC; 1.0 V [p-p] composite/75 Ω or Hi-z looping through S-VIDEO (INPUT: 1 / OUTPUT: 1) Y; 1.0 V [p-p]/75 Ω or Hi-z looping through C; 0.286 V [p-p]/75 Ω or Hi-z looping through AUDIO--RCA; 2 INPUTS Hi-z 2 OUTPUTS
TV System	NTSC	NTSC	PAL, NTSC, M-NTSC	NTSC	NTSC
Horizontal Resolution	370 TV lines at center	500 TV lines at center	300 lines at center	330 lines at center	700 lines at center (S-Video)
Maximum Video Gain	40 dB ±2 dB	41 dB ±3 dB	34 dB ±3 dB	40 dB ±3 dB	35 dB ±3 dB
Sweep Linearity	Less than 5%	Less than 5%	Less than 5%	Less than 5%	Less than 5%
Sweep Geometry	Less than 2%	Less than 2%	Less than 2%	Less than 2%	Less than 2%
Overcanning	8%	8%	8%	8%	6%
Actual Visual Size (Approx)	13-3/16" diagonal	20" diagonal	8-3/4" diagonal	13" diagonal	13" diagonal
CRT Size (Approx)	14-5/8" (37 cm) diagonal	21-9/16" (55 mm) diagonal	9-13/16" (25 cm) diagonal	14" (37 cm) diagonal	14" (37 cm) diagonal
19" Rack-Mount	No	No	△Yes	△Yes	△Yes
Ambient Operating Temperature	+14 °F ~ +122 °F (-10°C ~ +50°C)	+14 °F ~ +122 °F (-10°C ~ +50°C)	+14 °F ~ +122 °F (-10°C ~ +50°C)	+14 °F ~ +122 °F (-10°C ~ +50°C)	+14 °F ~ +122 °F (-10°C ~ +50°C)
Ambient Operating Humidity	Less than 90%	Less than 90%	Less than 90%	Less than 90%	Less than 90%
Speaker Output	0.7 W	0.7 W	1.0 W (-10 dBV)	1.0 W (-8 dBV)	0.7 W (-8 dBV)
Dimensions W x H x D (inch)	13-7/16" X 13-10/16" X 14-6/16" [366 X 346 X 365 (mm)]	20-8/16" X 18-6/16" X 18-14/16" [509 X 467 X 480 (mm)]	8-11/16" X 9" X 12-3/8" [220 X 228.5 X 315 (mm)]	14-9/16" X 13-15/16" X 14-9/16" [370 X 354 X 371 (mm)]	14-9/16" X 13-15/16" X 14-15/16" [370 X 354.5 X 380 (mm)]
Weight (lbs)	21.2 (9.6 kg)	46.3 (21 kg)	16.2 (7.4 kg)	26.4 (12 kg)	28.6 (13 kg)

## B/W VIDEO MONITORS

Models	WV-BM500	WV-BM503	WV-BM900	WV-BM1410	WV-BM1700	WV-BM1910
Power Source	120 V AC, 60 Hz	120 V AC, 60 Hz	120 V AC, 60 Hz or DC 12 V (2.0 A)	120 V AC, 60 Hz	120 V AC, 60 Hz	120 V AC, 60 Hz
Power Consumption	14 W	42 W	29 W	32 W	45 W	47 W
Actual Visual Size (Approx)	5" diagonal	5" diagonal (each)	8-9/16" diagonal	12-11/16" diagonal	16-1/4" diagonal	18-5/8" diagonal
CRT Size (Approx)	5-3/8" (14 cm) diagonal	5-3/8" (14 cm) diagonal (each)	9-5/16" (24 cm) diagonal	13-3/4" (35 cm) diagonal	17-3/8" (44 cm) diagonal	19-7/8" (51 cm) diagonal
19" Rack-Mount	△Yes	△Yes	△Yes	△Yes	△Yes	No
Video Input	1	3	1	1	1	1
External Sync	Yes	Yes	No	Yes	Yes	No
Horizontal Resolution (at center)	700 lines	700 lines	750 lines	1000 lines	850 lines	1000 lines
Sweep Linearity (less than) (over scan)	5%	5%	5%	5%	5%	5%
Sweep Geometry (less than)	2%	2%	2%	2%	2%	2%
Scanning	Fixed	Fixed	Fixed	Switchable	Switchable	Switchable
Overcanning	5%	5%	5%	6%	5%	6%
Underscanning	No	No	No	5%	5%	No
DC Restoration (switchable)	Yes (Yes)	Yes (Yes)	Yes (No)	Yes (No)	Yes (Yes)	Yes (Yes)
Ambient Operating Temperature	+14 °F ~ +122 °F (-10°C ~ +50°C)	+14 °F ~ +122 °F (-10°C ~ +50°C)	+14 °F ~ +122 °F (-10°C ~ +50°C)	+14 °F ~ +122 °F (-10°C ~ +50°C)	+14 °F ~ +122 °F (-10°C ~ +50°C)	+14 °F ~ +122 °F (-10°C ~ +50°C)
Ambient Operating Humidity	Less than 90%	Less than 90%	Less than 90%	Less than 90%	Less than 90%	Less than 90%
Dimensions W x H x D (inch)	5-13/16" x 7-1/16" x 9-5/8" [147 x 180 x 245 (mm)]	18-7/8" x 6-15/16" x 10-3/8" [480 x 177 x 263 (mm)]	8-11/16" x 8-15/16" x 10-3/16" [221 x 227.5 x 259 (mm)]	12-5/8" x 12-13/16" x 12-15/16" [320 x 326 x 328 (mm)]	16-9/16" x 16-3/16" x 14-7/8" [420 x 411 x 378 (mm)]	19-1/32" x 17-7/16" x 12-31/32" [483 x 443 x 329 (mm)]
Weight (lbs)	5.1 (2.3 kg)	19.8 (9.0 kg)	9.9 (4.5 kg)	22 (10 kg)	33 (15 kg)	44 (20 kg)

△: with optional rack angle bracket

- All TV pictures are simulated.
- Weights and dimensions are approximate.
- Specifications are subject to change without notice.
- These products may be subject to export control regulations.

# Panasonic

Security and Digital Imaging Systems Company

A Division of Matsushita Electric Corporation of America

Executive Office : One Panasonic Way 3E7, Secaucus, New Jersey 07094

Regional Office

Northeast : One Panasonic Way, Secaucus, NJ 07094 (201) 348-7303

Southern : 1225 Northbrook Parkway, Suite 1-160, Suwanee, GA 30024 (770) 338-6838

Midwest : 1707 North Randall Road, Elgin, IL 60123 (847) 468-5211

Western : 6550 Katella Ave., Cypress, CA 90630 (714) 373-7840

PANASONIC CANADA INC.

5770 Ambler Drive, Mississauga, Ontario, L4W 2T3 Canada (905) 624-5010

PANASONIC SALES COMPANY

DIVISION OF MATSUSHITA ELECTRIC OF PUERTO RICO, INC.

San Gabriel Industrial Park 65th Infantry Ave. KM. 9.5 Carolina, P.R. 00630 (809) 750-4300

DISTRIBUTED BY:

VSD-4035 [06284.1] (20k)

Printed in Japan  
[P-366F]