

Madera | wood

**REUNIÓN INDUSTRIAL**  
SOCIEDAD LIMITADA

Fabricación, Distribución y Oficinas en:

Camí L'Horteta 1  
Polígono Industrial  
46138 RAFELBUNYOL  
Valencia  
Tel. 96 141 40 07  
Fax. 96 141 21 48  
clientes@reunion-industrial.com

Workshops, Warehouses & Offices at:

Camí L'Horteta 1  
Polígono Industrial  
46138 RAFELBUNYOL  
Valencia - SPAIN  
Exports Direct: +34 96 141 41 46/7  
TeleFax: +34 96 141 41 48  
info@reunion-industrial.com

www.reunion-industrial.com

Maquetación y diseño, Angel Alonso - Fotografía, Daniel Palacios y Estudio Matisse

333.160  
333.192

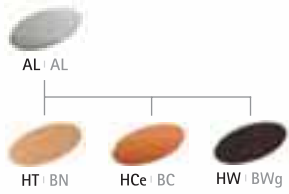
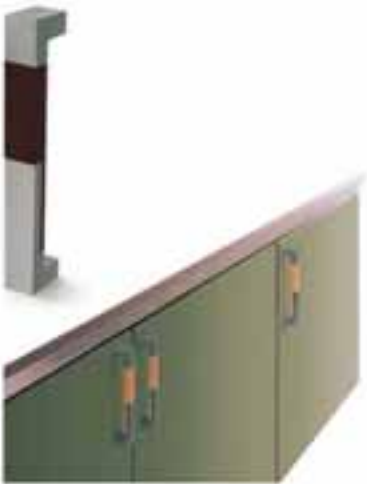
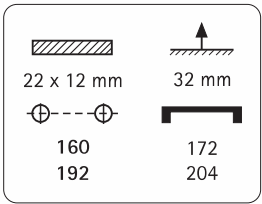
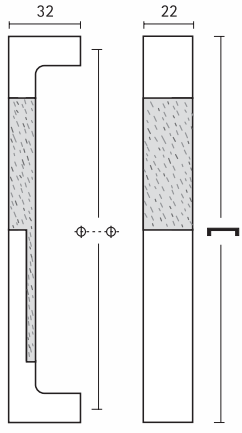

Diseños Designs Angel Alonso  
**Haya y metal**  
*Beech & Metal*

332.160  
332.192

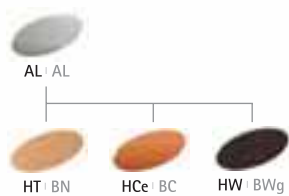
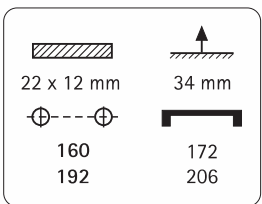
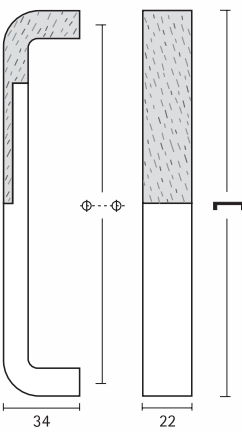

334.064  
334.096  
334.128

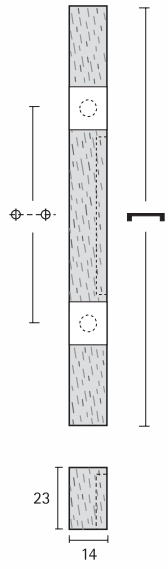

23 x 14 mm	23 mm
64	130
96	175
128	220

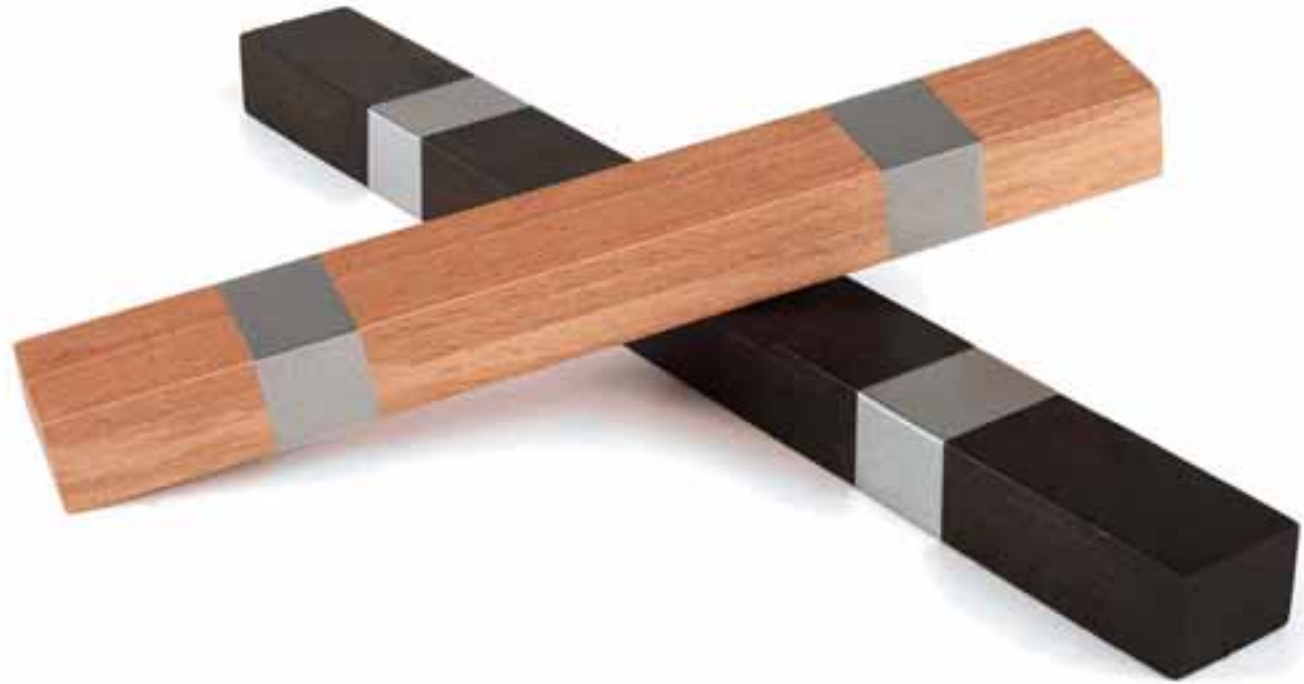
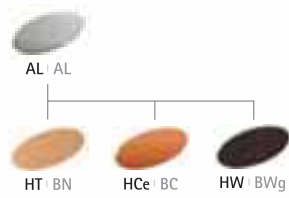

Diseños Designs Angel Alonso  
**Haya y metal**  
Beech & Metal

4 5

335.128  
335.160  
335.192

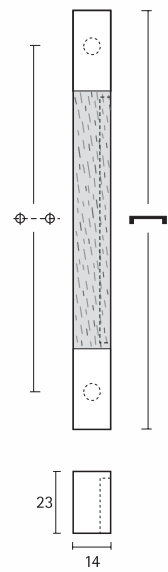

23 x 14 mm	23 mm
128	156
160	188
192	220

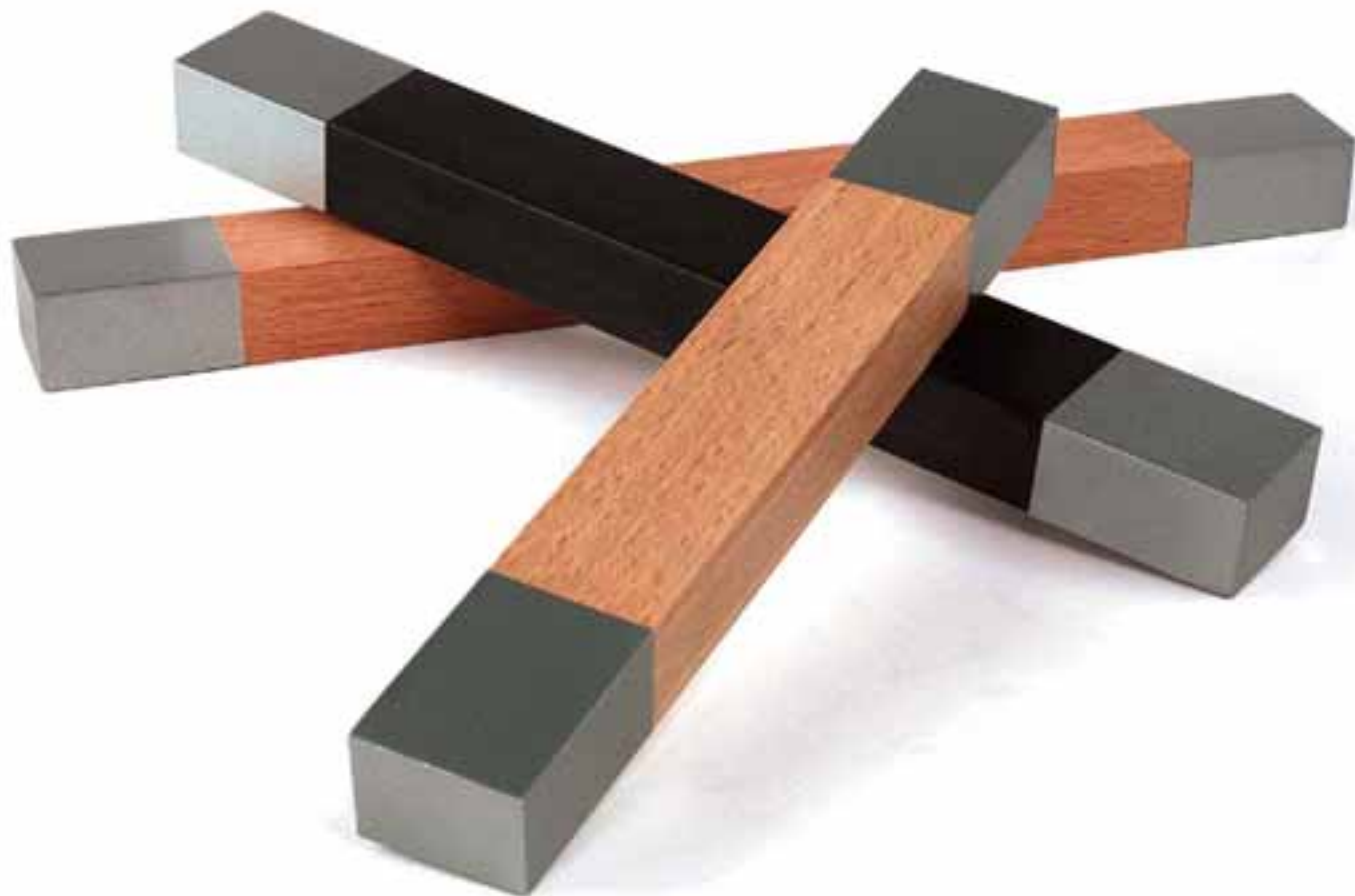
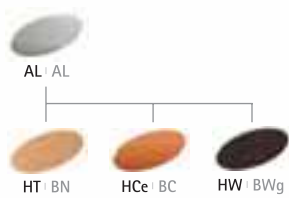

992-HA.160  
992-HA.192

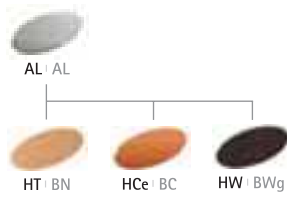
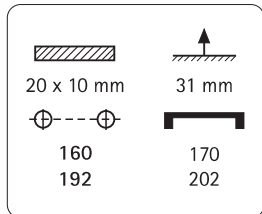
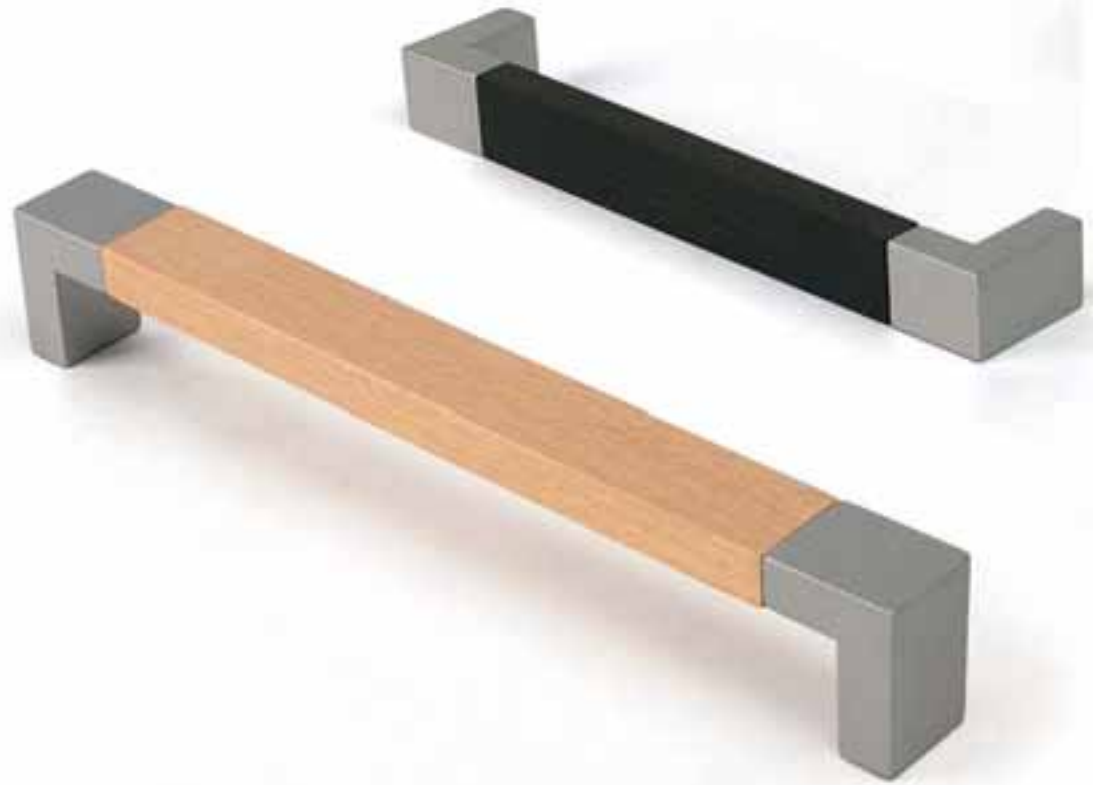
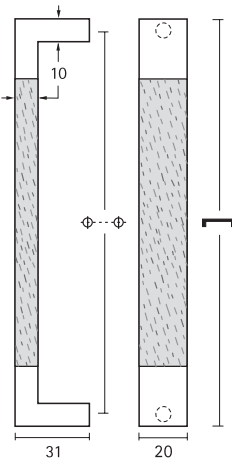

Haya y metal  
Beech & Metal

6 7

387

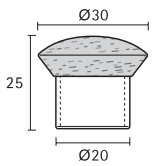

993-HA.160  
993-HA.192

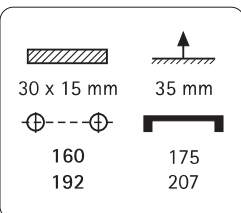
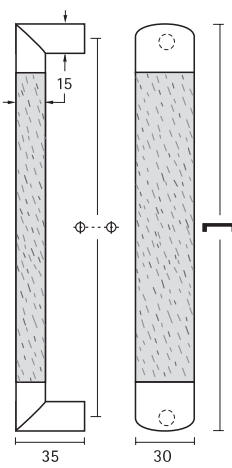



356

357

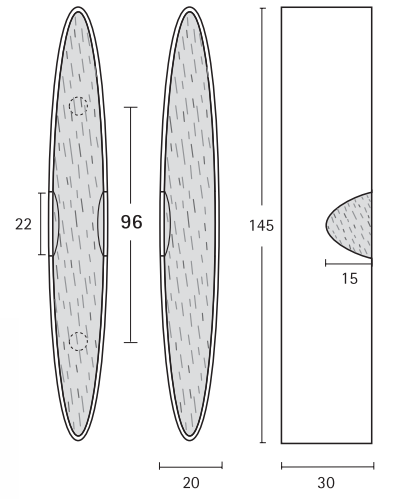

225

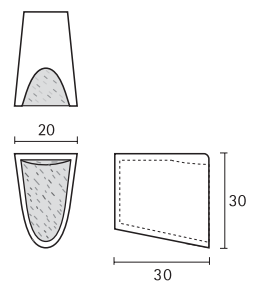

Diseños Designs Angel Alonso

**Haya y metal**  
Beech & Metal

8 9



223

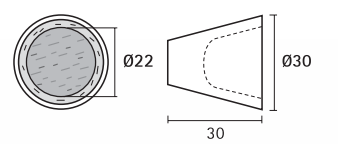

224

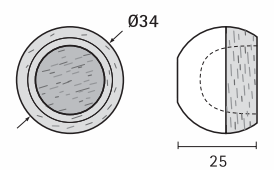

226

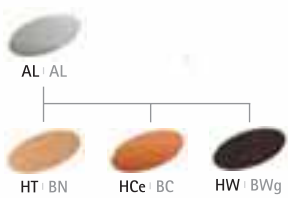
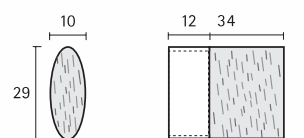

355

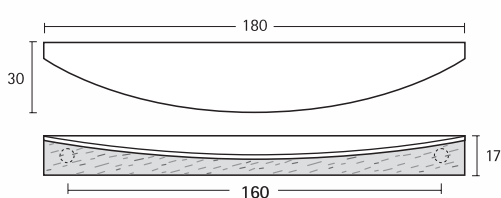



331

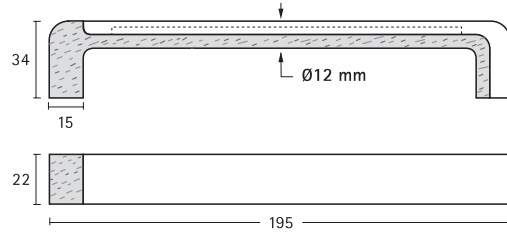

Diseños Designs Angel Alonso

**Haya y metal** 10 11  
Beech & Metal

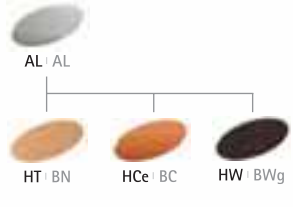

336.160  
336.192

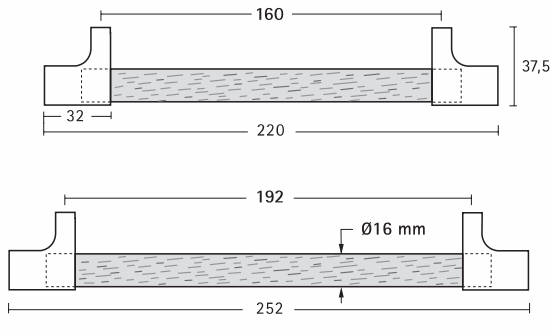

358

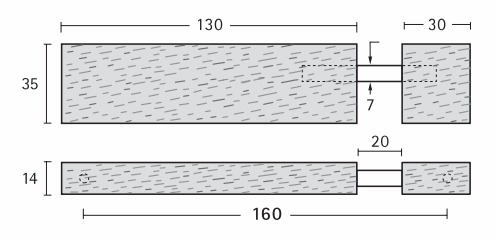

**Haya y metal**  
Beech & Metal

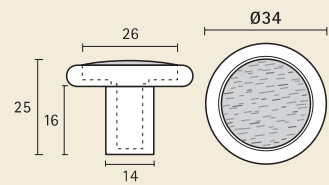
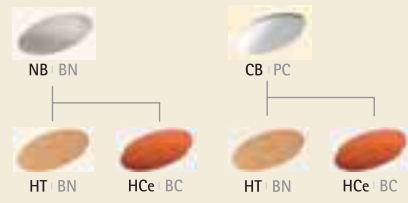

757

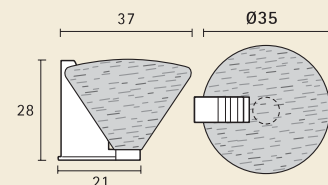

269

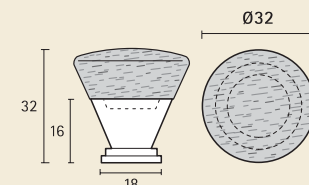

263

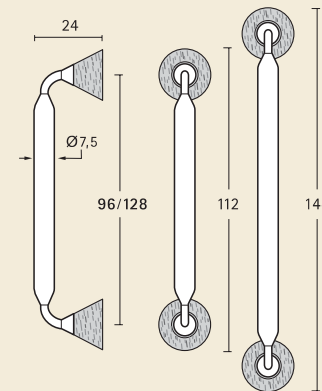

302/303

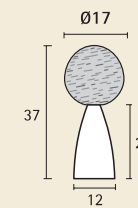

216

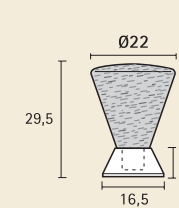

217

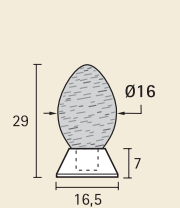

215



**Haya y metal**  
Beech & Metal

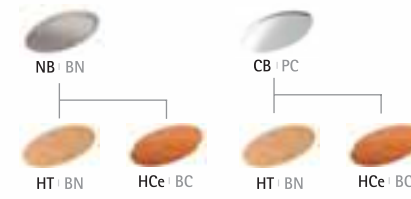

292

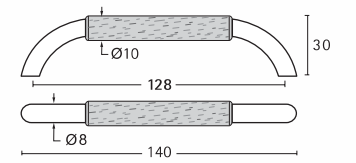

293.096  
293.128

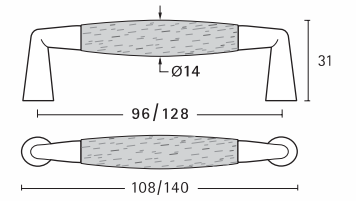

298

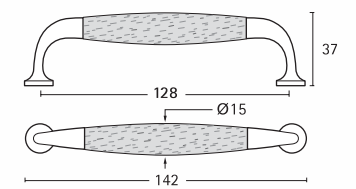

299

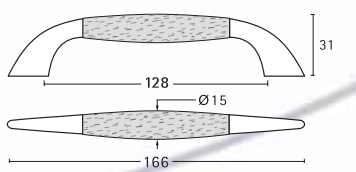



# Haya

Beech

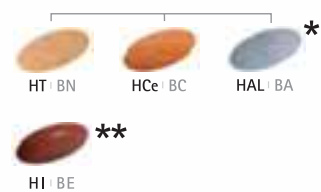

\* 380, 381, 386  
\*\* 385.25 | 385.35 | 385.47 | 385.53

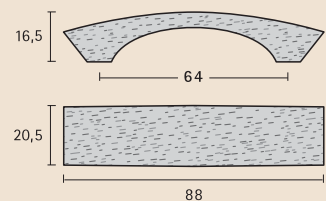

363

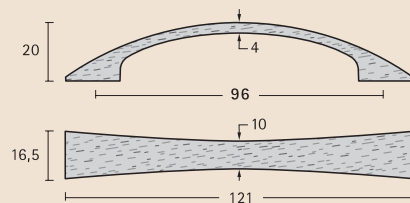

364

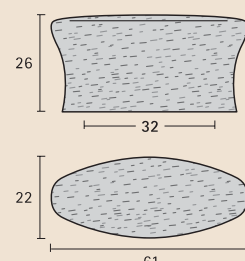

386

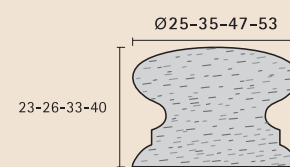

385

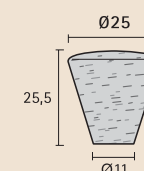

380

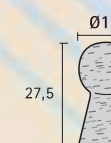

381

# Haya

Beech



\* 359, 382, 383, 384

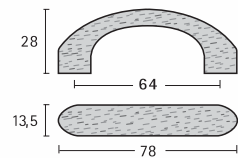

365.064

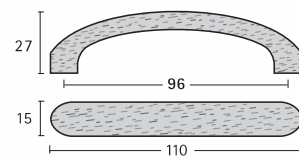

365.096

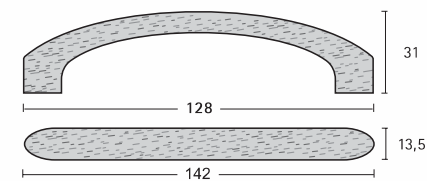

365.128

383

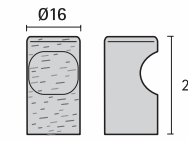

382

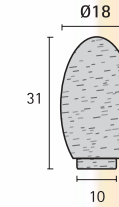

384

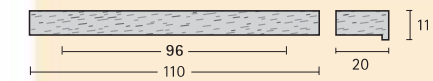
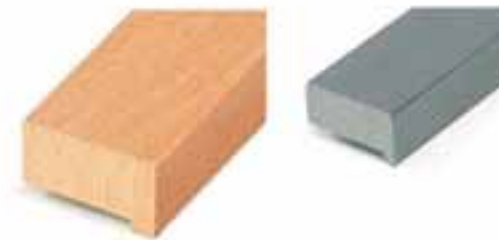
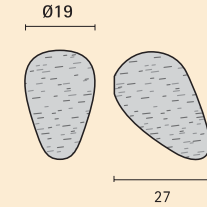

359

**Haya**  
Beech

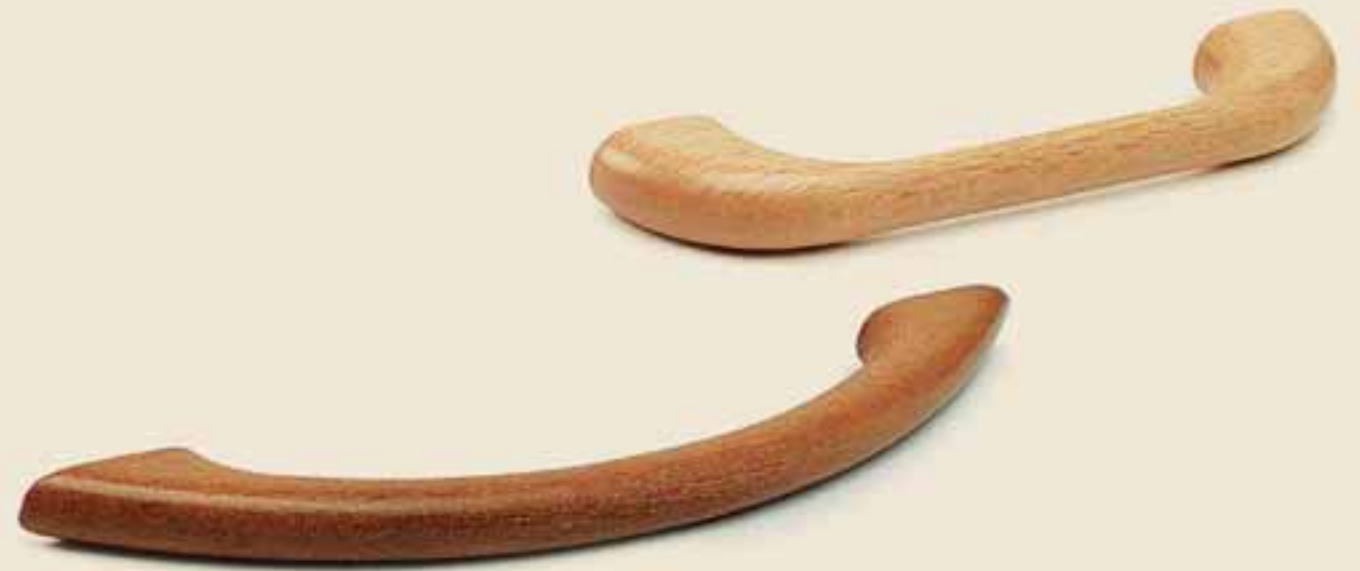
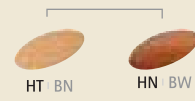

257

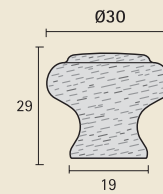

258-HA

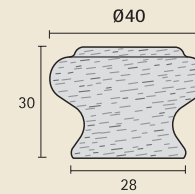

259

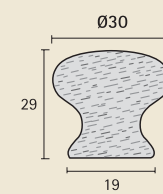

260

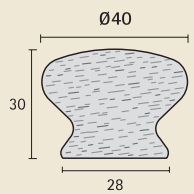

288-HA

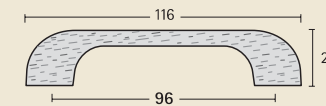

290-HA

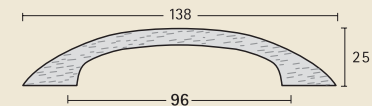

289-HA

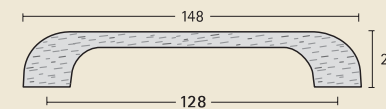

291-HA

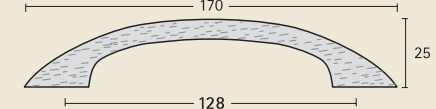

**Haya y Oro**  
Beech & Polished Gold

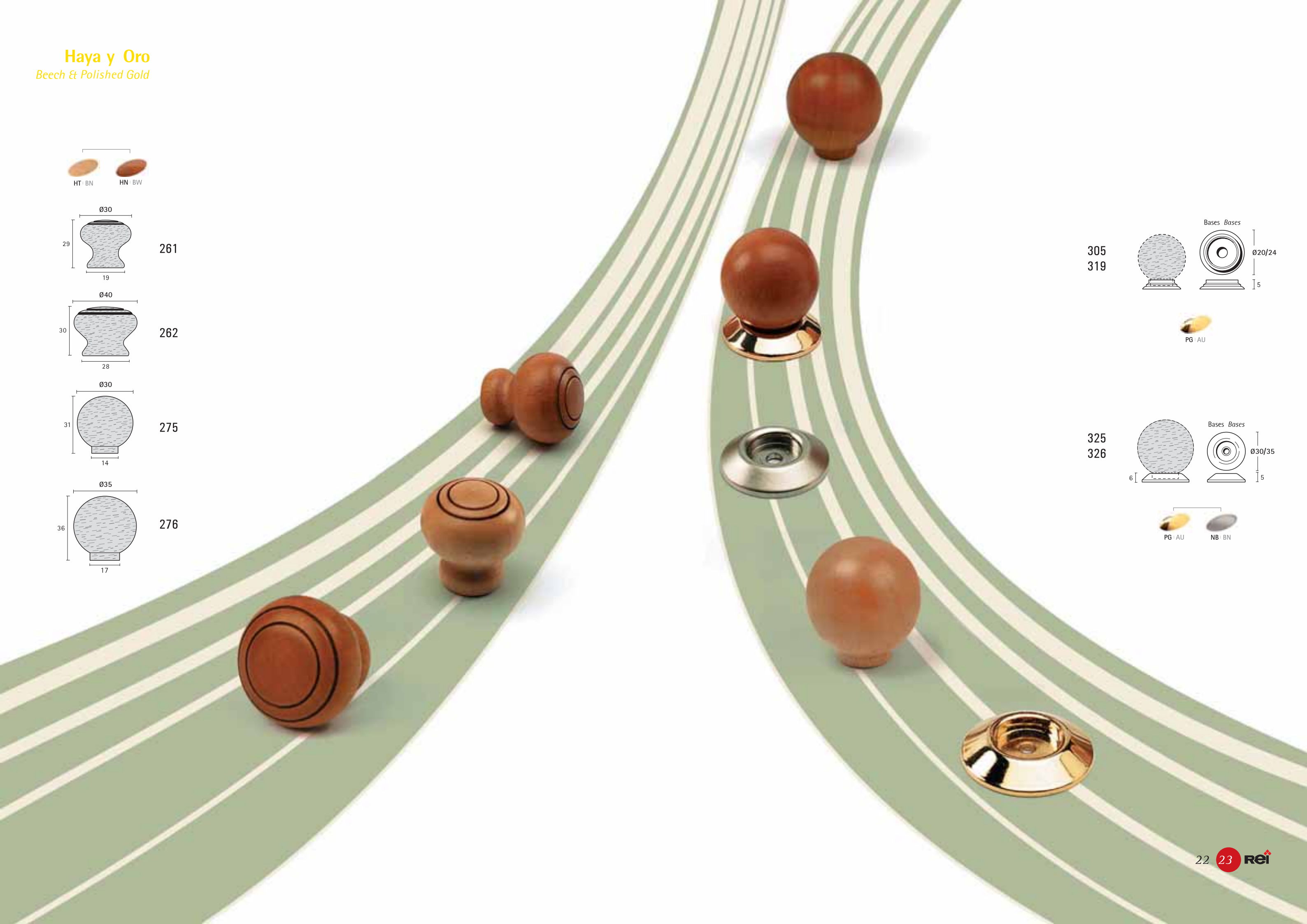
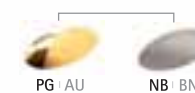
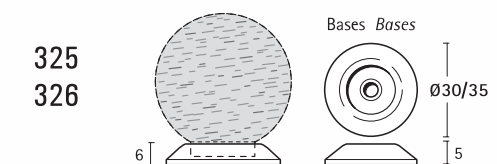
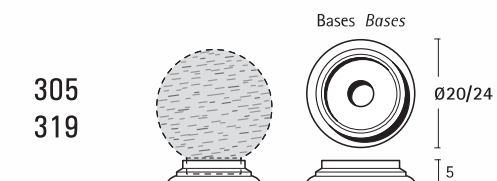
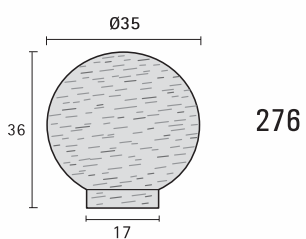
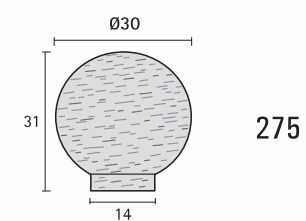
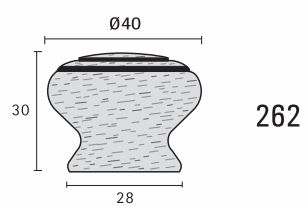
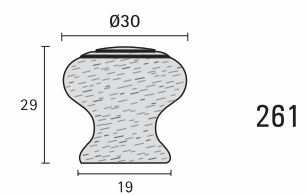

**Haya y Cuero | Oro**  
*Beech & Antique Brass | Gold*

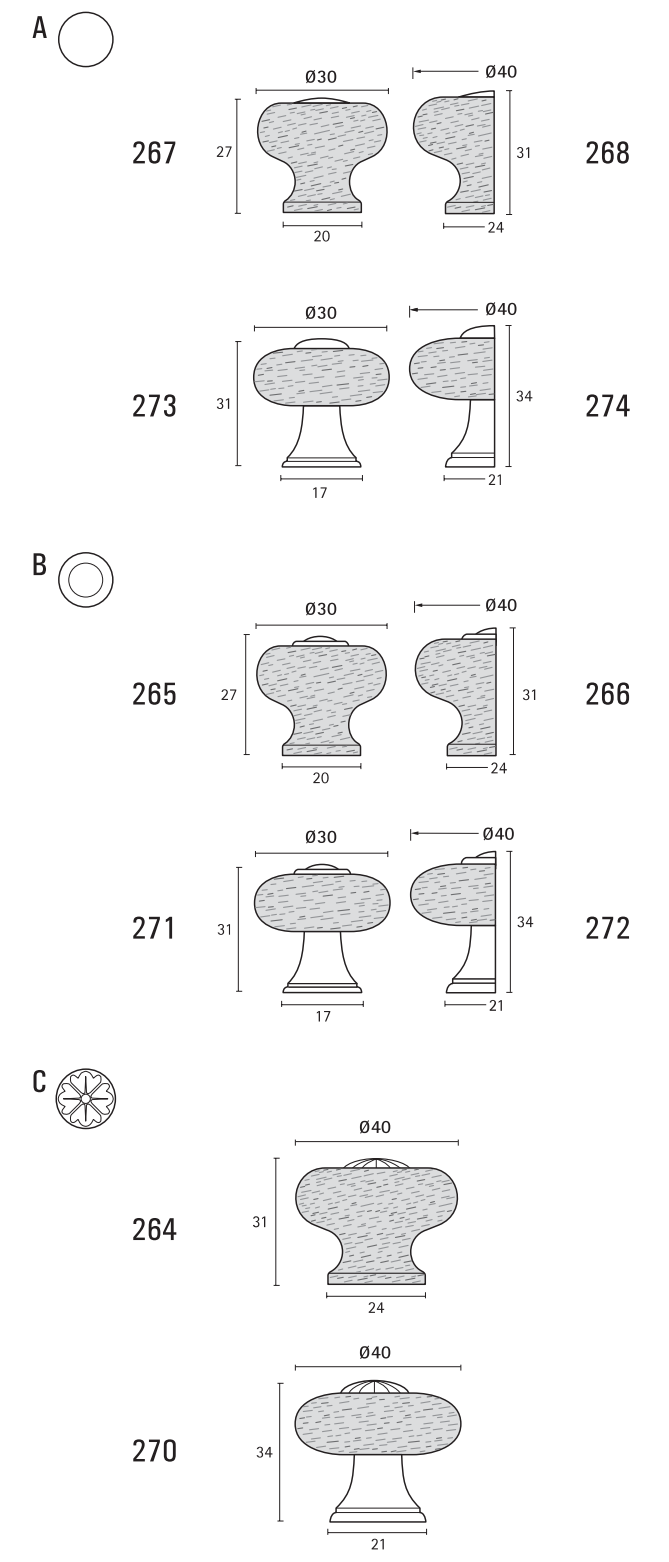
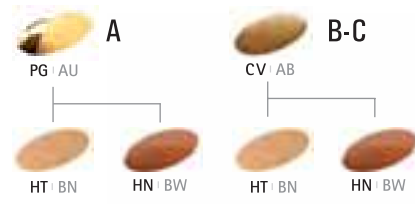

# Haya y Cuero | Oro

Beech & | Antique Brass  
Polished Gold



281

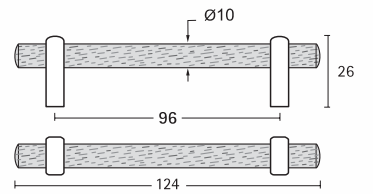

835-RO  
Roble-Oak

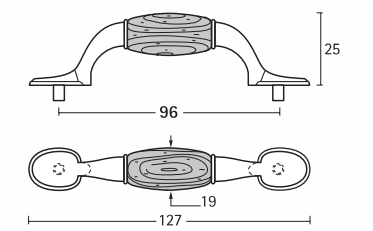

836-RO  
Roble-Oak

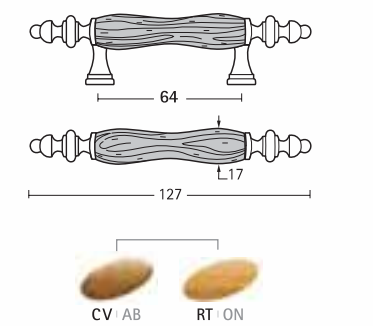

285

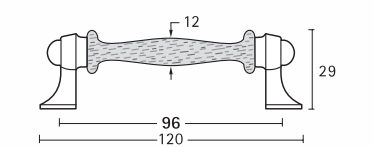

286

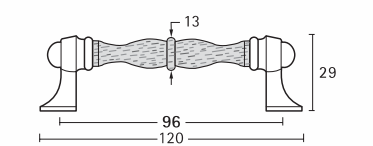

**Roble**  
*Oak*



288-RO 289-RO

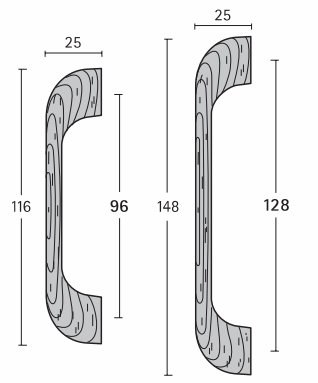

290-RO 291-RO

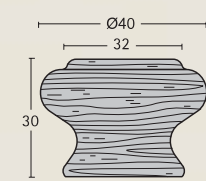
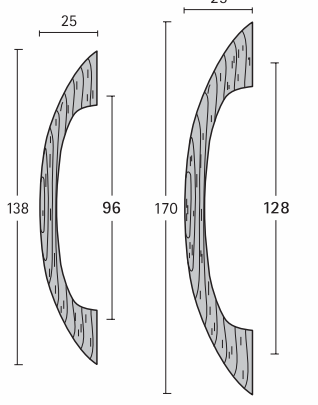

258-RO

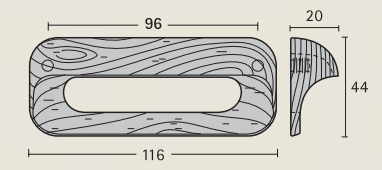

278

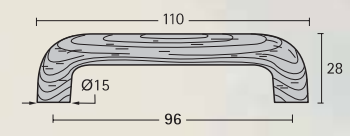

279

**Pino**  
Pine

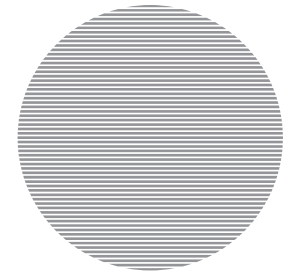
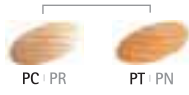

Todos los tiradores se suministran con tornillos metálicos M-4 para su montaje en el mueble.

Todos los componentes metálicos están fabricados en aleación de zinc y tienen rosca M-4 para su instalación.

Los tiradores de madera incorporan tuercas de latón M-4 embutidas para su anclaje duradero al mueble.

Todos los componentes de madera proceden de fuentes controladas y sostenibles con certificación FSC.

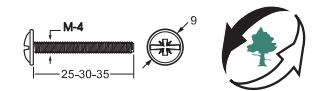

All fittings are supplied with M-4 metal screws for an easy installation on furniture.

All metal components are die-casted in zinc alloy and have M-4 threads for screwing.

All wooden knobs & handles have inserted M-4 brass nuts for a long lasting and resistant connection to furniture.

All wooden components come from controlled and sustainable forest sources with FSC certification.

248

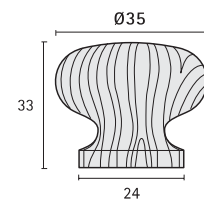

253

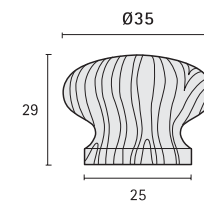

254

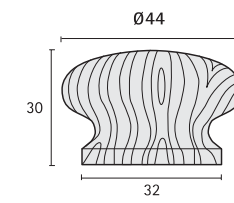

255

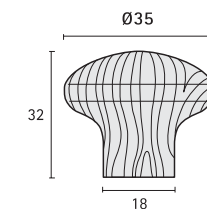

256

