



**BRONCES PRISMA**

 **LINEA ALABAU**

*B*ronces Prisma, s.l., es una empresa dedicada a la fabricación de artículos de latón, avalada por la amplia experiencia de su equipo humano en continua evolución e innovación.

Gracias a la utilización de las mejores materias primas, cuidado proceso de fabricación y al esmerado acabado de nuestros productos, sitúa a nuestra empresa, como referencia de calidad y diseño.

Motivados por un mercado cada vez más exigente, y sabedores de que la calidad es nuestra mejor publicidad, nuestro departamento de diseño, ofrece la posibilidad de personalizar el producto a las necesidades que nuestros clientes requieren.

Bronces Prisma, s.l., se complace en ofrecer su nuevo catálogo, siguiendo fiel a su concepto de imagen y diseño.

*B*ronces Prisma s.l. is a company engaged in making brass articles, vouched for by the wide experience of its human resources, in a constant development and innovation process.

The use of the best raw materials, painstaking manufacturing process and meticulous finish of our products have made our company a landmark in quality and design.

Spurred on by an increasingly demanding market and well aware that quality is our best advertisement, our design department offers the possibility to personalise the product to match our customers' requirements.

Bronces Prisma s.l. is pleased to offer you its new catalogue, faithful to its own concept of image and design.

*B*ronces Prisma s.l. est une entreprise specialisee dans la fabrication d'articles en laiton, garantie par la grande experience de son equipe de techniciens en constante evolution et innovation.

Grace a l'utilisation des meilleures mateires premieres, d'un processus de fabrication tres soigne ainse qu'une tres bonne finittion de nos produits, notres entreprise se classe en reference de qualite et design.

Conscients d'un marche chaque fois plus exigeant et sachant que la qualite est notre meilleure publicite, notre bureau au d'etude offre la possibilite de personnaliser le produit aux exigences de nos clients.

Bronces Prisma, s.l. a le plaisir de vous offrir son nouveau catalogue, restant fidele a son image de marque et a son design.

A partir des meilleures matieres premieres, et avec un processus de fabrication soigne, nous obtenons des produits de haute qualite.

*B*ronces Prisma GmbH, ist ein Unternehmen, welches sich der Herstellung von Messingartiklen widnet. Die Mitarbeiter verfügen über umfangreiche Erfahrungen und bürgen für einen fortlaufenden Entwicklungs- und Innovationsprozeß.

Allein durch die Verwendung von besten Rohstoffen, einem präzisen Fertigungsprozeß sowie der sorgsamem Vollendung unserer Produkte, positioniert sich unser Unternehmen zur ersten Adresse für Qualität und Design.

Wir sind von einem Markt stetig steigender Anforderungen motiviert und wissen, daß Qualität unsere beste Promotion ist. Bei der Fertigung unserer Produkte bietet unsere Designabteilung die Möglichkeit, die individuellen Bedürfnisse unserer Kunden zu berücksichtigen.

Bronces Prisma GmbH ist erfreut, ihnen ihren Katalog vorstellen zu können, welcher treu das Konzept der Firma in Bild and Design widerspiegelt.

Durch Verwendung erstklassiger Robstoffe und einem präzisen Fertigungsprozenß erhalten wir Produkte höchsten Anspruchs.

*P*artiendo de las mejores  
materias primas,  
y con un cuidado  
proceso de fabricación...

...obtenemos  
productos de  
*alta calidad.*



Modelo / Model 6033 sstras



6033 OG



© MARCAS Y MODELOS REGISTRADOS

© REGISTERED TRADE MARK AND MODELS



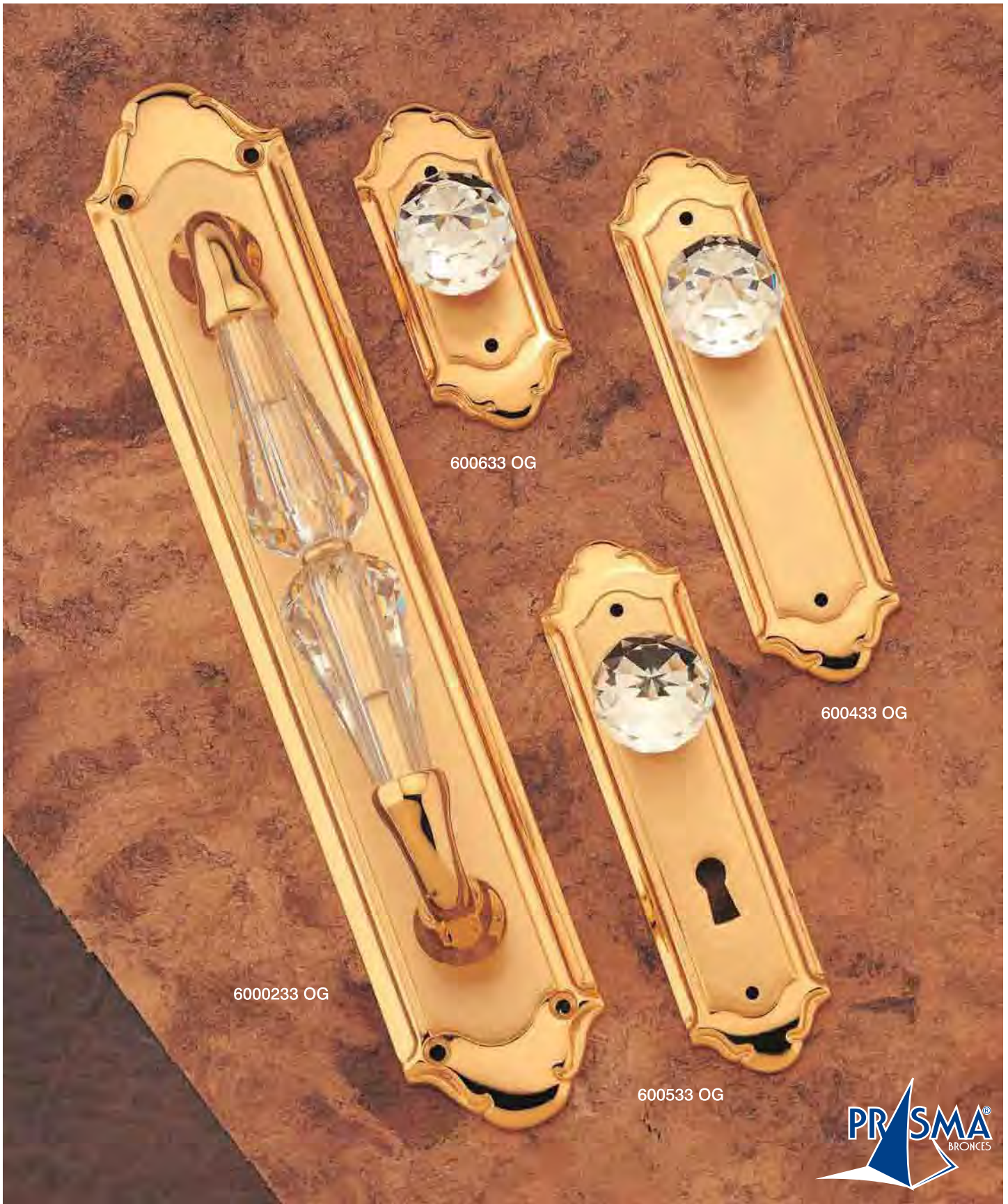

**MODELO 6033 sstras DESCRIPCIÓN / DESCRIPTION**

			<b>MEDIDA / SIZE</b>
01	Juego manivelas	/ Set handles .....	274 x 53 mm.
02	Asa fija (manillón)	/ Fixed handle .....	274 x 53 mm.
03	Placa limpieza	/ Smear plate .....	274 x 53 mm.
04	Pomo armario s/b	/ s/b Cupboard handle.....	139 x 38 mm.
05	Pomo armario c/b	/ c/b Cupboard handle.....	139 x 38 mm.
06	Pomo maletero	/ Large handle .....	85 x 38 mm.
07	Placa c/pomo giratorio	/ Plate with revolving .....	274 x 53 mm.
08	Manivela grisan	/ "Grisan" handle .....	139 x 38 mm.
209/B	Pomo muletilla standar	/ Standar key .....	□ 6 mm.

**ACABADOS:**  
 Baño oro, oro niquel, oro lijado,  
 oro rodio, oro grafilado,  
 oro niquel grafilado.

**FINISH:**  
 Gold finger, nickel gold,  
 sanded gold, rhodium gold,  
 dulled gold, nickel gold dulled.

© MARCAS Y MODELOS REGISTRADOS

© REGISTERED TRADE MARK AND MODELS

Modelo / Model 6033 sstras

Modelo / Model 533 sstras



6033 RA

533 RO

**MODELO / MODEL**    **MEDIDA / SIZE**

6033 sstras

274 x 53 mm.

533 sstras

50 mm.

© MARCAS Y MODELOS REGISTRADOS

© REGISTERED TRADE MARK AND MODELS

Modelo / *Model 6020*

Modelo / *Model 6033*



6020 RA

6033 RO

**ACABADOS / FINISH**

OR	Oro	/	Gold
OGF	Oro grafilado	/	Gold dulled
RA	Nogal oro	/	Walnut gold
RO	Oro rodio	/	Gold rhodium

© MARCAS Y MODELOS REGISTRADOS

© REGISTERED TRADE MARK AND MODELS



Modelo / Model 7080



7080

© MARCAS Y MODELOS REGISTRADOS

© REGISTERED TRADE MARK AND MODELS



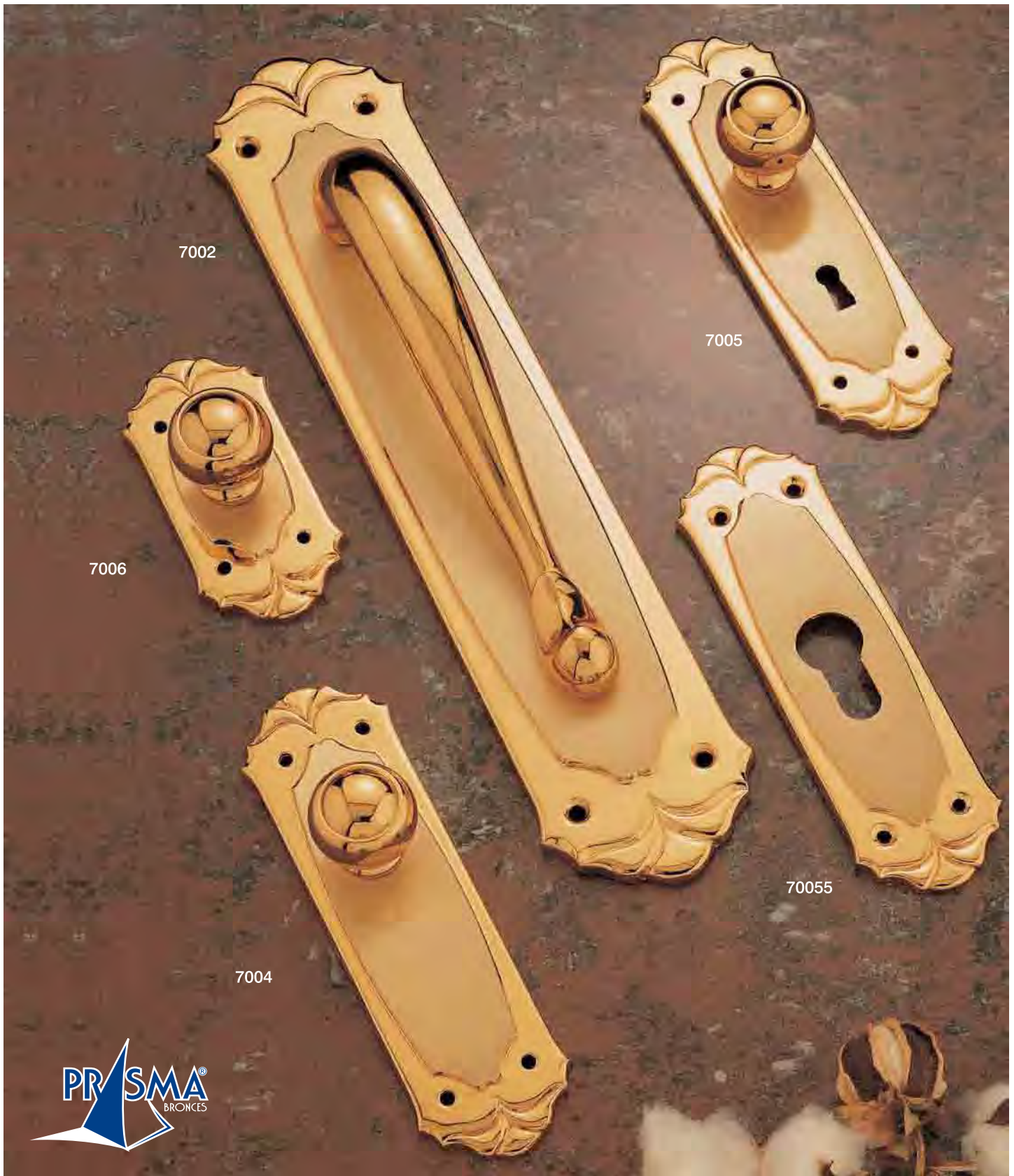

**MODELO 7080**

**DESCRIPCIÓN / DESCRIPTION**

**MEDIDA / SIZE**

01	Juego manivelas	/ Set handles .....	281 x 57 mm.
02	Asa fija (manillón)	/ Fixed handle.....	281 x 57 mm.
03	Placa limpieza	/ Smear plate.....	281 x 57 mm.
04	Pomo armario s/b	/ s/b Cupboard handle.....	143 x 40 mm.
05	Pomo armario c/b	/ c/b Cupboard handle.....	143 x 40 mm.
06	Pomo maletero	/ Large handle .....	87 x 40 mm.
07	Placa c/pomo giratorio	/ Plate with revolving .....	281 x 57 mm.
08	Manivela grisan	/ "Grisan" handle .....	143 x 40 mm.

© MARCAS Y MODELOS REGISTRADOS

© REGISTERED TRADE MARK AND MODELS

**ACABADOS:**

Brillo mate, cuero satinado, baño oro, oro niquel, oro lijado, oro rodio, oro grafilado, oro niquel grafilado, bronce inglés, cromo, acero.

**FINISH:**

Dull shine, satin leather, gold finger, nickel gold, sanded gold, rhodium gold, dulled gold, nickel gold dulled, english bronze, chrome, steel.

Modelo / Model 6020

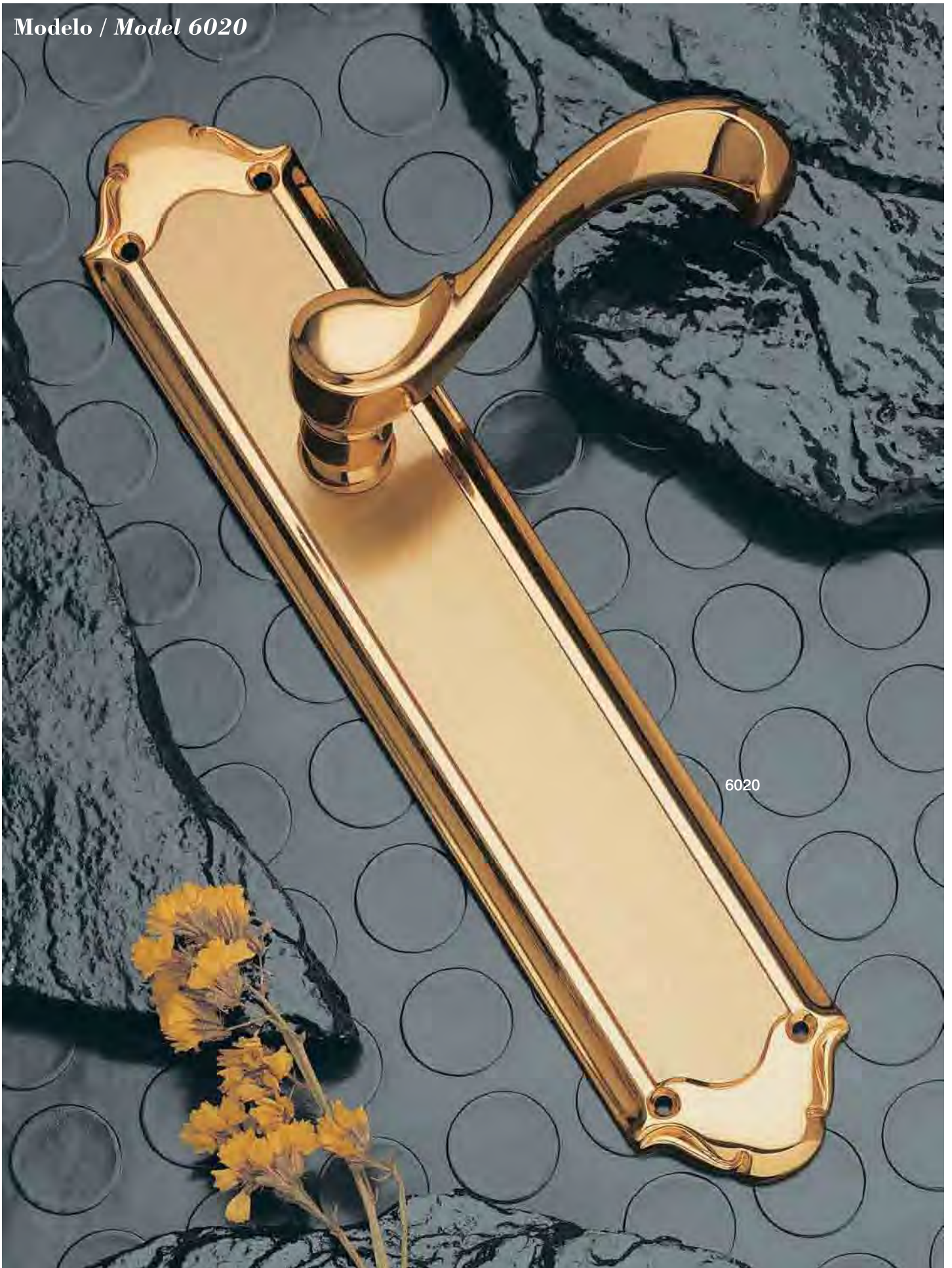

6020

© MARCAS Y MODELOS REGISTRADOS

© REGISTERED TRADE MARK AND MODELS





**MODELO 6020**

**DESCRIPCIÓN / DESCRIPTION**

**MEDIDA / SIZE**

01	Juego manivelas	/ Set handles .....	274 x 53 mm.
02	Asa fija (manillón)	/ Fixed handle .....	274 x 53 mm.
03	Placa limpieza	/ Smear plate .....	274 x 53 mm.
04	Pomo armario s/b	/ s/b Cupboard handle .....	139 x 38 mm.
05	Pomo armario c/b	/ c/b Cupboard handle .....	139 x 38 mm.
06	Pomo maletero	/ Large handle .....	85 x 38 mm.
07	Placa c/pomo giratorio	/ Plate with revolving .....	274 x 53 mm.
08	Manivela grisan	/ "Grisan" handle .....	139 x 38 mm.
501/A	Pomo centro puerta	/ Central door knob .....	Ø 85 mm.
209/B	Pomo muletilla standar	/ Standar key .....	□ 6 mm.

© MARCAS Y MODELOS REGISTRADOS

© REGISTERED TRADE MARK AND MODELS

**ACABADOS:**

Brillo mate, cuero satinado, baño oro, oro niquel, oro lijado, oro rodio, oro grafilado, oro niquel grafilado, bronce inglés, cromo, acero.

**FINISH:**

Dull shine, satin leather, gold finger, nickel gold, sanded gold, rhodium gold, dulled gold, nickel gold dulled, english bronze, chrome, steel.

Modelo / Model 5010



5010

© MARCAS Y MODELOS REGISTRADOS

© REGISTERED TRADE MARK AND MODELS





**MODELO 5010**

**DESCRIPCIÓN / DESCRIPTION**

**MEDIDA / SIZE**

01	Juego manivelas	/ Set handles .....	268 x 47 mm.
02	Asa fija (manillón)	/ Fixed handle .....	268 x 47 mm.
03	Placa limpieza	/ Smear plate .....	268 x 47 mm.
04	Pomo armario s/b	/ s/b Cupboard handle .....	129 x 32 mm.
05	Pomo armario c/b	/ c/b Cupboard handle .....	129 x 32 mm.
06	Pomo maletero	/ Large handle .....	80 x 32 mm.
07	Placa c/pomo giratorio	/ Plate with revolving .....	268 x 47 mm.
08	Manivela grisan	/ "Grisan" handle .....	129 x 32 mm.
501/A	Pomo centro puerta	/ Central door knob .....	Ø 85 mm.
209/B	Pomo muletilla standar	/ Standar key .....	□ 6 mm.

© MARCAS Y MODELOS REGISTRADOS

© REGISTERED TRADE MARK AND MODELS

**ACABADOS:**

Brillo mate, cuero satinado, baño oro, oro niquel, oro lijado, oro rodio, oro grafilado, oro niquel grafilado, bronce inglés, cromo, acero.

**FINISH:**

Dull shine, satin leather, gold finger, nickel gold, sanded gold, rhodium gold, dulled gold, nickel dulled, english bronze, chrome, steel.

Modelo / Model 5010  
 Modelo / Model 5007



5010

5007

**ACABADOS / FINISH**

BIN	Bronce inglés	/	English bronze
OGF	Oro grafilado	/	Gold dulled
CUS	Cuero satinado	/	Satin leather
RO	Oro rodio	/	Gold rhodium
CR	Cromo	/	Chrome

**MODELO / MODEL**

5010
5007

**MEDIDA / SIZE**

268 x 47 mm.
268 x 47 mm.

© MARCAS Y MODELOS REGISTRADOS

© REGISTERED TRADE MARK AND MODELS





**ACABADOS / FINISH**

BIN	Bronce inglés	/	English bronze
OGF	Oro grafilado	/	Gold dulled
CUS	Cuero satinado	/	Satin leather
RO	Oro rodio	/	Gold rhodium
CR	Cromo	/	Chrome

**Modelo / Model 3010**  
**Modelo / Model 4011**

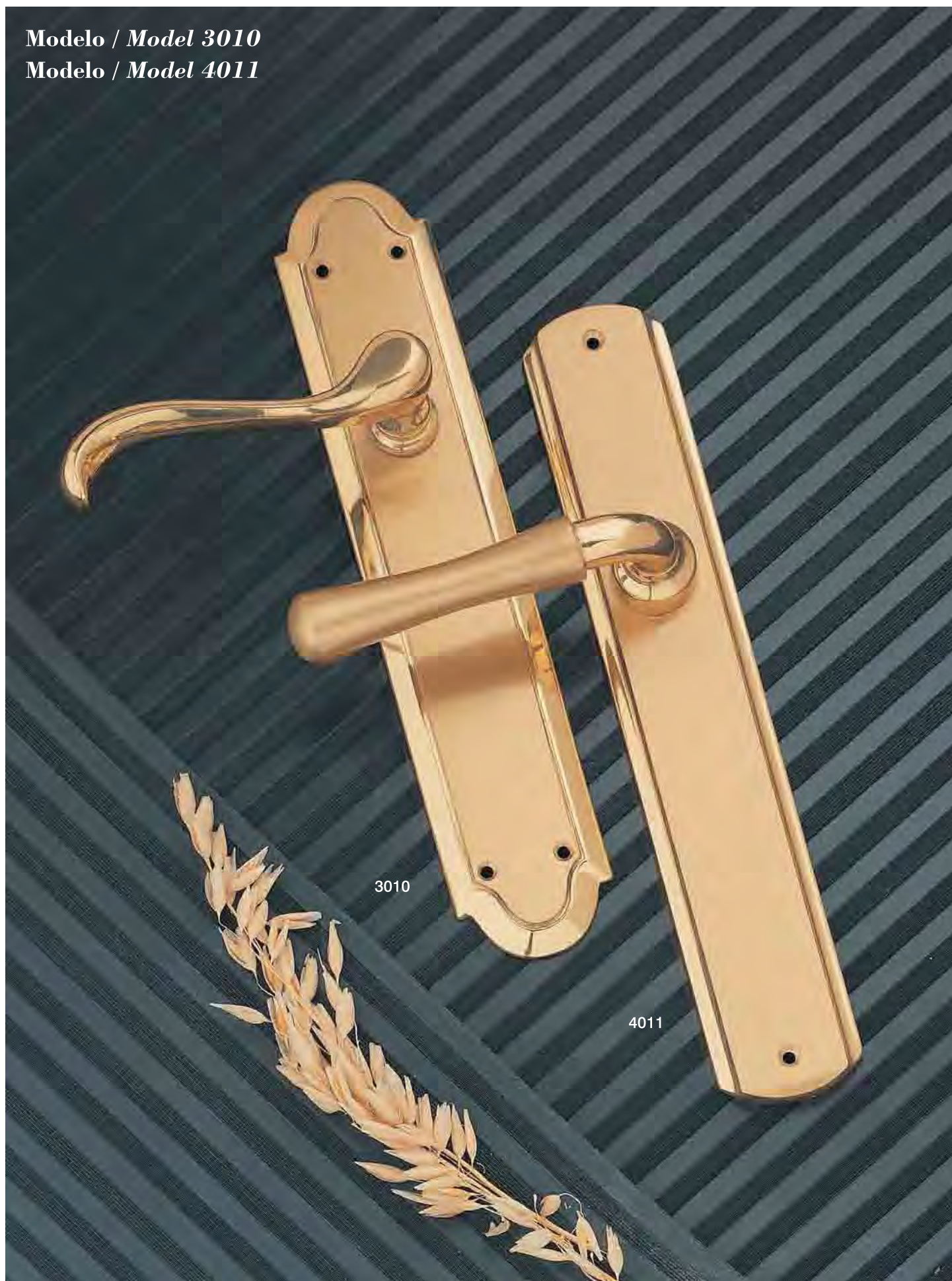

**ACABADOS / FINISH**

BIN	Bronce inglés	/	English bronze
OGF	Oro grafilado	/	Gold dulled
CUS	Cuero satinado	/	Satin leather
RO	Oro rodio	/	Gold rhodium
CR	Cromo	/	Chrome

**MODELO / MODEL**

3010
4011

**MEDIDA / SIZE**

257 x 50 mm.
258 x 46 mm.

© MARCAS Y MODELOS REGISTRADOS

© REGISTERED TRADE MARK AND MODELS





Modelo / Model 3002  
 Modelo / Model 3004  
 Modelo / Model 3005  
 Modelo / Model 3006



3005

3004

3006

3002

**ACABADOS / FINISH**

BIN Bronce inglés / English bronze  
 OR Oro / Gold  
 CUS Cuero satinado / Satin leather

ACE Acero / Steel  
 BM Brillo mate / Dull shine

Modelo / Model 2918



**ACABADOS / FINISH**

PB	Pulido Brillo	/	Polished shine	CR	Cromo	/	Chrome
OR	Oro	/	Gold	CRM	Cromo Mate	/	Matt Chrome
LM	Latón Mate	/	Matt brass	ACE	Acero	/	Steel
LAN	Latón Antiguo	/	Old brass	BIN	Bronce Inglés	/	English bronze



Modelo / Model 6180

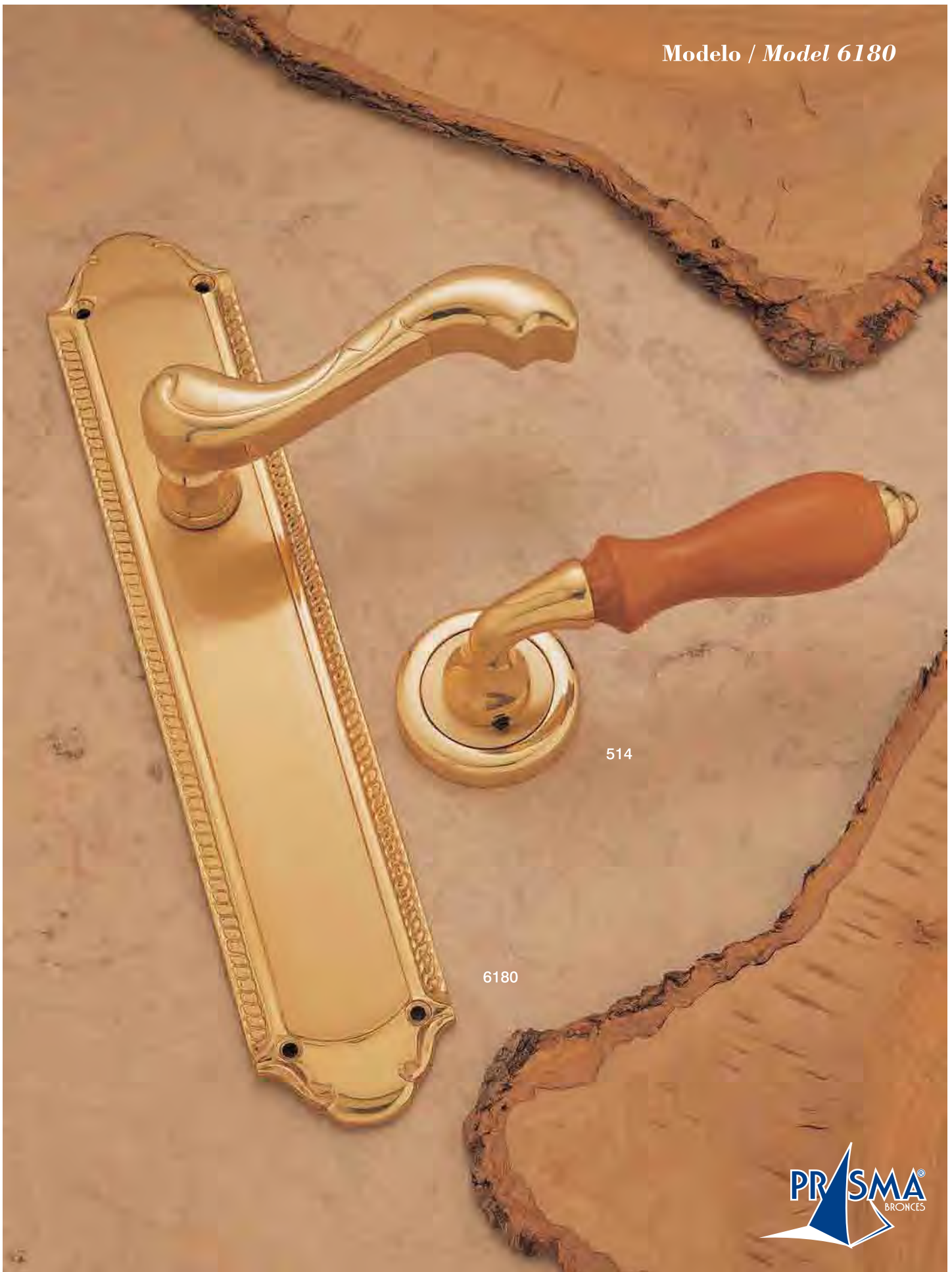

6180

514



**ACABADOS / FINISH**

CUS	Cuero satinado /	Satin leather
BM	Brillo mate /	Dull shine
BO	Baño oro /	Gold finger
ON	Oro niquel /	Nickel gold
OL	Oro lijado /	Sanded gold
OR	Oro rodio /	Rhodium gold

**ACABADOS / FINISH**

OG	Oro grafilado /	Dulled gold
ORG	Oro niquel gradilado /	Nickel gold dulled
BR	Bronce inglés /	English bronze
CR	Cromo /	Chrome
ACE	Acero /	Steel

**MODELO / MODEL**  
6180

**MEDIDA / SIZE**  
274 x 53 mm.

© MARCAS Y MODELOS REGISTRADOS  
© REGISTERED TRADE MARK AND MODELS

Modelo / Model 5111

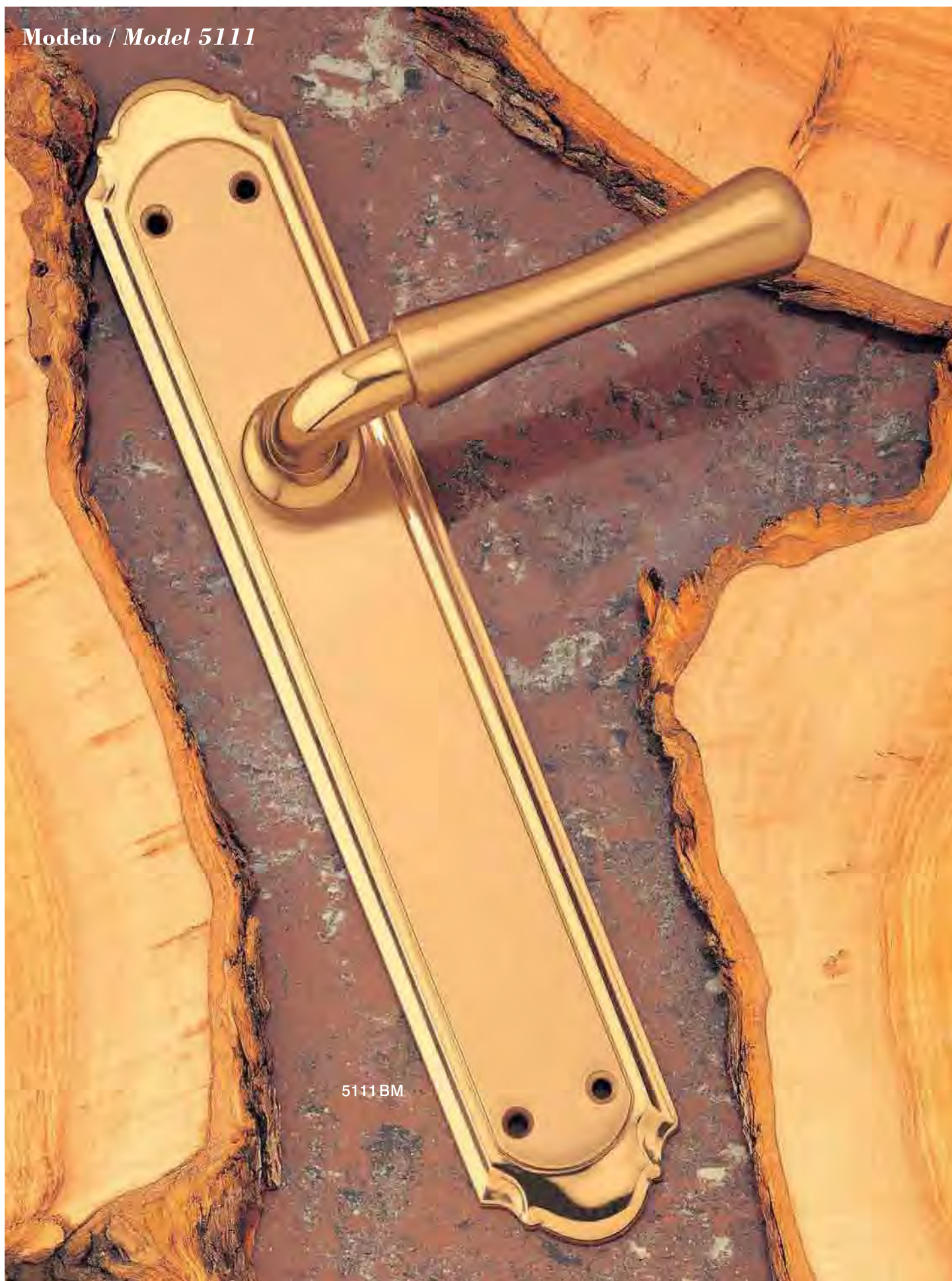

5111 BM

**ACABADOS / FINISH**

BIN	Bronce inglés	/	English bronze
OGF	Oro grafilado	/	Gold dulled
CUS	Cuero satinado	/	Satin leather
RO	Oro rodio	/	Gold rhodium
CR	Cromo	/	Chrome

**MODELO / MODEL**

5111

**MEDIDA / SIZE**

268 x 47 mm.

© MARCAS Y MODELOS REGISTRADOS

© REGISTERED TRADE MARK AND MODELS



Modelo / Model 2010



2010 OL

**ACABADOS / FINISH**

BIN	Bronce inglés	/	English bronze
OGF	Oro grafilado	/	Gold dulled
CUS	Cuero satinado	/	Satin leather
RO	Oro rodio	/	Gold rhodium
CR	Cromo	/	Chrome

**MODELO / MODEL**  
2010

**MEDIDA / SIZE**  
268 x 47,5 mm.

© MARCAS Y MODELOS REGISTRADOS

© REGISTERED TRADE MARK AND MODELS



**Modelo / Model 4030**  
**Modelo / Model 1030**  
**Modelo / Model 209 MB**

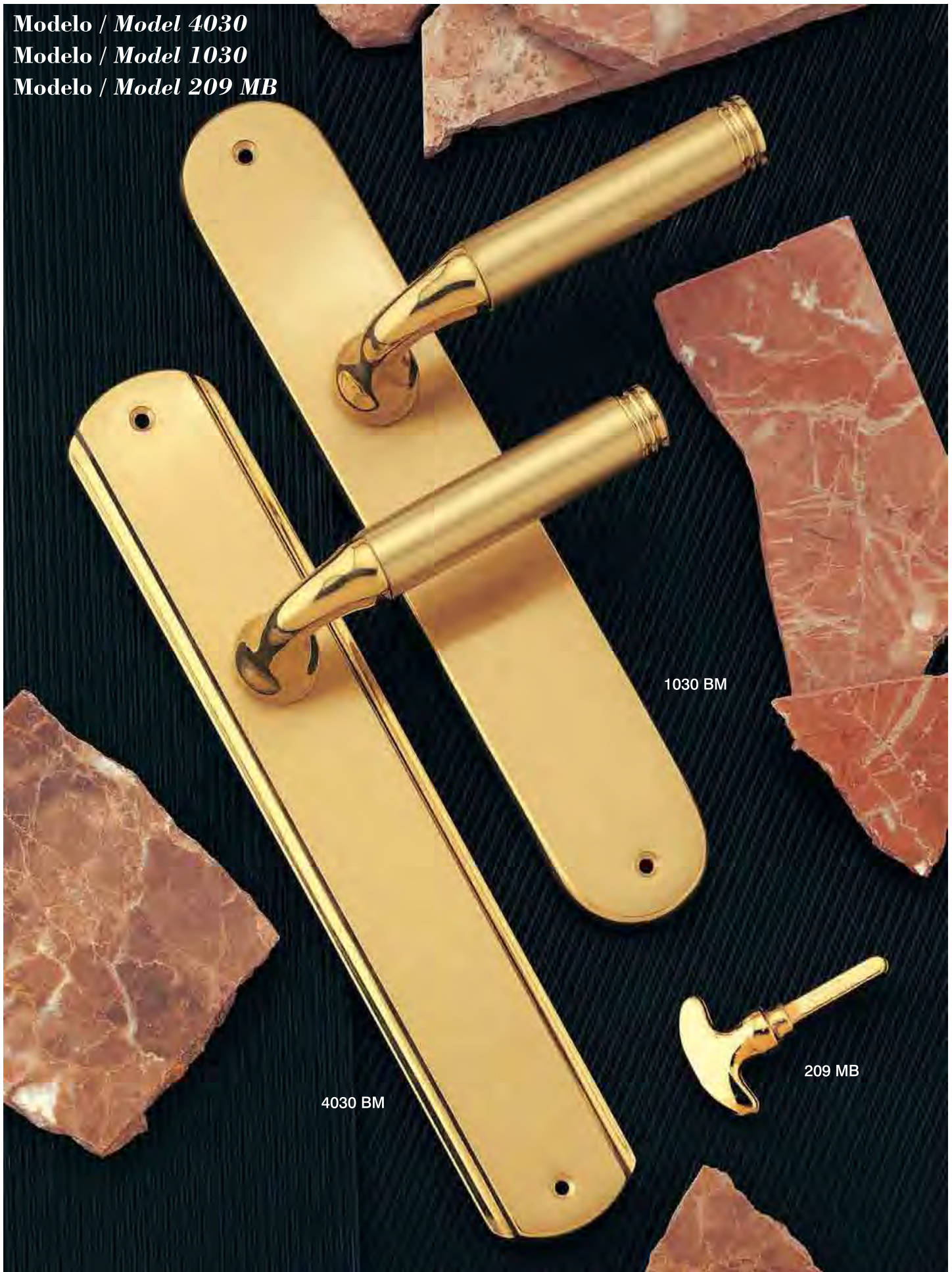

4030 BM

1030 BM

209 MB

**ACABADOS / FINISH**

BIN    Bronce inglés    /    *English bronze*  
 CUS    Cuero satinado    /    *Satin leather*  
 CR    Cromo    /    *Chrome*

**MODELO / MODEL**

4030  
 1030

**MEDIDA / SIZE**

258 x 46 mm.  
 246 x 46 mm.

Modelo / Model 1025 A  
Modelo / Model 1025 A

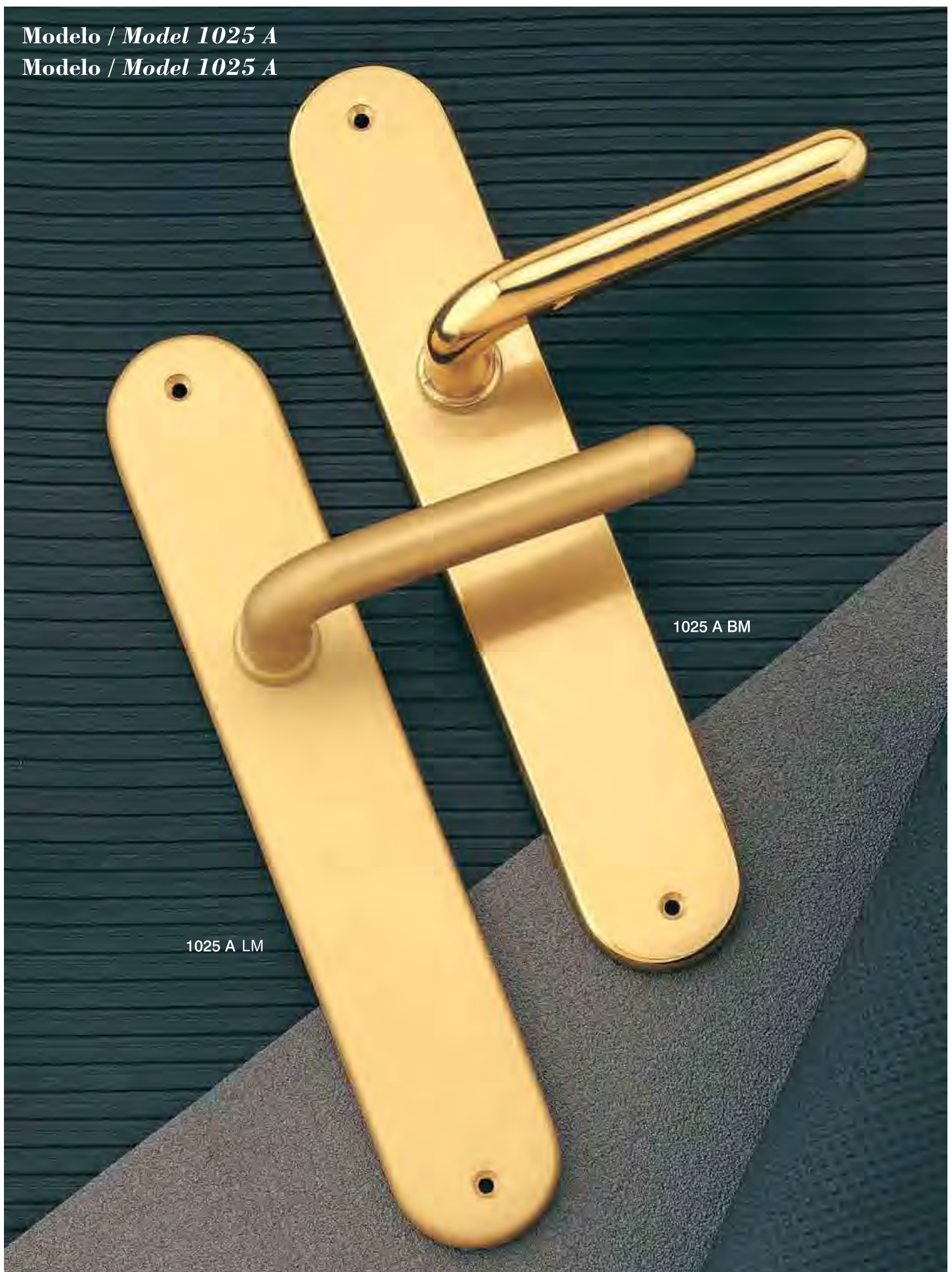

**ACABADOS / FINISH**

BIN	Bronce inglés	/	English bronze
CUS	Cuero satinado	/	Satin leather
CR	Cromo	/	Chrome
SAT	Satinado	/	Satin

**MODELO / MODEL**  
1025-A

**MEDIDA / SIZE**  
246 x 45 mm.

Modelo / Model 1025 A  
Modelo / Model 1025 B



1025 A ACE

1025 B ACE

© MARCAS Y MODELOS REGISTRADOS © REGISTERED TRADE MARK AND MODELS





1006 ACE

1002 ACE

1004 ACE

1008 ACE

MODELO	DESCRIPCIÓN / DESCRIPTION	MEDIDA / SIZE
01	Juego manivelas / Set handles	.....268 x 47 mm.
02	Asa fija (manillón) / Fixed handle	.....268 x 47 mm.
03	Placa limpieza / Smear plate	.....268 x 47 mm.
04	Pomo armario s/b / s/b Cupboard handle	.....127 x 33 mm.
05	Pomo armario c/b / c/b Cupboard handle	.....127 x 33 mm.
06	Pomo maletero / Large handle	.....80 x 33 mm.
07	Placa c/pomo giratorio / Plate with revolving	.....268 x 47 mm.
08	Manivela grisan / "Grisan" handle	.....174 x 33 mm.
990	Pomo centro puerta / Central door knob	..... Ø 90 mm.

© MARCAS Y MODELOS REGISTRADOS

© REGISTERED TRADE MARK AND MODELS

**ACABADOS:**

Brillo mate, cuero satinado, baño oro, oro lijado, bronce inglés, cromo, acero.

**FINISH:**

Dull shine, satin leather, gold finger, sanded gold, english bronze, chrome, steel.

Modelo / Model 4011  
 Modelo / Model 4025 B



4011 ACE

4025 B ACE

**ACABADOS / FINISH**

BIN	Bronce inglés	/	English bronze
ON	Oro níquel	/	Nickel gold
CUS	Cuero satinado	/	Satin leather
RO	Oro rodio	/	Gold rhodium
CR	Cromo	/	Chrome

**MODELO / MODEL**

4011
4025-B

**MEDIDA / SIZE**

258 x 46 mm.
258 x 46 mm.

© MARCAS Y MODELOS REGISTRADOS

© REGISTERED TRADE MARK AND MODELS



**Modelo / Model 3509**  
**Modelo / Model 3409**



3509 BM

3409 BM

**ACABADOS / FINISH**

BIN Bronce inglés / *English bronze*  
CUS Cuero satinado / *Satin leather*  
OR Oro / *Gold*

**MODELO / MODEL**

3509  
3409

**MEDIDA / SIZE**

256 x 46 mm.  
242 x 47 mm.

Modelo / Model 5517



5517 OL

© MARCAS Y MODELOS REGISTRADOS

© REGISTERED TRADE MARK AND MODELS

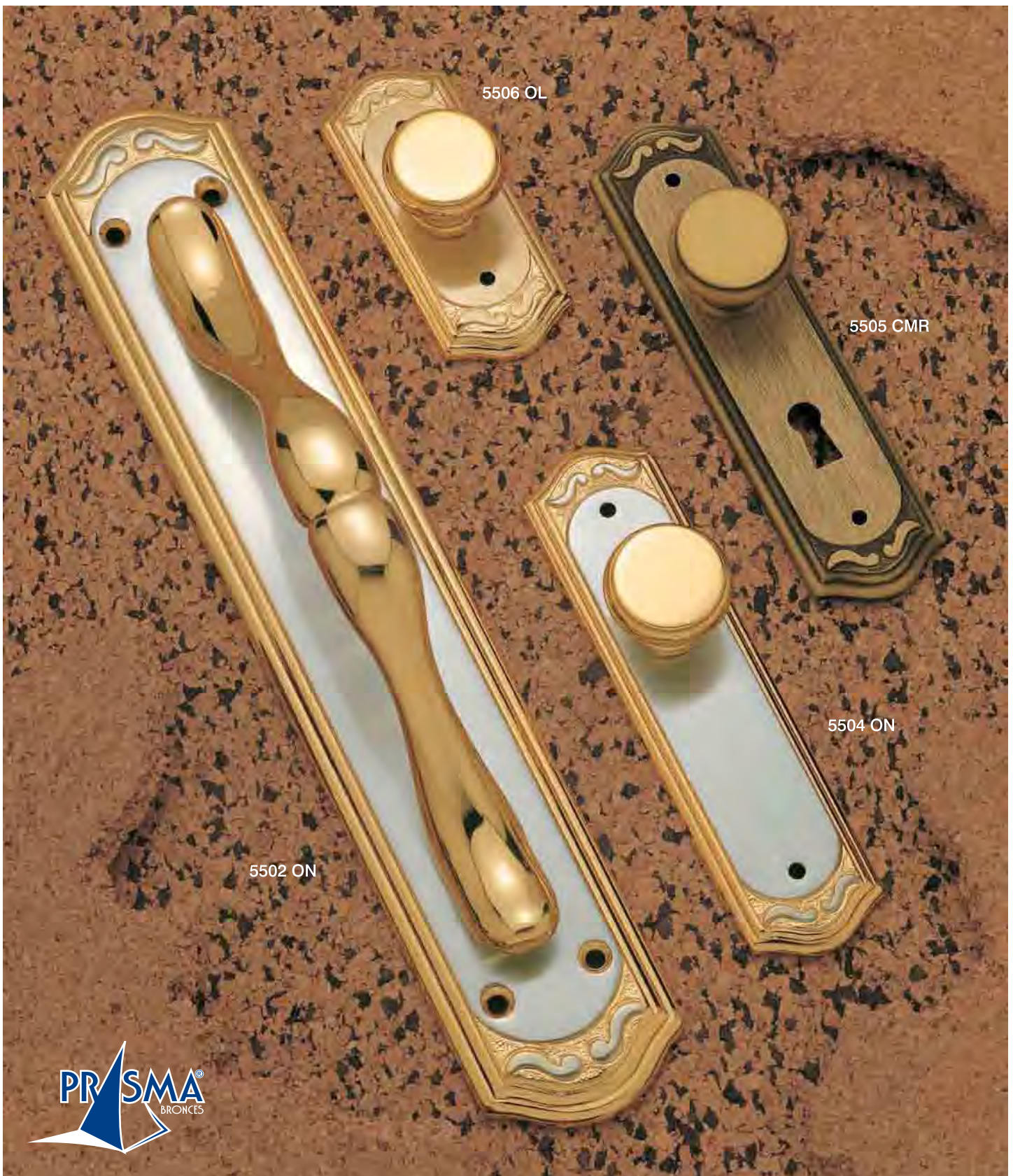

MODELO 0517	DESCRIPCIÓN / DESCRIPTION	MEDIDA / SIZE
01	Juego manivelas / Set handles .....	262 x 48 mm.
02	Asa fija (manillón) / Fixed handle.....	262 x 48 mm.
03	Placa limpieza / Smear plate.....	262 x 48 mm.
04	Pomo armario s/b / s/b Cupboard handle.....	127 x 33 mm.
05	Pomo armario c/b / c/b Cupboard handle.....	127 x 33 mm.
06	Pomo maletero / Large handle .....	80 x 33 mm.
07	Placa c/pomo giratorio / Plate with revolving .....	262 x 48 mm.
08	Manivela grisan / "Grisan" handle .....	127 x 33 mm.

© MARCAS Y MODELOS REGISTRADOS

© REGISTERED TRADE MARK AND MODELS

**ACABADOS:**

Brillo mate, cuero satinado, baño oro, oro niquel, oro lijado, oro rodio, oro grafilado, oro niquel grafilado, bronce inglés, cromo, acero.

**FINISH:**

Dull shine, satin leather, gold finger, nickel gold, sanded gold, rhodium gold, dulled gold, nickel dulled, english bronze, chrome, steel.

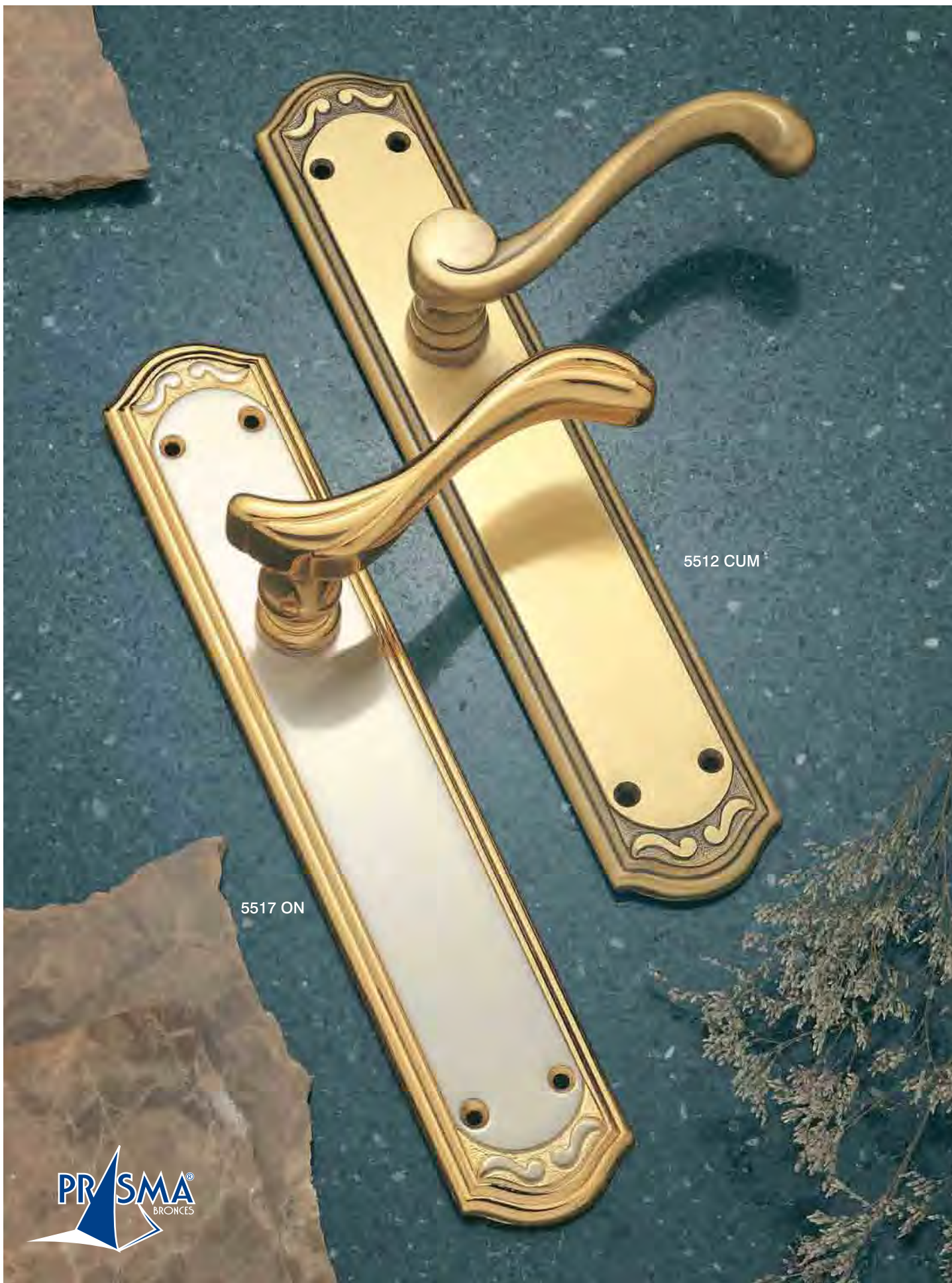

5512 CUM

5517 ON



**ACABADOS / FINISH**

CUS	Cuero satinado /	<i>Satin leather</i>
BM	Brillo mate /	<i>Dull shine</i>
BO	Baño oro /	<i>Gold finger</i>
ON	Oro níquel /	<i>Nickel gold</i>
OL	Oro lijado /	<i>Sanded gold</i>
OR	Oro rodio /	<i>Rhodium gold</i>

**ACABADOS / FINISH**

OG	Oro grafilado /	<i>Dulled gold</i>
ORG	Oro níquel gradilado /	<i>Nickel gold dulled</i>
BR	Bronce inglés /	<i>English bronze</i>
CR	Cromo /	<i>Chrome</i>
ACE	Acero /	<i>Steel</i>

**MODELO / MODEL**

5512
5517

**MEDIDA / SIZE**

262 x 48 mm.
262 X 48 mm.

© MARCAS Y MODELOS REGISTRADOS  
 © REGISTERED TRADE MARK AND MODELS

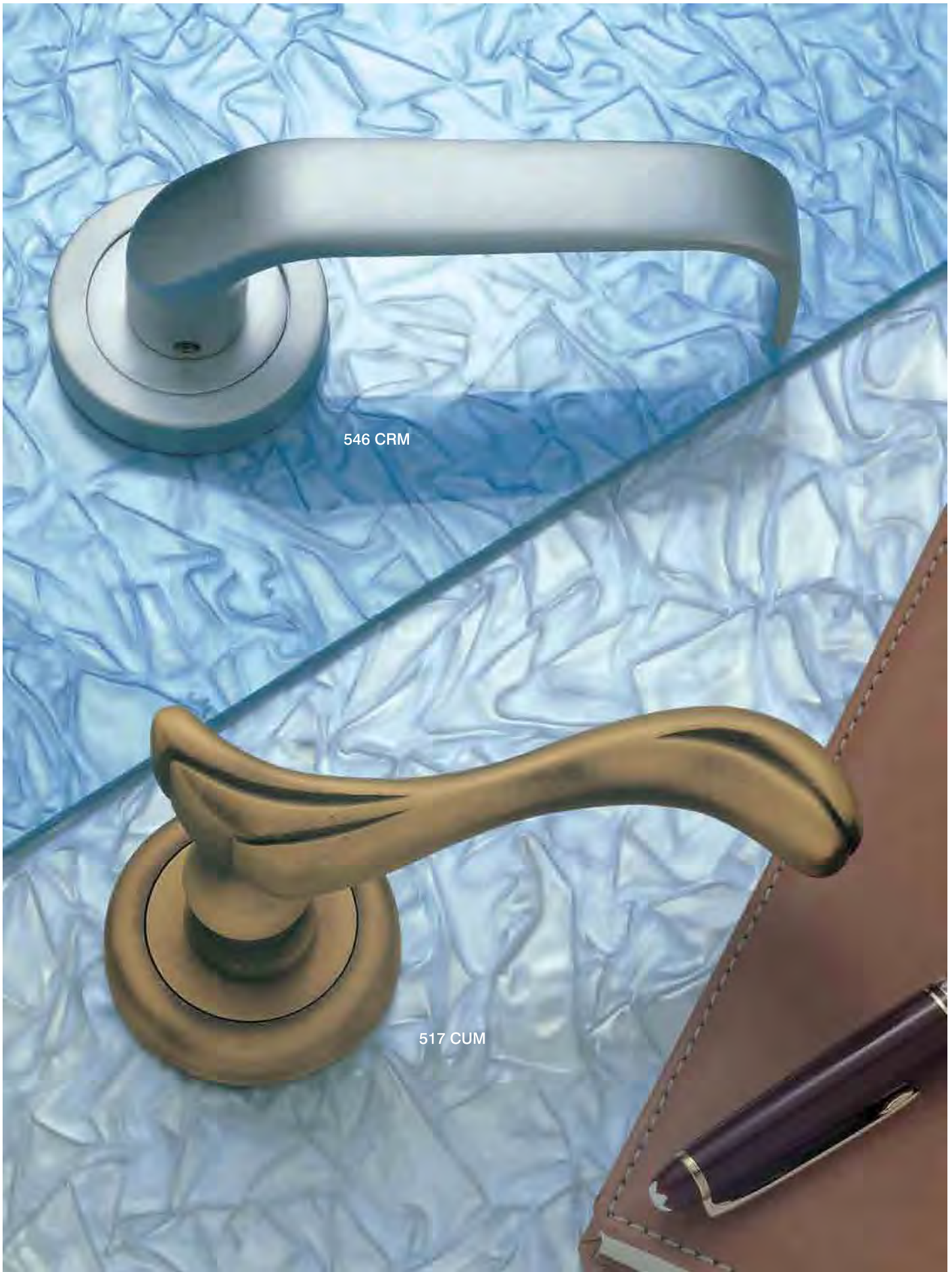

546 CRM

517 CUM

**ACABADOS / FINISH**

BI Bronce inglés / *English bronze*  
 ON Oro níquel / *Nickel gold*  
 CUS Cuero satinado / *Satin leather*

RO Oro rodio / *Gold rhodium*  
 CR Cromo / *Chrome*  
 ACE Acero / *Steel*  
 PB Pulido brillo / *Polished shine*

Modelo / Model 613 P  
 Modelo / Model 613 P PB  
 Modelo / Model 513 P CU  
 Modelo / Model 513 P PB  
 Modelo / Model 513 PR  
 Modelo / Model 308 B PR



613 P



613 P PB



513 P CU



513 P PB



513 PR



308 B PR



**ACABADOS / FINISH**

- |     |                |   |                |
|-----|----------------|---|----------------|
| BIN | Bronce inglés  | / | English bronze |
| LAN | Latón antiguo  | / | Old brass      |
| CUS | Cuero satinado | / | Satin leather  |
| R   | Rodio          | / | Rhodium        |
| CR  | Cromo          | / | Chrome         |

© MARCAS Y MODELOS REGISTRADOS

© REGISTERED TRADE MARK AND MODELS





Modelo / Model 5013 B LAN

Modelo / Model 5013 P BI

Modelo / Model 5013 P CU



5013 P BI

5013 P CU

5013 P LAN

**ACABADOS / FINISH**

BIN	Bronce inglés	/	English bronze
LAN	Latón antiguo	/	Old brass
CUS	Cuero satinado	/	Satin leather

Modelo / Model 620  
 Modelo / Model 530  
 Modelo / Model 525 A  
 Modelo / Model 525 B  
 Modelo / Model 625 B



620 ON



530 ON



525 A PB



525 A ACE



525 B ACE



625 B ACE

**ACABADOS / FINISH**

BIN Bronce inglés / English bronze  
 ON Oro níquel / Nickel Gold  
 CUS Cuero satinado / Satin leather

RO Oro rodio / Gold rhodium  
 CR Cromo / Chrome  
 ACE Acero / Steel  
 PB Pulido Brillo / Polished shine



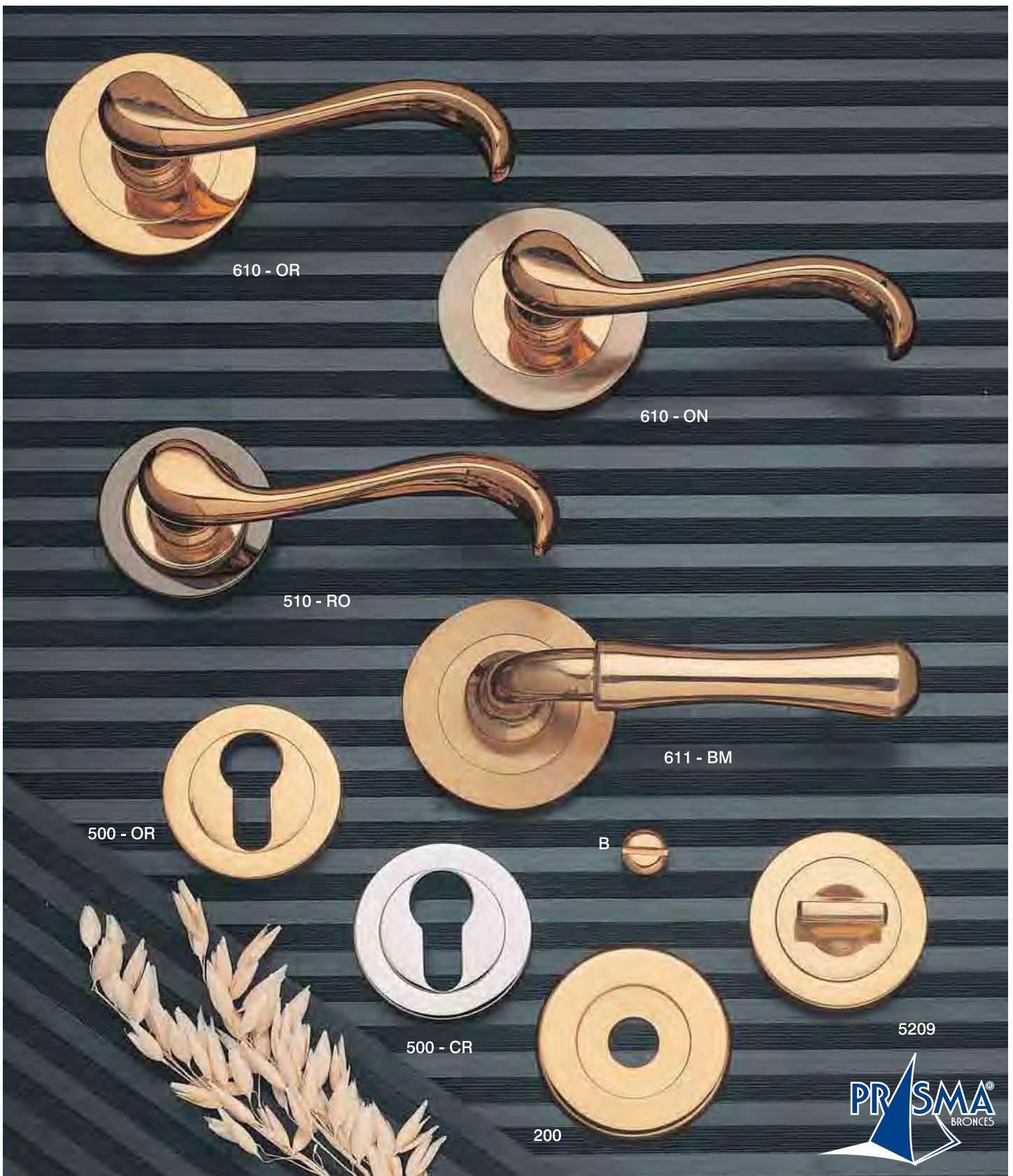

MOD.	DESCRIPCIÓN / DESCRIPTION	
610	Roseta con manivela / Rosette with crank.....	60 mm.
510	Roseta con manivela / Rosette with crank.....	50 mm.
500	Roseta c/b / c/b Rosette .....	50 mm.
600	Roseta c/b / c/b Rosette .....	60 mm.
5209	Roseta con muletilla / Rosette standar key .....	50 mm.
200	Placa mirilla / Shield with peed hole .....	55 mm.
B	Condena desbloqueo / Unblockade handgrip .....	22 mm.

© MARCAS Y MODELOS REGISTRADOS

© REGISTERED TRADE MARK AND MODELS

**ACABADOS:**  
 Brillo mate, cuero satinado, baño oro, oro níquel, oro lijado, oro rodio, oro grafilado, oro níquel grafilado, bronce inglés, cromo, acero.

**FINISH:**  
 Dull shine, satin leather, gold finger, nickel gold, sanded gold, rhodium gold, dulled gold, nickel gold dulled, english bronze, chrome, steel.

Modelo / Model 544 ACE

Modelo / Model 544 PB

Modelo / Model 519 PB

Modelo / Model 545 PB

544 ACE

544 PB

519 PB

545 PB

**ACABADOS / FINISH**

BM	Brillo Mate	/	Dull shine	CR	Cromo	/	Chrome
PB	Pulido Brillo	/	Polished shine	BIN	Bronce Inglés	/	English bronze
OR	Oro	/	Gold	ACE	Acero	/	Steel
LM	Latón Mate	/	Matt brass	LAN	Latón Antiguo	/	Old brass

Modelo / Model 5014 BI  
 Modelo / Model 7080 ON  
 Modelo / Model 3015 CU  
 Modelo / Model 7080 BI



**ACABADOS / FINISH**

BI Bronce inglés / *English bronze*  
 CS Cuero satinado / *Satin leather*  
 ON Oro níquel / *Nickel gold*  
 PB Pulido brillo / *Polished shine*

CM Cuero mate / *Matt leather*  
 CR Cromo / *Chrome*  
 CM Cromo mate / *Matt chrome*  
 OR Oro rodio / *Rhodium gold*

© MARCAS Y MODELOS REGISTRADOS

© REGISTERED TRADE MARK AND MODELS



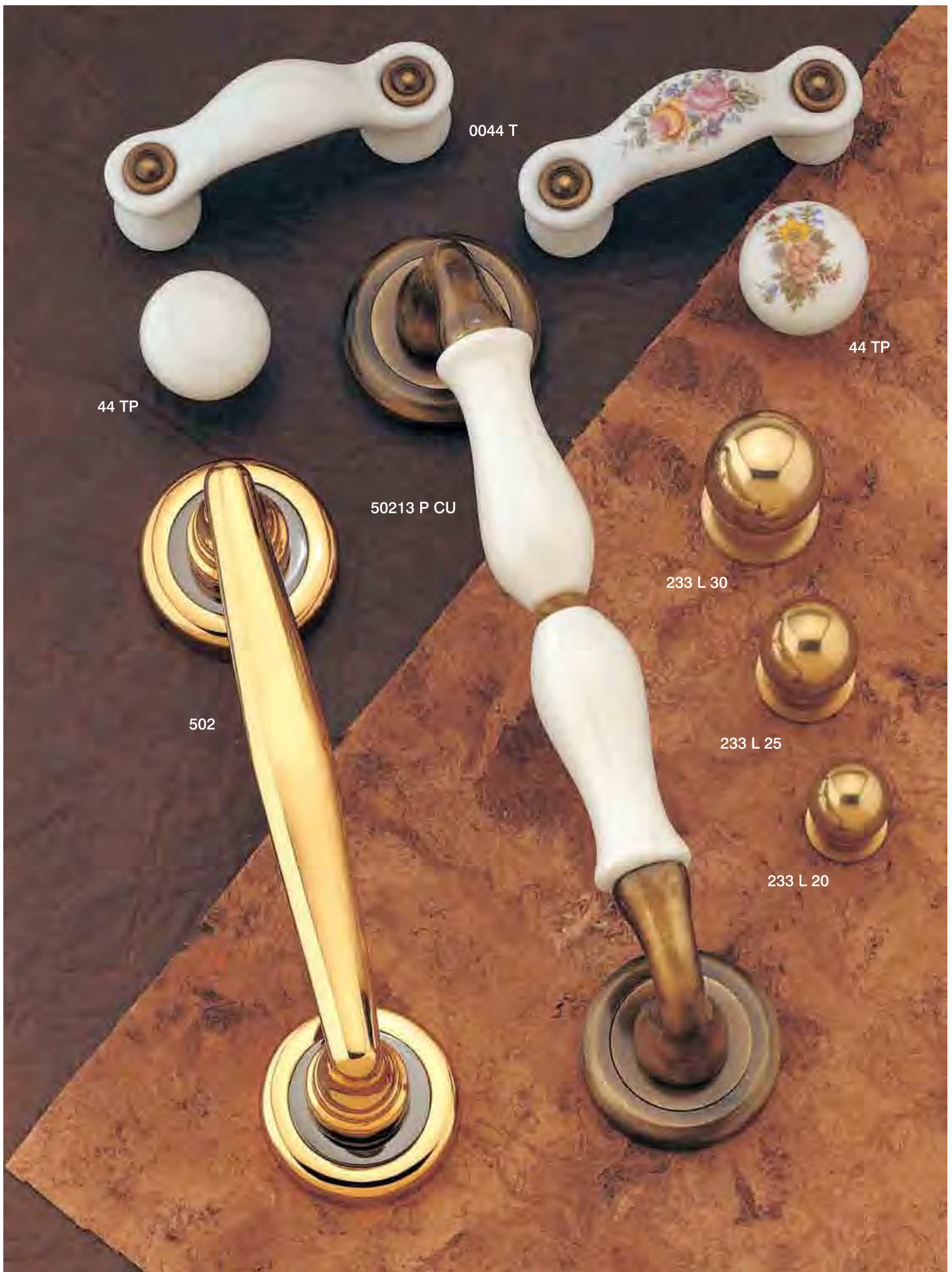

**Modelo / Model 502**

**Modelo / Model 233 L 30**

**Modelo / Model 233 L 25**

**36 Modelo / Model 233 L 20**

**Modelo / Model 50213 P**

**Modelo / Model 0044 T**

**Modelo / Model 44 TP**





991 PB

991 OR

991 BI

990 ACE

990 CU

Modelo / Model 991 PB  
 Modelo / Model 991 OR  
 Modelo / Model 991 BI  
 Modelo / Model 990 ACE  
 Modelo / Model 990 CU

**ACABADOS / FINISH**

BIN	Bronce inglés	/	English bronze
OR	Oro	/	Gold
CUS	Cuero satinado	/	Satin leather
ACE	Acero	/	Steel
CR	Cromo	/	Chrome

**MODELO / MODEL**

911
990

**MEDIDA / SIZE**

90 mm.
90 mm.

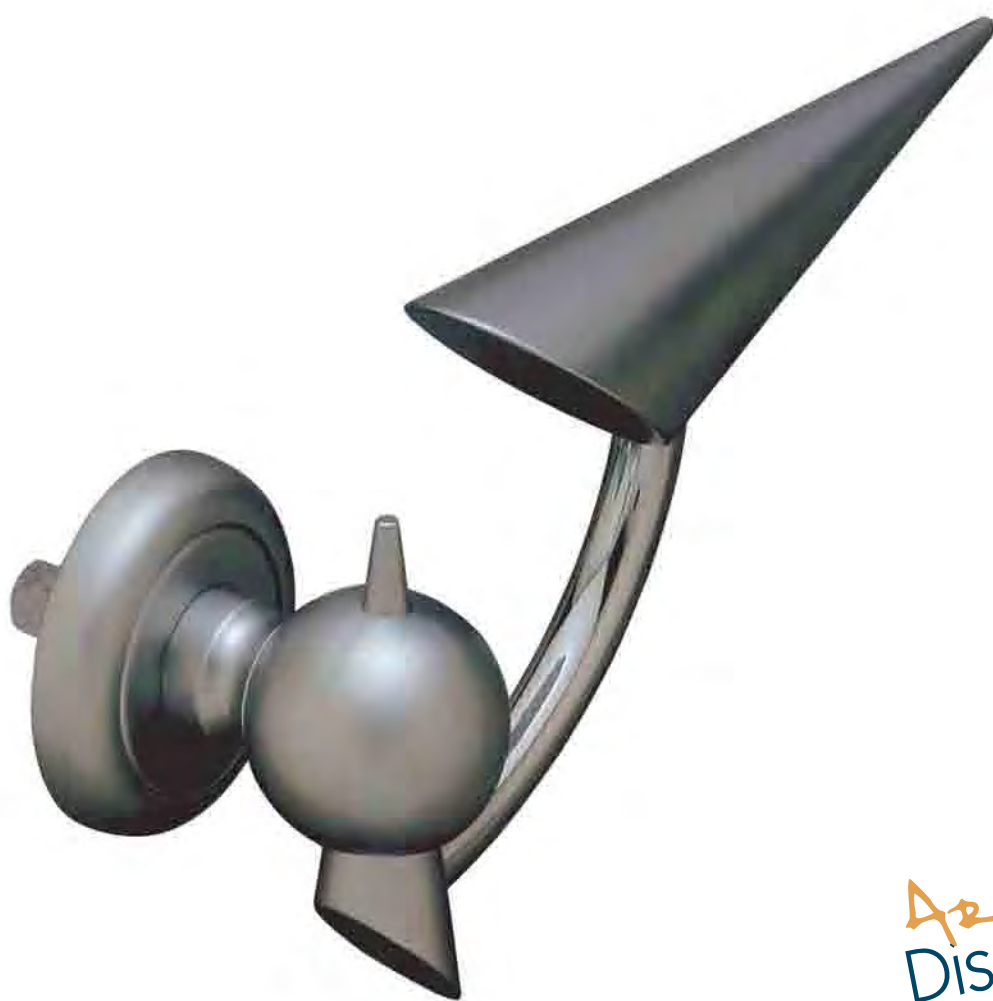

ARTE  
Diseño

© MARCAS Y MODELOS REGISTRADOS    © REGISTERED TRADE MARK AND MODELS

Massimo Collection





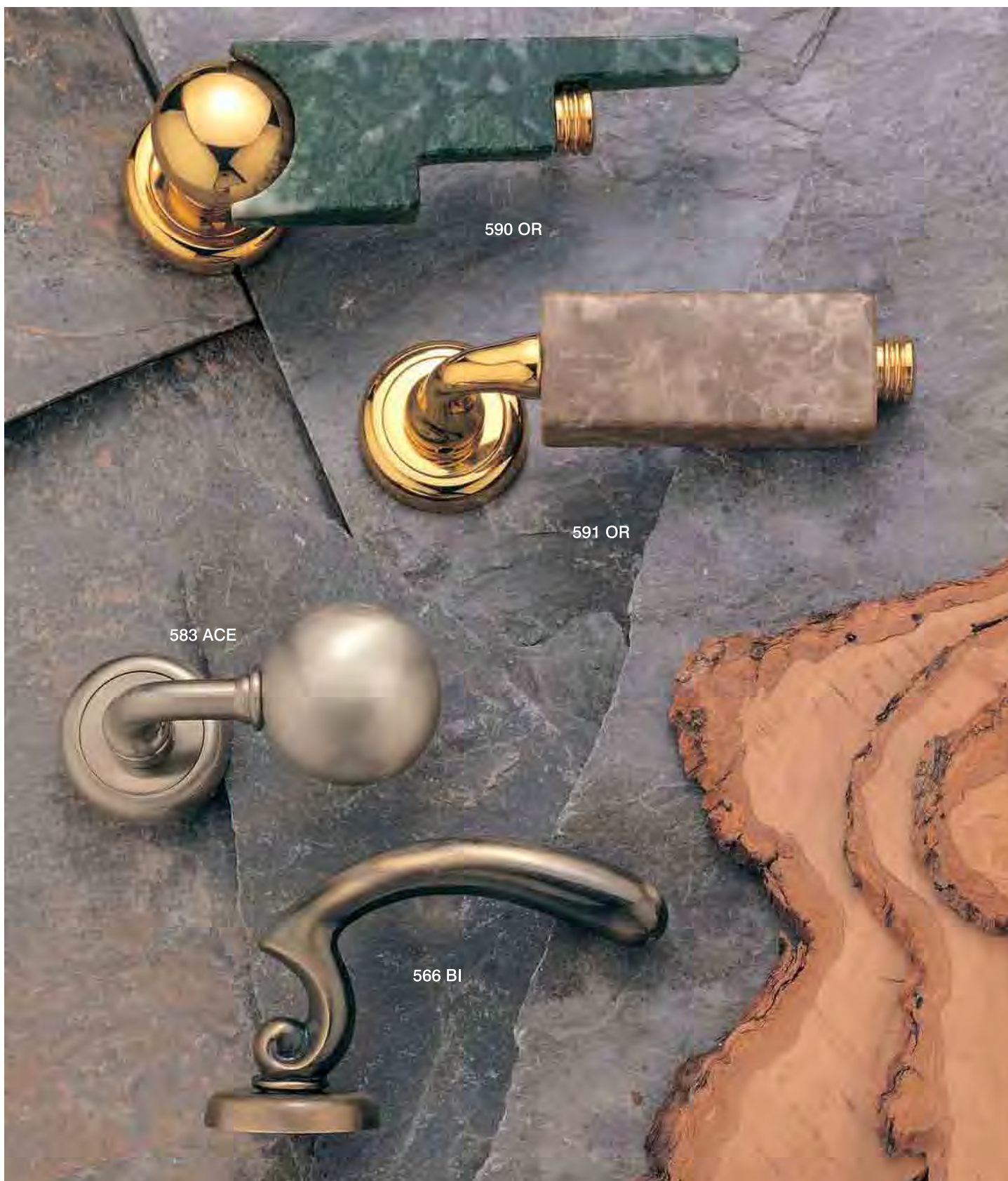

590 OR

591 OR

583 ACE

566 BI

**ACABADOS / FINISH**

BM	Brillo Mate	/	Dull shine
CU	Cuero Satinado	/	Satin leather
OR	Oro	/	Gold
ON	Oro niquel	/	Nickel Gold
TI	Titanio	/	Titan
RO	Oro Rodio	/	Rhodium Gold
OG	Oro Grafilado	/	Dulled Gold
BI	Bronce Inglés	/	English Bronze
CR	Cromo	/	Cromo
ACE	Acero	/	Steel

**MODELO / MODEL**

590 OR	- MÁRMOL
591 OR	- MÁRMOL
583 ACE	
566 BI	

**MEDIDA / SIZE**

Ø50 x 148 mm.
Ø50 x 120 mm.
Ø50 x 96 mm.
Ø50 x 112 mm.



**ACABADOS / FINISH**

© MARCAS Y MODELOS REGISTRADOS

© REGISTERED TRADE MARK AND MODELS

BI Bronce inglés / *English bronze*  
 ON Oro níquel / *Nickel gold*  
 CU Cuero satinado / *Satin leather*  
 RO Oro rodio / *Gold rhodium*

CR Cromo / *Chrome*  
 ACE Acero / *Steel*  
 PB Pulido brillo / *Polished shine*

**MODELO / MODEL**

595 CRM  
 577 ACE  
 577 CU  
 588 CU  
 588 ACE

**MEDIDA / SIZE**

Ø50 x 153 mm.  
 Ø50 x 147 mm.  
 Ø50 x 147 mm.  
 Ø50 x 141 mm.  
 Ø50 x 141 mm.

Modelo / Model 50295 LM  
 Modelo / Model 50211 CUM  
 Modelo / Model 50277 LM  
 Modelo / Model 50271 ACE



50295 LM

50211 CUM

50277 LM

50271 ACE



**ACABADOS / FINISH**

BM	Brillo Mate	/	Dull shine	CR	Cromo	/	Chrome
PB	Pulido Brillo	/	Polished shine	BI	Bronce Inglés	/	English bronze
OR	Oro	/	Gold	ACE	Acero	/	Steel
LM	Latón Mate	/	Matt brass	LAN	Latón Antigo	/	Old brass

**MODELO / MODEL**

50295 LM	Ø50 x 250 mm.
50211 CUM	Ø50 x 230 mm.
50277 LM	Ø50 x 175 mm.
50271 ACE	Ø50 x 190 mm.

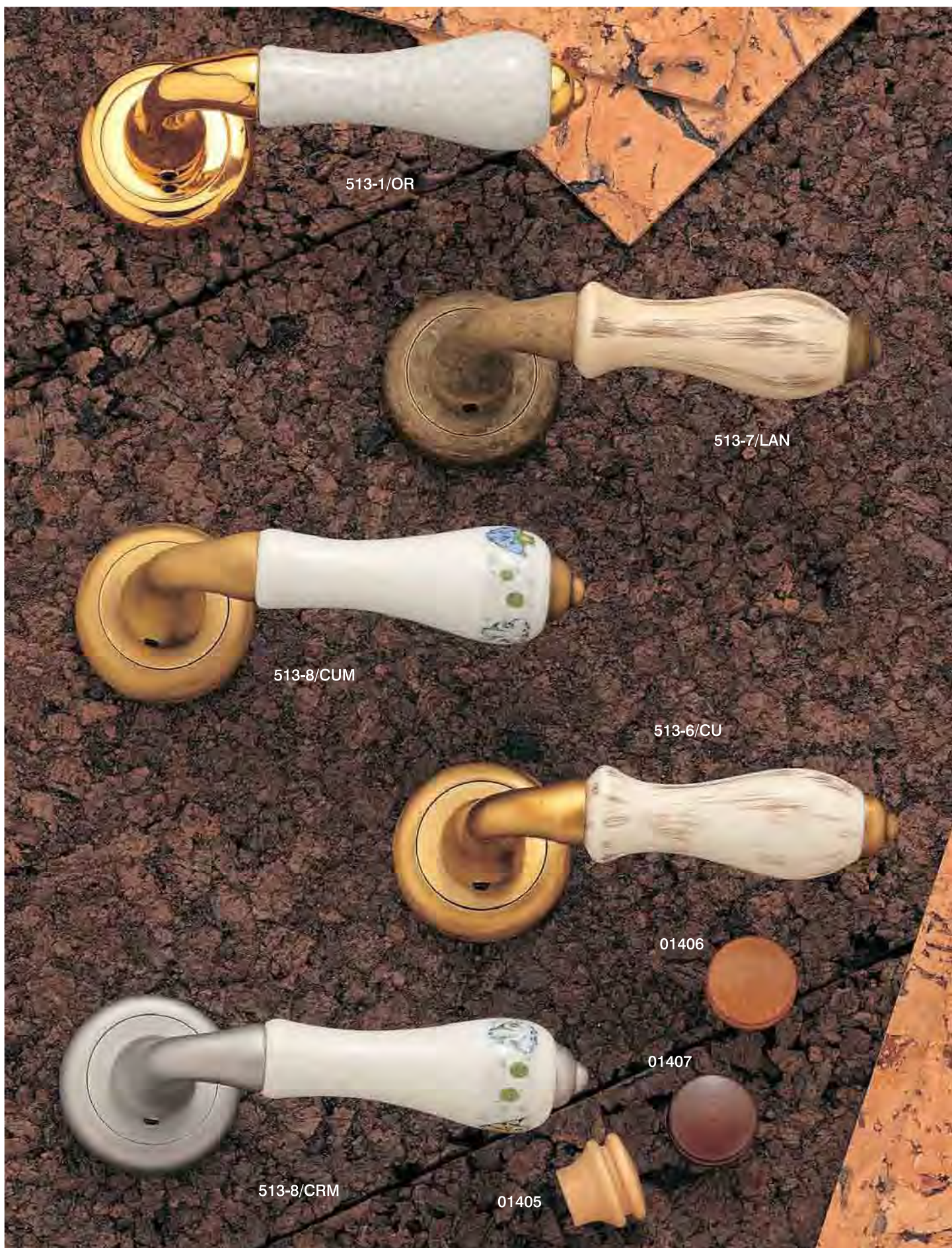

**PORCELANAS DECORADAS EN RÚSTICO Y DISEÑO GAUDDY**  
**PORCELAINS DECORATED IN PEASANT & GAUDDY DESIGN**

**ACABADOS / FINISH**

BI	Bronce inglés	/	<i>English bronze</i>
CU	Cuero satinado	/	<i>Satin leather</i>
CR	Cromo	/	<i>Chrome</i>
ACE	Acero	/	<i>Steel</i>

01405	Madera Haya
01406	Madera Cerezo
01407	Madera Nogal

© MARCAS Y MODELOS REGISTRADOS

© REGISTERED TRADE MARK AND MODELS





2913-5/CU

2913-3/CO

2913-4/CRM

**ACABADOS / FINISH**

- CU    Cuero Satinado / *Satin leather*
- CR    Cromo Mate    / *Matt Chrome*
- CO    Cobre Viejo    / *Old Copper*

**PORCELANAS MACIZAS CRAQUELADAS  
EN DISTINTOS COLORES**

**MASSIVE CRACKED PORCELAINS  
IN DIFFERENT COLORS**

© MARCAS Y MODELOS REGISTRADOS

© REGISTERED TRADE MARK AND MODELS





5513-1/BI

4031 CU

531 CU

**ACABADOS / FINISH**

BM	Brillo Mate	/	Dull shine	CR	Cromo	/	Chrome
CU	Cuero Satinado	/	Satin Leather	BI	Bronce Inglés	/	English bronze
OR	Oro	/	Gold	ACE	Acero	/	Steel
LM	Latón Mate	/	Matt brass	LAN	Latón Antigo	/	Old brass





**ACABADOS / FINISH**

PB Pulido Brillo / Polished shine  
 OR Oro / Gold  
 LM Latón Mate / Matt brass  
 LAN Latón Antiguo / Old brass

CR Cromo / Chrome  
 CRM Cromo Mate / Matt Chrome  
 ACE Acero / Steel  
 BI Bronce Inglés / English bronze

**MODELO / MODEL**

913 ACE PORCELANA  
 913-1/BI POR. CRAQ.  
 913-2/CU POR. CRAQ.  
 98113 PCR/CU

**MEDIDA / SIZE**

Ø 90 mm.  
 Ø 90 mm.  
 Ø 90 mm.  
 82 x 164 mm.



**PORCELANAS MACIZAS CRAQUELADAS Y DECORADAS GAUDDY  
 MASSIVE CRACKED PORCELAINS & GAUDDY DECORATED**

**ACABADOS / FINISH**

ACE	Acero	/ Steel
OR	Oro	/ Gold
CU	Cuero Satinado	/ Satin Leather
CUM	Cuero Mate	/ Matt Leather
BI	Bronce Inglés	/ English Bronze

**MODELO / MODEL**

50213-8 CUM
50225 ACE

**MEDIDA/SIZE**

180mm. Ø50
150mm. Ø50





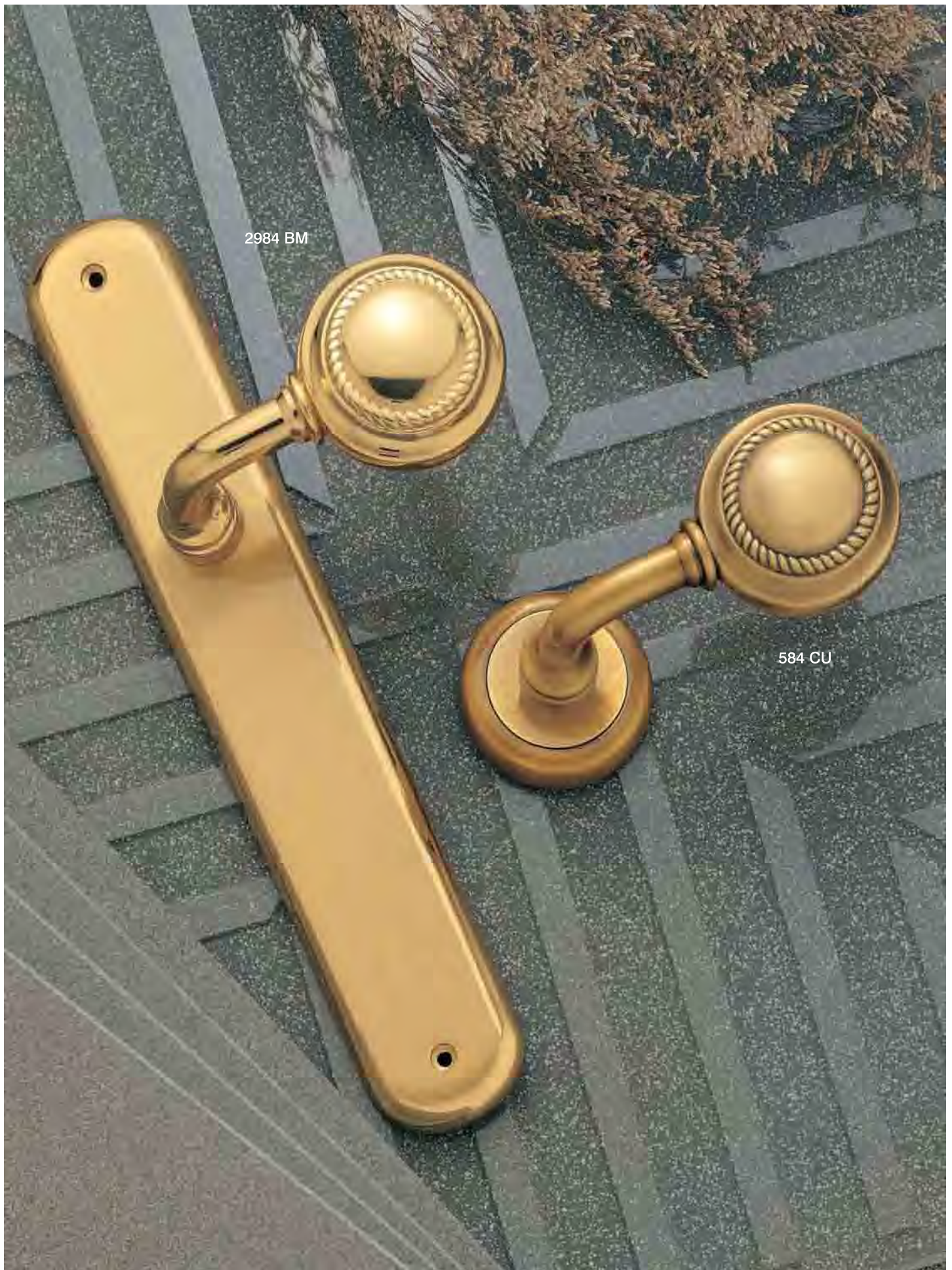

2984 BM

584 CU

**ACABADOS / FINISH**

CR	Cromo	/	Chrome	CU	Cuero Satinado /	Satin Leather
ACE	Acero	/	Steel	BM	Brillo Mate /	Shine Matt
OR	Oro	/	Gold			

© MARCAS Y MODELOS REGISTRADOS

© REGISTERED TRADE MARK AND MODELS





29144 CI

10012 OL

514 OL/R

**ACABADOS / FINISH**

BI Bronce inglés / *English bronze*  
 ON Oro níquel / *Nickel Gold*  
 CU Cuero satinado / *Satin leather*  
 RO Oro rodio / *Gold rhodium*

OL Oro Lijado / *Sanded Gold*  
 ACE Acero / *Steel*  
 PB Pulido Brillo / *Polished shine*  
 514 OL/R - Roble / Oro Lijado  
 29144 CI - Haya / Cuero Inglés



516 OP

5116 CU

2916 CRM

516 CRM



**MANGOS EN PIEL / LEATHER HANDLES**

**ACABADOS / FINISH**

BI Bronce inglés / *English bronze*  
 ON Oro níquel / *Nickel Gold*  
 CU Cuero satinado / *Satin leather*

RO Oro rodio / *Gold rhodium*  
 CR Cromo / *Chrome*  
 ACE Acero / *Steel*  
 PB Pulido Brillo / *Polished shine*

© MARCAS Y MODELOS REGISTRADOS

© REGISTERED TRADE MARK AND MODELS



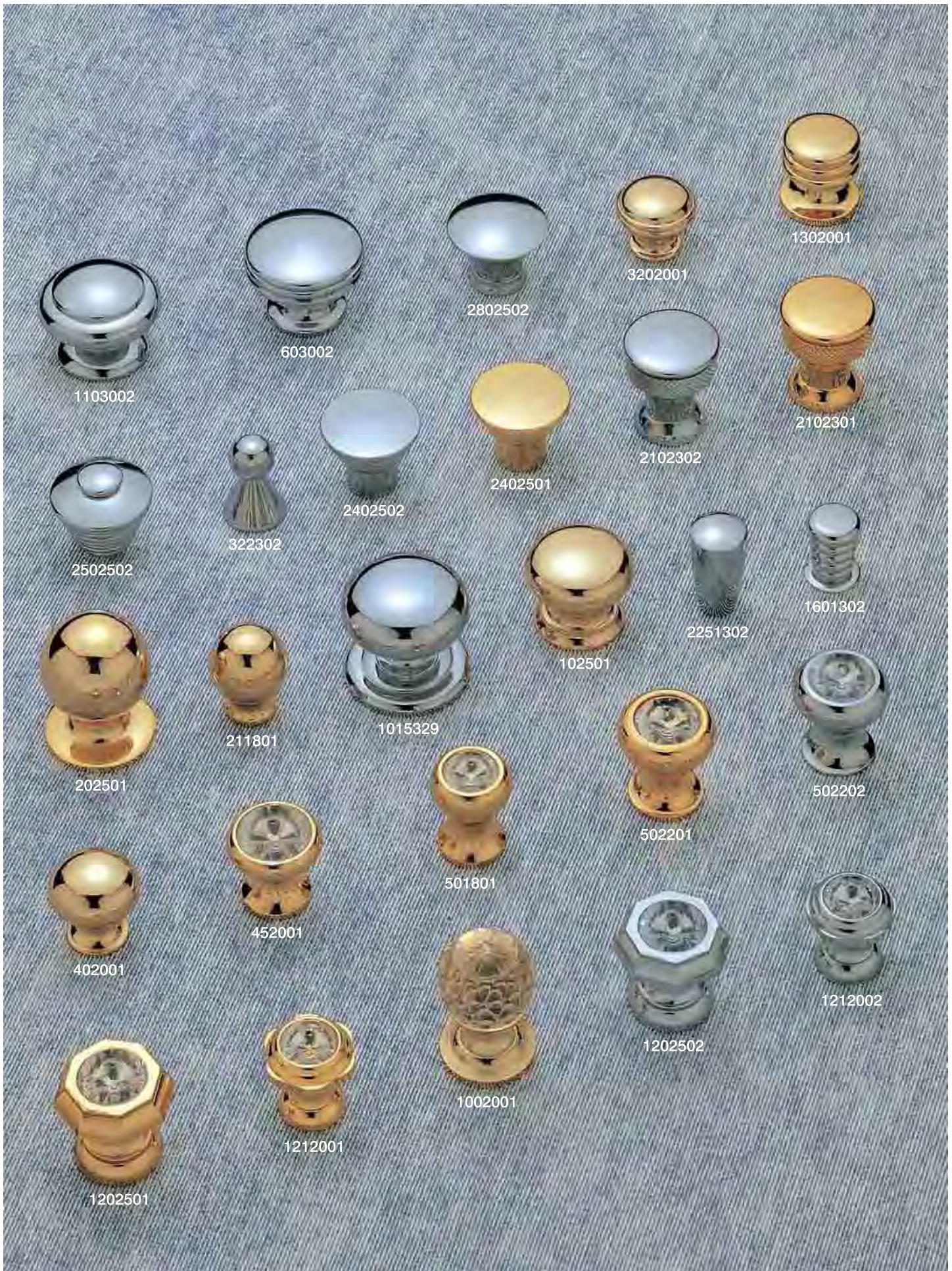

**ACABADOS / FINISH**

BO Baño oro / Gold finger  
 CR Cromo / Chrome

**POMOS DE LATÓN**

© MARCAS Y MODELOS REGISTRADOS  
 © REGISTERED TRADE MARK AND MODELS





0910/46-CRM

**MODELO PERSONALIZABLE**  
**PERSONALIZABLE MODEL**  
**METAL TALLADO**  
**ENGRAVED METAL**



MOD. 595

**ACABADOS / FINISH**

CR	Cromo	/	Chrome	CRM	Cromo Mate	/	Matt Chrome
ACE	Acero	/	Steel	BI	Bronce Inglés	/	English Bronze
OR	Oro	/	Gold				

© MARCAS Y MODELOS REGISTRADOS

© REGISTERED TRADE MARK AND MODELS





7033IRO-STRASS  
57 x 281 mm.

7059RO  
57 x 281 mm.

7080106 STRASS  
57 x 281 mm.

0001 STRASS

4413V OXV  
44 x 150 mm.

513PV NAN  
50 Ø

4413V LAN  
44 x 150 mm.

659 BI  
67 Ø



7059IA  
57 x 281 mm.

9849CU  
82 x 164 mm.

6159CU  
53 x 274 mm.





8192ORO  
59 x 403 mm.

8192CU  
59 x 403 mm.



765ACE  
55 Ø

728ACE  
55 Ø

72713PCR



7213RLAN  
55 Ø

727ACE  
55 Ø

278 XPB  
PULIDO BRILLO

377 CLM  
LATÓN  
MATE

LATÓN MATE

LATON  
ANTIGUO



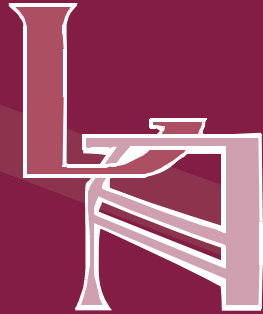

**LINEA ALABAU**  
**BRONCES**

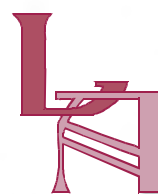

## **LINEA ALABAU BRONCES**

**Nos es grato mostrarles una nueva línea de productos en la cual podemos contemplar los modelos que ustedes ya conocen y las últimas novedades**

**Deseamos que les sea de gran utilidad y así pues, les facilite al máximo su trabajo.**

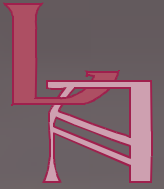

**Mod. 11** a  
**Brillo Satinado**  
**10/01**  
Sat. Brass

**Mod. 10** b  
**Brillo Satinado**  
**10/01**  
Sat. Brass

**260 x 45 mm.**

**Mod. 11** c  
**Cuero**  
**11/01**  
Stark Naked

**Mod. 10** d  
**Cuero**  
**10/01**  
Stark Naked

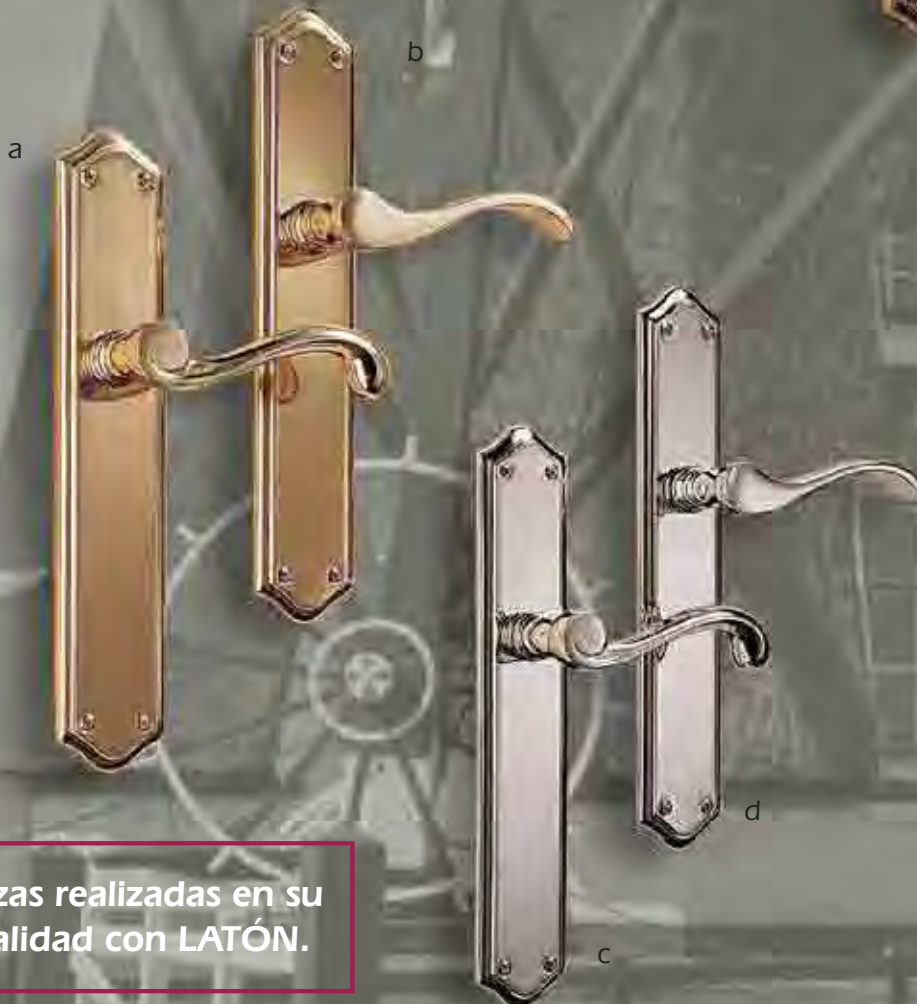

a **Mod. 11**  
**Pulido Brillo**  
**11/01**  
Pol. Brass

b **Mod. 10**  
**Pulido Brillo**  
**10/01**  
Pol. Brass

**260 x 45 mm.**

c **Mod. 11**  
**Cromo**  
**11/01**  
Chrome

d **Mod. 10**  
**Cromo**  
**10/01**  
Chrome

**Piezas realizadas en su  
totalidad con LATÓN.**



a **Mod. 11**  
**Oro Satinado**  
11/01  
Sat. Gold

b **Mod. 10**  
**Oro Satinado**  
10/01  
Sat. Gold

260 x 45 mm.



c **Mod. 11**  
**Oro**  
11/01  
Gold

d **Mod. 10**  
**Oro**  
10/01  
Gold

**Mod. 11 a**  
**Niquel Oro Grafilado**  
11/01  
Gold Niquel Graf.

**Mod. 10 b**  
**Niquel Oro Grafilado**  
11/01  
Gold Niquel Graf.

260 x 45 mm.

**Mod. 11 c**  
**Oro Grafilado**  
11/01  
Gold Graf.

**Mod. 10 d**  
**Oro Grafilado**  
10/01  
Gold Graf.







a **Mod. 11**  
**Oro Platino**  
11/01  
Plat. Gold

b **Mod. 10**  
**Oro Platino**  
10/01  
Plat. Gold

260 x 45 mm.



c **Mod. 11**  
**Rodio / Oro Grafilado**  
11/01  
Gold Black Graf.

d **Mod. 10**  
**Rodio / Oro Grafilado**  
10/01  
Gold Black Graf.

Piezas realizadas en su totalidad  
con LATÓN y baños por  
inmersión de 4 micras

**Mod. 11** a  
**Niquel Oro**  
11/01  
Gold Niquel

**Mod. 10** b  
**Niquel Oro**  
10/01  
Gold Niquel

260 x 45 mm.

**Mod. 11** c  
**Rodio Oro**  
11/01  
Gold Black

**Mod. 10** d  
**Rodio Oro**  
10/01  
Gold Black





**MANILLÓN**  
**Rodio Oro**  
**Mod. 10/02**  
Pull Handle  
Gold Back  
**260 x 45 mm.**

**POMO CON PLACA**  
**Rodio Oro**  
**Mod. 10/11**  
Handle and Plate  
Gold Back  
**260 x 45 mm.**

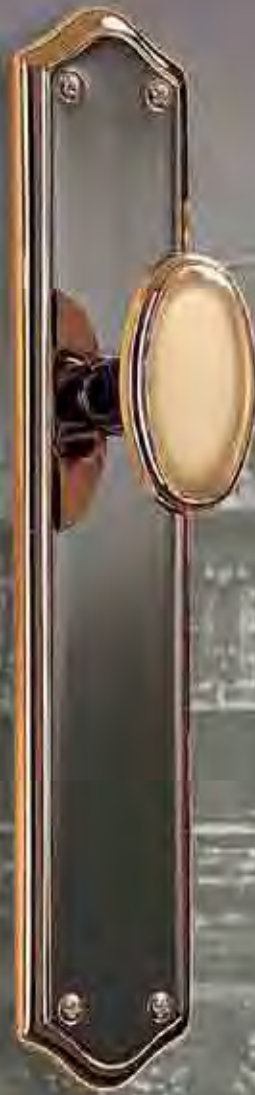

**GRISAN**  
**Rodio Oro**  
**Mod. 10/07**  
Handle for window  
Gold Black  
**120 mm.**



**T.A. - C/B**  
**Rodio Oro**  
**Mod. 10/05**  
Cupboard Pull  
Gold Black  
**120 mm.**



**T.A. - C/B**  
**Rodio Oro**  
**Mod. 10/04**  
Cupboard Pull  
Gold Black  
**120 mm.**



**T.A. - C/B**  
**Rodio Oro**  
**Mod. 10/06**  
Cabinet Pull  
Gold Black  
**80 mm.**

Piezas realizadas en su totalidad con LATÓN y baños por inmersión de 4 micras



**Mod. 21**  
**Oro Satinado**  
21/01  
Sat. Gold  
262 x 48 mm.



**Mod. 21**  
**Niquel Oro**  
21/01  
Gold Nickel  
262 x 48 mm.

**Mod. 21**  
**Oro**  
21/01  
Gold  
262 x 48 mm.



**Mod. 21**  
**Rodio Oro**  
21/01  
Gold Black  
262 x 48 mm.

**Mod. 21**  
**Oro Satinado**  
**21/01**  
Sat. Gold  
**262 x 48 mm.**



**Mod. 21**  
**Cromo**  
**21/01**  
Chrome  
**262 x 48 mm.**

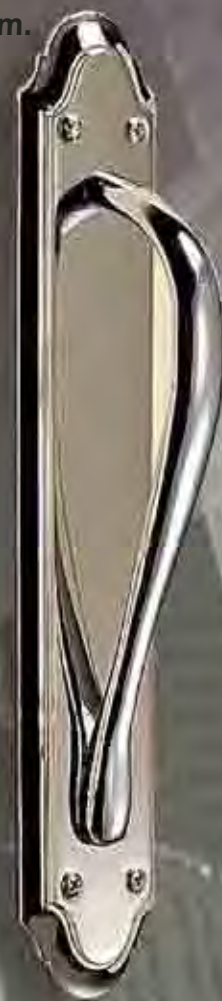

**Mod. 21**  
**Brillo Satinado**  
**21/01**  
Sta. Brass  
**262 x 48 mm.**

Piezas realizadas en su totalidad  
con LATÓN y baños por  
inmersión de 4 micras

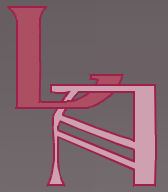

**Mod. 1156 BM**  
**Brillo Mate**  
**270 x 48 mm.**



**Mod. 1251 BM**  
**Brillo Mate**  
**269 x 49 mm.**



**Mod. 701 CU**  
**Cuero Satinado**  
**43 x 240 mm.**

**Mod. 701 BM**  
**Brillo Mate**  
**43 x 240 mm.**



**Mod. 869 ACE**  
**Acero**  
**242 x 45 mm.**

**Mod. 875 BM**  
**Brillo Mate**  
**242 x 45 mm.**



**Mod. 7441 L - 55 - 01**  
**Acero**  
**240 x 40 mm.**



**Mod. U10155M**  
**Acero**  
**50 ø**



Artículos fabricados en Latón

**Mod. 1622BM**  
**Brillo Mate**  
**200 x 41 mm.**  
**Con tornillos pasantes**



**Mod. 522 PB**  
**Pulido Brillo**  
**50 ø**



**Mod. 969 PB**  
**Pulido Brillo**  
**52 Ø**



**Mod. 975 ACE**  
**Acero**  
**52 Ø**

**Mod. 959/33 ACE**  
**Acero Strass**  
**52 Ø**



**Mod. 959 ACE**  
**Acero**  
**52 Ø**



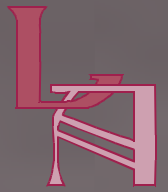

**Mod. 985 PB**  
**Pulido Brillo**  
**52 ø**



**Mod. 974 LM**  
**Latón Mate**  
**52 ø**



**Mod. 976 CRM**  
**Cromo Mate**  
**52 ø**



**Mod. 966 AC BM**  
**Acero Brillo/Mate**  
**52 ø**

Artículos fabricados en Latón



**Mod. 965 ACE**  
**Acero**  
**52 ø**

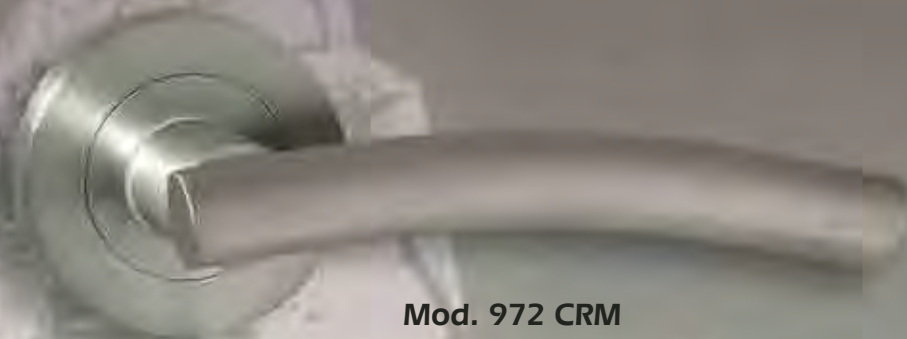

**Mod. 972 CRM**  
**Cromo Mate Escobado**  
**52 ø**

Artículos fabricados en Latón



**Mod. 968 PB**  
**Pulido Brillo**  
**52 ø**



**Mod. 523 ACE**  
**Acero**  
**50 ø**



**Mod.973 ACE**  
**Acero**  
**52 ø**



**Mod. 953 CRM**  
**Cromo Mate Escobado**  
**52 ø**



**Mod.104-228-01 ACE**  
**Acero**  
**52 ø**



**Mod. 970 CUM**  
**Cuero Mate**  
**52 ø**





**Mod. U 10156M**  
Acero  
50 Ø



**Mod.UG 10156 B**  
Acero  
50 Ø

Diseño, Calidad y Elegancia  
en todas sus formas



**Mod. U 10267 L**  
Acero  
50 Ø



**Mod. U 10269 L**  
Acero  
50 Ø



**Mod. UG10165D**  
**Cromo**  
**50 ø**



**Mod. UG 10165 OR**  
**Oro**  
**50 ø**



**Mod. UG 10166 FF**  
**Cromo**  
**50 ø**



**Mod. UG 10166 OR**  
**Oro**  
**50 ø**



**Mod. 3609-BM**  
46x256 mm.

**Herrajes de latón  
con estilo propio**



**Mod. 534 PB**  
50 Ø



**Mod. 535 PB**  
50 Ø

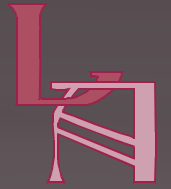

Mod. M5/593  
52 ø



Mod. M6/603  
52 ø



Mod. M2/563  
52 ø



Mod. M4/583  
52 ø

Mod. M7/613  
52 ø





Mod. M1/553  
52 Ø



Mod. M8/623  
52 Ø



Mod. M3/573  
52 Ø



Mod. 5200 INOX  
52 Ø



Mod. 3507 INOX  
35 Ø





Mod. 345 ACE  
30x65 mm.



Mod. 318 PB  
30x65 mm.



Mod. 311 CUM  
30x65 mm.



Mod. P154-CU  
154 Ø



Mod. 307-LM  
30x65 mm.

Tiradores de Porcelana



Mod. 0045  
30 ø



Mod. 0049  
30 ø



Mod. 0047  
30 ø



Mod. 0046  
30 ø



Mod. 0048  
30 ø



Mod. C054  
33 ø



Mod. C050  
33 ø



Mod. C052  
33 ø



Mod. C051  
33 ø



Mod. C053  
33 ø



Mod. C055  
33 ø



Mod. C056  
33 ø



Mod. C057  
33 ø

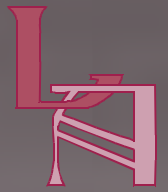

**Mod. U10175A**  
Acero Brillo/Mate  
50 Ø



**Mod. U10177**  
Acero/Rodio  
50 Ø



**Mod. U10174**  
Rodio  
50 Ø

Mod. AL20122L

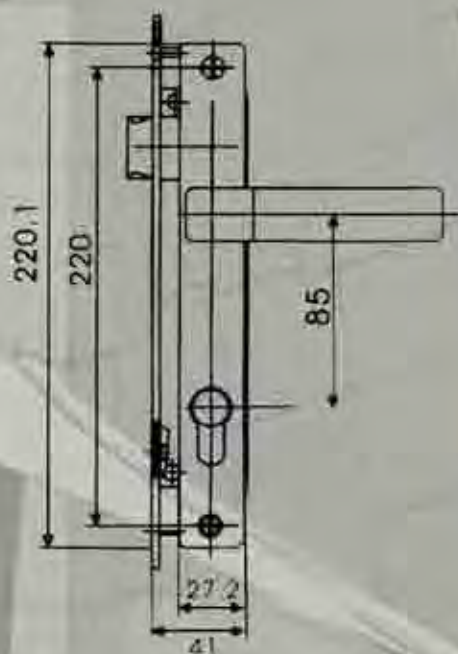

## BRONCES PRISMA

Mod.	Pag.	Mod.	Pag.	Mod.	Pag.	Mod.	Pag.	
0044 T	36	3509	25	5506	27	1156	67	
011	45	322302	50	5512	28	1251	67	
012	45	3202001	50	5517	26-28	1622	69	
013	45	44 TP	36	50211	41	20	66	
014	45	4011	14-24	50225	46	21	65-66	
01405	42	4025 B	24	50271	41	307	79	
01406	42	4030	20	50277	41	311	79	
01407	42	4031	44	50295	41	318	79	
015	45	4413V	53	501801	50	345	79	
016	45	4413V	53	502201	50	3507	78	
017	45	402001	50	502202	50	3609	76	
0001	52	452001	50	610	33	522	69	
0910/46	51	500	33	611	33	523	72	
1025 A	21-22	500 /A	9	613 P	30	5200	78	
1025 B	22	501 /A	11	618	16	534	76	
1002	23	5013 B	31	620	32	535	76	
1004	23	5013 P	31	659	53	701	68	
1006	23	502	36	6004	9	7441L 55 01	69	
1008	23	50213 P	36	6005	9	869	68	
1030	20	50213-8	46	6006	9	875	68	
10012	48	510	33	6020	5-8	953	73	
102501	50	513 P	30	6033	2-4-5	959	70	
1002001	50	513 PR	30	6159	54	959/33	70	
1015329	50	513-1	42	6180	17	965	72	
1103002	50	513-6	42	600233	3	966	71	
1202501	50	513-7	42	600433	3	968	72	
1202502	50	513-8	42	600533	3	969	70	
1212001	50	513PV	53	600633	3	970	73	
1212002	50	514	17-48	603002	50	972	72	
1302001	50	516	49	727	57	973	73	
1601302	50	517	29	728	56	974	71	
200	33	519	34	765	56	975	70	
209 /B	11	525 A	32	7004	7	976	71	
209 MB	20	525 B	32	7005	7	985	71	
233 L 20	36	530	32	7006	7	AL20122L	82	
233 L 25	36	531	44	7059	52-54	C050	80	
233 L 30	36	533	4	7080	6-35	C051	80	
278	57	544	34	7213	57	C052	80	
2913-3	43	545	34	70055	7	C053	80	
2913-4	43	546	29	70331	52	C054	80	
2913-5	43	550213-2	46	72713	56	C055	80	
2010	19	5513-1	44	7080106	52	C056	80	
2916	49	566	39	8192	55	C057	80	
2918	16	577	40	913	45	M1/553	78	
2984	47	583	39	913-1	45	M2/563	77	
29144	48	584	47	913-2	45	M3/573	78	
202501	50	588	40	990	37	M4/583	77	
211801	50	590	39	991	37	M5/593	77	
2102301	50	591	39	9849	54	M6/603	77	
2102302	50	595	40	98113-5	45	M7/613	77	
2251302	50	599	38	B	33	M8/623	78	
2402501	50	5002	11			P154	79	
2402502	50	5004	11			U10155M	69	
2502502	50	5005	11	<b>LINEA ALABAU</b>			U10156M	74
2802502	50	5006	11			U10174	81	
308 B PR	30	5007	12			U10175A	81	
377	57	5010	10-12	0045	80	U10177	81	
3002	15	5014	35	0046	80	U10267L	74	
3004	15	5111	18	0047	80	U10269L	74	
3005	15	5116	49	0048	80	UG10156B	74	
3006	15	5209	33	0049	80	UG10165D	75	
3010	14	5502	27	10 61-62-63-64		UG10165OR	75	
3015	35	5504	27	11 61-62-63-64		UG10166FF	75	
3409	25	5505	27	104/228/01	73	UG10166OR	75	