

Profi Plus

Gama Inset 18/10

Profi Plus

NOVEDAD 90 cm

TOTALES: 860 x 540  
 ENCASTRE: 840 x 520  
 CUBETA GRANDE: 500 x 400 x 226  
 CUBETA PEQUEÑA: 233 x 335 x 176

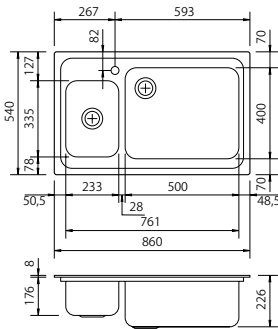

CÓDIGO	ACABADO	UNIDADES	PRECIO
1487 061	A. Inox 18/10	1	660 €

· Sifón espacio incluido

Ejemplo de uso del set modular de accesorios para el fregadero Profi Plus.



Complementos

Grifería recomendada

 <p><b>Escurre verduras</b>                  Cod: 8154-000                  Medidas: 27 x 37                  Acabado: A. Inox                  Precio: 151 €</p>	 <p><b>Tabla de corte</b>                  Cod: 8644-054                  Medidas: 48 x 30                  Acabado: Madera                  Precio: 187 €</p>	 <p><b>Porta vajilla</b>                  Cod: 8100-154                  Medidas: 25 x 35                  Acabado: A. Inox                  Precio: 60 €</p>	 <p><b>Eagle</b>                  Cod: 60556-21                  Acabado: Cromo brillo                  Precio: 960 €                  Ver pág: 165</p>
 <p><b>Válvula Automática</b>                  Cod: 8407-100                  Acabado: A. Inox                  Precio: 60 €</p>	 <p><b>Dosificador Jabón</b>                  Cod/Acabado/Precio:                  2417-21/Cromado/93 €                  2417-31/Inox/102 €</p>	 <p><b>Soporte vajilla para cubeta</b>                  Cod: 6540-40                  Acabado: A. Inox                  Precio: 57 €</p>	
 <p><b>Escurrepasta redondo</b>                  Cod: 8153-000                  Acabado: A. Inox                  Precio: 39 €</p>	 <p><b>Soporte escurrepasta</b>                  Cod: 6525-40                  Acabado: A. Inox.                  Precio: 47 €</p>	 <p><b>Cubeta gastronorm y perforada</b>                  Cod: 784/785                  Acabado: A.Inox                  Precio: 90/90 €</p>	

# Uragano

## Gama Inset 18/10



### Uragano



CÓDIGO	ACABADO	UNIDADES	PRECIO
1555	A. Inox 18/10	1	395 €

· Sifón incluido.

## Uragano | Gama Inset 18/10

100 cm

TOTALES: 970 x 500  
 ENCASTRE: 950 x 480  
 CUBETA: 910 x 440 x 220

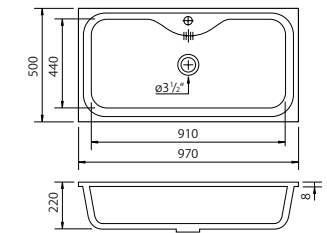

### Complementos



**Porta Vajilla**  
 Cod: 8100-111  
 Acabado: A. Inox  
 Precio: 48 €



**Soporte para cubeta grande o tabla de corte**  
 Cod: 8100-112  
 Acabado: A. Inox  
 Precio: 38 €



**Cubeta perforada**  
 Cod: 8151-100  
 Acabado: Blanco  
 Precio: 35 €



**Tabla de corte Haya**  
 Cod: 8659-112  
 Acabado: Madera  
 Precio: 59 €



**Cubeta grande con válvula**  
 Cod: 8153-000  
 Acabado: Blanco  
 Precio: 45 €



**Valvula automática**  
 Cod: 8407-100  
 Acabado: A. Inox  
 Precio: 60 €



**Soporte escurred.**  
 Cod: 8659-113  
 Acabado: Madera  
 Precio: 70 €



**Escurrepasta**  
 Cod: 8153-000  
 Acabado: A. Inox  
 Precio: 39 €

### Grifería recomendada



**Hole**  
 Cod: 60525-21  
 Acabado: Cromo brillo  
 Precio: 465 €  
 Ver pág: 166

# Tornado

## Gama Inset 18/10



### Tornado Soft



CÓDIGO	ACABADO	UNIDADES	PRECIO
1679-660	A. Inox 18/10	1	325 €

- Sifón incluido.
- Válvula automática incluida

### Tornado Recto



CÓDIGO	ACABADO	UNIDADES	PRECIO
1579-660	A. Inox 18/10	1	300 €

- Sifón incluido.
- Válvula automática incluida

## Tornado | Gama Inset 18/10

80 cm

TOTALES: 790 x 500  
ENCASTRE: 770 x 480  
CUBETA: 730 x 440 x 215

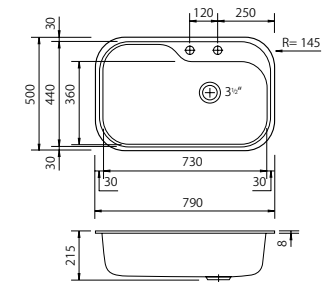

80 cm

TOTALES: 790 x 500  
ENCASTRE: 770 x 480  
CUBETA: 730 x 440 x 215

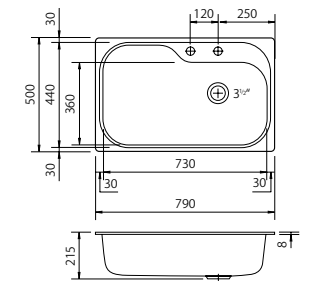

#### Complementos



**Porta Vajilla**  
Cod: 8100-111  
Acabado: A. Inox  
Precio: 48 €



**Soposte para cubeta grande o tabla de corte**  
Cod: 8100-112  
Acabado: A. Inox  
Precio: 38 €



**Cubeta perforada**  
Cod: 8151-100  
Acabado: Blanco  
Precio: 35 €



**Tabla de corte Haya**  
Cod: 8659-111  
Acabado: Madera  
Precio: 59 €



**Cubeta grande con válvula**  
Cod: 8153-000  
Acabado: Blanco  
Precio: 45 €



**Dosificador Jabón**  
Cod/Acabado/Precio:  
2417-21/Cromado/93 €  
2417-31/Inox/102 €



**Soposte cubeta**  
Cod: 8659-110  
Acabado: Madera  
Precio: 70 €



**Cubeta perforada redonda**  
Cod: 8153-000  
Acabado: A. Inox  
Precio: 39 €



**Valvula automática**  
Cod: 8407-100  
Acabado: A. Inox  
Precio: 60 €  
**INCLUIDA**

#### Grifería recomendada



**Pitch**  
Cod: 60551-21  
Acabado: Cromo brillo  
Precio: 560 €  
Ver pág: 167

## ■ Tornado "El original"

Desde su aparición le han salido muchos imitadores pero ninguno llega a igualarlo, porque todo "él" es único.

Único en líneas, en formas, acabados y de generosas medidas interiores, que por medio de una gama muy completa de accesorios se personaliza al gusto del cliente.

## El fregadero que más posibilidades tiene del mercado...



Convertimos en reversible el fregadero utilizando el accesorio soporte de cubeta grande blanca o tabla de corte

Cubeta grande blanca con válvula incorporada más soporte vajilla de acero inoxidable



Soporte inox más tabla de corte



Ejemplo de uso tabla de corte y soporte vajilla



Otro ejemplo de la versatilidad de el fregadero y sus accesorios

Soporte tabla de corte con escurrerasta redondo integrado



Set tabla de corte con escurrerasta redondo Inox incorporado



Set tabla de corte con escurrerasta redondo Inox más soporte vajilla



### Scirocco 11



CÓDIGO	ESCURRIDOR	ACABADO	UNIDADES	PRECIO
100181-02	Derecha	A. Inox 18/10	1	345 €
100180-01	Izquierda	A. Inox 18/10	1	345 €

- Válvula automática incluida.
- Sifón incluido.

### Scirocco 12



CÓDIGO	ESCURRIDOR	ACABADO	UNIDADES	PRECIO
100243-02	Derecha	A. Inox 18/10	1	360 €
100242-01	Izquierda	A. Inox 18/10	1	360 €

- Válvula automática incluida.
- Sifón incluido.

### Scirocco 15



CÓDIGO	ESCURRIDOR	ACABADO	UNIDADES	PRECIO
100756-02	Derecha	A. Inox 18/10	1	430 €
100755-01	Izquierda	A. Inox 18/10	1	430 €

- Válvula automática incluida.
- Sifón incluido.

#### Complementos



Tabla de corte PEHD  
Cod: 40000025  
Acabado: Blanco  
Precio: 65 €



Tabla de corte PEHD  
Cod: 40000023  
Acabado: Blanco  
Precio: 65 €



Dosificador Jabón  
Cod/Acabado/Precio:  
2417-21/Cromado/93 €  
2417-31/Inox/102 €  
**Sólo para Scirocco 12**



Cesta vajilla  
Cod: 40000007  
Acabado: A. Inox.  
Precio: 70 €



Válvula automática  
Cod: 40000108  
Acabado: Inox  
Precio: 60 €  
**INCLUIDA**



Cesta Vajilla  
Cod: 40000006  
Acabado: A. Inox  
Precio: 68 €



Cubetilla perforada  
Cod: 40000040  
Acabado: A. Inox  
Precio: 60 €

#### 45 cm

TOTALES: 900 x 500  
ENCASTRE: 884 x 484  
CUBETA: 332 x 420 x 170

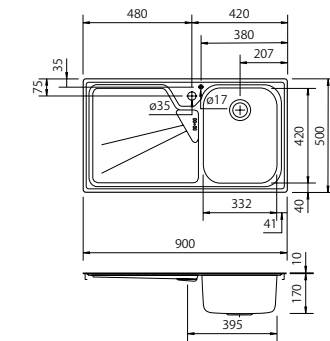

#### 60 cm

TOTALES: 1000 x 500  
ENCASTRE: 984 x 484  
CUBETA: 498 x 346 x 170

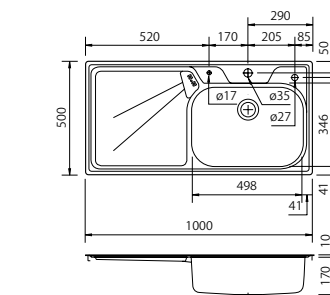

#### 60 cm

TOTALES: 1000 x 500  
ENCASTRE: 984 x 480  
CUBETA GRANDE: 332 x 420 x 170  
CUBETA PEQUEÑA: 162 x 300 x 120

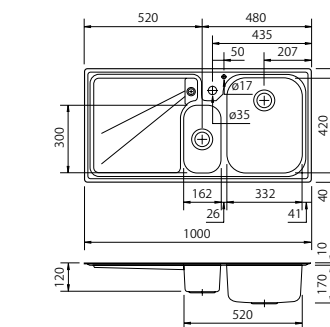

#### Grifería recomendada



Sand  
Cod: 60500-21  
Acabado: Cromo brillo  
Precio: 395 €  
Ver pág: 169



Twin 11



Fondo Cubeta 20cm

CÓDIGO	ESCURRIDOR	ACABADO	UNIDADES	PRECIO
1381-062	Derecha	A. Inox 18/10	1	275 €
1381-061	Izquierda	A. Inox 18/10	1	275 €

· Sifón incluido.

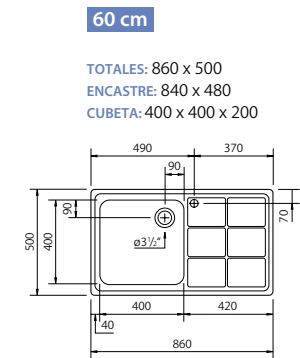

Twin 15



Fondo Cubeta 20cm

CÓDIGO	ESCURRIDOR	ACABADO	UNIDADES	PRECIO
1363-062	Derecha	A. Inox 18/10	1	350 €
1363-061	Izquierda	A. Inox 18/10	1	350 €

· Sifón incluido.

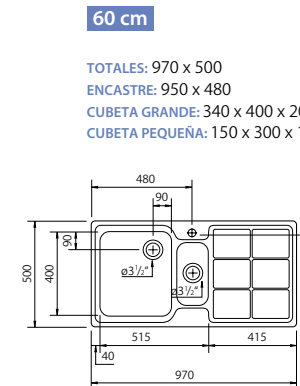

Twin 20



Fondo Cubeta 20cm

CÓDIGO	ACABADO	UNIDADES	PRECIO
1382-062	A. Inox 18/10	1	415 €

· Sifón incluido.

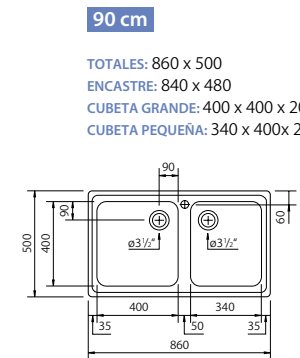

Twin 21



Fondo Cubeta 20cm

CÓDIGO	ESCURRIDOR	ACABADO	UNIDADES	PRECIO
1312-062	Derecha	A. Inox 18/10	1	540 €
1312-061	Izquierda	A. Inox 18/10	1	540 €

· Sifón incluido.

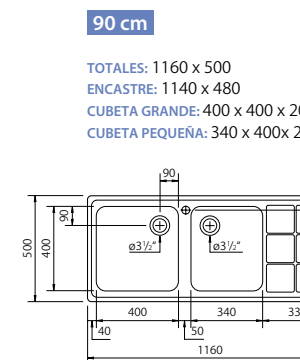

Complementos

 Soporte vajilla para cubeta  
 Cod: 6540-40  
 Acabado: A. Inox  
 Precio: 57 €

 Cubetilla perforada  
 Cod: 8101/000  
 Acabado: A. Inox  
 Precio: 51 €

 Tabla de corte Haya  
 Acabado: Madera  
 Cod/Medidas/Precio:  
 8647-000/34 x 40/75 €  
 8646-000/40 x 40/81 €  
 8643-000/30 x 54/105 €

 Soporte escurrepasta  
 Cod: 6525-40  
 Acabado: A. Inox.  
 Precio: 47 €

 Escurrepasta redondo  
 Cod: 8153-000  
 Acabado: A. Inox  
 Precio: 39 €

 Valvula automática  
 Cod: 8407-100  
 Acabado: A. Inox  
 Precio: 60 €

Grifería recomendada

 Fade extraíble  
 Cod: 60511-21  
 Acabado: Cromo brillo  
 Precio: 555 €  
 Ver pág: 168

# Big Bowl

## Gama Inset 18/10



### ■ BiB 10



CÓDIGO	ACABADO	UNIDADES	PRECIO
1611	A. Inox 18/10	1	156 €

### ■ BiB 11 Soft y Recto



Versión esquinas rectas

CÓDIGO	ESCURRIDOR	BORDE	ACABADO	UNIDADES	PRECIO
1661-02	Derecha	Soft	A. Inox 18/10	1	155 €
1561-02	Derecha	Recto	A. Inox 18/10	1	145 €
1661-01	Izquierda	Soft	A. Inox 18/10	1	155 €
1561-01	Izquierda	Recto	A. Inox 18/10	1	145 €

### ■ BiB 20 Soft y Recto



Versión esquinas rectas

CÓDIGO	CUBETILLA	BORDE	ACABADO	UNIDADES	PRECIO
1662-02	Derecha	Soft	A. Inox 18/10	1	190 €
1562-02	Derecha	Recto	A. Inox 18/10	1	185 €
1662-01	Izquierda	Soft	A. Inox 18/10	1	190 €
1562-01	Izquierda	Recto	A. Inox 18/10	1	185 €

### ■ BiB 21 Recto



CÓDIGO	ESCURRIDOR	ACABADO	UNIDADES	PRECIO
1512-02	Derecha	A. Inox 18/10	1	225 €
1512-01	Izquierda	A. Inox 18/10	1	225 €

#### Complementos



**Valvula automática**  
Cod: 8407-100  
Acabado: A. Inox  
Precio: 60 €



**Tabla de corte Haya**  
Cod: 8655-000  
Medidas: 45 x 40  
Acabado: Madera  
Precio: 60 €



**Tabla de corte Haya**  
Cod: 8653-000  
Medidas: 29 x 40  
Acabado: Madera  
Precio: 63 €



**Cesta vajilla**  
Cod: 8612-000  
Medidas: 40 x 40  
Acabado: A. Inox.  
Precio: 80 €

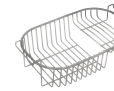

**Soporte escurrepasta**  
Cod: 9525-40  
Acabado: A. Inox.  
Precio: 47 €



**Escurrepasta redondo**  
Cod: 8153-000  
Acabado: A. Inox  
Precio: 39 €

## Big Bowl | Gama Inset 18/10

### 60 cm

TOTALES: 550 x 500 (radio soft: 135)  
ENCASTRE: 530 x 480  
CUBETA: 450 x 400 x 185

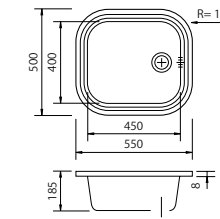

### 60 cm

TOTALES: 860 x 500 (radio soft: 135)  
ENCASTRE: 840 x 480  
CUBETA: 450 x 400 x 185

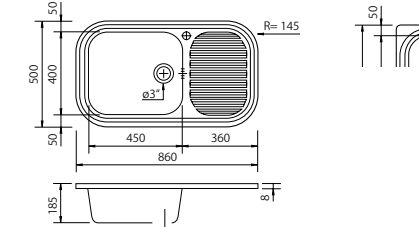

### 80 cm

TOTALES: 860 x 500 (radio soft: 135)  
ENCASTRE: 840 x 480  
CUBETA GRANDE: 450 x 400 x 185  
CUBETA PEQUEÑA: 275 x 400 x 185

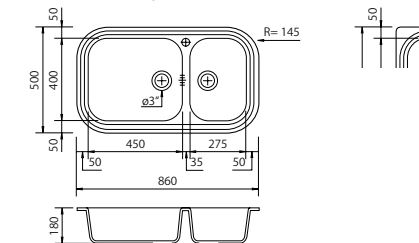

### 80 cm

TOTALES: 1160 x 500  
ENCASTRE: 1140 x 480  
CUBETA GRANDE: 450 x 400 x 185  
CUBETA PEQUEÑA: 275 x 400 x 185

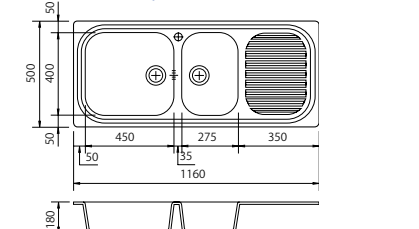

#### Grifería recomendada



**Vals extraíble**  
Cod: 9315-21  
Acabado: Cromo  
Precio: 330 €  
Ver pág: 179



### DY 11



CÓDIGO	ESCURRIDOR	ACABADO	UNIDADES	PRECIO
1961-062	Derecha	A. Inox 18/10	1	130 €
1961-762	Derecha	A. Grafit	1	150 €
1961-061	Izquierda	A. Inox 18/10	1	130 €
1961-761	Izquierda	A. Grafit	1	150 €



**45 cm**  
 TOTALES: 860 x 500  
 ENCASTRE: 840 x 480  
 CUBETA: 360 x 400 x 170

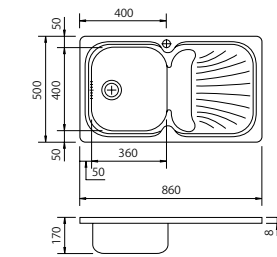

### DY 15



CÓDIGO	ESCURRIDOR	ACABADO	UNIDADES	PRECIO
1963-062	Derecha	A. Inox 18/10	1	225 €
1963-762	Derecha	A. Grafit	1	270 €
1963-061	Izquierda	A. Inox 18/10	1	225 €
1963-761	Izquierda	A. Grafit	1	270 €



**60 cm**  
 TOTALES: 970 x 500  
 ENCASTRE: 950 x 480  
 CUBETA GRANDE: 360 x 400 x 180  
 CUBETA PEQUEÑA: 150 x 300 x 150

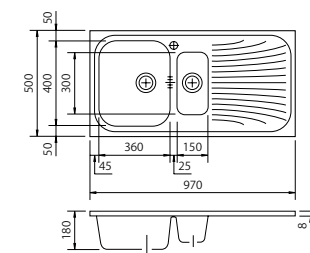

### DY 20



CÓDIGO	ACABADO	UNIDADES	PRECIO
1962/060	A. Inox 18/10	1	165 €
1962/760	A. Grafit	1	190 €



**80 cm**  
 TOTALES: 860 x 500  
 ENCASTRE: 840 x 480  
 CUBETAS: 360 x 400 x 175

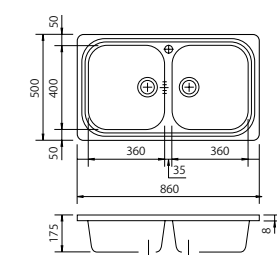

### DY 21



CÓDIGO	ESCURRIDOR	ACABADO	UNIDADES	PRECIO
1912-062	Derecha	A. Inox 18/10	1	190 €
1912-762	Derecha	A. Grafit	1	225 €
1912-061	Izquierda	A. Inox 18/10	1	190 €
1912-761	Izquierda	A. Grafit	1	225 €



**80 cm**  
 TOTALES: 1160 x 500  
 ENCASTRE: 1140 x 480  
 CUBETAS: 360 x 400 x 175

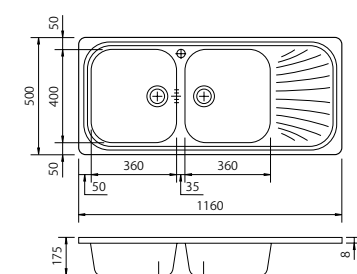

#### Complementos

**Valvula automática**  
 Cod: 8407-100  
 Acabado: A. Inox  
 Precio: 60 €

**Cesta vajilla**  
 Cod: 8611-000  
 Medidas: 34 x 40  
 Acabado: A. Inox  
 Precio: 80 €

**Cubetilla perforada**  
 Cod: 8101-000  
 Acabado: A. Inox  
 Precio: 51 €

**Soporte escurrerasta**  
 Cod: 9525-40  
 Acabado: A. Inox.  
 Precio: 47 €

**Tabla de corte Haya**  
 Cod: 8654-000  
 Medidas: 36 x 40  
 Acabado: Madera  
 Precio: 70 €  
**Escurrerasta redondo**  
 Cod: 8153-000  
 Acabado: A. Inox  
 Precio: 39 €

#### Grifería recomendada

**Fauna**  
 Cod: 2400-31  
 Acabado: Inox  
 Precio: 300 €  
 Ver pág: 178



# Angulares

## Gama Inset 18/10



### ANG 20



CÓDIGO	ACABADO	UNIDADES	PRECIO
3301-060	A. Inox 18/10	1	360 €

· Sifón incluido.

### ANG 15



CÓDIGO	ACABADO	UNIDADES	PRECIO
3305-060	A. Inox 18/10	1	425 €

· Sifón incluido  
· Siempre con orificio grifo

### ANG 21



CÓDIGO	ACABADO	UNIDADES	PRECIO
3308-060	A. Inox 18/10	1	395 €

· Sifón incluido  
· Siempre con orificio grifo

#### Complementos

**Valvula automática**  
Cod: 8407-100  
Acabado: A. Inox  
Precio: 60 €

**Cesta vajilla**  
Acabado: A. Inox  
Cod/Medidas/Precio:  
8611-000/34 x 40/60 €  
8612-000/40 x 40/60 €

**Soporte escurrepasta**  
Cod: 9525-40  
Acabado: A. Inox.  
Precio: 47 €

**Cubeta perforada**  
Cod: 8151/100  
Acabado: Blanco  
Precio: 35 €

**Tabla de corte Haya**  
Acabado: Madera  
Cod/Medidas/Precio:  
8647/34 x 40/75 €  
8655/45 x 40/80 €

**Escurrepasta redondo**  
Cod: 8153-000  
Acabado: A. Inox  
Precio: 39 €

**Cubetilla perforada**  
Cod: 8101/000  
Acabado: A. Inox  
Precio: 51 €

**Tabla deslizante**  
Cod: 8643-000  
Medidas: 30 x 54  
Acabado: Madera  
Precio: 95 €

#### Grifería recomendada

**Giratutto**  
Cod: 28900-21  
Acabado: Cromo brillo  
Precio: 420 €  
Ver pág: 174

## Angulares | Gama Inset 18/10

### R 90 x 90 cm

TOTALES: 830 x 830  
ENCASTRE: Según plantilla  
CUBETAS: 400x340x185

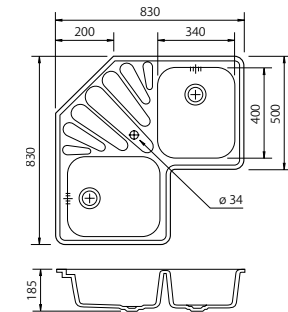

### R 90 x 90 cm

TOTALES: 830 x 830  
ENCASTRE: Según plantilla  
CUBETA GRANDE: 450 x 400 x 180  
CUBETA PEQUEÑA: 150 x 300 x 150

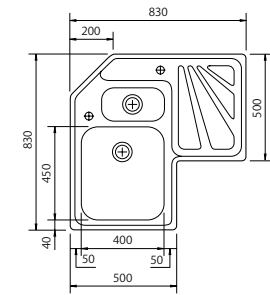

### R 90 x 90 cm

TOTALES: 830 x 830  
ENCASTRE: Según plantilla  
CUBETA GRANDE: 340 x 400 x 180  
CUBETA PEQUEÑA: 275 x 400 x 180

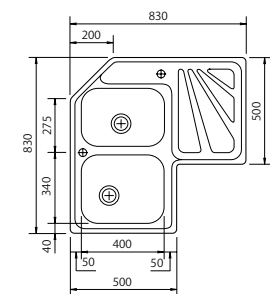



■ Magic 12 Diamante



CÓDIGO	ACABADO	UNIDADES	PRECIO
101119	A. Inox 18/10	1	595 €

- Válvula automática y Sifón incluido.
- Accesorios opcionales: Cubetilla perforada (40000043).

Magic | Gama Inset 18/10

70 cm

TOTALES: 980 x 500  
 ENCASTRE: Según plantilla  
 CUBETA GRANDE: 320 x 420 x 180  
 CUBETA PEQUEÑA: 297 x 186,5 x 117

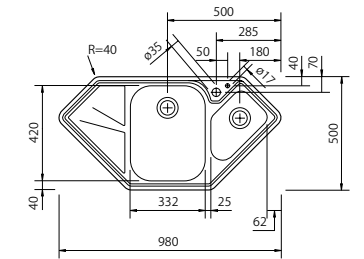

■ Magic 16 Box



CÓDIGO	ESCURRIDOR	ACABADO	UNIDADES	PRECIO
1528-262	Derecha	A. Inox 18/10	1	505 €
1528-261	Izquierda	A. Inox 18/10	1	505 €

- Sifón y cubo basura incluidos.
- Accesorios opcionales: Válvula automática (8407-100) y Cubetilla perforada (8101-100).

90 cm

TOTALES: 860 x 500  
 ENCASTRE: 840 x 480  
 CUBETA GRANDE: 330 x 400 x 190  
 CUBETA PEQUEÑA: 150 x 300 x 150

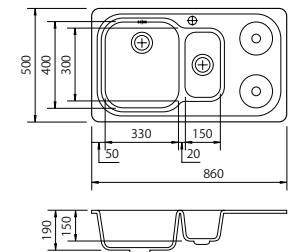

■ Magic 16 Recto



CÓDIGO	CUBETILLA	ACABADO	UNIDADES	PRECIO
26901-02	Derecha	A. Inox 18/10	1	135 €
26901-01	Izquierda	A. Inox 18/10	1	135 €

- Accesorios opcionales: Válvula automática (8407-100), cesta vajilla (8611-000), Cesta vajilla (40000-006) y cubeta perforada (100060001).

NOVEDAD 60 cm

TOTALES: 620 x 500  
 ENCASTRE: 600 x 480  
 CUBETA GRANDE: 340 x 400 x 180  
 CUBETA PEQUEÑA: 165 x 290 x 120

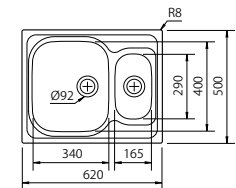

Complementos

- Válvula automática  
Cod: 8407-100  
Acabado: A. Inox  
Precio: 60 €
- Cesta Vajilla  
Cod: 8611-000  
Medidas: 34 x 40  
Acabado: A. Inox  
Precio: 60 €
- Cesta Vajilla  
Cod: 40000006  
Acabado: A. Inox  
Precio: 68 €

- Cubeta perforada  
Cod: 60001  
Acabado: A. Inox  
Precio: 45 €
- Soporte escurrepasta  
Cod: 9525-40  
Acabado: A. Inox.  
Precio: 47 €
- Tabla corte PEHD  
Cod: 8657-528  
Acabado: Blanco  
Precio: 42 €

- Cubetilla perforada  
Cod: 8101-000  
Acabado: A. Inox  
Precio: 51 €
- Escurrepasta redondo  
Cod: 8153-000  
Acabado: A. Inox  
Precio: 39 €
- Cubetilla perforada  
Cod: 40000043  
Acabado: A. Inox  
Precio: 75 €

Grifería recomendada

- Swing  
Cod: 60501-21  
Acabado: Cromo brillo  
Precio: 495 €  
Ver pág: 168

# Rondo

## Gama Inset 18/10



### Rondo | Gama Inset 18/10

#### RO 50



CÓDIGO	ACABADO	UNIDADES	PRECIO
1052-060	A. Inox 18/10	1	110 €
1052-060/3	A. Inox 18/10	3	105 €

50 cm

TOTALES: Ø520  
ENCASTRE: Ø500  
CUBETA: 460 x 180

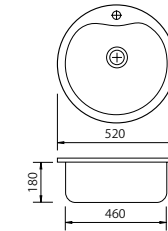

#### RO 45



CÓDIGO	ACABADO	UNIDADES	PRECIO
1015-1	A. Inox 18/10	1	90 €
1015-3	A. Inox 18/10	3	85 €



NOVEDAD

45 cm

TOTALES: Ø510  
ENCASTRE: Ø494  
CUBETA: 400 x 180

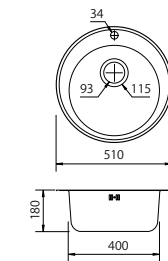

#### RO 10



CÓDIGO	ACABADO	UNIDADES	PRECIO
1010-060	A. Inox 18/10	1	85 €
1010-060/5	A. Inox 18/10	5	80 €



45 cm

TOTALES: Ø440  
ENCASTRE: Ø420  
CUBETA: 380 x 170

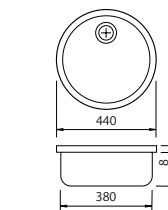

#### Complementos



Tabla de corte Haya  
Cod: 8648-000  
Acabado: Madera  
Precio: 78 €



Tabla de corte Haya  
Circular para RO-10  
Cod: 8651-000  
Acabado: Madera  
Precio: 65 €



Cesta vajilla circular  
Cod: 8601-000  
Acabado: Blanca  
Precio: 34 €



Soporte para  
cubetilla redonda  
perforada  
Cod: 8610-000  
Acabado: A. Inox  
Precio: 71 €



Escurrepasta  
redondo  
Cod: 8153-000  
Acabado: A. Inox  
Precio: 39 €



Soporte Escurreverd.  
Cod: 2538-000  
Acabado: A. Inox  
Precio: 50 €

#### Grifería recomendada



Pure Line  
Cod: 7000-21  
Acabado: Cromo brillo  
Precio: 290 €  
Ver pág: 180

## Serie 4000

### GP 11



CÓDIGO	ESCURRIDOR	ACABADO	UNIDADES	PRECIO
4611-02	Derecha	A. Inox 18/10	1	190 €
4611-01	Izquierda	A. Inox 18/10	1	190 €

### GP 15



CÓDIGO	ESCURRIDOR	ACABADO	UNIDADES	PRECIO
4615-02	Derecha	A. Inox 18/10	1	265 €
4615-01	Izquierda	A. Inox 18/10	1	265 €

### GP 20



CÓDIGO	ACABADO	UNIDADES	PRECIO
4620-2	A. Inox 18/10	1	250 €



## Gama Inset 18/10

### NOVEDAD 45 cm

TOTALES: 860 x 500  
ENCASTRE: 840 x 480  
CUBETA: 340 x 400 x 210

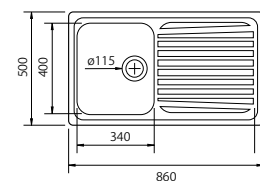

### NOVEDAD 60 cm

TOTALES: 1000 x 500  
ENCASTRE: 950 x 480  
CUBETA GRANDE: 340 x 400 x 210  
CUBETA PEQUEÑA: 165 x 300 x 130

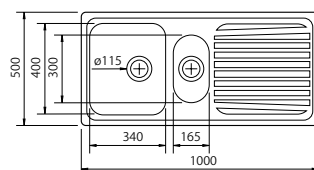

### NOVEDAD 80 cm

TOTALES: 860 x 500  
ENCASTRE: 840 x 480  
CUBETA: 340 x 400 x 210

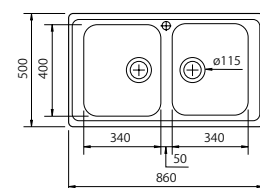

## Serie 3000

### Space 11



CÓDIGO	ESCURRIDOR	ACABADO	UNIDADES	PRECIO
25401-02	Derecha	A. Inox 18/10	1	140 €
25401-01	Izquierda	A. Inox 18/10	1	140 €

### Space 15



CÓDIGO	ESCURRIDOR	ACABADO	UNIDADES	PRECIO
73801-02	Derecha	A. Inox 18/10	1	180 €
73801-01	Izquierda	A. Inox 18/10	1	180 €

### Space 20



CÓDIGO	ACABADO	UNIDADES	PRECIO
73901	A. Inox 18/10	1	190 €

## Gama Inset 18/10

### NOVEDAD 45 cm

TOTALES: 800 x 480  
ENCASTRE: 780 x 460 (R=50)  
CUBETA: 340 x 400 x 180

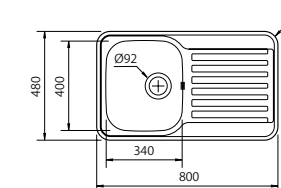

### NOVEDAD 60 cm

TOTALES: 960 x 480  
ENCASTRE: 940 x 460 (R=50)  
CUBETA GRANDE: 340 x 400 x 180  
CUBETA PEQUEÑA: 165 x 290 x 120

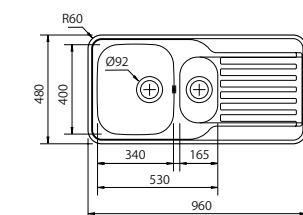

### NOVEDAD 80 cm

TOTALES: 800 x 480  
ENCASTRE: 780 x 460 (R=50)  
CUBETA GRANDE: 340 x 400 x 180  
CUBETA PEQUEÑA: 365 x 335 x 150

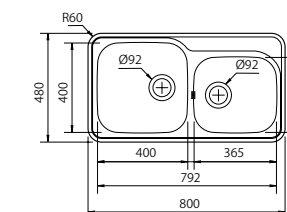

#### Complementos



**Cesta Vajilla**  
Cod: 8611-000  
Acabado: A. Inox  
Precio: 60 €



**Soporte escurrepasta**  
Cod: 6525-40  
Acabado: A. Inox.  
Precio: 47 €



**Escurrepasta redondo**  
Cod: 8153-000  
Acabado: A. Inox  
Precio: 39 €



**Cesta Vajilla**  
Cod: 40000-006  
Acabado: A. Inox  
Precio: 68 €



**Set**  
Cod: 0017  
Acabado: Madera, Blanco y A. Inox  
Precio: 175 €



**Cubeta perforada**  
Cod: 0018  
Acabado: A. Inox  
Precio: 60 €



**Mosi**  
Cod: 7104-21  
Acabado: Cromo brillo  
Precio: 270 €  
Ver pág: 173

#### Complementos



**Cubeta perforada**  
Cod: 60001  
Acabado: A. Inox  
Precio: 45 €



**Cesta Vajilla**  
Cod: 40000-006  
Acabado: A. Inox  
Precio: 68 €



**Cesta Vajilla**  
Cod: 04201  
Medidas: 34 x 40  
Acabado: A. Inox  
Precio: 60 €



**Escurrepasta redondo**  
Cod: 8153-000  
Acabado: A. Inox  
Precio: 39 €



**Soporte escurrepasta**  
Cod: 9525-40  
Acabado: A. Inox.  
Precio: 47 €



**Handicap**  
Cod: 28101-21  
Acabado: Cromo brillo  
Precio: 385 €  
Ver pág: 175

## Serie 2000

### Win 11



CÓDIGO	ESCURRIDOR	ACABADO	UNIDADES	PRECIO
1179-02	Derecha	A. Inox 18/10	1	125 €
1179-02/3	Derecha	A. Inox 18/10	3	120 €
1179-01	Izquierda	A. Inox 18/10	1	125 €
1179-01/3	Izquierda	A. Inox 18/10	3	120 €

## Gama Inset 18/10

45 cm

TOTALES: 790 x 500  
ENCASTRE: 770 x 480  
CUBETA: 340 x 400 x 170

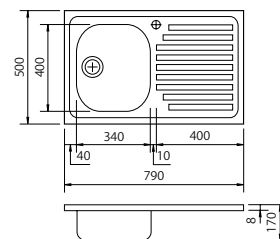

## Serie 1000

### Mile 11



CÓDIGO	ESCURRIDOR	ACABADO	UNIDADES	PRECIO
79301-21	Derecha	A. Inox 18/10	1	110 €
79301-23	Derecha	A. Inox 18/10	3	105 €
79301-11	Izquierda	A. Inox 18/10	1	110 €
79301-13	Izquierda	A. Inox 18/10	3	105 €

## Gama Inset 18/10

NOVEDAD 45 cm

TOTALES: 790 x 500  
ENCASTRE: 770 x 480  
CUBETA: 340 x 400 x 180

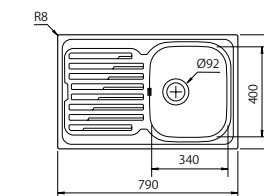

### Win 20



CÓDIGO	ACABADO	UNIDADES	PRECIO
1279-00	A. Inox 18/10	1	145 €
1279/3	A. Inox 18/10	3	140 €

80 cm

TOTALES: 790 x 500  
ENCASTRE: 770 x 480  
CUBETAS: 360 x 400 x 170

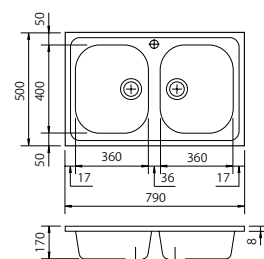

### Mile 20



CÓDIGO	ACABADO	UNIDADES	PRECIO
79401-1	A. Inox 18/10	1	135 €
79401-3	A. Inox 18/10	3	130 €

NOVEDAD 80 cm

TOTALES: 790 x 500  
ENCASTRE: 770 x 480  
CUBETA: 340 x 400 x 180

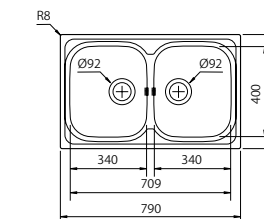

#### Complementos



**Soposte escurrepasta**  
Cod: 9525-40  
Acabado: A. Inox.  
Precio: 47 €



**Cesta Vajilla**  
Cod: 8611-000  
Medidas: 34 x 40  
Acabado: A. Inox.  
Precio: 60 €



**Tabla deslizante**  
Cod: 8654-000  
Medidas: 36 x 40  
Acabado: Madera  
Precio: 95 €



**Sempre**  
Cod: 4320-21  
Acabado: Cromo  
Precio: 100 €  
Ver pág: 182



**Escurrepasta redondo**  
Cod: 8153-000  
Acabado: A. Inox  
Precio: 39 €



**Cesta Vajilla**  
Cod: 40000-006  
Acabado: A. Inox  
Precio: 68 €



#### Complementos



**Cesta Vajilla**  
Cod: 04201  
Medidas: 34 x 40  
Acabado: A. Inox  
Precio: 60 €



**Soposte escurrepasta**  
Cod: 9525-40  
Acabado: A. Inox.  
Precio: 47 €



**Escurrepasta redondo**  
Cod: 8153-000  
Acabado: A. Inox  
Precio: 39 €



**Nuba**  
Cod: 7103-21  
Acabado: Cromo brillo  
Precio: 190 €  
Ver pág: 173