

TARIFA CATÁLOGO

DICIEMBRE 2006







Artesana INSET

Acero Inoxidable AISI 304 18/10

Proceso Manual

Pulido Alto Brillo Manual.

Espesor de chapa 1mm.

Producto	Modelo	Código	Referencia	Dimensión	Precio €
	32801	332801	05/282808/15	450x500 total 400x400x200 cubeta	488,00
	Mueble 45 cm.				
	32802	332802	25/301252/15	600x500 total 550x400x200 cubeta	519,00
Mueble 60 cm.					
	32803	332803	05/331992/17	800x500 total 740x400x200 cubeta	572,00
	Mueble 80 cm.				

- Todos los fregaderos incluyen válvulas de 3^{1/2}" con sifón incluido.
- Accesorios de instalación.

- Plantillas de corte e instrucciones de montaje.
- Embalaje en caja de cartón unitaria.





Artesana (Bajo Encimera)

Acero Inoxidable AISI 304 18/10

Proceso Manual. Pulido Alto Brillo Manual.

Espesor de chapa 1mm.

Producto	Modelo	Código	Referencia	Dimensión	Precio €
	34008	334008	05/319696/17	900x500 total 400x400x200 cubeta	551,00
	Mueble 45 cm.				
	34009	334009	05/350436/17	1000x500 total 450x400x200 cubeta	604,00
	Mueble 50 cm.				

- Todos los fregaderos incluyen válvulas de 3^{1/2}" con sifón incluido.
- Accesorios de instalación.

- Plantillas de corte e instrucciones de montaje.
- Embalaje en caja de cartón unitaria.





Artesana Flat

Posibilidad de instalación **Encastrado** o **Integrado**, ala 20mm. de superficie de planitud perfecta.

Acero Inoxidable AISI 304 18/10 **Proceso Manual.**

Pulido Alto Brillo Manual. Espesor de chapa 1mm.

Producto	Modelo	Código	Referencia	Dimensión	Precio €
	33008	333008	05/338140/17	900x500 total 400x400x200 cubeta	583,00
	Mueble 45 cm.				
	33009	333009	05/368880/17	1000x500 total 450x400x200 cubeta	636,00
	Mueble 50 cm.				

- Todos los fregaderos incluyen válvulas de 3^{1/2}" con sifón incluido.
- Tubo de silicona incluido.

- Plantillas de corte e instrucciones de montaje.
- Embalaje en caja de cartón unitaria.

Artesana (Bajo Encimera)

Acero Inoxidable AISI 304 18/10

Proceso Manual

Pulido Alto Brillo Manual.

Espesor de chapa 1mm.

**FREGADEROS
ACERO PULIDO**

Producto	Modelo	Código	Referencia	Dimensión	P.V. €
	34051	334051	05/224402/15	200x360 total 160x320x140 cubeta sifón incluido	387,00
Mueble 30 cm					
	34052	334052	05/258216/15	320x440 total 280x400x180 cubeta sifón incluido	445,00
Mueble 40 cm					
	34053	334053	05/261290/15	380x440 total 340x400x200 cubeta sifón incluido	451,00
Mueble 45 cm					
	34054	334054	05/267438/15	440x440 total 400x400x200 cubeta sifón incluido	461,00
Mueble 50 cm					
	34055	334055	05/276660/15	440x490 total 400x450x200 cubeta sifón incluido	477,00
Mueble 60 cm					
	34056	334056	05/279734/15	490x490 total 450x450x200 cubeta sifón incluido	482,00
Mueble 60 cm					

- Todos los fregaderos incluyen válvulas de 3/12", con **sifón incluido**.
- Accesorios de instalación.
- Plantillas de corte e instrucciones de montaje.
- Embalaje en caja de cartón unitaria.

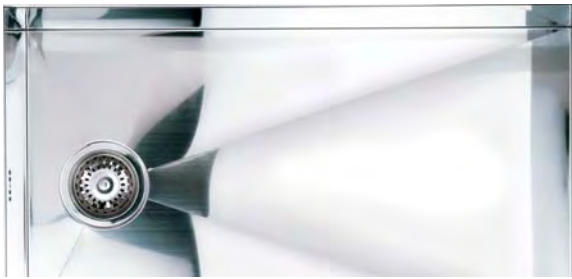

Artesana (Bajo Encimera)

Acero Inoxidable AISI 304 18/10

Proceso Manual

Pulido Alto Brillo Manual.

Espesor de chapa 1mm.

Producto	Modelo	Código	Referencia	Dimensión	P.V. €
	34057	334057	05/285882/15	590x460 total 550x420x200 cubeta sifón incluido	493,00
Mueble 70 cm					
	34058	334058	05/307400/15	780x460 total 740x420x200 cubeta sifón incluido	530,00
Mueble 80 cm					
	34007	334007	05/225017/17	540x440x20 total 500x400 cubeta sifón incluido	388,00
Escurreidor					





Artesana (Bajo Encimera)

Acero Inoxidable AISI 304 18/10

Proceso Industrial

Pulido Alto Brillo Uniforme

Espesor de chapa 1mm.

	34074	334074	05/202884/15	440x440 total 400x400x200 cubeta sifón incluido	350,00
Mueble 50 cm					
	34078	334078	05/264364/15	760x440 total 720x400x200 cubeta sifón incluido	456,00
Mueble 80 cm					

- Todos los fregaderos incluyen válvulas de 3/2", con **sifón incluido**
- Accesorios de instalación.
- Plantillas de corte e instrucciones de montaje.
- Embalaje en caja de cartón unitaria.

Bajo Encimera

Acero Inoxidable AISI 304 18/10
Pulido Brillo Alta Resistencia.
Espesor de chapa 1mm.



Producto	Modelo	Código	Referencia	Dimensión	P.V. €
	31251	331251	05/42502/15	175x325 total 147x297x150 cubeta	73,00
Mueble 30 cm					
	31252	331252	05/49808/15	338x378 total 300x340x200 cubeta	86,00
Mueble 40 cm					
	31253	331253	05/51800/15	378x438 total 340x400x200 cubeta	89,00
Mueble 45 cm					
	31254	331254	05/73715/15	440x440 total 400x400x200 cubeta	127,00
Mueble 50 cm					
	31255	331255	05/79692/15	487x438 total 450x400x200 cubeta	137,00
Mueble 60 cm					
	31256	331256	05/94302/15	490x490 total 450x450x200 cubeta	163,00
Mueble 60 cm					

- Todos los fregaderos incluyen válvulas de 3/12"
- Accesorios de instalación.
- Plantillas de corte e instrucciones de montaje.
- Embalaje en caja de cartón unitaria.



Bajo Encimera

Acero Inoxidable AISI 304 18/10

Pulido Brillo Alta Resistencia.

Espesor de chapa 1mm.

Producto	Modelo	Código	Referencia	Dimensión	P.V. €
	31257	331257	05/98951/15	540x440 total 500x400x200 cubeta	171,00
Mueble 60 cm.					
	31155	331155	22/58441/15	∅ 460 total ∅ 400x180 cubeta	101,00
Mueble 50 cm.					
	31258	331258	05/101607/23	580x460 total 540x410 encastre 340x400x210 cubeta 165x300x130 cubeta	175,00
Mueble 60 cm.					
	31259	331259	05/134148/16	760x450 total 718x410 encastre 340x400x210 cubeta 340x400x210 cubeta	231,00
Mueble 80 cm.					
	31260	331260	05/141453/16	830x450 total 788x410 encastre 450x400x210 cubeta 300x400x210 cubeta	244,00
Mueble 90 cm.					

- Todos los fregaderos incluyen válvulas de 3/12"
- Accesorios de instalación.
- Plantillas de corte e instrucciones de montaje.
- Embalaje en caja de cartón unitaria.



Artesana (Flat)

Posibilidad de instalación **Encastrado o Integrado**,
ala 20mm. de superficie de planitud perfecta.

Acero Inoxidable AISI 304 18/10

Proceso Manual

Pulido Alto Brillo Manual.

Espesor de chapa 1mm.

**FREGADEROS
ACERO PULIDO**

Producto	Modelo	Código	Referencia	Dimensión	P.V. €
	33051	333051	05/242846/15	200x360 total 160x320x140 cubeta	419,00
Mueble 30 cm				sifón incluido	
	33052	333052	05/276660/15	320x440 total 280x400x180 cubeta	477,00
Mueble 40 cm				sifón incluido	
	33053	333053	05/279734/15	380x440 total 340x400x200 cubeta	482,00
Mueble 45 cm				sifón incluido	
	33054	333054	05/285882/15	440x440 total 400x400x200 cubeta	493,00
Mueble 50 cm				sifón incluido	
	33055	333055	05/295104/15	440x490 total 400x450x200 cubeta	509,00
Mueble 60 cm				sifón incluido	
	33056	333056	05/298178/15	490x490 total 450x450x200 cubeta	514,00
Mueble 60 cm				sifón incluido	

- Todos los fregaderos incluyen válvulas de 3/12", con **sifón incluido**.
- Tubo de silicona incluido.
- Plantillas de corte e instrucciones de montaje.
- Embalaje en caja de cartón unitaria.



Artesana (Flat)

Posibilidad de instalación **Encastrado o Integrado**,
ala 20mm. de superficie de planitud perfecta.

Acero Inoxidable AISI 304 18/10

Proceso Manual

Pulido Alto Brillo Manual.

Espesor de chapa 1mm.

Producto	Modelo	Código	Referencia	Dimensión	P.V. €
	33057	333057	05/304326/15	590x460 total 550x420x200 cubeta	525,00
Mueble 70 cm				sifón incluido	
	33058	333058	22/325844/15	780x460 total 740x420x200 cubeta	562,00
Mueble 80 cm				sifón incluido	
	33007	333007	05/242231/17	540x440x20 total 500x400 cubeta	418,00
Escurreidor				sifón incluido	



Artesana (Flat)



Posibilidad de instalación **Encastrado o Integrado**,
ala 20mm. de superficie de planitud perfecta.

Acero Inoxidable AISI 304 18/10

Proceso Industrial

Pulido Alto Brillo Uniforme

Espesor de chapa 1mm.

	33074	333074	05/221328/15	440x440 total 400x400x200 cubeta	382,00
Mueble 50 cm				sifón incluido	
	33078	333078	22/285882/15	760x440 total 720x400x200 cubeta	493,00
Mueble 80 cm				sifón incluido	

- Todos los fregaderos incluyen válvulas de 3^{1/2"}, con **sifón incluido**
- Tubo de silicona incluido.
- Plantillas de corte e instrucciones de montaje.
- Embalaje en caja de cartón unitaria.



Flat

Posibilidad de instalación **ENCASTRADO** o **INTEGRADO**,
 ala 20 mm. de superficie de planitud perfecta.
 Acero Inoxidable AISI 304 18/10
 Pulido Brillo Alta Resistencia.
 Espesor de chapa 1mm.

**FREGADEROS
 ACERO PULIDO**

Producto	Modelo	Código	Referencia	Dimensión	P.V. €
	32951	332951	05/45823/15	175x325 total 147x297x150 cubeta	79,00
Mueble 30 cm					
	32952	332952	05/54456/15	338x378 total 300x340x200 cubeta	94,00
Mueble 40 cm					
	32953	332953	05/56449/15	378x438 total 340x400x200 cubeta	97,00
Mueble 45 cm					
	32954	332954	05/80356/15	440x440 total 400x400x200 cubeta	139,00
Mueble 50 cm					
	32955	332955	05/86333/15	487x438 total 450x400x200 cubeta	149,00
Mueble 60 cm					
	32956	332956	05/102277/15	490x490 total 450x450x200 cubeta	176,00
Mueble 60 cm					

- Todos los fregaderos incluyen válvulas de 3^{1/2}"
- Tubo de silicona incluido.
- Plantillas de corte e instrucciones de montaje.
- Embalaje en caja de cartón unitaria.

Flat

Posibilidad de instalación **ENCASTRADO** o **INTEGRADO**,
ala 20 mm. de superficie de planitud perfecta.

Acero Inoxidable AISI 304 18/10

Pulido Brillo Alta Resistencia.

Espesor de chapa 1mm.



Producto	Modelo	Código	Referencia	Dimensión	P.V. €
	32957	332957	05/107584/15	540x440 total 500x400x200 cubeta	185,00
Mueble 60 cm.					
	31955	331955	05/63754/15	ø 460 total ø 400x180 cubeta	110,00
Mueble 50 cm.					
	32958	332958	05/110905/23	580x460 total 570x448 encastre 340x420x210 cubeta 165x300x130 cubeta	191,00
Mueble 60 cm.					
	32959	332959	05/146102/16	760x450 total 749x438 encastre 340x400x210 cubeta 340x400x210 cubeta	252,00
Mueble 80 cm.					
	32960	332960	05/154071/16	830x450 total 819x438 encastre 450x400x210 cubeta 300x400x210 cubeta	266,00
Mueble 90 cm.					

- Todos los fregaderos incluyen válvulas de 3/12"
- Tubo de silicona incluido.
- Plantillas de corte e instrucciones de montaje.
- Embalaje en caja de cartón unitaria.



Sima

Acero Inoxidable AISI 304 18/10
Fregaderos con cubetas de gran profundidad 210mm.
 Válvula Automática
 Pulido Alto Brillo.

**FREGADEROS
 ACERO PULIDO**

Producto	Modelo	Código	Referencia	Dimensión	P.V. €
	1517*	31517	05/111085/17	860x500 total 840x480 encastre 340x400x210 cubeta sifón incluido	192,00
Mueble 45cm.					
	1524*	31524	05/162197/24	1000x500 total 950x480 encastre 340x400x210 cubeta 165x300x130 cubeta sifón incluido	280,00
Mueble 60cm.					
	1516	31516	05/147204/16	860x500 total 840x480 encastre 340x400x210 cubeta 340x400x210 cubeta sifón incluido	254,00
Mueble 80cm.					
	1519*	31519	05/172420/19	1160x500 total 1140x480 encastre 340x400x210 cubeta 340x400x210 cubeta sifón incluido	297,00
Mueble 80cm.					

Sima, los fregaderos con las cubetas más profundas del mercado, 21 cm.

- *Fregadero reversible.
- Fregaderos con orificio de grifo.
- Todos los fregaderos incluyen válvula Automática de 3^{er} con sifón, grapas de sujeción y junta de estanqueidad.
- Refuerzo de grifería metálico incluido.
- Embalaje en caja de cartón unitaria.



Abyss

Acero Inoxidable AISI 304 18/10
Fregaderos con cubetas de gran profundidad 210mm.
 Pulido Alto Brillo.

Producto	Modelo	Código	Referencia	Dimensión	P.V. €
	3117*	33117	05/90640/17	860x500 total 840x480 encastre 340x400x210 cubeta	156,00
Mueble 45 cm.					
	3124*	33124	05/128804/24	1000x500 total 950x480 encastre 340x400x210 cubeta 165x300x130 cubeta	222,00
Mueble 60 cm.					
	3116	33116	05/111766/16	860x500 total 840x480 encastre 340x400x210 cubeta 340x400x210 cubeta	193,00
Mueble 80 cm.					
	3119*	33119	05/137663/19	1160x500 total 1140x480 encastre 340x400x210 cubeta 340x400x210 cubeta	237,00
Mueble 80 cm.					

Abyss, los fregaderos con las cubetas más profundas del mercado, 21 cm.

- *Fregadero reversible.
- Todos los fregaderos incluyen válvulas de 3/12", grapas de sujeción y junta de estanqueidad.
- Refuerzo de grifería metálico incluido.
- Embalaje en caja de cartón unitaria.



Abyss





Acero Inoxidable AISI 304 18/10
Fregaderos con cubetas de gran profundidad 210mm.
 Pulido Alto Brillo.

**FREGADEROS
 ACERO PULIDO**

Producto	Modelo	Código	Referencia	Dimensión	P.V. €
 	3126	33126	05/249429/26	830x830x500 total 596x596x480 encastre 340x400x210 cubeta 165x300x130 cubeta 340x400x210 cubeta sifón incluido	430,00
	Mueble 90x90 cm.				
	3127	33127	05/166286/27	830x830x500 total 596x596x480 encastre 340x400x210 cubeta 340x400x210 cubeta sifón incluido	287,00
	Mueble 90x90 cm.				

Abyss, los fregaderos con las cubetas más profundas del mercado, 21 cm.

- *Fregadero reversible.
- Todos los fregaderos incluyen válvulas de 3/12", grapas de sujeción y junta de estanqueidad.
- Refuerzo de grifería metálico incluido.
- Embalaje en caja de cartón unitaria.

Producto	Modelo	Código	Referencia	Dimensión	P.V. €
	3215.1*	33215.1	10/103023/23	600x500 total 575x485 encastre 340x370x160 cubeta 150x310x120 cubeta	178,00
Mueble 60cm.					
	3217.1*	33217.1	10/112259/24	800x500 total 776x486 encastre 340x370x160 cubeta 150x310x120 cubeta	194,00
Mueble 60cm.					
	3217/100*	33217/100	28/119364/24	1000x500 total 980x480 encastre 340x370x160 cubeta 150x310x120 cubeta	206,00
Mueble 60cm.					
	3619*	33619	25/131492/25	1200x510 total 1176x486 encastre 400x400x160 cubeta 300x300x160 cubeta	227,00
Mueble 80cm.					
	3615	33615	10/229779/15	860x500 total 800x474 encastre 760x420x217 cubeta	396,00
Mueble 80cm.					

Bandeja escurreplatos, cubeta de plástico con tapón y tabla de polietileno
INCLUIDOS EN EL PRECIO

- *Fregadero reversible.
- Todos los fregaderos incluyen válvulas de 3^{1/2}" , grapas de sujeción y cinta de estanqueidad.
- Embalaje en caja de cartón unitaria.

Producto	Modelo	Código	Referencia	Dimensión	P.V. €
	1415	31415	05/46702/15	Ø 460 total Ø 440 encastre Ø 400x180 cubeta	81,00
Mueble 45 cm.					
	1415.6	31415.6	10/53360/15	Ø 510 total Ø 494 encastre Ø 400x180 cubeta	92,00
Mueble 45 cm.					
	1317.2*	31317.2	14/56840/17	835x440 total 811x416 encastre Ø 380x160 cubeta	98,00
Mueble 45 cm.					
	1316	31316	11/64960/16	835x440 total 811x416 encastre Ø 365x160 cubeta Ø 365x160 cubeta	112,00
Mueble 80 cm.					
	1416	31416	17/116046/16	930x490 total 894x454 encastre Ø 390x160 cubeta Ø 390x160 cubeta	200,00
Mueble 90 cm.					

- *Fregadero reversible.
- Todos los fregaderos incluyen válvulas de 3^{1/2}", grapas de sujeción y cinta de estanqueidad.



Diseño

Acero Inoxidable AISI 304 18/10





Producto	Modelo	Código	Referencia	Dimensión	P.V. €
	3617.2*	33617.2	10/56608/17	800x450 total 778x428 encastre 340x370x160 cubeta	98,00
Mueble 45 cm.					
	3616.2	33616.2	05/64960/16	800x450 total 778x428 encastre 340x370x160 cubeta 340x370x160 cubeta	112,00
Mueble 80 cm.					

- *Fregadero reversible.
- Todos los fregaderos incluyen válvulas de 3^{1/2"}, grapas de sujeción y cinta de estanqueidad.

Clásica Plus 60

Acero Inoxidable AISI 304 18/10

FREGADEROS
ACERO PULIDO

Producto	Modelo	Código	Referencia	Dimensión	P.V. €
	3515.1	33515.1	15/46183/15	450x510 total 440x500 encastre 340x370x160 cubeta	80,00
	Mueble 45 cm.				
	Novedad/New				
	3515/60.1	33515/60.1	15/51040/15	600x510 total 590x500 encastre 500x400x160 cubeta	88,00
	Mueble 60 cm.				
	Novedad/New				
	3517.3*	33517.3	17/57420/17	800x510 total 785x495 encastre 340x400x160 cubeta	99,00
	Mueble 45 cm.				
	Novedad/New				
	3516.1	33516.1	06/67280/16	800x510 total 785x495 encastre 340x400x160 cubeta	116,00
	Mueble 80 cm.				
	Novedad/New				
	3519.4*	33519.4	23/104400/19	1200x510 total 1190x500 encastre 340x370x160 cubeta	180,00
	Mueble 80 cm.			340x370x160 cubeta	
	Novedad/New				

- Embalaje en caja de cartón unitario.
- *Fregadero reversible.
- Todos los fregaderos incluyen válvulas de 3^{1/2}", grapas de sujeción y cinta de estanqueidad.

Clásica Plus 50

Acero Inoxidable AISI 304 18/10

Producto	Modelo	Código	Referencia	Dimensión	P.V. €
	3415.1	33415.1	20/42630/15	450x435 total 440x425 encastre 340x370x160 cubeta	74,00
	Mueble 45 cm.				
	Novedad/New				
	3417.3*	33417.3	05/53288/17	800x435 total 776x411 encastre 340x370x160 cubeta	92,00
	Mueble 45 cm.				
	Novedad/New				
	3416.4	33416.4	05/65366/16	800x435 total 776x411 encastre 340x370x160 cubeta 340x370x160 cubeta	113,00
	Mueble 80 cm.				
	Novedad/New				
	3419.1*	33419.1	25/110128/19	1200x435 total 1190x425 encastre 340x370x160 cubeta 340x370x160 cubeta	190,00
	Mueble 80 cm.				
	Novedad/New				

- Embalaje en caja de cartón unitario.
- *Fregadero reversible.
- Todos los fregaderos incluyen válvulas de 3/2^o, grapas de sujeción y cinta de estanqueidad.



Clásica 60

Acero Inoxidable AISI 304 18/10

FREGADEROS
ACERO PULIDO

Producto	Modelo	Código	Referencia	Dimensión	P.V. €
	3515	33515	15/40499/15	450x510 total 440x500 encastre 340x370x160 cubeta	70,00
Mueble 45 cm.					
	3515/60	33515/60	15/47604/15	600x510 total 590x500 encastre 500x400x160 cubeta	82,00
Mueble 60 cm.					
	3517*	33517	17/54709/17	800x510 total 785x495 encastre 340x400x160 cubeta	94,00
Novedad/New					
	3516	33516	06/61480/16	800x510 total 785x495 encastre 340x400x160 cubeta 340x400x160 cubeta	106,00
Mueble 80 cm.					
Novedad/New					
	3519*	33519	23/101602/19	1200x510 total 1190x500 encastre 340x370x160 cubeta 340x370x160 cubeta	175,00
Mueble 80 cm.					

- *Fregadero reversible.
- Todos los fregaderos incluyen válvulas de 2", grapas de sujeción y cinta de estanqueidad.



Clásica 50

Acero Inoxidable AISI 304 18/10

Producto	Modelo	Código	Referencia	Dimensión	P.V. €
	3415	33415	20/37657/15	450x435 total 440x425 encastre 340x370x160 cubeta	65,00
	3417.2*	33417.2	05/49880/17	800x435 total 776x411 encastre 340x370x160 cubeta	86,00
	3416.2	33416.2	05/60900/16	800x435 total 776x411 encastre 340x370x160 cubeta 340x370x160 cubeta	105,00
	3419*	33419	25/95918/19	1200x435 total 1190x425 encastre 340x370x160 cubeta 340x370x160 cubeta	165,00

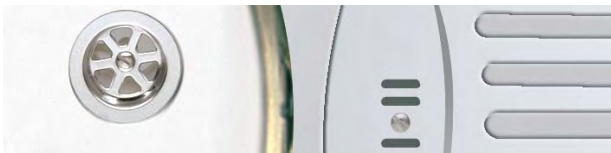

Clásica Mate

Acero Inoxidable AISI 304 18/10

Producto	Modelo	Código	Referencia	Dimensión	P.V. €
	3417.5*	33417.5	05/45240/17	800x435 total 776x411 encastre 340x370x160 cubeta	78,00
	3717.5*	33717.5	05/48314/17	780x435 total 760x415 encastre	83,00
	3717X*	33717X	05/55419/17	355x360x160 cubeta	96,00
	Texturado Mueble 50 cm.				
	3416.5	33416.5	05/48140/16	800x435 total 776x411 encastre 340x370x160 cubeta 340x370x160 cubeta	83,00
	Mueble 80 cm.				

- *Fregadero reversible.
- Todos los fregaderos incluyen válvulas de 2", grapas de sujeción y cinta de estanqueidad.

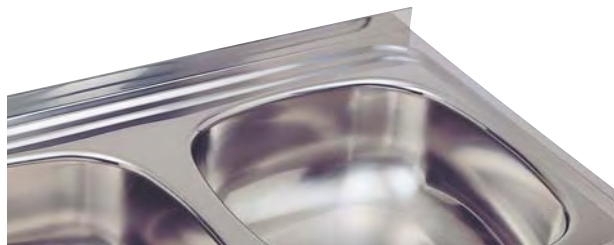

Standard

Acero Inoxidable AISI 304 18/10

FREGADEROS
ACERO PULIDO

Producto	Modelo	Código	Referencia	Dimensión	P.V. €
	4417*	34417	04/34815/15	450x450 total 340x370x160 cubeta	60,00
	2515/45	32515/45	04/35525/15	450x500 total 340x370x160 cubeta	61,00
	2515/60	32515/60	04/39078/15	600x500 total 500x400x160 cubeta	67,00
	2515/70	32515/70	02/44762/15	700x500 total 500x400x160 cubeta	77,00
	2517/80/D	32517/80	06/48314/17	800x500 total 340x370x160 cubeta	83,00
	2518/80/I	32518/80	06/48314/17		
	2517/90/D	32517/90	02/50446/17	900x500 total 400x340x160 cubeta	87,00
	2518/90/I	32518/90	02/50446/17		
	2517/100/D	32517/100	03/56840/17	1000x500 total 400x340x160 cubeta	98,00
	2518/100/I	32518/100	03/56840/17		
	2516/80	32516/80	14/63945/16	800x500 total 340x400x160 cubeta 340x400x160 cubeta	110,00
	2516/90	32516/90	09/70340/16	900x500 total 370x340x160 cubeta 370x340x160 cubeta	121,00
	2519/120/D	32519/120	15/85971/19	1200x500 total 340x370x160 cubeta 340x370x160 cubeta	148,00
	2520/120/I	32520/120	15/85971/19		

- Todos los fregaderos incluyen válvulas de 2".
- *Con orificio de grifo a la derecha.



Industrial

Acero Inoxidable AISI 304 18/10
Espesor de chapa 1'2 mm.

Producto	Modelo	Código	Referencia	Dimensión	P.V. €
	6615	46615	05/209316/15	700x600 total 550x450x300 cubeta	361,00
	6715	46715	05/231495/15	700x700 total 550x450x300 cubeta	399,00
	6617.2/D	46617.2	05/227337/17	1100x600 total 550x450x300 cubeta	392,00
	6618.2/I	46618.2	05/227337/17	550x450x300 cubeta	
	6617/D	46617	05/265457/17	1300x600 total 550x450x300 cubeta	458,00
	6618/I	46618	05/265457/17	550x450x300 cubeta	
	6717/D	46717	05/307736/17	1300x700 total 550x450x300 cubeta	531,00
	6718/I	46718	05/307736/17	550x450x300 cubeta	
	6616	46616	05/381898/16	1300x600 total 550x450x300 cubeta 550x450x300 cubeta	658,00
	6716	46716	05/440119/16	1300x700 total 550x450x300 cubeta 550x450x300 cubeta	759,00
	6619.1/D	46619.1	05/372888/19	1700x600 total 550x450x300 cubeta 550x450x300 cubeta	643,00
	6620.1/I	46620.1	05/372888/19	550x450x300 cubeta	
	6619/D	46619	05/431108/19	1900x600 total 550x450x300 cubeta 550x450x300 cubeta	743,00
	6620/I	46620	05/431108/19	550x450x300 cubeta	
	6719/D	46719	05/503884/19	1900x700 total 550x450x300 cubeta 550x450x300 cubeta	869,00
	6720/I	46720	05/503884/19	550x450x300 cubeta	
	6621	46621	05/539925/21	2600x600 total 550x450x300 cubeta 550x450x300 cubeta	931,00
	6721	46721	05/580125/21	2600x700 total 550x450x300 cubeta 550x450x300 cubeta	1.000,00
	6622	46622	05/399919/22	1900x600 total 550x450x300 cubeta	690,00
	6722	46722	05/460218/22	1900x700 total 550x450x300 cubeta	793,00



- Todos los fregaderos incluyen válvulas de 3^{1/2}" con rebosadero exterior.
- Espesor de chapa acero de 1'2 mm.
- Pulido brillo higiénico, de fácil limpieza.
- Embalaje en caja de cartón unitaria.

Sima Texturado

Acero Inoxidable AISI 304 18/10
Fregaderos con cubetas de gran profundidad 210mm.
 Válvula Automática
 Texturado

Sima, los fregaderos con las cubetas más profundas del mercado, 21 cm.

**FREGADEROS
 ACERO TEXTURADO**

Producto	Modelo	Código	Referencia	Dimensión	P.V. €
	1517X*	31517X	05/129610/17	860x500 total 840x480 encastre 340x400x210 cubeta sifón incluido	223,00
				TEXTURADO / TEXTURED Mueble 45cm.	
	1524X*	31524X	05/185751/24	1000x500 total 950x480 encastre 340x400x210 cubeta 165x300x130 cubeta sifón incluido	320,00
				TEXTURADO / TEXTURED Mueble 60cm.	
	1516X	31516X	05/169810/16	860x500 total 840x480 encastre 340x400x210 cubeta 340x400x210 cubeta sifón incluido	293,00
				TEXTURADO / TEXTURED Mueble 80cm.	
	1519X*	31519X	05/198227/19	1160x500 total 1140x480 encastre 340x400x210 cubeta 340x400x210 cubeta sifón incluido	342,00
				TEXTURADO / TEXTURED Mueble 80cm.	

- *Fregadero reversible.
- Fregaderos con orificio de grifo.
- Todos los fregaderos incluyen válvula Automática de 3^{1/2}" con sifón, grapas de sujeción y junta de estanqueidad.
- Refuerzo de grifería metálico incluido.
- Embalaje en caja de cartón unitaria.

Abyss Texturado

Acero Inoxidable AISI 304 18/10
Fregaderos con cubetas de gran profundidad 210mm.
Texturado

Abyss, los fregaderos con las cubetas más profundas del mercado, 21 cm.

Producto	Modelo	Código	Referencia	Dimensión	P.V. €
	3117X*	33117X	05/104270/17	860x500 total 840x480 encastre 340x400x210 cubeta	180,00
TEXTURADO / TEXTURED					
Mueble 45cm.					
	3124X*	33124X	05/149249/24	1000x500 total 950x480 encastre 340x400x210 cubeta 165x300x130 cubeta	257,00
TEXTURADO / TEXTURED					
Mueble 60cm.					
	3116X	33116X	05/128804/16	860x500 total 840x480 encastre 340x400x210 cubeta 340x400x210 cubeta	222,00
TEXTURADO / TEXTURED					
Mueble 80 cm.					
	3119X*	33119X	05/158790/19	1160x500 total 1140x480 encastre 340x400x210 cubeta 340x400x210 cubeta	274,00
TEXTURADO / TEXTURED					
Mueble 80 cm.					
	3126X	33126X	05/286912/26	830x830x500 total 596x596x480 encastre 340x400x210 cubeta 165x300x130 cubeta 340x400x210 cubeta	495,00
TEXTURADO / TEXTURED					
Mueble 90x90 cm.					
sifón incluido					
	3127X	33127X	05/187413/27	830x830x500 total 596x596x480 encastre 340x400x210 cubeta 340x400x210 cubeta	323,00
TEXTURADO / TEXTURED					
Mueble 90x90 cm.					
sifón incluido					

- *Fregadero reversible.
- Todos los fregaderos incluyen válvulas de 3/4", grapas de sujeción y junta de estanqueidad.
- Refuerzo de grifería metálico incluido.
- Embalaje en caja de cartón unitaria.

Astral Texturado

Acero Inoxidable AISI 304 18/10
Texturado

FREGADEROS
ACERO TEXTURADO





Producto	Modelo	Código	Referencia	Dimensión	P.V. €
	3215.1X*	33215.1X	10/118654/23	600x500 total 575x485 encastre 340x370x160 cubeta 150x310x120 cubeta	205,00
TEXTURADO / TEXTURED					
Mueble 60cm.					
	3217.1X*	33217.1X	10/130022/24	800x500 total 776x486 encastre 340x370x160 cubeta 150x310x120 cubeta	224,00
TEXTURADO / TEXTURED					
Mueble 60cm.					
	3217/100X*	33217/100X	20/138548/24	1000x500 total 980x480 encastre 340x370x160 cubeta 150x310x120 cubeta	239,00
TEXTURADO / TEXTURED					
Mueble 60cm.					
	3619X*	33619X	20/152079/25	1200x510 total 1176x486 encastre 400x400x160 cubeta 300x300x160 cubeta	262,00
TEXTURADO / TEXTURED					
Mueble 80cm.					
	3615X	33615X	10/263648/15	860x500 total 800x474 encastre 760x420x217 cubeta	455,00
TEXTURADO / TEXTURED					
Mueble 80cm.					
Bandeja escurrer platos, cubeta de plástico con tapón y tabla polietileno INCLUIDOS EN EL PRECIO					

- *Fregadero reversible.
- Todos los fregaderos incluyen válvulas de 3^{1/2}" , grapas de sujeción y cinta de estanqueidad.
- Embalaje en caja de cartón unitaria.

Diseño Texturado

Acero Inoxidable AISI 304 18/10

Texturado

Producto	Modelo	Código	Referencia	Dimensión	P.V. €
	1415.6X	31415.6X	15/59682/15	Ø 510 total Ø 494 encastre Ø 400x180 cubeta	103,00
				TEXTURADO / TEXTURED	
				Mueble 45 cm.	
	1317.2X*	31317.2X	10/64656/17	835x440 total 811x416 encastre Ø 380x160 cubeta	111,00
				TEXTURADO / TEXTURED	
				Mueble 45 cm.	
	1316X	31316X	10/72500/16	835x440 total 811x416 encastre Ø 365x160 cubeta Ø 365x160 cubeta	125,00
				TEXTURADO / TEXTURED	
				Mueble 80 cm.	
	3617.2X*	33617.2X	05/65366/17	800x450 total 778x428 encastre 340x370x160 cubeta	113,00
				TEXTURADO / TEXTURED	
				Mueble 45 cm.	
	3616.2X	33616.2X	05/74240/16	800x450 total 778x428 encastre 340x370x160 cubeta 340x370x160 cubeta	128,00
				TEXTURADO / TEXTURED	
				Mueble 80 cm.	

- *Fregadero reversible.
- Todos los fregaderos incluyen válvulas de 3^{1/2}" , grapas de sujeción y cinta de estanqueidad.

Clásica Plus 60 Texturado

Acero Inoxidable AISI 304 18/10
Texturado

FREGADEROS
ACERO TEXTURADO

Producto	Modelo	Código	Referencia	Dimensión	P.V. €
	3517.3X*	33517.3X	17/68208/17	800x510 total 785x495 encastre 340x400x160 cubeta	118,00
TEXTURADO / TEXTURED					
Mueble 45 cm.					
	3516.1X	33516.1X	06/76734/16	800x510 total 785x495 encastre 340x400x160 cubeta 340x400x160 cubeta	132,00
TEXTURADO / TEXTURED					
Mueble 80 cm.					







- *Fregadero reversible.
- Todos los fregaderos incluyen válvulas de 3^{1/2}" , grapas de sujeción y cinta de estanqueidad.
- Embalaje en caja de cartón unitario.



Lavabos

Acero Inoxidable AISI 304 18/10
Acabado pulido brillo a dos caras.
Espesor de chapa 1mm.

Producto	Modelo	Código	Referencia	Dimensión	P.V. €
SIN REBOSADERO					
	1315/30	31315/30	10/55419/15	Ext. Ø 305/Int.Ø280	96,00
	1315/37	31315/37	10/66077/15	Ext. Ø 370/Int.Ø335	114,00
	1315/41	31315/41	10/71050/15	Ext. Ø 410/Int.Ø372	123,00
CON REBOSADERO					
	1315/30.2	31315/30.2	10/61814/15	Ext. Ø 305/Int.Ø280	107,00
	1315/37.2	31315/37.2	10/73182/15	Ext. Ø 370/Int.Ø335	126,00
	1315/41.2	31315/41.2	10/77445/15	Ext. Ø 410/Int.Ø372	134,00
	1315/37.2X	31315/37.2X	10/93076/15	Ext. Ø 370/Int.Ø335	160,00
			TEXTURADO / TEXTURED		
SIN REBOSADERO CON VÁLVULA AUTOMÁTICA					
	1315/30.3	31315/30.3	10/63945/15	Ext. Ø 305/Int.Ø280	110,00
	1315/37.3	31315/37.3	10/73182/15	Ext. Ø 370/Int.Ø335	126,00
	1315/41.3	31315/41.3	10/78866/15	Ext. Ø 410/Int.Ø372	136,00
CON REBOSADERO CON VÁLVULA AUTOMÁTICA					
	1315/30.2.3	31315/30.2.3	10/71761/15	Ext. Ø 305/Int.Ø280	124,00
	1315/37.2.3	31315/37.2.3	10/82418/15	Ext. Ø 370/Int.Ø335	142,00
	1315/41.2.3	31315/41.2.3	10/102312/15	Ext. Ø 410/Int.Ø372	176,00
	1315/37.2.3X	31315/37.2.3X	10/104444/15	Ext. Ø 370/Int.Ø335	180,00
		TEXTURADO / TEXTURED			

- Conjunto válvula y sifón de latón cromado.
- Acabado pulido brillo a dos caras (excepto texturado), 1mm de espesor de chapa.
- Embalaje en caja de cartón unitaria.



Lavabos

Acero Inoxidable AISI 304 18/10
Acabado pulido brillo a una cara.
Espesor de chapa 1mm.

Producto	Modelo	Código	Referencia	Dimensión	P.V. €
	CON REBOSADERO				
	1315/51.2	31315/51.2	10/112970/15	Ext. 510x390	195,00
	CON REBOSADERO CON VÁLVULA AUTOMÁTICA				
	1315/51.2.3	31315/51.2.3	10/122206/15	Ext. 510x390	211,00
	CON REBOSADERO				
	1315/52.2	31315/52.2	10/115101/15	Ext. 529x454	198,00
	CON REBOSADERO CON VÁLVULA AUTOMÁTICA				
	1315/52.2.3	31315/52.2.3	10/125759/15	Ext. 529x454	217,00



LAVABOS



Soportes

Fregaderos Industrial

Para los fregaderos	Modelo	Código	Referencia	Dimensión	P.V. €
6615	S-6615	48615	10/123627/86	692x585x850	213,00
6715	S-6715	48715	10/131443/87	692x685x850	227,00
6616-6617-6618	S-6616	48616	10/142086/86	1292x585x850	245,00
6716-6717-6718	S-6716	48716	10/146244/87	1292x685x850	252,00
6617.2-6618.2	S-6617.1	48617.1	10/135155/86	1092x585x850	233,00
6619.1-6620.1	S-6619.1	48619.1	10/153868/86	1692x585x850	265,00
6619-6620-6622	S-6619	48619	10/165651/86	1892x585x850	286,00
6719-6720-6722	S-6719	48719	10/171889/87	1892x685x850	296,00
6621	S-6621	48621	10/214168/86	2592x585x850	369,00
6721	S-6721	48721	10/220406/87	2592x685x850	380,00

- Pies regulables en altura.
- Faldón frontal y laterales en Acero Inox.
- Faldón trasero en chapa de acero electro-zincada.
- Se suministra desmontado con todos los elementos para su montaje.
- Embalaje en caja de cartón unitaria.

Nova

Fregaderos de SMC

Compuestos por resinas y fibras sintéticas unificadas a altas temperaturas.

Blanco/BL

Tierra de Francia/TF

Producto	Modelo	Código	Referencia	Dimensión	P.V. €
	1CE*	8035177/BL 8035178/TF	08/92835/17	860X500 total 840X480 encastre 355X420X200 cubeta	160,00
	Mueble 45 cm.				
	SBSD*	8036177/BL 8036178/TF	19/92835/17	860X500 total 840X480 encastre 333X420X210 cubeta	160,00
	Mueble 60 cm.				
	DB	8036167/BL 8036168/TF	26/103286/16	820X500 total 804X484 encastre 360X430X210 cubeta 360X430X210 cubeta	178,00
	Mueble 80 cm.				
	2C	8035167/BL 8035168/TF	12/103286/16	860x500 total 840x480 encastre 355X420X200 cubeta 355X420X200 cubeta	178,00
	Mueble 80 cm.				
	2CB	8035267/BL 8035268/TF	11/107590/16	767x500 total 741x474 encastre 315X420X185 cubeta 340X335X185 cubeta	186,00
	Mueble 80 cm.				
	1CR	8035157/BL 8035158/TF	13/71932/15	Ø 490 total Ø 460 encastre Ø 360x200 cubeta	124,00
	Mueble 45 cm.				
	2CR	8013167/BL 8013168/TF	32/103286/16	835x440 total 811x416 encastre Ø 365x217 cubeta Ø 365x217 cubeta	178,00
	Mueble 80 cm.				

FREGADEROS
SINTÉTICOS

- *Fregadero reversible.
- Todos los fregaderos incluyen válvula cestilla de 3^{1/2}" de acero inoxidable, grapas de sujeción y junta de estanqueidad.
- Embalaje en caja de cartón unitaria.

MODOS DE INSTALACIÓN HOW TO INSTALL

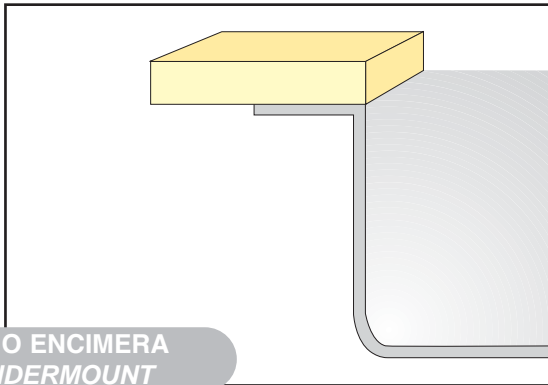

BAJO ENCIMERA
UNDERMOUNT

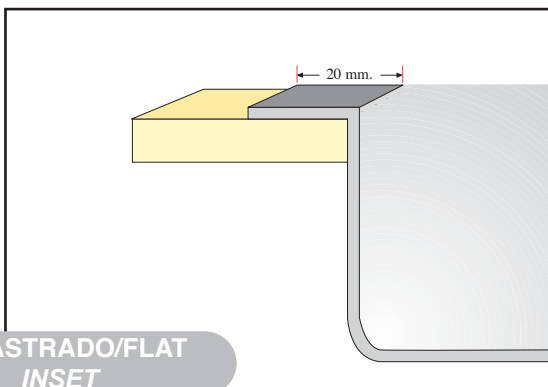

ENCASTRADO/FLAT
INSET

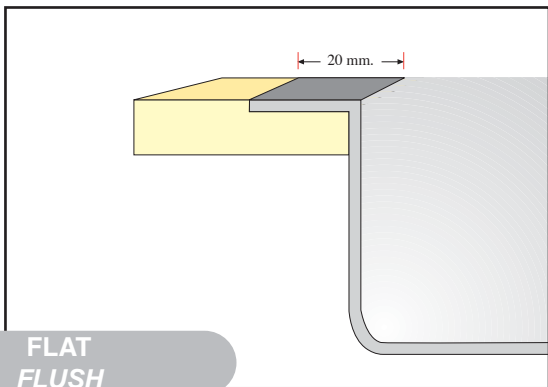

FLAT
FLUSH



Navarrete e Hijos, S.A.

C/ Albacete, 9
Tel. 34-961 309 071 - Fax. 34-961 392 429
46113 - MONCADA (Valencia) SPAIN
www.nayes.es / e-mail:nayes@nayes.es/export@nayes.es

NAYES, empresa fundada en el año 1927 y líder en el sector de transformación de metales en España, adaptadas a las exigencias de los mercados internacionales.

NAYES, founded in 1927 and a leading Spanish company in the metal transforming sector, equipped to meet the demands of the international markets.

NAYES, entreprise fondée en 1927 et leader dans le secteur de transformation de métaux en Espagne, adaptées aux exigences des marchés internationaux.

NAYES, im Jahr 1927 gegründet und Markführer in der Branche der Metall verarbeitenden Industrie Spaniens, präsentiert die neue Modelreihe aus rostfreien AISI 304 18/10 Edelstahlspülbecken, deren Modelle den Ansprüchen der internationalen Märkte gerecht werden.



Para permitir incorporar las mejoras derivadas de nuestra constante investigación, las características de los productos presentados en este catálogo, podrán ser modificadas sin previo aviso.

To be able to incorporate the improvements derived from our constant research, the characteristics of the products shown in this catalogue could be modified without notice.

Pour permettre d'incorporer les améliorations dérivées de notre constante recherche, les caractéristiques des produits présentés dans ce catalogue, pourront être modifiées sans avis préalable.

Um die Ergebnisse unserer ständigen Forschungsarbeit zur Verbesserung unserer Produkte in die Tat umzusetzen, können die Eigenschaften der im Katalog vorgestellten Produkte ohne Vorankündigung geändert werden.

© Tela Marinera Publicidad 96 579 66 11

