

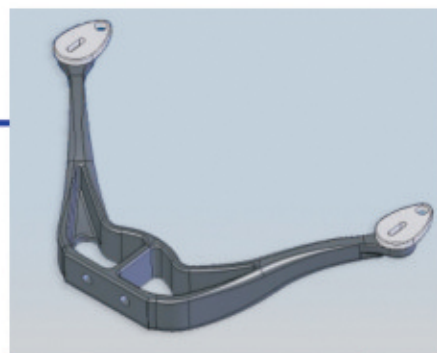

Araña WT-I

1B, 2B, 3B, 4B

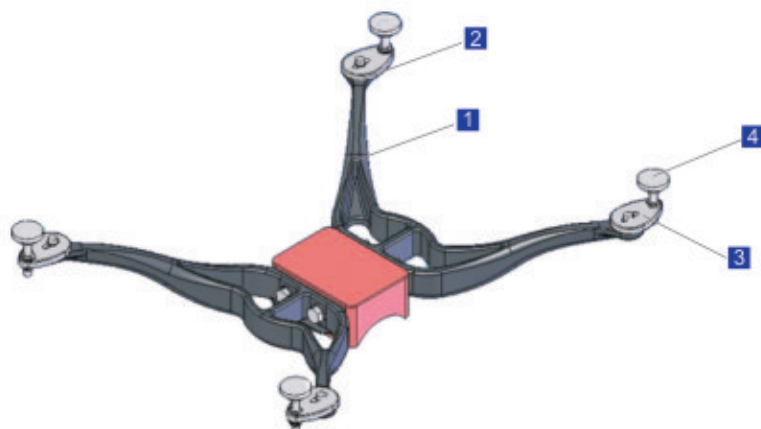
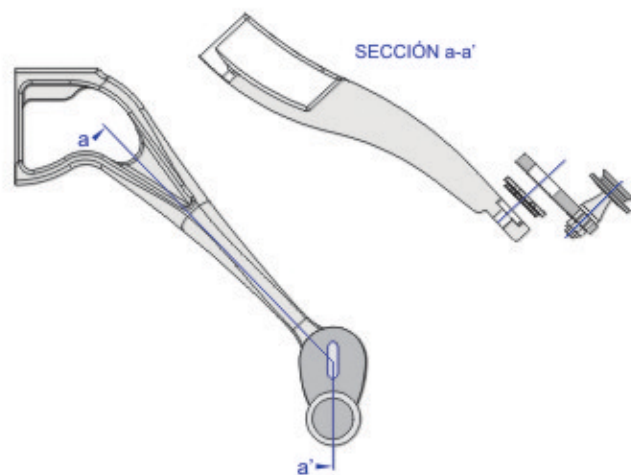
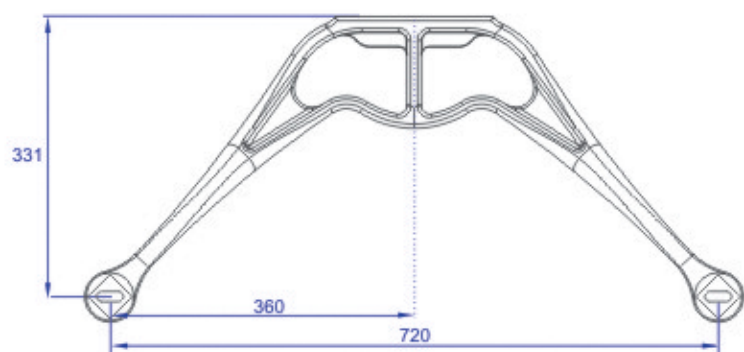
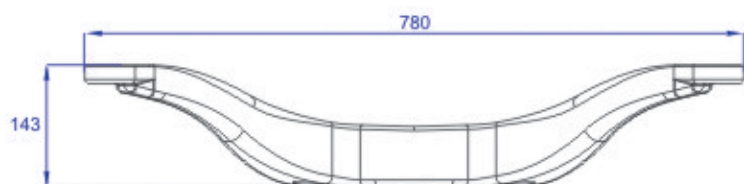

Araña WT-I de microfusión en acero inoxidable AISI-316 con acabado superficial satinado y límite elástico mínimo de 210 MPa. Mecanizado de alta precisión en centro de control numérico.

WT-I spider : Lost wax AISI-316 stainless steel casting with satin finish and 210 MPa minimum elastic limit. High precision CNC mechanized.

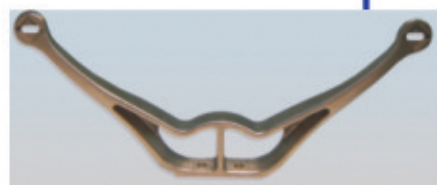
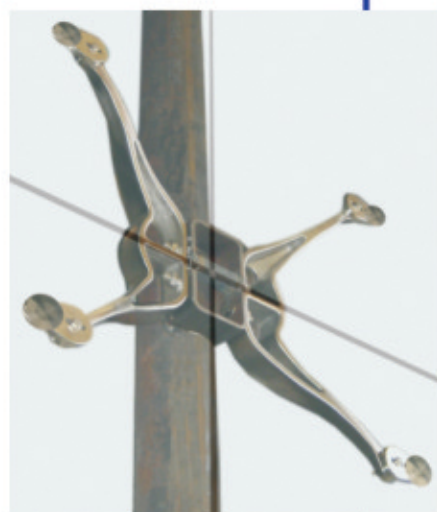

Pieza Part	Descripción Description
1	araña spider
2	conector circular circular connector
3	conector ovoidal oval connector
4	rótula articulated bolt