

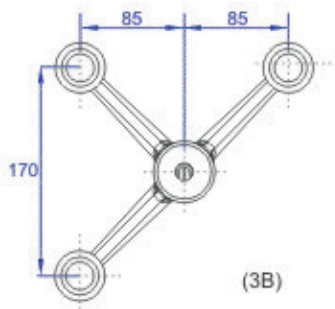

Araña AL-I

1BV, 1B, 2BV, 2B, 3B, 4B

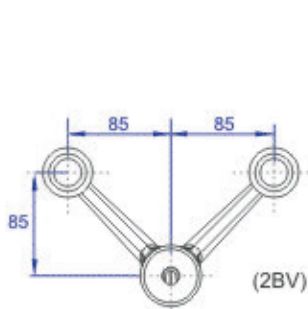
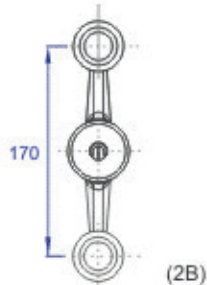
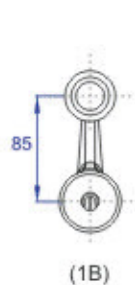
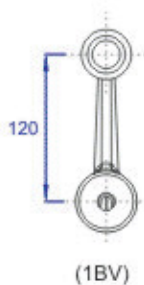
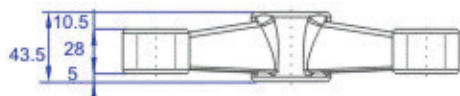
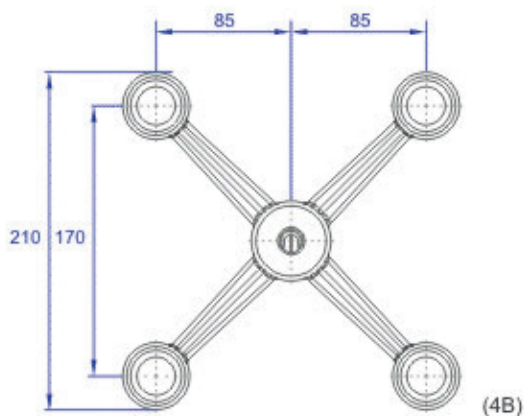
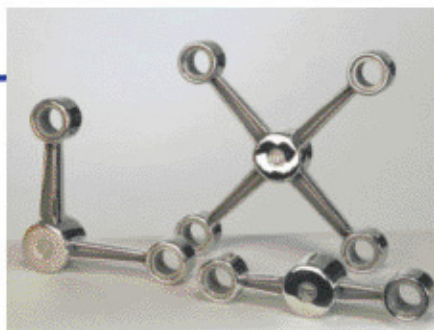

Araña AL-I de microfundición en acero inoxidable AISI-316 con acabado superficial pulido brillante o granallado y límite elástico mínimo de 210 Mpa. Mecanizado de alta precisión en centro de control numérico.

AL-I spider : Lost wax AISI-316 stainless steel casting with mirror polish or sand blasted surface and 210 MPa minimum elastic limit. High precision CNC mechanized.

