



Presentation Plot 2 Leds Under Cabinet Lighting

9th March 2005

(1st Version)

Tel: +34 93 630 28 00

Fax: +34 93 630 29 66

3D View - Plot 2 LEDs

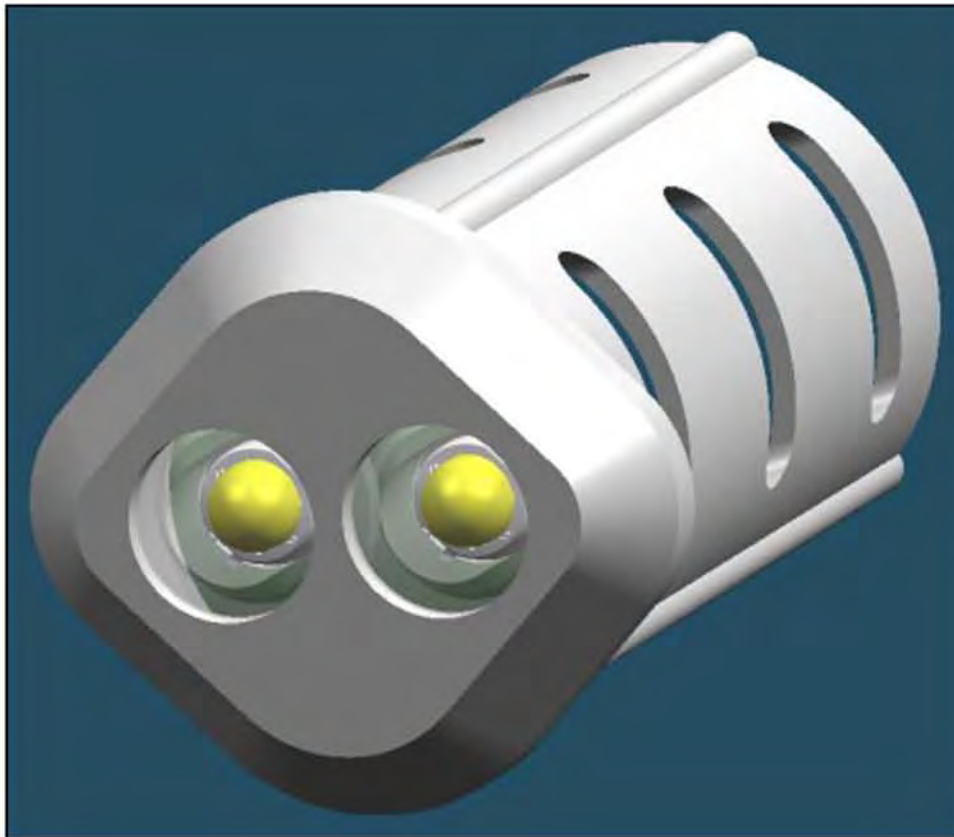

Option A
Front View

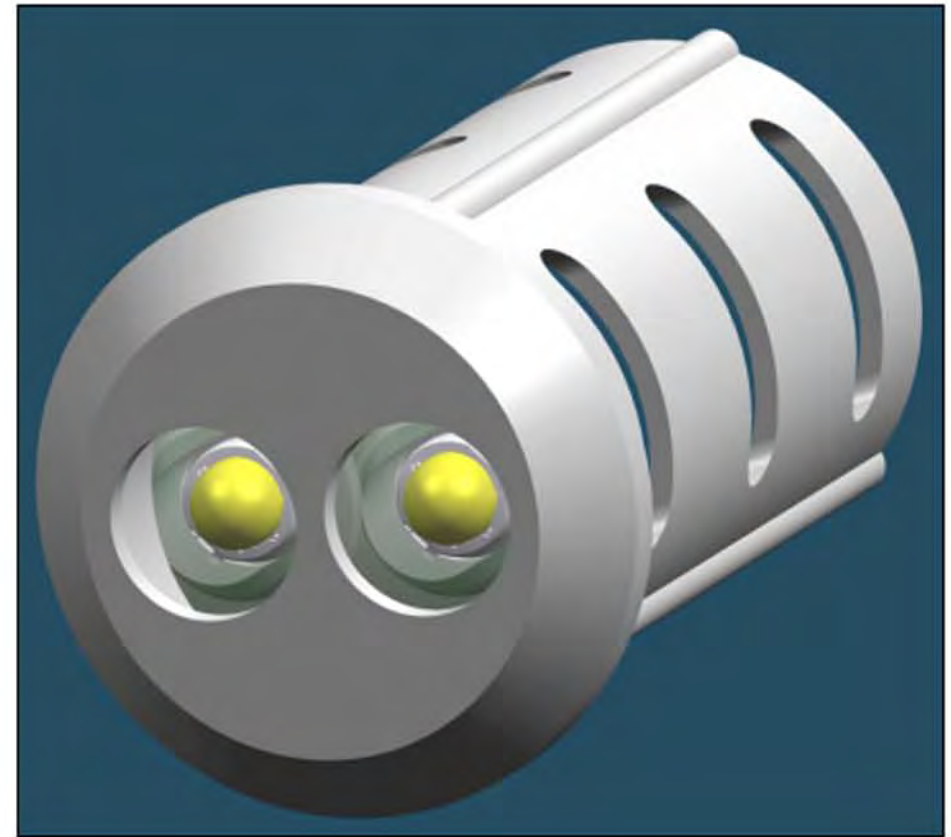

Option B
Front View

3D View - Plot 2 LEDs

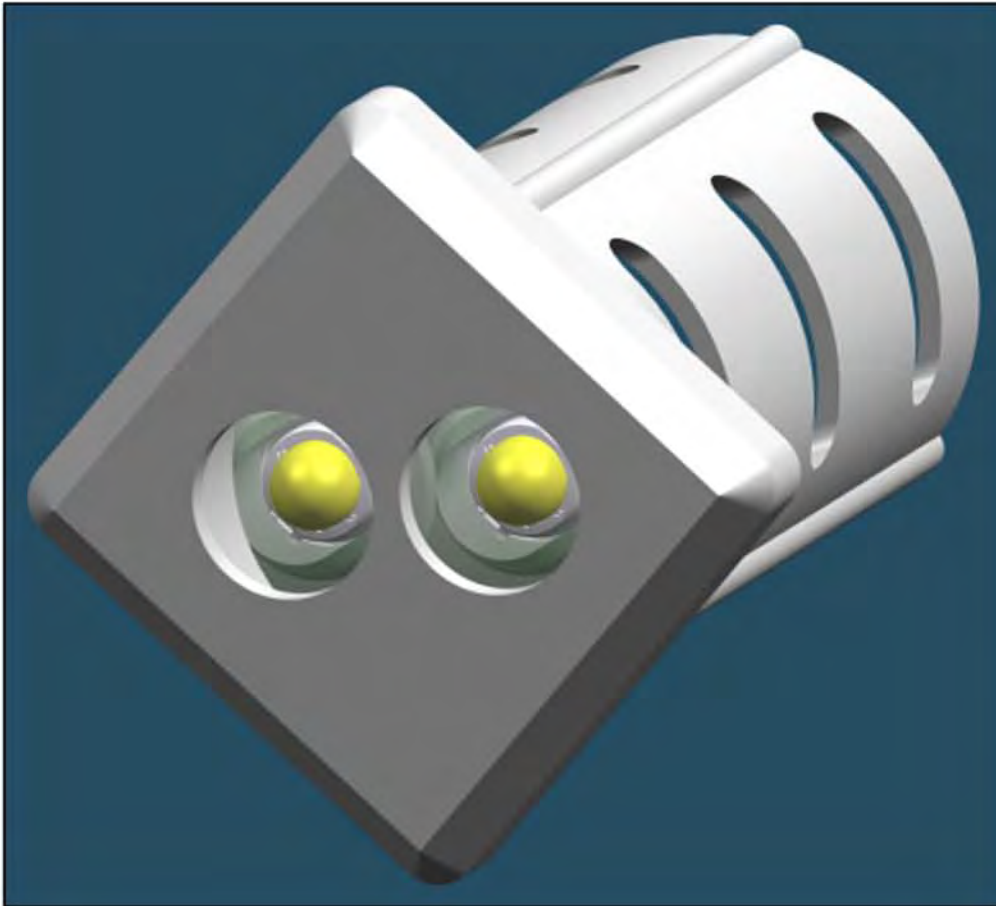

Option C
Front View

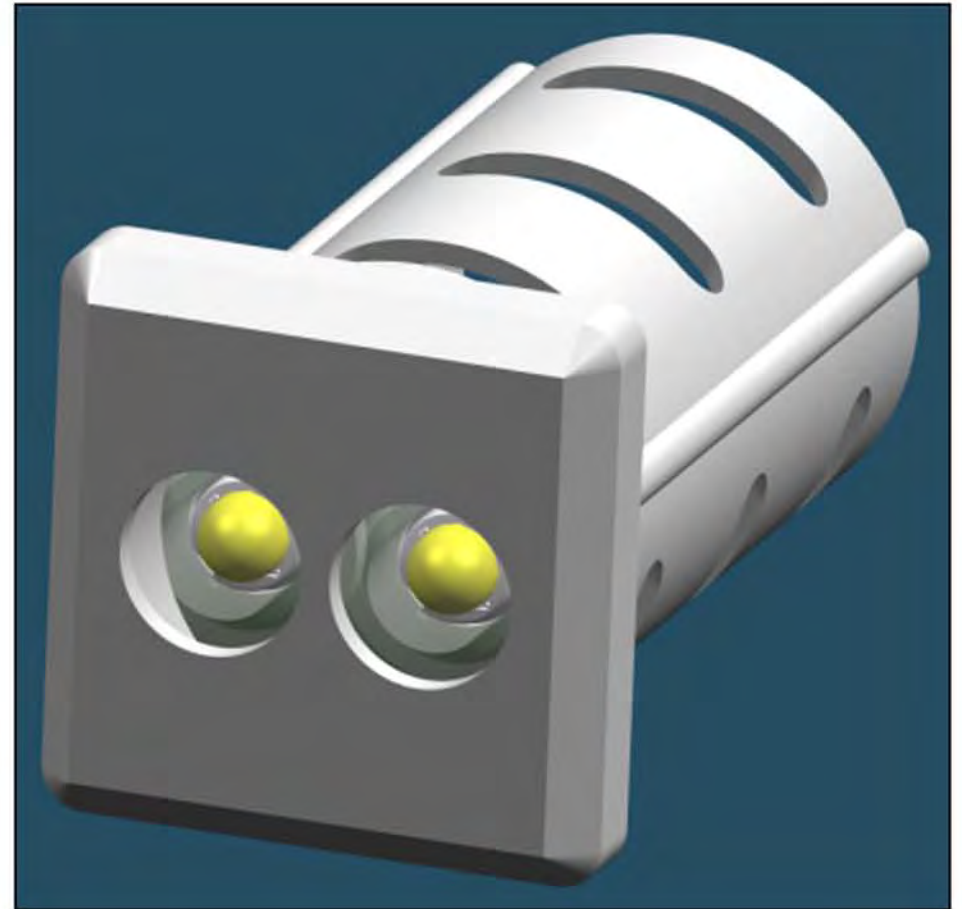

Option D
Front View

General Measures - Plot 2 LEDs

Aprox. Measures in mm

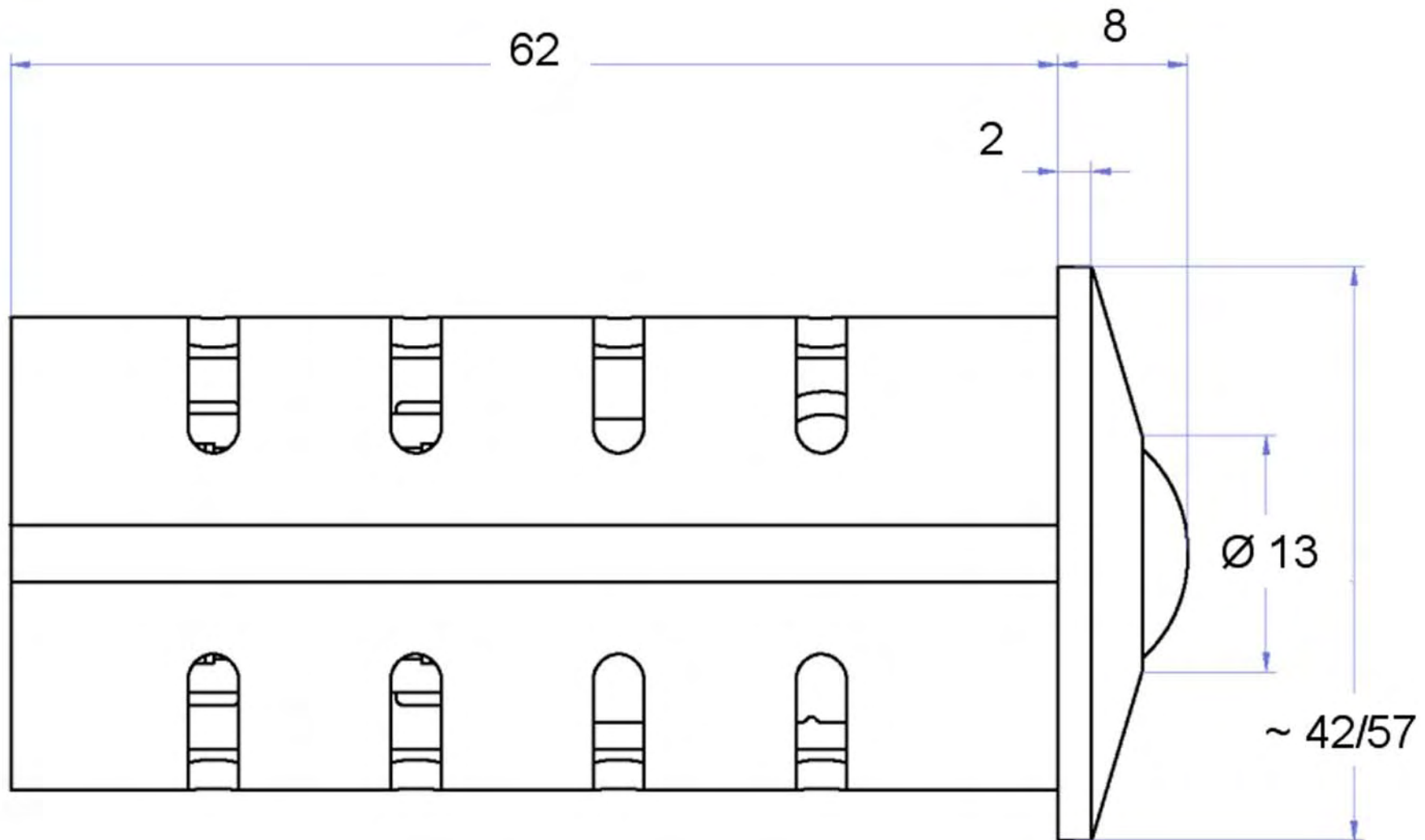

Side View

Instalation - Plot 2 LEDs

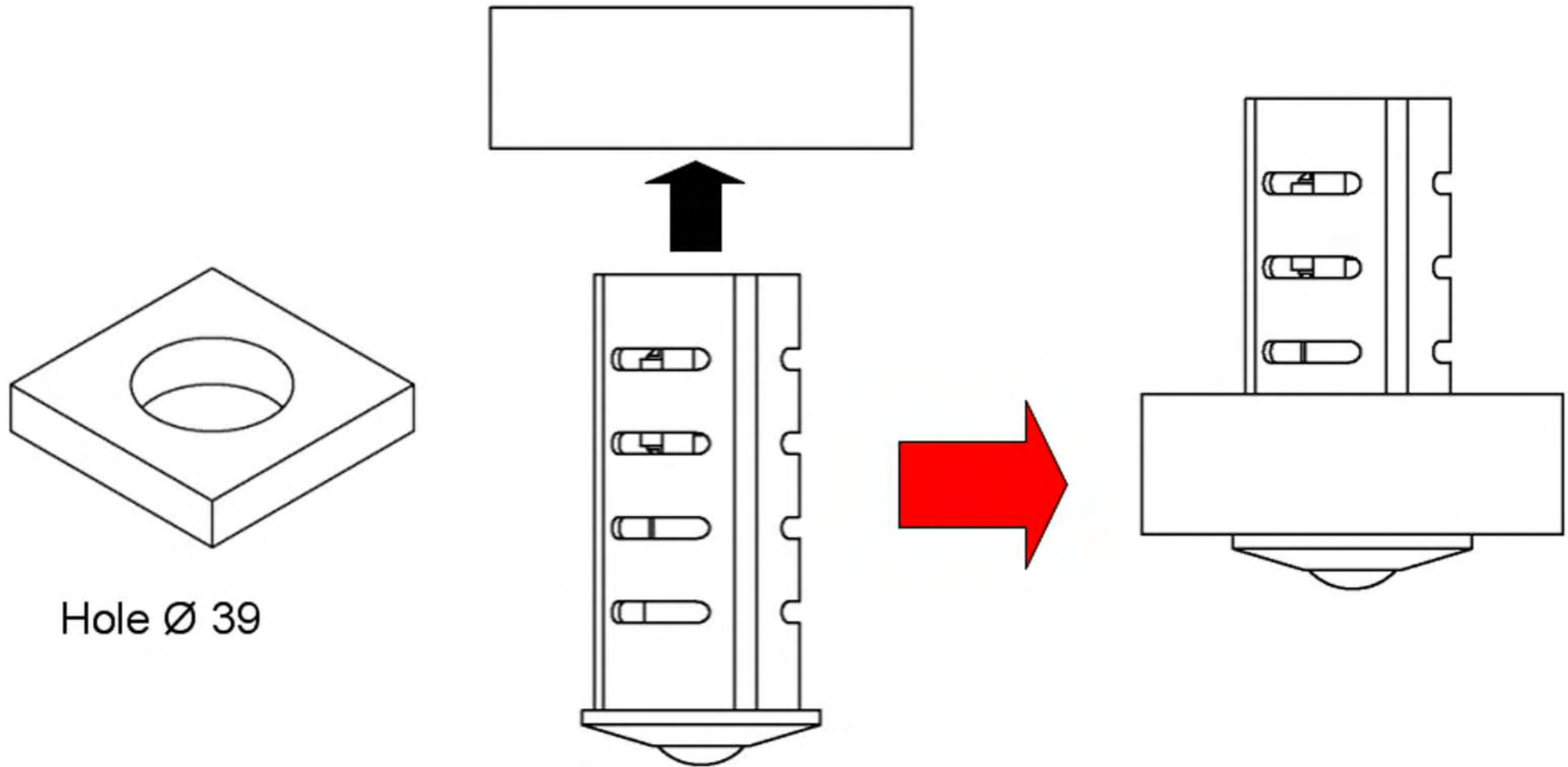

Hole Ø 39

Aprox. Measures in mm

Instalation Measures - Plot 2 LEDs

Aprox. Measures in mm

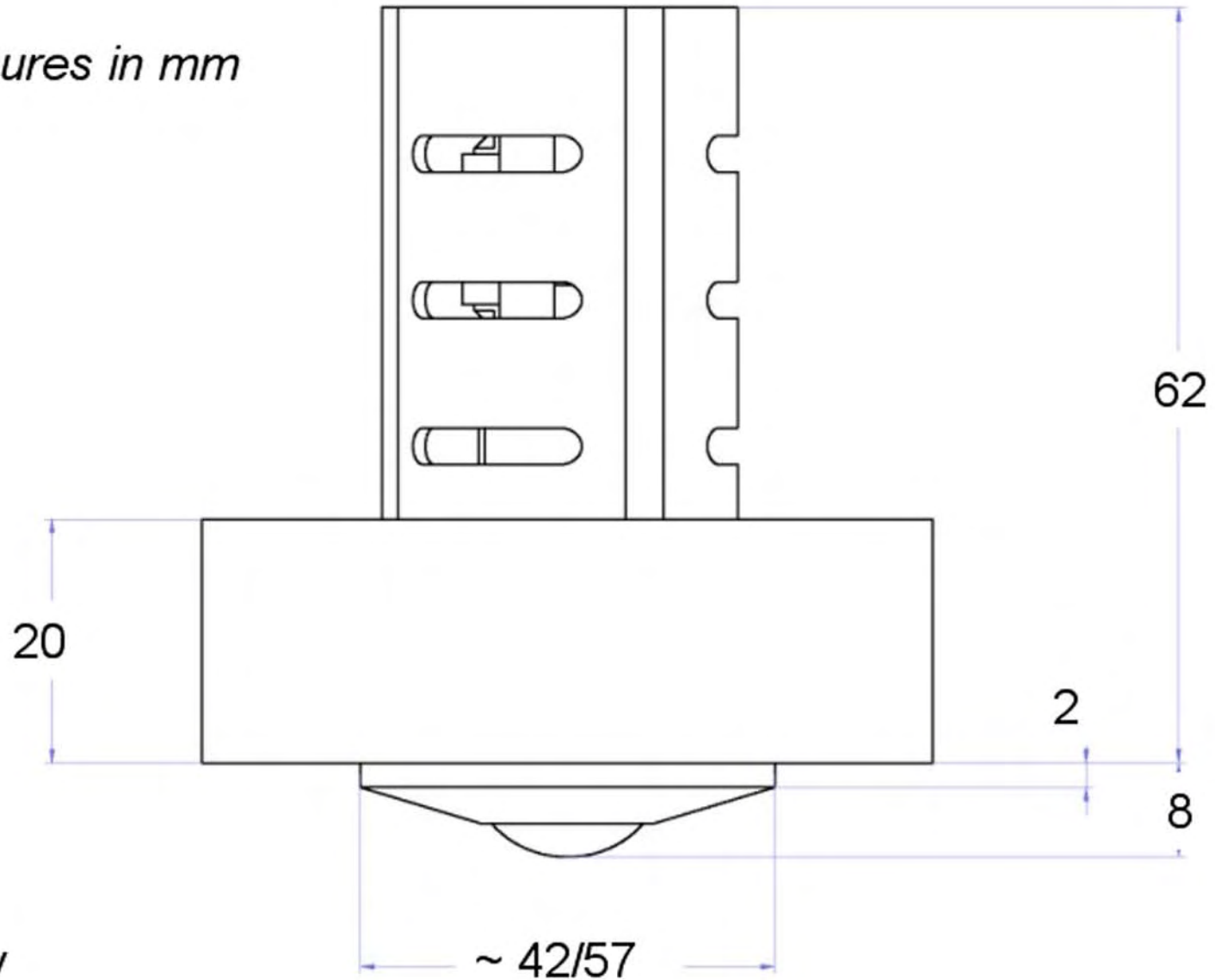

Side View

