

moderno

poliamida



ÍNDICE DE SERIES





•1304

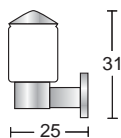

•1308

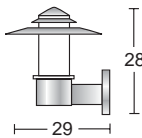

•1307-1 ▲ 30 cm
•1307-2 ▲ 57 cm
•1307-3 ▲ 88 cm
BASES Ø 15 cm



•1303-1 ▲ 34 cm
•1303-2 ▲ 61 cm
•1303-3 ▲ 92 cm
BASES Ø 15 cm

Material: Poliamida

Cabezas: Cristal decorado

Acabados: Negro o Gris

Especiales (ver pág. 156)

IP-44 Clase II



100W	7W >>	•1308	•1309
100W	15W >>	•1306	•1307
100W	20W >>	•1302	•1303
100W	23W >>	•1304	•1305 •1310 •1311



• 1306

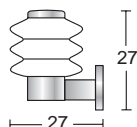

• 1302

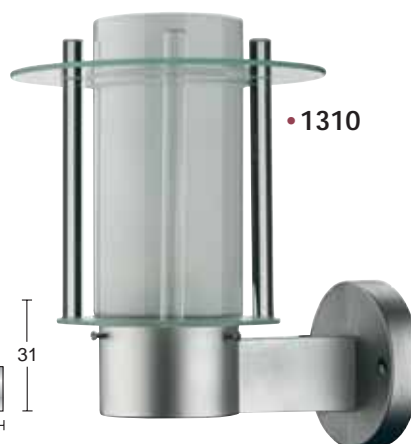
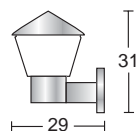

• 1310

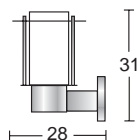

• 1305-1 ▲ 34 cm
• 1305-2 ▲ 61 cm
• 1305-3 ▲ 92 cm
BASES Ø 15 cm

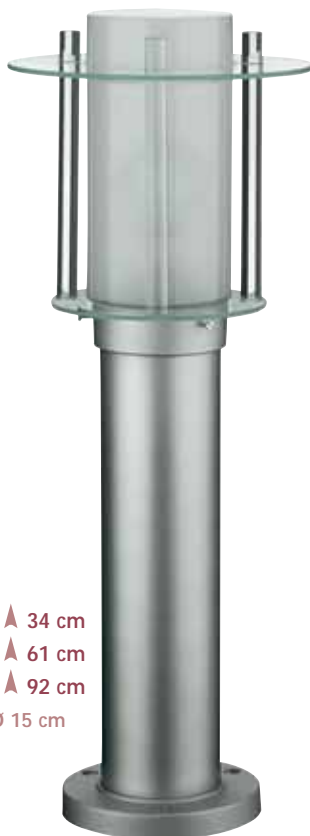

• 1311-1 ▲ 34 cm
• 1311-2 ▲ 61 cm
• 1311-3 ▲ 92 cm
BASES Ø 15 cm

• 1309-1 ▲ 31 cm
• 1309-2 ▲ 58 cm
• 1309-3 ▲ 89 cm
BASES Ø 15 cm





- 1319-1 ▲ 36 cm
 - 1319-2 ▲ 61 cm
 - 1319-3 ▲ 86 cm
- BASES 12x19 cm



Material: Aluminio inyectado >> •1318 •1319

Poliamida >> •1300 •1301

Difusor: Cristal decorado

Acabados: Negro o Gris

Especiales (ver pág. 156)

IP-44 Clase I



- 100W 15W >> •1315
100W 20W >> •1312 •1314 •1324 •1325
100W 23W >> •1300 •1301 •1313 •1318 •1319



• 1313

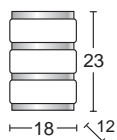

• 1312

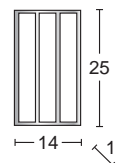

• 1315

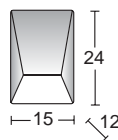

• 1314

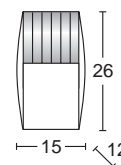

• 1324

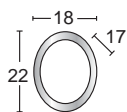

• 1325

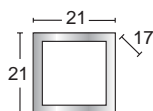

• 1314



• 1386

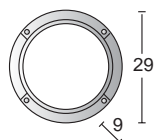

• 1386



• 1387



pág.159

Material: Polipropileno

Difusor: Cristal

Acabados: Blanco, Negro o Gris
Especiales (ver pág. 156)

IP-54 Clase I



G-24 d3

26W



• 1388

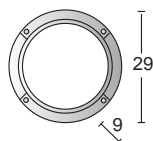

> accesorios opcionales
embellecedor

• AC-16



visera

• AC-17



• 1388+AC-16



• 1388+AC-17



Material: Polipropileno

Difusor: Cristal

Acabados: Blanco, Negro o Gris
Especiales (ver pág. 156)

G-24 d3
26W

IP-54 Clase I



• 1460



• 1457

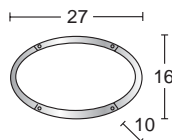
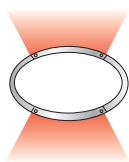

• 1458



• 1459



Material: Polipropileno

Difusor: Cristal

Acabados: Negro o Gris
Especiales (ver pág. 156)

IP-54 Clase I



18W

> accesorio opcional
para instalar los plafones 1457, 1458 inclinados



•AC-1



> ejemplo •1458+AC-1



•1461

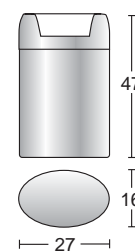



• 1453



• 1454

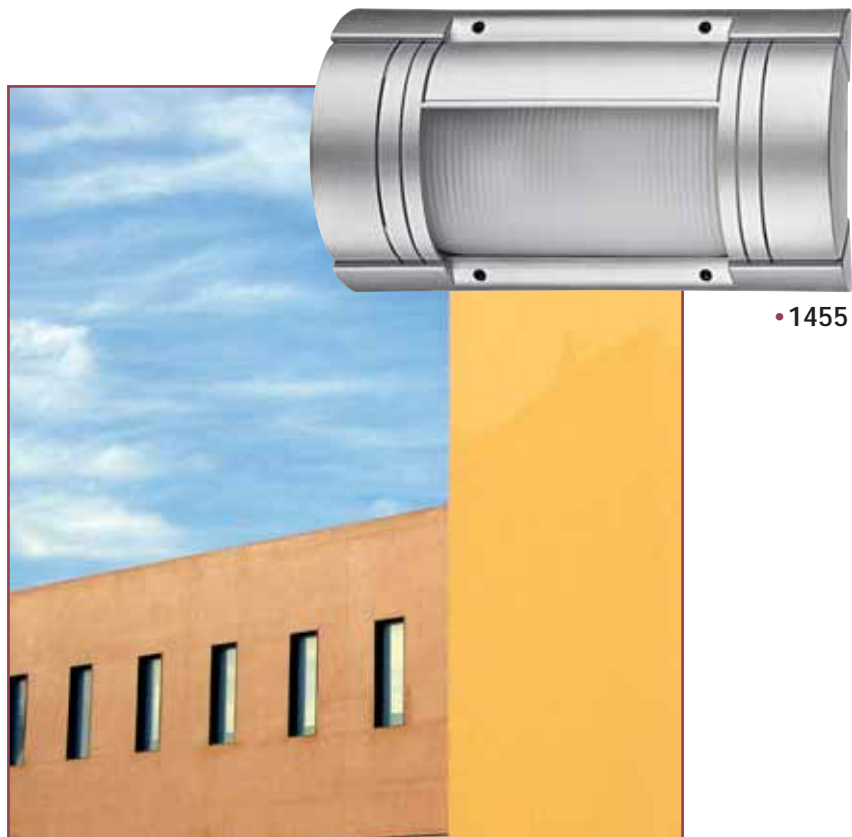
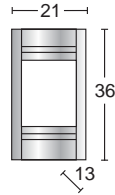

• 1455



Material: Poliamida

Difusor: Cristal

Acabados: Negro o Gris
Especiales (ver pág. 156)

IP-54 Clase I

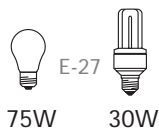



•1462+AC-2+AC-3



•1462

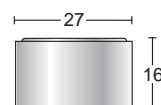

> accesorios opcionales

adaptador de pared



•AC-2

rejilla



•AC-3



Material: Poliamida

Difusor: Cristal

Acabados: Negro o Gris

Especiales (ver pág. 156)

IP-54 Clase I

Gx24 d3
26W



•58

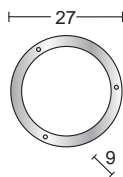
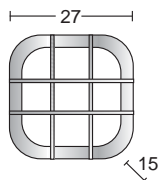

•60
•60 PL

> plafones multiposición
•58 •59 adaptables a
techo pared y rincones



•59

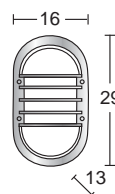

•57



•67

GLOBOS: Ø15 cm



•68

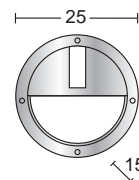

•66
•66 PL

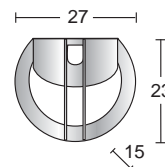

Material: Nylon

Difusor: Policarbonato
Cristal •59 •67 •68

Acabados: Blanco o Negro

IP-43 Clase II



E-27



G-24 d3

60W 11W >> •67 •68
60W 15W >> •57 •58 •59 •66
60W - >> •60

26W >> •60 PL •66 PL



•1662

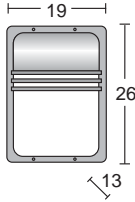

•1663

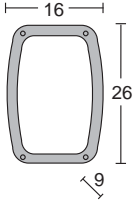

•1665



•1664



Material: Nylon
Difusor: Policarbonato
Acabados: Blanco o Negro Negro o Gris >> •1662

IP-55 Clase II ∇ >> • 1662
IP-55 Clase II ∇ >> • 1663 •1664 • 1665

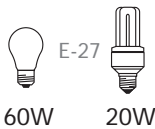

FAR

MODERNO POLIAMIDA

SERIE ECONÓMICA



- 1655-2
- 1655-1
- 1655-0



- 1657-2
- 1657-1
- 1657-0

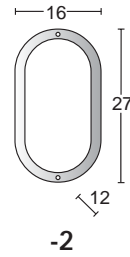
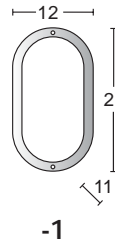
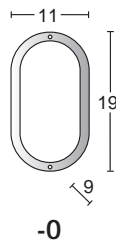

- 1656-1
- 1656-2



- 1658-2
- 1658-1

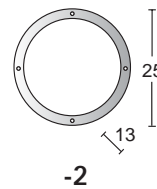
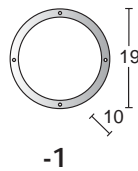

Material: Nylon

Difusor: Cristal

Acabados: Negro o Blanco

IP-44 Clase II



60W 20W >> •-2
60W >> •-0 •-1

SERIE ECONÓMICA

MODERNO POLIAMIDA

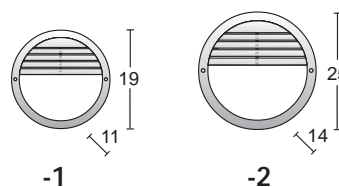
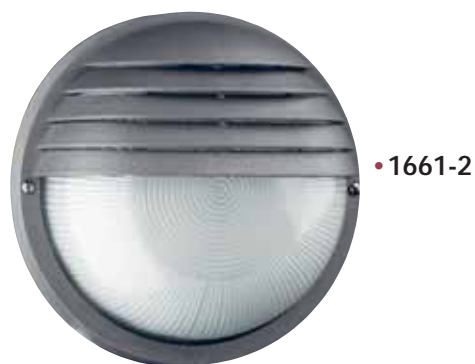
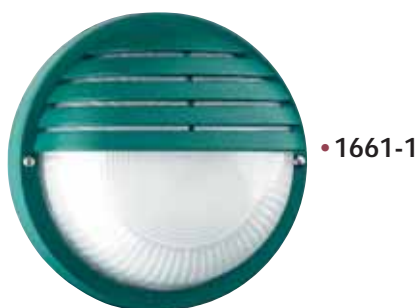
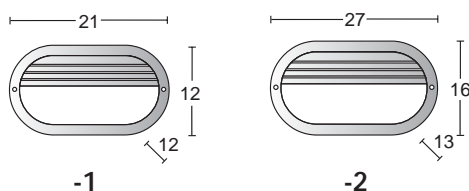

Material: Nylon

Difusor: Cristal

Acabados: Blanco, Negro
Gris o Verde

IP-44 Clase II

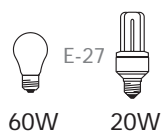

- 2 >> 60W
- 1 >> 60W
- 1659-1 >> 40W

> se suministran con cable-clavija de 1,8 mts.



Material: Poliamida

Difusor: Cristal

Acabados: Negro

Especiales (ver pág. 156)

IP-44 Clase II

E-14
60W

> 2 versiones para interior o exterior



• 204-20 Interior
• 205-20 Exterior
Ø 20 cm



• 204-25 Interior
• 205-25 Exterior
Ø 25 cm



• 204-30 Interior
• 205-30 Exterior
Ø 30 cm



• 204-40 Interior
• 205-40 Exterior
Ø 40 cm



- > • 204 se suministran con cable-clavija de 2 mts. con interruptor.
- > • 205 se suministran con cable-clavija de 2 mts.



Material: Poliamida

Globo: Polimetacrilato

Acabados: Negro

Especiales (ver pág. 156)



-20	>>	60W	15W
-25	>>	100W	30W
-30	>>	150W	30W
-40	>>	150W	30W

IP-40 Clase II >> • 204

IP-44 Clase II >> • 205



•65

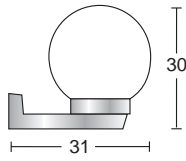

•62

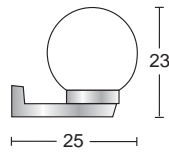

•63

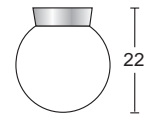

•62



•64 ▲ 35 cm
BASE ø 14 cm

Material: Poliamida

Globo: Polimetacrilato ø20cm
Polimetacrilato ø25cm >> •65

Acabados: Blanco o Negro
Especiales (ver pág. 156)

IP-43 Clase II



40W 15W
60W 30W >> •65



- 54-1 ▲ 45 cm
 - 54-2 ▲ 65 cm
 - 54-3 ▲ 105 cm
 - 54-4 ▲ 145 cm
- BASES: Ø 17 cm



- 53 ▲ 40 cm
- BASE: Ø 14 cm



Material: Poliamida

Globo: Polimetacrilato ø25cm

Acabados: Blanco o Negro
sólo Negro •54
Especiales (ver pág. 156)

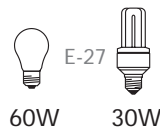

IP-44 Clase II