

VERTICAL OUTPUT

SALIDA VERTICAL

SORTIE VERTICALE

PESO: 50 Kgs. (SIN MOTOR)
WEIGHT: 50 Kgs. (WITHOUT MOTOR)
POIDS: 50 Kgs. (SANS MOTEUR)

IZQ. NORMAL
LEFT STANDARD
GAUCHE NORMALE

DER. (BAJO PEDIDO)
RIGHT. (TO ORDER)
DROITE (SUR COMMANDE)

HORIZONTAL OUTPUT

SALIDA HORIZONTAL

SORTIE HORIZONTALE

PESO: 50 Kgs. (SIN MOTOR)
WEIGHT: 50 Kgs. (WITHOUT MOTOR)
POIDS: 50 Kgs. (SANS MOTEUR)

IZQ. NORMAL
LEFT STANDARD
GAUCHE NORMALE

DER. (BAJO PEDIDO)
RIGHT. (TO ORDER)
DROITE (SUR COMMANDE)

PESO: 11 Kgs.
WEIGHT: 11 Kgs.
POIDS: 11 Kgs.

GRAFICO DE CURVAS DE RENDIMIENTO VENTILADOR SIMPLE ASPIRACION TIPO M.S.O. 10/5

PERFORMANCE CURVE GRAPH. SIMPLE SUCTION FAN M.S.O. 10/5 TYPE / GRAPHIQUE DE COURBES DE RENDEMENT VENTILATEUR D'ASPIRATION SIMPLE TYPE M.S.O. 10/5

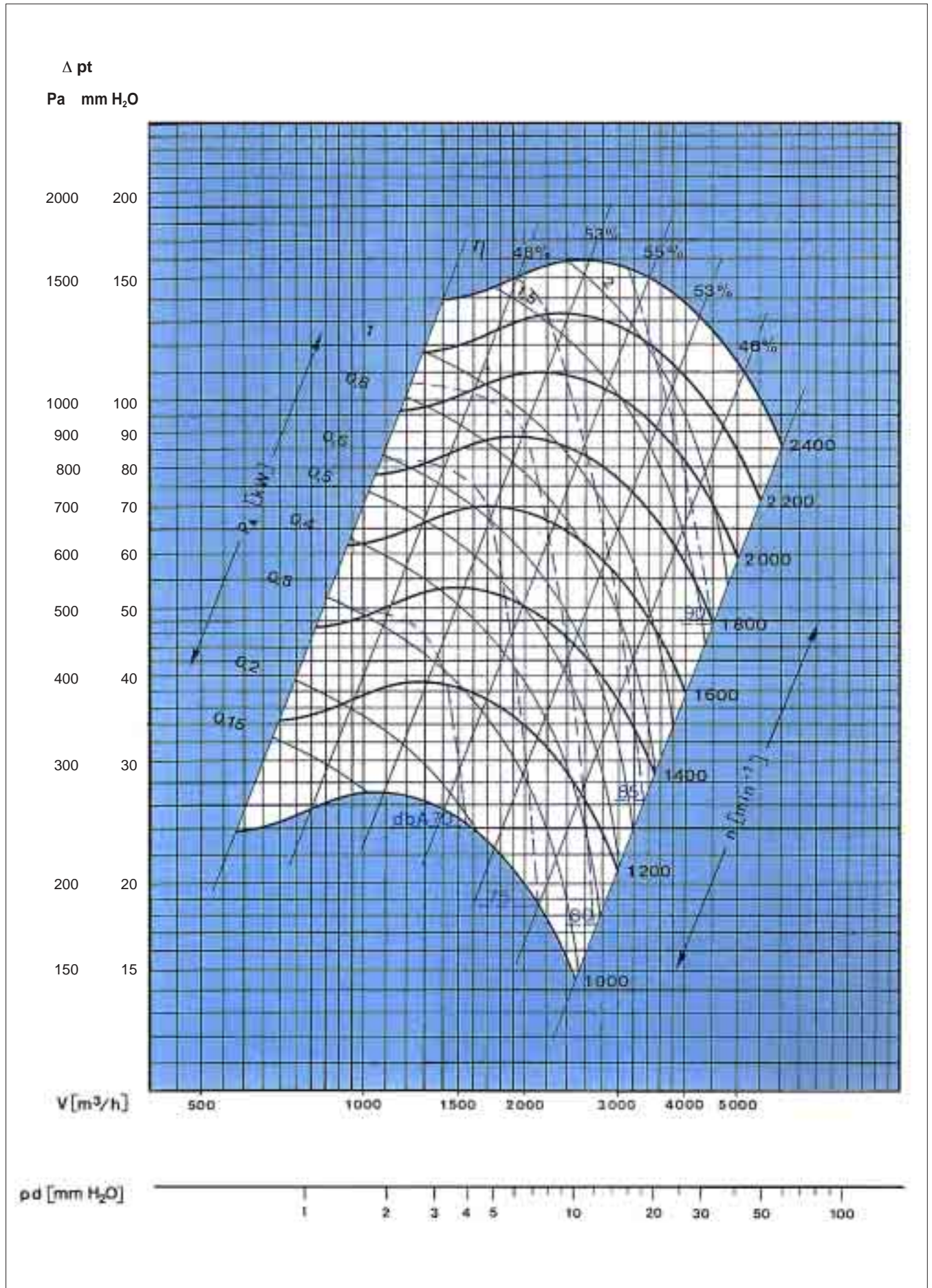

VERTICAL OUTPUT

SALIDA VERTICAL

SORTIE VERTICALE

PESO: 63 Kgs. (SIN MOTOR)
WEIGHT: 63 Kgs. (WITHOUT MOTOR)
POIDS: 63 Kgs. (SANS MOTEUR)

IZQ. NORMAL
LEFT STANDARD
GAUCHE NORMALE

DER. (BAJO PEDIDO)
RIGHT (TO ORDER)
DROITE (SUR COMMANDE)

HORIZONTAL OUTPUT

SALIDA HORIZONTAL

SORTIE HORIZONTALE

PESO: 63 Kgs. (SIN MOTOR)
WEIGHT: 63 Kgs. (WITHOUT MOTOR)
POIDS: 63 Kgs. (SANS MOTEUR)

IZQ. NORMAL
LEFT STANDARD
GAUCHE NORMALE

DER. (BAJO PEDIDO)
RIGHT (TO ORDER)
DROITE (SUR COMMANDE)

PESO: 15 Kgs.
WEIGHT: 15 Kgs.
POIDS: 15 Kgs.

GRAFICO DE CURVAS DE RENDIMIENTO VENTILADOR SIMPLE ASPIRACION TIPO M.S.O. 12/6

PERFORMANCE CURVE GRAPH. SIMPLE SUCTION FAN M.S.O. 12/6 TYPE / GRAPHIQUE DE COURBES DE RENDEMENT VENTILATEUR D'ASPIRATION SIMPLE TYPE M.S.O. 12/6

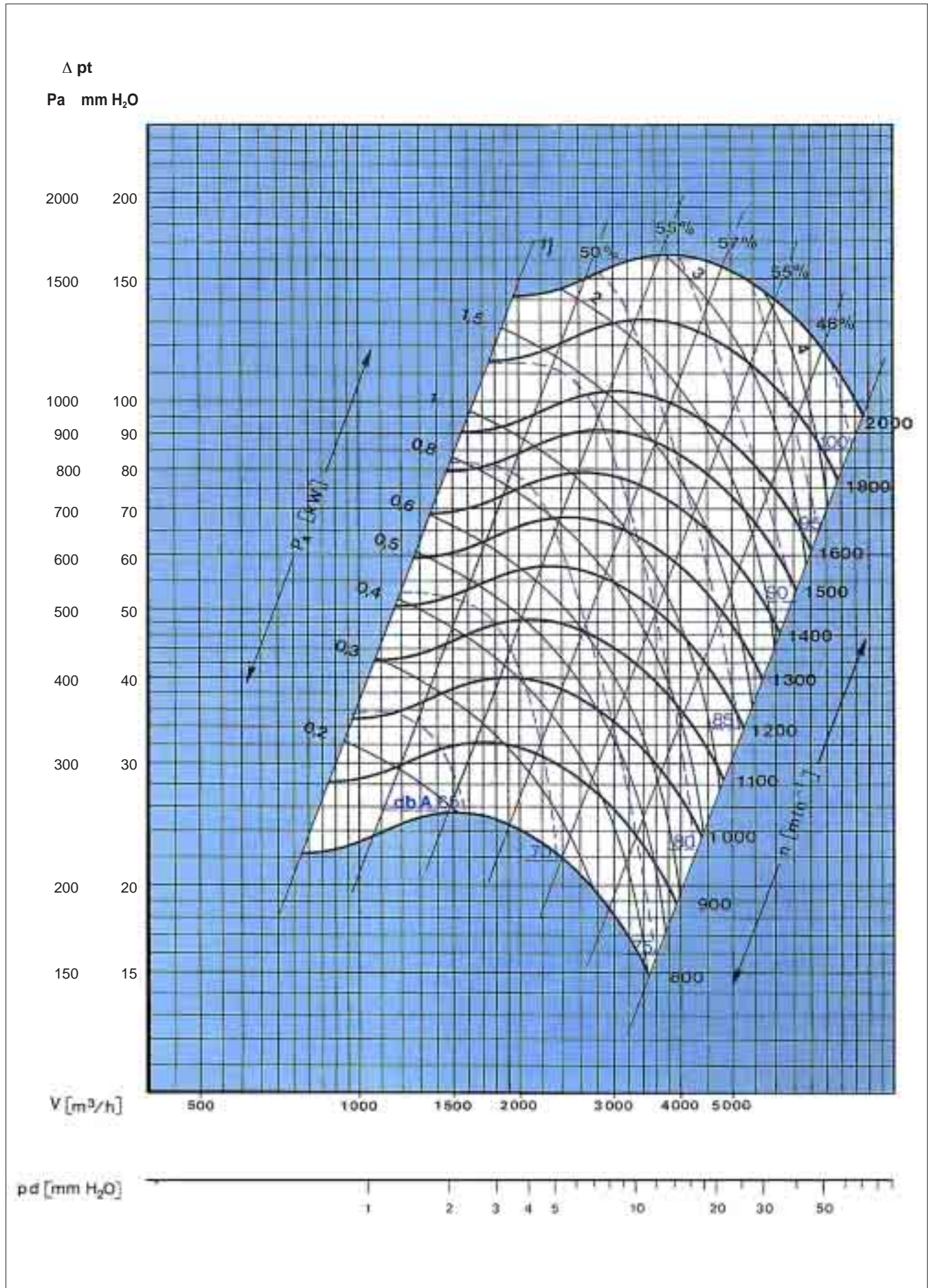

VERTICAL OUTPUT

SALIDA VERTICAL

SORTIE VERTICALE

PESO: 77 Kgs. (SIN MOTOR)
WEIGHT: 77 Kgs. (WITHOUT MOTOR)
POIDS: 77 Kgs. (SANS MOTEUR)

IZQ. NORMAL
LEFT STANDARD
GAUCHE NORMALE

DER. (BAJO PEDIDO)
RIGHT (TO ORDER)
DROITE (SUR COMMANDE)

HORIZONTAL OUTPUT

SALIDA HORIZONTAL

SORTIE HORIZONTALE

PESO: 77 Kgs. (SIN MOTOR)
WEIGHT: 77 Kgs. (WITHOUT MOTOR)
POIDS: 77 Kgs. (SANS MOTEUR)

IZQ. NORMAL
LEFT STANDARD
GAUCHE NORMALE

DER. (BAJO PEDIDO)
RIGHT (TO ORDER)
DROITE (SUR COMMANDE)

PESO: 23 Kgs.
WEIGHT: 23 Kgs.
POIDS: 23 Kgs.

GRAFICO DE CURVAS DE RENDIMIENTO VENTILADOR SIMPLE ASPIRACION TIPO M.S.O. 15/7,5

PERFORMANCE CURVE GRAPH. SIMPLE SUCTION FAN M.S.O. 15/7,5 TYPE / GRAPHIQUE DE COURBES DE RENDEMENT VENTILATEUR D'ASPIRATION SIMPLE TYPE M.S.O. 15/7,5

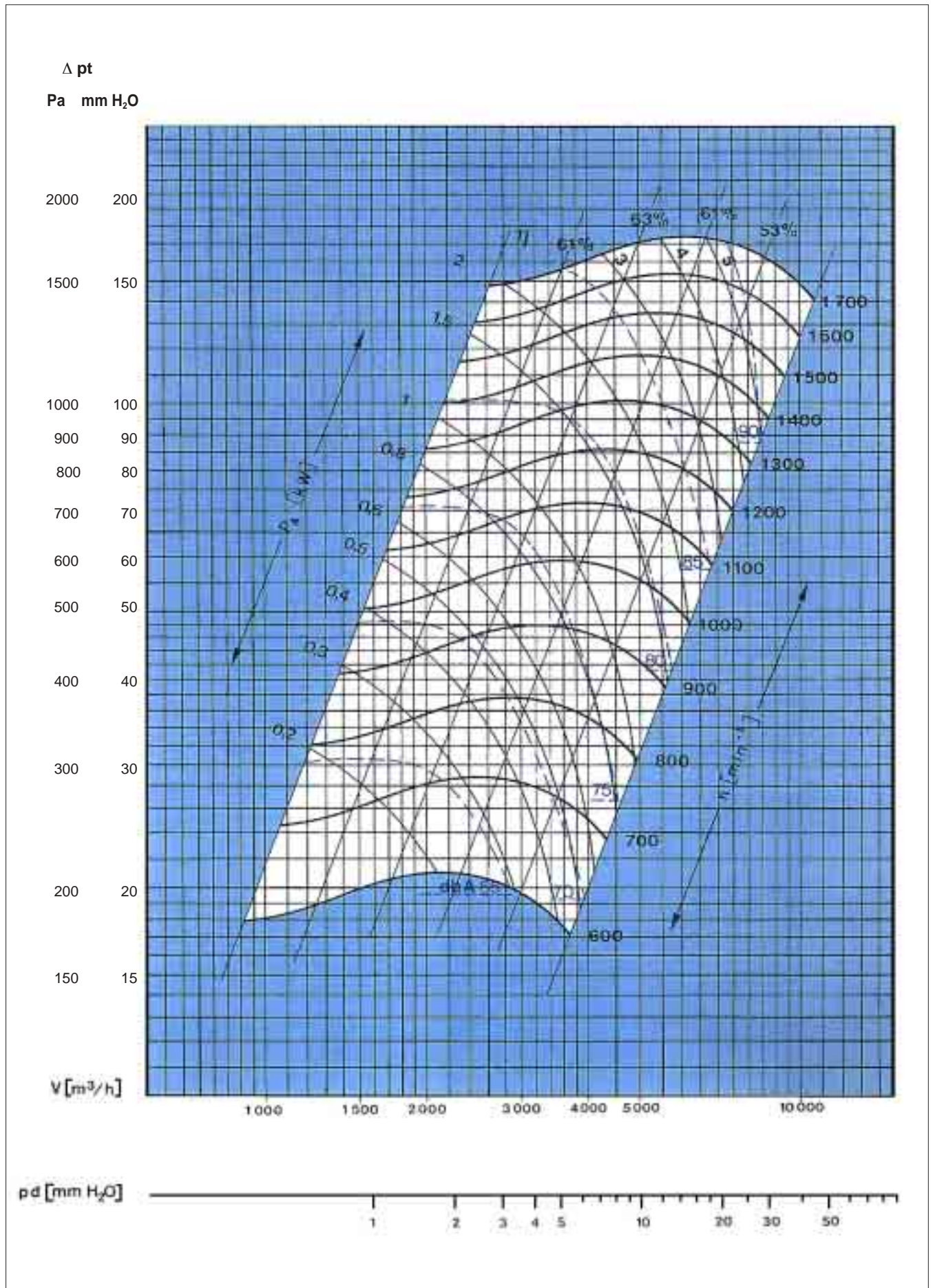

VERTICAL OUTPUT

SALIDA VERTICAL

SORTIE VERTICALE

PESO: 93 Kgs. (SIN MOTOR)
WEIGHT: 93 Kgs. (WITHOUT MOTOR)
POIDS: 93 Kgs. (SANS MOTEUR)

IZQ. NORMAL
LEFT STANDARD
GAUCHE NORMALE

DER. (BAJO PEDIDO)
RIGHT (TO ORDER)
DROITE (SUR COMMANDE)

HORIZONTAL OUTPUT

SALIDA HORIZONTAL

SORTIE HORIZONTALE

PESO: 93 Kgs. (SIN MOTOR)
WEIGHT: 93 Kgs. (WITHOUT MOTOR)
POIDS: 93 Kgs. (SANS MOTEUR)

IZQ. NORMAL
LEFT STANDARD
GAUCHE NORMALE

DER. (BAJO PEDIDO)
RIGHT (TO ORDER)
DROITE (SUR COMMANDE)

PESO: 30 Kgs.
WEIGHT: 30 Kgs.
POIDS: 30 Kgs.

GRAFICO DE CURVAS DE RENDIMIENTO VENTILADOR SIMPLE ASPIRACION TIPO M.S.O. 18/9

PERFORMANCE CURVE GRAPH. SIMPLE SUCTION FAN M.S.O. 18/9 TYPE / GRAPHIQUE DE COURBES DE RENDEMENT VENTILATEUR D'ASPIRATION SIMPLE TYPE M.S.O. 18/9

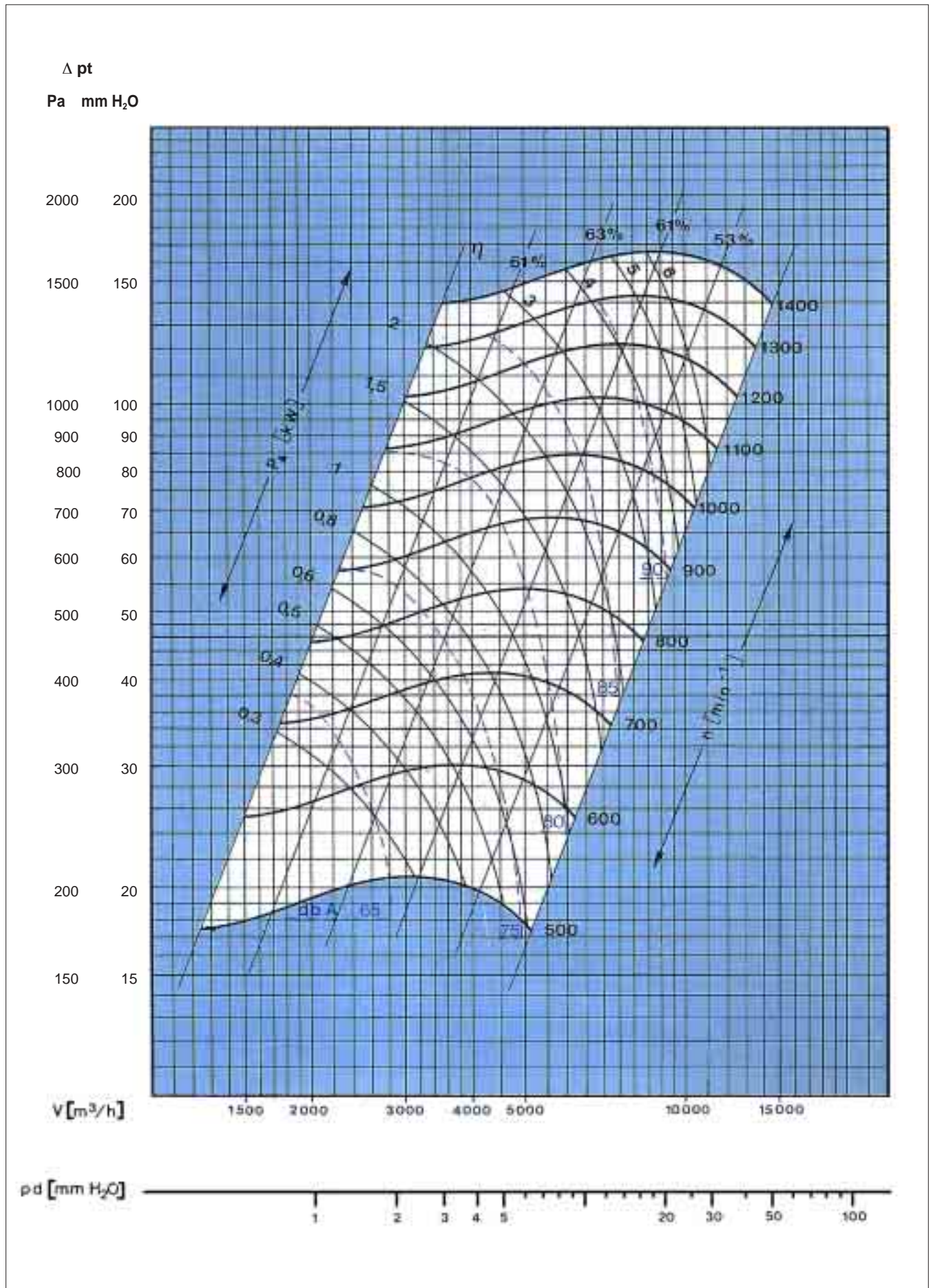

VERTICAL OUTPUT

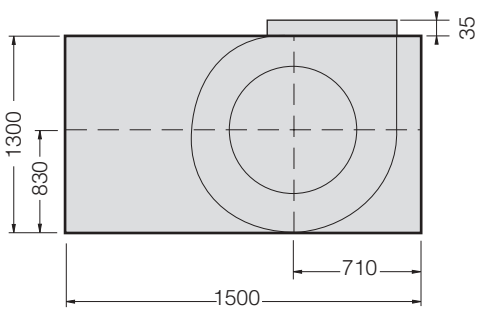

SALIDA VERTICAL

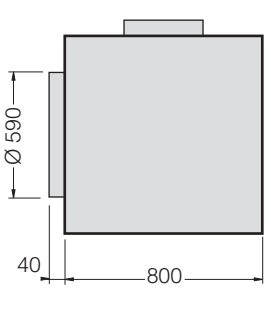

SORTIE VERTICALE

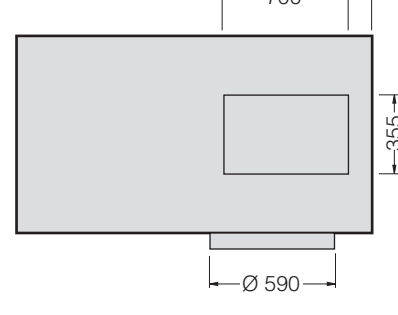

IZQ. NORMAL
LEFT STANDARD
GAUCHE NORMALE



DER. (BAJO PEDIDO)
RIGHT (TO ORDER)
DROITE (SUR COMMANDE)

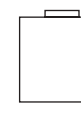

PESO: 178 Kgs. (SIN MOTOR)
WEIGHT: 178 Kgs. (WITHOUT MOTOR)
POIDS: 178 Kgs. (SANS MOTEUR)

HORIZONTAL OUTPUT

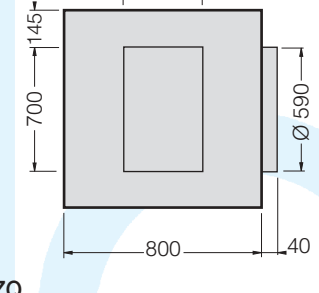

SALIDA HORIZONTAL

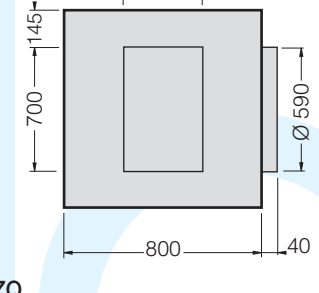

SORTIE HORIZONTALE

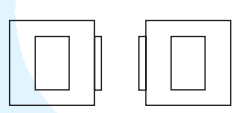

IZQ. NORMAL
LEFT STANDARD
GAUCHE NORMALE

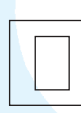

DER. (BAJO PEDIDO)
RIGHT (TO ORDER)
DROITE (SUR COMMANDE)

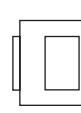

PESO: 178 Kgs. (SIN MOTOR)
WEIGHT: 178 Kgs. (WITHOUT MOTOR)
POIDS: 178 Kgs. (SANS MOTEUR)

VENTILADOR M.S.O.

MODELO 22/11

M.S.O. FAN / VENTILATEUR M.S.O.

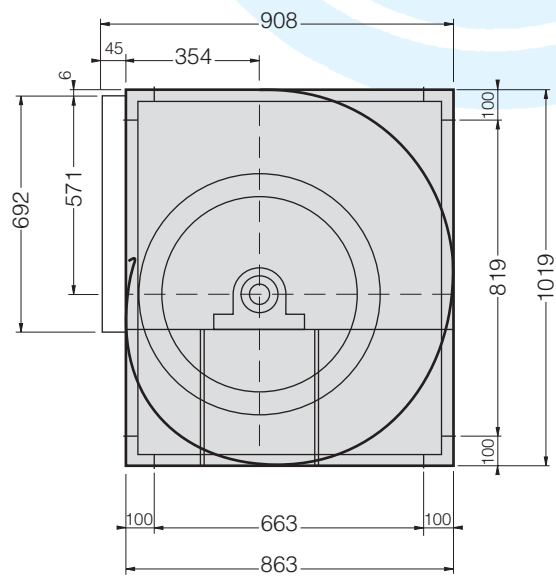

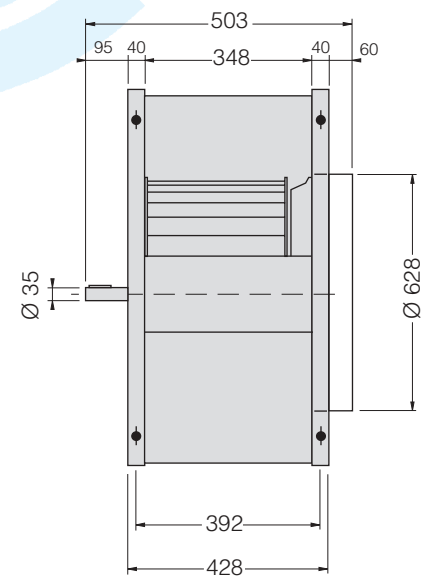

PESO: 75 Kgs.
WEIGHT: 75 Kgs.
POIDS: 75 Kgs.

GRAFICO DE CURVAS DE RENDIMIENTO VENTILADOR SIMPLE ASPIRACION TIPO M.S.O. 22/11

PERFORMANCE CURVE GRAPH. SIMPLE SUCTION FAN M.S.O. 22/11 TYPE / GRAPHIQUE DE COURBES DE RENDEMENT VENTILATEUR D'ASPIRATION SIMPLE TYPE M.S.O. 22/11

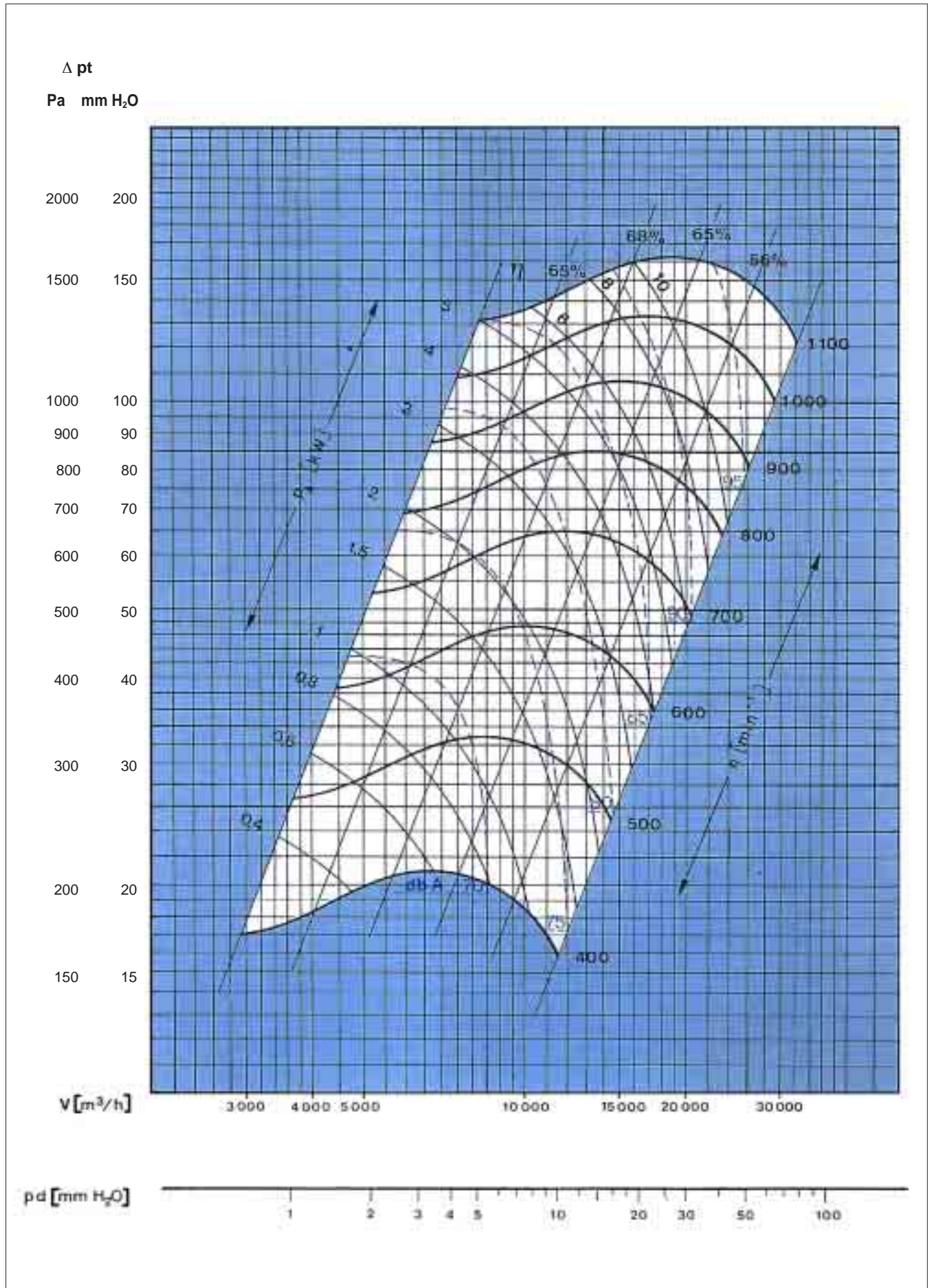

VERTICAL OUTPUT

SALIDA VERTICAL

SORTIE VERTICALE

IZQ. NORMAL
LEFT STANDARD
GAUCHE NORMALE

DER. (BAJO PEDIDO)
RIGHT (TO ORDER)
DROITE (SUR COMMANDE)

PESO: 208 Kgs. (SIN MOTOR)
WEIGHT: 208 Kgs. (WITHOUT MOTOR)
POIDS: 208 Kgs. (SANS MOTEUR)

HORIZONTAL OUTPUT

SALIDA HORIZONTAL

SORTIE HORIZONTALE

IZQ. NORMAL
LEFT STANDARD
GAUCHE NORMALE

DER. (BAJO PEDIDO)
RIGHT (TO ORDER)
DROITE (SUR COMMANDE)

PESO: 208 Kgs. (SIN MOTOR)
WEIGHT: 208 Kgs. (WITHOUT MOTOR)
POIDS: 208 Kgs. (SANS MOTEUR)

PESO: 89 Kgs.
WEIGHT: 89 Kgs.
POIDS: 89 Kgs.

GRAFICO DE CURVAS DE RENDIMIENTO VENTILADOR SIMPLE ASPIRACION TIPO M.S.O. 25/12,5

PERFORMANCE CURVE GRAPH. SIMPLE SUCTION FAN M.S.O. 25/12,5 TYPE / GRAPHIQUE DE COURBES DE RENDEMENT VENTILATEUR D'ASPIRATION SIMPLE TYPE M.S.O. 25/12,5

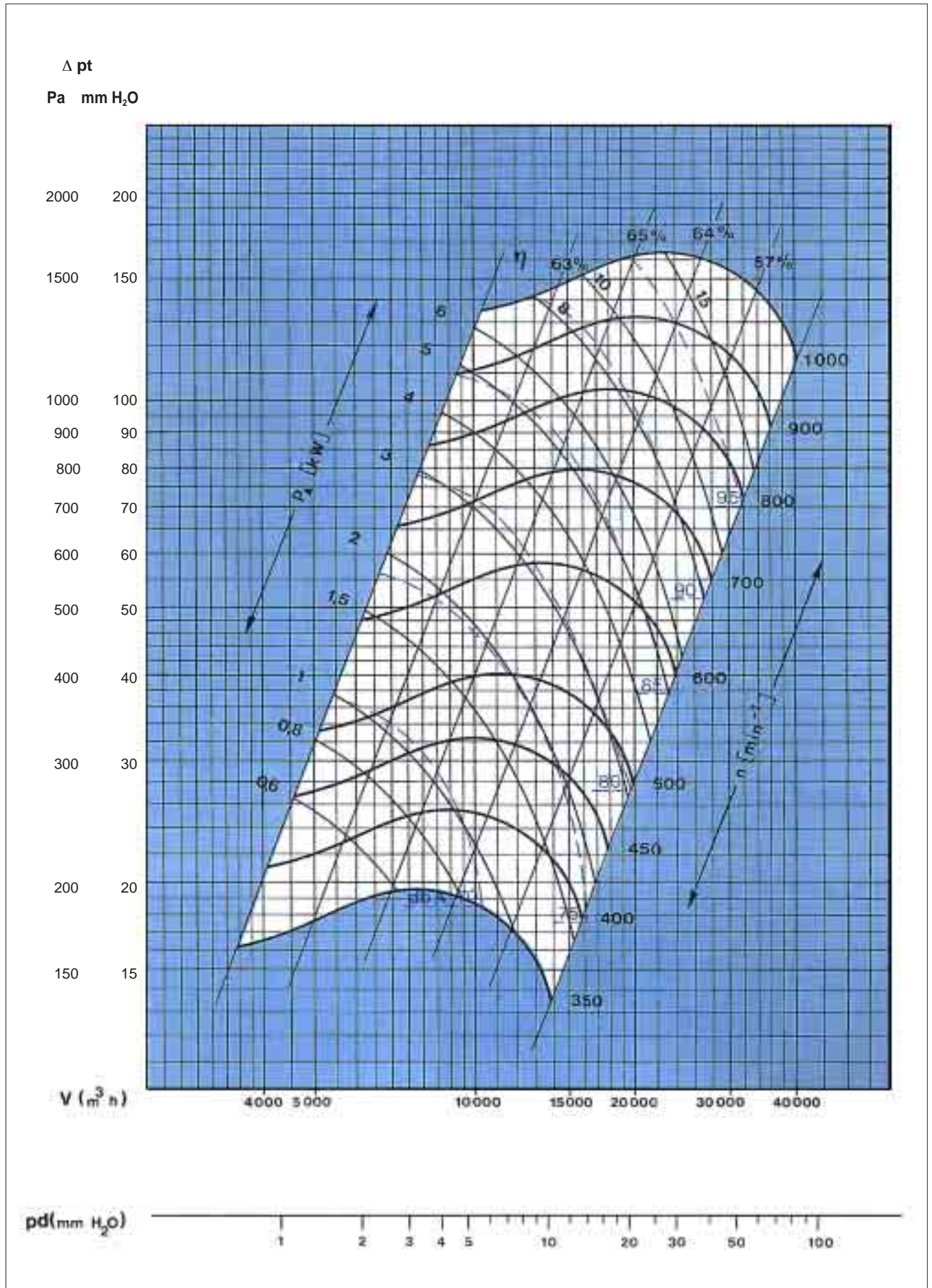

VERTICAL OUTPUT

SALIDA VERTICAL

SORTIE VERTICALE

IZQ. NORMAL
LEFT STANDARD
GAUCHE NORMALE

DER. (BAJO PEDIDO)
RIGHT (TO ORDER)
DROITE (SUR COMMANDE)

PESO: 268 Kgs. (SIN MOTOR)
WEIGHT: 268 Kgs. (WITHOUT MOTOR)
POIDS: 268 Kgs. (SANS MOTEUR)

HORIZONTAL OUTPUT

SALIDA HORIZONTAL

SORTIE HORIZONTALE

IZQ. NORMAL
LEFT STANDARD
GAUCHE NORMALE

DER. (BAJO PEDIDO)
RIGHT (TO ORDER)
DROITE (SUR COMMANDE)

PESO: 268 Kgs. (SIN MOTOR)
WEIGHT: 268 Kgs. (WITHOUT MOTOR)
POIDS: 268 Kgs. (SANS MOTEUR)

PESO: 120 Kgs.
WEIGHT: 120 Kgs.
POIDS: 120 Kgs.

GRAFICO DE CURVAS DE RENDIMIENTO VENTILADOR SIMPLE ASPIRACION TIPO M.S.O. 30/14

PERFORMANCE CURVE GRAPH. SIMPLE SUCTION FAN M.S.O. 30/14 TYPE / GRAPHIQUE DE COURBES DE RENDEMENT VENTILATEUR D'ASPIRATION SIMPLE TYPE M.S.O. 30/14

