

# Catálogo de herrajes corredera en linea PVC

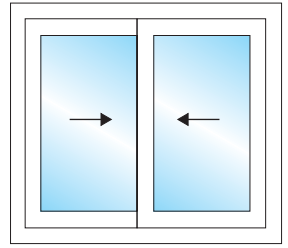

2

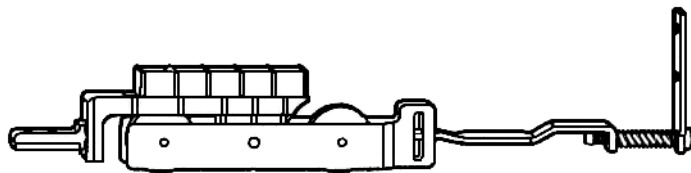

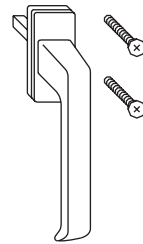
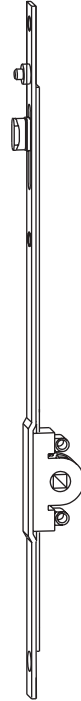

	<b>Página</b>
Accesorios	2-4
Manillas “DIRIGENT” y accesorios	2-5
Manillas varias de ventana	2-6
Cremonas y cerraderos según perfil	2-7
Ruedas fijas ; regulables y tandems.	2-8
Cremonas Corredera en línea E 7,5	2-9
Cremonas Corredera en línea E 15	2-10
Cremona Corredera en línea E 15 (Con agujero para cilindro)	2-11
Cierre de hoja pasiva	2-12
Cremona corredera en línea (especial) Entrada 25 mm con agujero para cilindro	2-13
Cremona corredera en línea (especial) Entrada 30.	2-14
Ruedas y tandems para corredera	2-15

## INFORMACIÓN DE PRODUCTO

### Herrajes correderos en línea para puertas y ventanas de PVC

#### Aplicación

Campo de aplicación para los herrajes correderos en línea:

- Puertas correderas de 1 hasta 2 bastidores
- Ventanas correderas de 1 hasta 2 bastidores.

#### Diseños

##### Cremona

Por causa de su construcción según el principio de las cremonas JET, la cremona para bastidores correderos en línea se adapta en los perfiles con ranura oscilo-batiente normal. Una caja de acero está soldada en la pletina. Cierre por bulones de cierre y un bulón de seguro antielevación.

##### Cremona de cierre con agujero para cilindro

El montaje de esta cremona de cierre permite cerrar las puertas correderas en línea con llave. Como la cremona normal ella está prevista de bulones de cierre y un bulón de seguro antielevación.

#### Cerraderos

Cerraderos de cierre de acero galvanizado y bicromatizado, opcionalmente lacados, para un cierre seguro del bastidor en el marco

#### Ruedas

Las ruedas adaptadas a los diversos sistemas de perfiles están previstas de cojinetes de agujas autolubrificantes para un movimiento fácil de los bastidores correderos.

#### Variantes:

- Ruedas de zinc moldeado bajo presión para bastidores hasta 40 Kg.
- Ruedas de zinc moldeado bajo presión (con o sin regulación de altura) para bastidores hasta 80 Kg.
- Ruedas de acero con rodillos (con o sin regulación) para bastidores hasta 120 Kg o 100 Kg fresando la ranura de la hoja.

#### Materiales, protección contra la oxidación

Las piezas de los herrajes están fabricadas de aleaciones de acero o de zinc moldeado bajo presión de alta calidad, galvanizadas y bicromatizadas; tratamiento superficial FerGUard plata.

#### Abreviaciones

- BC Bulones de cierre medio.
- G Posición de manilla, cota constante.

#### Referencias de pedido

Ejemplo

Referencia

G-15386-10-0-1

- G-15386- - - Número de la pieza
- -10- - Tamaño
- - -L- DIN izquierda
- - -R- DIN derecha
- - -0- Utilizable en ambos lados
- - -4- Cremona con sujetamanillas
- - - -1 color plata (FerGUard) / Anodizado EV 1
- - - -2 color champan Ev2
- - - -3 Anodizado F3 / color latón
- - - -7 Color blanco
- - - -\* Tratamiento de superficie variable (ver lista de precios)

2

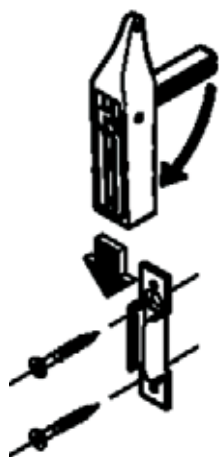

Manilla articulada de quita y pon  
Blanca: E-18333-00-0-7  
Marrón: E-18333-00-0-5

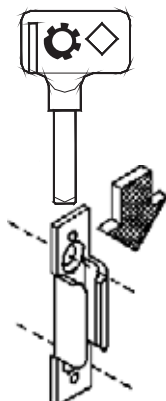

Manilla de quita y pon  
E-18331-PR-0-0



Roseta Quita y pon plana.  
Blanca: G-46231-00-0-7  
Negra: G-46231-00-9005

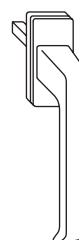

Manilla Dirigent  
6-28072-29-0-\*



Bolsa de tope 90  
Blanco: K-12024-00-0-7  
Negro: K-12024-00-0-6



Cerraderos  
E-13880-00-0-1  
E-13880-04-0-1  
E-13880-06-0-1  
G-16720-09-0-1  
G-16720-05-0-1  
G-17722-00-0-1



Accionamiento interior  
Tornillo avellanado  
M5x25 9-13255-25  
M5x30 9-13255-30  
M5x35 9-13255-35  
M5x40 9-13255-40

Cremonas corredera para perfiles sin canal herraje 16 mm

Seguro Anti-elevación  
E-18196-00-0-1

Calce de cerradero

Cerradero



Cremona E 7,5

Cremona E 7,5

Cremona E 15

Calce de cerradero

Cerradero

Herrajes necesarios

Cant.	Denominación	Referencia
1	Cremona Entrada 7,5	
	Long. N°Bulones Cota Manilla	
	125 1 --	G-19505-09-0-1
	550 2 275	G-21781-05-0-1
	1800 3 900	G-21781-18-0-1

Herrajes necesarios

Cant.	Denominación	Referencia
1	Cremona Entrada 15	
	Long. N°Bulones Cota Manilla	
	590 2 295	G-21782-05-0-1
	1800 3 900	G-21782-18-0-1

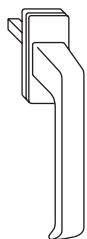

DIRIGENT-F  
Cuadradillo 29  
6-28072-29-0-\*  
Cuadradillo 33  
6-28072-33-0-\*  
Cuadradillo 38  
6-28072-38-0-\*

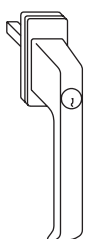

DIRIGENT-F/Z con  
cilindro de presión,  
llaves iguales  
Cuadradillo  
33: 6-28075-33-0-\*  
Cuadradillo 38  
38: 6-28075-38-0-\*

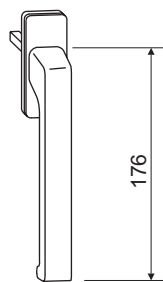

DIRIGENT GRANDE  
Blanca: 6-31382-40-0-7  
Negra: 6-31382-40-0-6  
Plata: 6-31382-40-0-11

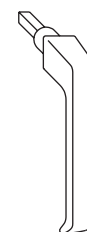

DIRIGENT-F/SG  
de quita y pon  
Cuadradillo 33  
8-00694-33-0-\*  
\*Colores disponibles:  
1-Plata  
7-Blanco

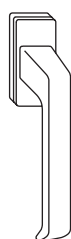

DIRIGENT-F  
sin cuadradillo  
6-28072-00-0-\*



DIRIGENT-F/AF  
exterior – plana  
6-25223-00-0-\*

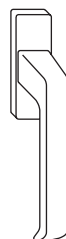

DIRIGENT-F/A  
exterior  
6-25993-00-0-\*

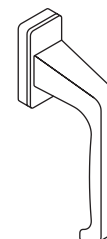

DIRIGENT-F/H  
de cuello alto,  
sin cuadradillo  
6-28102-00-0-\*

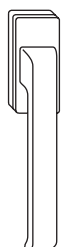

DIRIGENT-F interior,  
sin cuadradillo  
6-28101-00-0-\*



Roseta/F  
interior – plana  
6-24913-00-0-\*

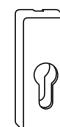

Roseta PZ  
interior  
6-25224-02-0-\*



Roseta PZ/A  
exterior  
9-32407-02-0-\*

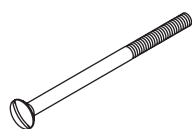

Tornillo, rosca 24 mm  
M 4 x 66 9-26881-56  
M 4 x 90 9-26881-81



Tuerca  
Longitud 22 mm  
9-26882



Accionamiento interior y  
exterior  
Tornillo avellanado  
M5x25 9-13255-25  
M5x30 9-13255-30  
M5x35 9-13255-35  
M5x40 9-13255-40  
M5x45 9-13255-45  
M5x60 9-13255-60 (FD 56-60)  
M5x70 9-13255-70 (FD 61-70)  
M5x80 9-13255-80 (FD 71-80)

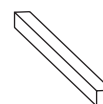

Cuadradillo 7x131  
FD 56-80  
9-26874-69-0-1



Tirador exterior  
9-22921-00-0-\*

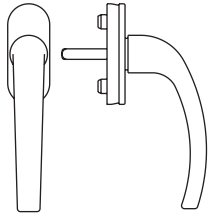

Manilla MODENA  
6-31977-29-0-\* (Acabados 1,7,5, y 3)  
6-31977-33-0-\* (Acabados 1,7,5,6 y 3)  
6-31977-38-0-\* (Acabados 11,7 y 5)  
\* Colores: 7;Blanco, 5; Marrón ,6; Negro  
3; Dorado F3 y 1 ó 11 Plata.

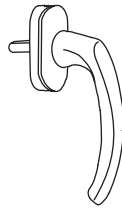

Manilla "LUXEMBURGO"  
cuadradillo 7 x 32  
Blanca; 8061988-BLANCO  
Marrón; 8062002-MARRON  
Plata; 8061822-PLATA  
  
cuadradillo 7 x 38  
Blanca; 2112698-BLANCO  
Marrón; 2266814-MARRON  
Plata; 2112701-PLATA



Manilla ventana Latón  
cuadradillo 7x32  
M061/U11N10AF71

2

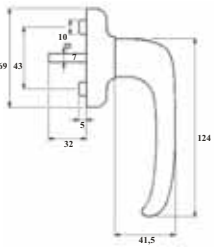

Manilla DISEÑO  
Cuadradillo 7x32:  
827210 Blanca  
828210 Negra  
824210 Dorada (oro)  
Cuadradillo 7x38:  
CR0210B387 Blanca  
CR0210B388 Negra



Manilla 1290 Latón  
cuadradillo 7x33  
R-1290L-33-0-3

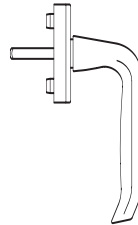

Manilla ADAGIO Latón  
cuadradillo 7x35  
070490

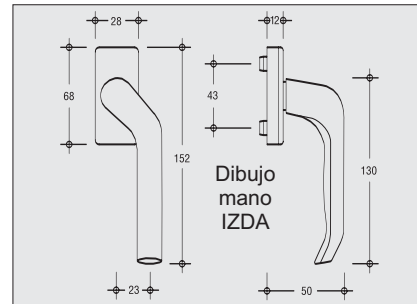

▲ Manilla ADAGIO Acodada  
sin cuadradillo  
6-31221-00-0-\* Mano Dcha  
6-31323-00-0-\* Mano Izda  
\* 7 Blanco ; 5 Marrón

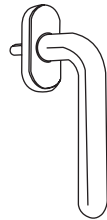

Manilla INOX "ORFEO"  
cuadradillo 7x33  
B-7290-6012

Manillas escudo estrecho (acodadas y recta)  
cuadradillo 7x40

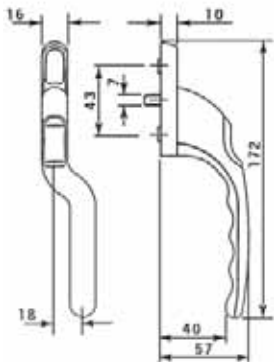

Manilla Acodada Derecha  
Ref. 0141-02R-BLANCO  
0141-02R-NEGRO

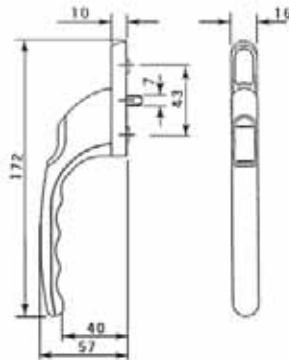

Manilla Recta  
Ref. 0139-00-BLANCO  
0139-00-NEGRO

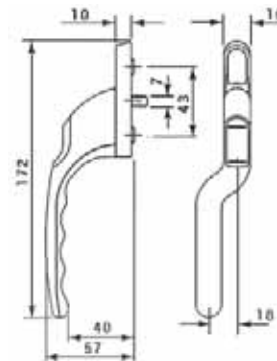

Manilla Acodada Izquierda  
Ref. 0141-01L-BLANCO  
0141-01L-NEGRO

# Cremonas y cerraderos según perfil. Herrajes correderos en línea para ventanas y puertas de PVC

**Tabla de visión del conjunto**

Sistema de perfiles	Cremona	Cremona de cierre con agujero para cilindro	Cerradero	Cerradero para bulón de seguro contra desquicie	Ruedas (Ver pag 2-8)
<b>Alphacan PFS mini</b> Hoja E4108 Marco E4109	G-15383-**-0E1		E-13880-00-0-1	E-18196-00-0-1	
<b>Alphacan PFS</b> Hoja E4101 Marco E4102	G-15383-**-0E1		E-13880-00-0-1	E-18196-00-0-1	
<b>Alphacan PZ</b> Hoja PZ 444 Marco PZ 445	G-20381-16-0-1 (Entrada 30 mm)	G-18250-16-0-1 (Entrada 25 mm)	E-13880-00-0-1	E-18196-00-0-1	
<b>Aluplast Serie S73</b> Hoja 150.032 Marco 150.030	G-13954-**-4A1	G-15386-10-0-1	E-13880-04-0-1	E-18196-00-0-1	
<b>Deceuninck Tecnocor (ventana)</b> Hoja 2460 Marco 2450	G-15383-**-0E1		E-13880-00-0-1	E-18196-00-0-1	
<b>Deceuninck Tecnocor (puerta)</b> Hoja 2465 Marco 2450	G-13954-**-4A1	G-15386-10-0-1	E-13880-00-0-1	E-18196-00-0-1	
<b>Deceuninck Tecnocor 2</b> Hoja 3460 Marco 3483	G-15383-**-0E1		G-20075-00-0-1	E-18196-00-0-1	
<b>Deceuninck Tecnocor 2</b> Hoja 3465 Marco 3483	G-13954-**-4A1	G-15386-10-0-1	G-20075-00-0-1	E-18196-00-0-1	
<b>Soprofen SR1-SF1</b>	G-15383-**-0E1 + placa de apriete E-15675-00-0-1		E-13880-00-0-1	E-18196-00-0-1	
<b>Gealan (puerta)</b> Hoja 2085 Marco 2029	G-15383-**-0E1		E-13880-04-0-1	E-18196-00-0-1	
<b>Gealan (ventana)</b> Hoja 2085 Marco 2029	G-15383-**-0E1		E-13880-04-0-1	E-18196-00-0-1	
<b>KBE-URSSA</b> Hoja 710 Marco 700	G-13954-**-4A1	G-15386-10-0-1	E-13880-04-0-1	E-18196-00-0-1	
<b>Kömerling SF2</b> Hoja 1386 Marco 1385	G-15383-**-0E1	G-18525-16-0-1	E-18524-00-L/R-1		
<b>Kömerling SF3</b>	G-19505-09-0-1		E-13880-04-0-1	E-18196-00-0-1	
<b>Rehau S 717 (Ventana)</b> Hoja 557090 Marco 557070	G-15383-**-4A1		E-13880-00-0-1	E-18196-00-0-1	
<b>Rehau S 717 (Puerta)</b> Hoja 557100 Marco 557070	G-13954-**-4A1	G-15386-10-0-1	E-13880-04-0-1	E-18196-00-0-1	
<b>Salamander (Ventana)</b> Hoja 601.025 Marco 600.025	G-15383-**-0E1		E-13880-06-0-1	E-18196-00-0-1	
<b>Salamander (Puerta)</b> Hoja 601.030 Marco 600.030	G-13954-**-4A1	G-15386-10-0-1	E-13880-06-0-1	E-18196-00-0-1	
<b>Sisperfil</b>	G-15383-**-0E1		E-13880-00-0-1	E-18196-00-0-1	
<b>Schüco serie S73</b> Hoja Marco	G-13954-**-4A1	G-15386-10-0-1	E-13880-04-0-1	E-18196-00-0-1	
<b>Schüco serie S74</b>	G-13954-**-4A1	G-15386-10-0-1	E-13880-04-0-1	E-18196-00-0-1	
<b>Thyssen SR1-SF1</b>	G-15383-**-0E1 + placa de apriete E-15675-00-0-1		E-13880-00-0-1	E-18196-00-0-1	
<b>Thyssen Patio door</b>	G-13954-**-4A1	G-15386-10-0-1	G-16720-05-0-1	E-18196-00-0-1	
<b>Trocal (ventana)</b> Hoja 925 600 Marco 915 100	G-15383-**-0E1		G-16720-09-0-1	E-18196-00-0-1	
<b>Trocal (puerta)</b> Hoja 525 500 Marco 915 100	G-13954-**-4A1	G-15386-10-0-1	G-16720-09-0-1	E-18196-00-0-1	
<b>Veka Ekosol (ventana)</b> Hoja 105240 Marco 105245	G-15383-**-0E1		E-13880-06-0-1	E-18196-00-0-1	
<b>Veka Ekosol (puerta)</b> Hoja 105241 Marco 105245	G-13954-**-4A1	G-15386-10-0-1	E-13880-06-0-1	E-18196-00-0-1	

	PESO MÁXIMO POR RUEDA	PERFIL	VEKA	KÖMM	DECEUNINCK	KBE-URSSA	REHAU	TROCAL	ALUPLAST	SCHÜCO	THYSSEN	SOPROFEN	ALPHACAN	ALPHACAN	ALPHACAN	ALPHACAN	SALAMAND.	SISTPERFIL	937	934	
																					RUEDA
RUEDAS FIJAS	20	101-001-01-0-1																			
	16	101-001-KO-1																			
	30	101-002-01-0-1																			
	30	101-003-01-0-1																			
	30	101-003-02-0-1																			
	50	101-004-01-0-1																			
	50	101-005-01-0-7																			
	40	101-006-01-0-1																			
	40	101-007-01-0-7																			
	50	E-00363-PL-A																			
	40	G-15063-00-0-0																			
	40	G-15202-00-0-0																			
	20	G-15674-00-0-1																			
	20	G-16822-10-0-0																			
	40	G-16824-00-0-0																			
	40	G-16881-00-0-0																			
	30	K-00350																			
	20	VK-43+																			
	RUEDAS REGULABLES	40	G-14320-00-0-0																		
		40	G-15065-00-0-0																		
40		G-16823-00-0-0																			
40		G-16880-00-0-0																			
25		G-19787-01-0F6																			
60		G-19797-06-0F6																			
60		G-19797-07-0F6																			
60		G-19797-09-0F6																			
60		G-19797-20-0F6																			
60		G-19797-17-0-6																			
80		GT-103/3-AL-M																			
60		G-19797-23-0F6																			
25		G-19787-01-0F6																			
40		C-90106-03-0-1																			

■ RUEDA SIN FRESAR EL PERFIL

☒ RUEDA FRESANDO EL PERFIL

\* Para Kömmerling SF2 (hoja 1386 ó 1391) se necesita el calce C-70108-03-0-7



Seguro Anti-elevación  
E-18196-00-0-1



Cerradero



**Herrajes necesarios**

Cant.	Denominación	Referencia
1	Cremona Entrada 7,5	
	Long. N°Bulones Cota Manilla	
	125 1 --	G-19505-09-0-1
	600 2 300	G-15383-06-0E1
	1000 2 500	G-15383-10-0E1
	1800 3 900	G-15383-18-0E1
1,2 ó 3	Cerradero Standard	E-13880-00-0-1
1	Seguro Anti-elevación	E-18196-00-0-1

2

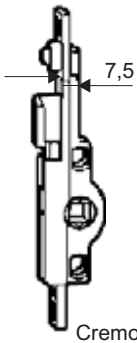

Cremona E 7,5

Cremona E 7,5

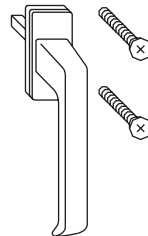

Manilla Dirigent  
6-28072-29-0-\*  
Tornillo Manilla  
9-13255-35



Roseta de quita y pon plana  
Blanca G-46231-00-0-7  
Negra: G-46231-00-9005

Manilla quita y pon  
E-18331-PR-0-0

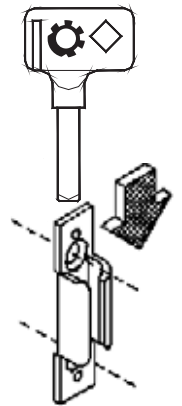

Cerradero  
E-13880-00-0-1



Cerradero



Ruedas  
(ver pág. 2-8)

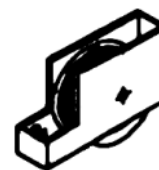

Seguro Anti-elevación  
E-18196-00-0-1

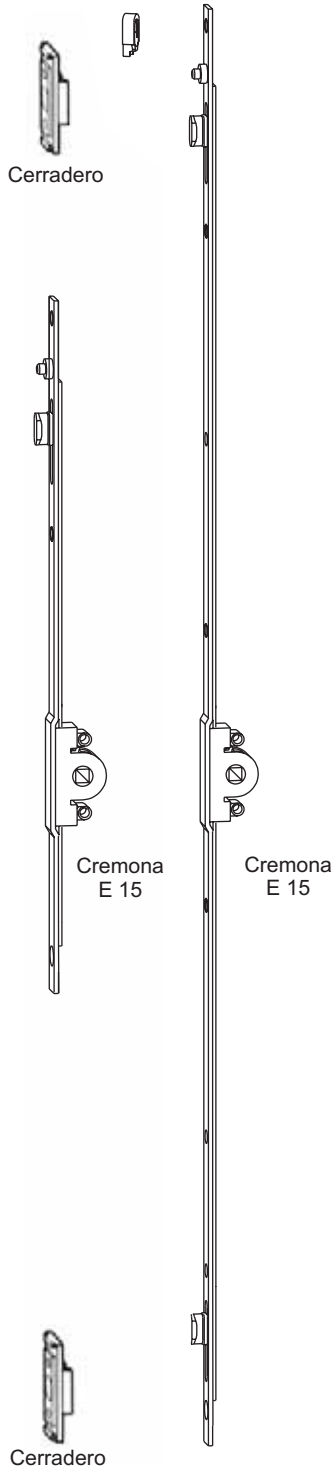

**Herrajes necesarios**

Cant.	Denominación	Referencia
1	Cremona Entrada 15	
	Long. N°Bulones Cota Manilla	
	300 1 110	G-13954-03-4A1
	600 2 300	G-13954-06-4A1
	1000 2 500	G-13954-10-4A1
	1600 2 800	G-13954-16-4A1
	1800 3 900	G-13954-04-4A1
1,2 ó 3	Cerradero Standard	E-13880-00-0-1
1	Seguro Anti-elevación	E-18196-00-0-1

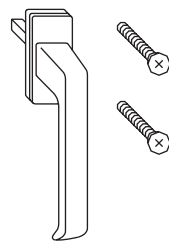

Manilla Dirigent  
6-28072-29-0-\*  
Tornillo Manilla  
9-13255-35



Roseta de quita y pon plana  
Blanca G-46231-00-0-7  
Negra: G-46231-00-9005

Manilla quita y pon  
E-18331-PR-0-0

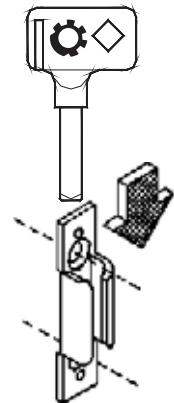

Cerradero  
E-13880-00-0-1

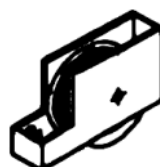

Ruedas  
(ver pág. 2-8)

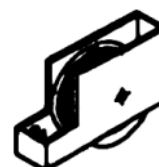

## Herrajes necesarios

Cant.	Denominación	Referencia
1	Cremona de cierre con agujero para cilindro, Entrada 15.	
<b>Perfiles</b>		
(1)	Long. 1600 N°Bulones 2 Cota 800 Manilla	G-15386-10-0-1
(2)	Long. 1600 N°Bulones 4 Cota 715 Manilla	G-18525-16-0E1
(1)	Resto perfiles - Entrada 15	
(2)	Kömmerling - Entrada 9	

Seguro Anti-elevación  
E-18196-00-0-1

Cerradero según perfil

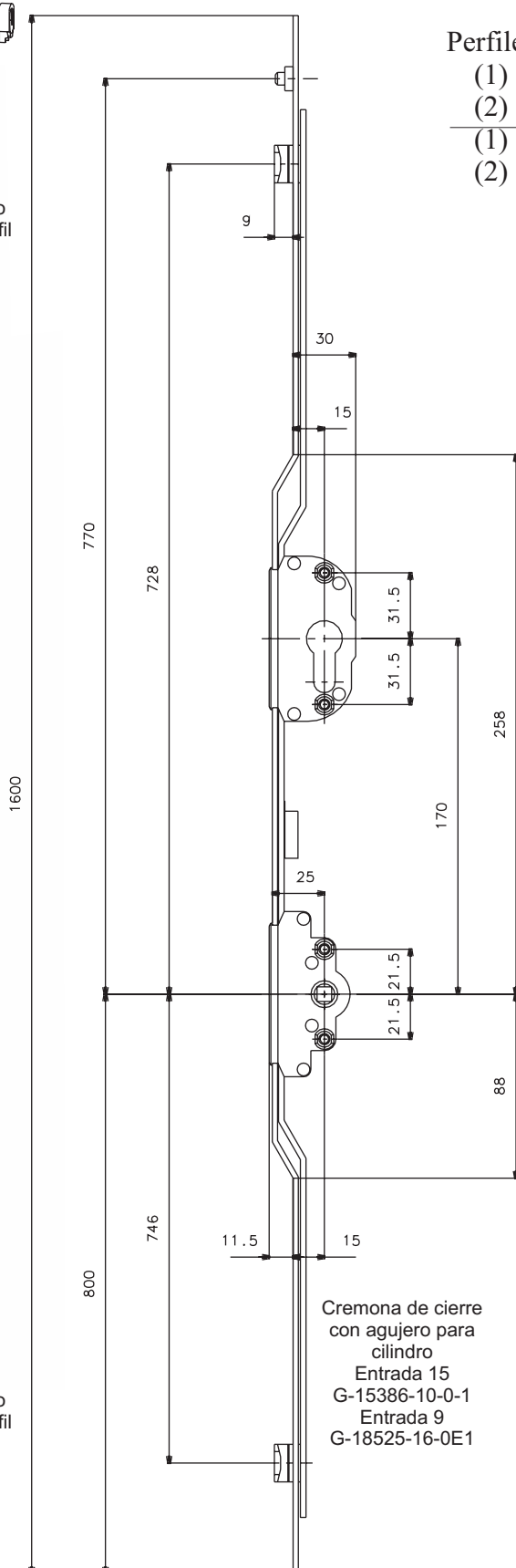

Cremona de cierre con agujero para cilindro  
Entrada 15  
G-15386-10-0-1  
Entrada 9  
G-18525-16-0E1

Cerradero según perfil



Roseta PZ interior  
6-25224-02-0\*



Roseta PZ/A exterior  
9-32407-02-0\*

Tornillo avellanado  
M5x80 9-13255-80

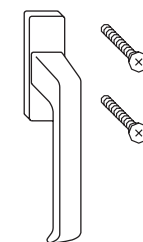

DIRIGENT-F exterior  
6-25993-00-0\*  
Tornillo avellanado  
M 5 X 80  
9-13255-80

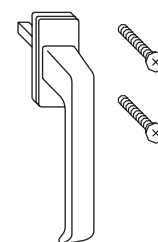

DIRIGENT-F Cuadrillo 29  
6-28072-29-0\*  
Tornillo avellanado  
M5 X 35  
9-13255-35

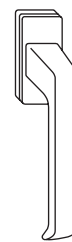

DIRIGENT-F interior, sin cuadrillo  
6-28072-00-0\*

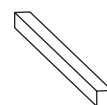

Cuadrillo 7x131  
FD 56-80 9-26874-69

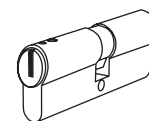

Cilindro serie 8800 (niquelado)  
31/31 B-8800-0101  
35/35 B-8800-5237

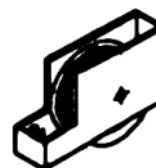

Ruedas  
(ver pág. 2-8)



**Herrajes necesarios**

Cant.	Denominación	Referencia
1	Cierre de bastidor pasivo	
	Long. N°Bulones Cota Manilla	
	600 2 300	G-17000-06-0-7
	1200 2 600	G-17000-12-0-7
2	Cerradero para cierre de bastidor pasivo Sistema de perfiles	
	Soprofen SR1-SF1	E-13880-00-0-1
	Kömmerling SF2	E-13880-00-0-1
	Thyssen SR1-SF1	E-13880-00-0-1
	Trocal	G-16720-14-0-7
	KBE-URSSA	E-13880-00-0-1

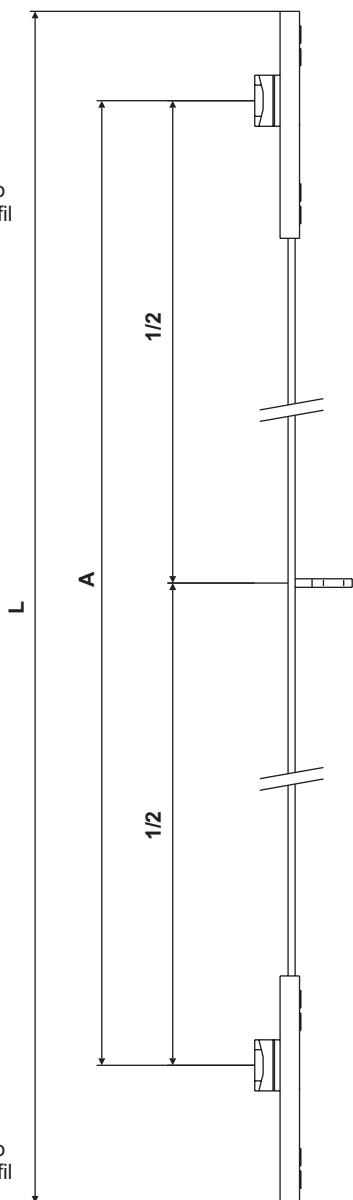

2

Cerradero según perfil

Cerradero según perfil

Cierre	L	A
G-17000-06-0-7	600	476
G-17000-12-0-7	1200	1076

# Cremonas corredera en linea (especial) Entrada 25 mm con agujero para cilindro ( para cerrar con llave ).

## Herrajes necesarios

Cant.	Denominación	Referencia
1	Cremona de cierre con agujero para cilindro, Entrada 25. Long. N°Bulones Cota Manilla	
1600	2 800	G-18250-16-0-1

Seguro Anti-elevación  
E-18196-00-0-1



Cerradero según perfil

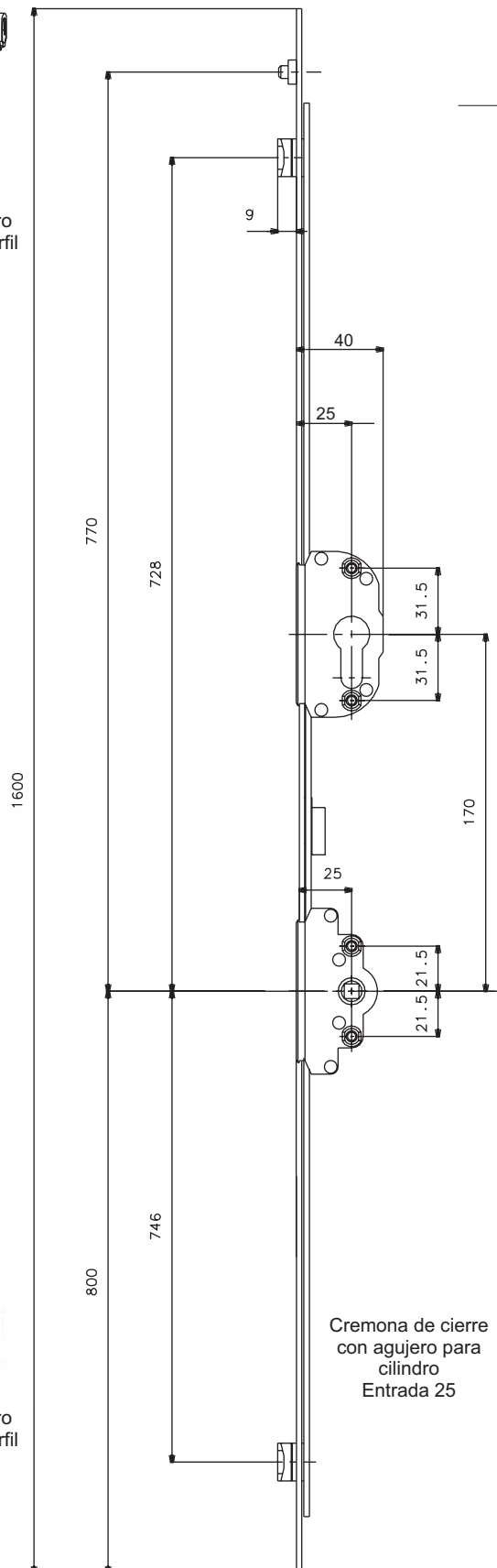

Cremona de cierre con agujero para cilindro Entrada 25

Cerradero según perfil

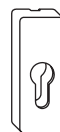

Roseta PZ interior  
6-25224-02-0-\*



Roseta PZ/A exterior  
9-32407-02-0-\*

Tornillo avellanado  
M5x80 9-13255-80



2

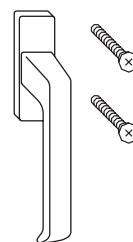

DIRIGENT-F exterior  
6-25993-00-0-\*

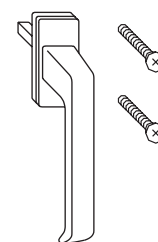

DIRIGENT-F Cuadrillo 29  
6-28072-29-0-\*

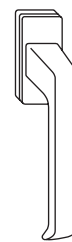

DIRIGENT-F interior, sin cuadrillo  
6-28072-00-0-\*

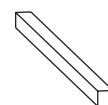

Cuadrillo 7x131  
FD 56-80 9-26874-69

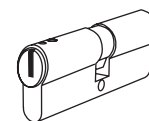

Cilindro serie 8800 (niquelado)  
31/31 B-8800-0101  
35/35 B-8800-5237



Ruedas  
(ver pág. 2-8)

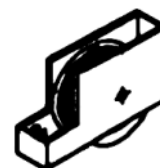

Seguro Anti-elevación  
E-18196-00-0-1



Cerradero  
E-13880-00-0-1



Cremona E30

**Herrajes necesarios**

Cant.	Denominación	Referencia
1	Cremona Entrada 30	
	Long. N°Bulones Cota Manilla	
	1600 2 800	G-20380-16-0-1
1,2 ó 3	Cerradero Standard	E-13880-00-0-1
1	Seguro Anti-elevación	E-18196-00-0-1

2

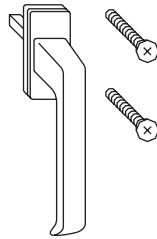

Manilla Dirigent  
6-28072-29-0-\*  
Tornillo Manilla  
9-13255-35



Roseta de quita y pon plana  
Blanca G-46231-00-0-7  
Negra: G-46231-00-9005

Manilla quita y pon  
E-18331-PR-0-0

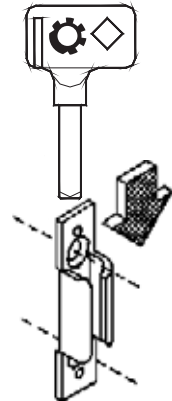

Cerradero  
E-13880-00-0-1

Cerradero  
E-13880-00-0-1

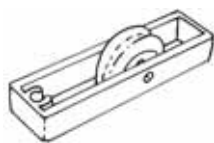

Rueda Fija ventana  
101-001-01-0-1  
101-002-01-0-1  
101-001-K0-1

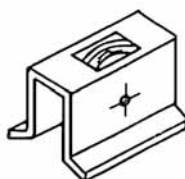

Rueda Fija ventana (Clipar)  
K-00350

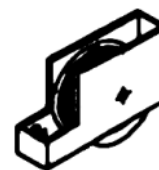

Rueda Fija Puerta  
101-003-01-0-1  
101-004-01-0-1  
101-006-01-0-1  
101-007-01-0-1

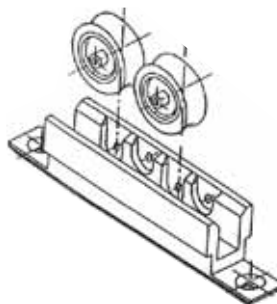

Tándem PVC  
ventana  
(2 posiciones Ruedas)  
VK-43+



Rueda Fija Ventana  
G-15674-00-0-1  
G-16822-10-0-1



Rueda fija Puerta  
G-15063-00-0-0  
G-15202-00-0-0  
G-16824-00-0-0  
G-16881-00-0-0

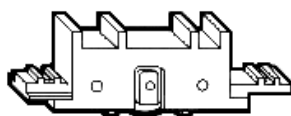

Rueda Regulable Puerta  
G-14320-00-0-0  
G-15065-00-0-0  
G-16823-00-0-0  
G-16880-00-0-0

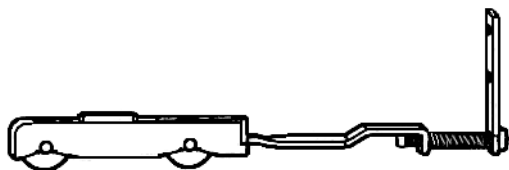

Tándem ROLL-LINE ventana  
G-19787-01-0F6

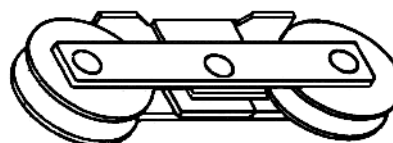

Tándem Fijo Puerta  
Corredera similar GU-937  
E-00363-PL-A

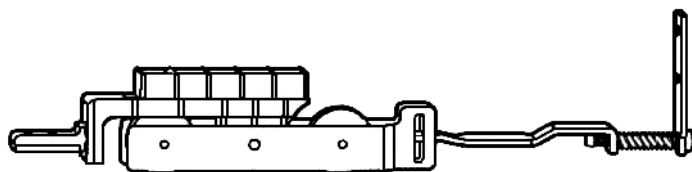

Tándem ROLL-LINE Puerta  
G-19797-06-0F6  
G-19797-07-0F6  
G-19797-09-0F6  
G-19797-17-0-6  
G-19797-20-0F6  
G-19797-23-0F6

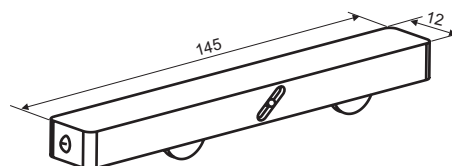

Tándem Regulable  
C-90106-03-0-1

