



Catálogo Técnico



Ventanas de uPVC

winbel



SERIE 3000

WIN 70

1.1) DESCRIPCION DEL SISTEMA

1. Junta Termosoldada premontada
2. Espesor de vidrio de 16 a 45 mm
3. Perfil vierteaguas
4. Canales para desagües
5. Deflectores cortavientos
6. Ranura para fijación de anclajes
7. Junquillo con junta extruñida en color blanco
8. Cámara para la colocación de refuerzos
9. Refuerzos en acero galvanizado
10. Canal de 13 mm para la colocación de herrajes mejorando los niveles de seguridad
11. Ranura para clipar junquillos y cerraderos
12. Mayor número de paredes interiores mejoram la fijación de bisagras
13. Mayor número de paredes interiores mejoram los índices de aislamiento térmico e acústico
14. Ranura para perfiles de unión
15. Mayor espesor de perfil
16. Recubrimiento de hoja sobre marco 8 mm
17. Pared de drenaje con inclinación hacia el exterior
18. Cantos redondeados
19. Calzo nivelador de hoja
20. Calzo para vidrio

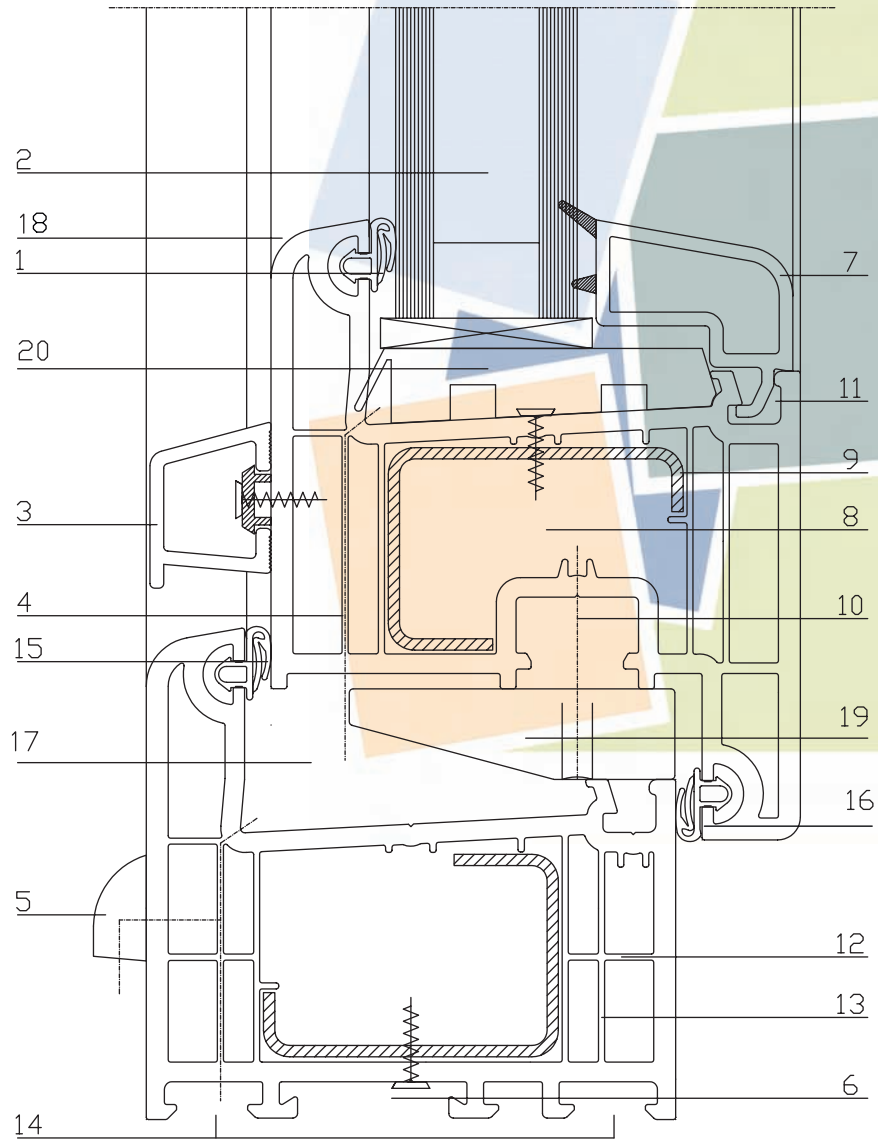

2) DIBUJO PERFILES

3001	MARCO
3100	TRAVESAÑO 87 mm

3001

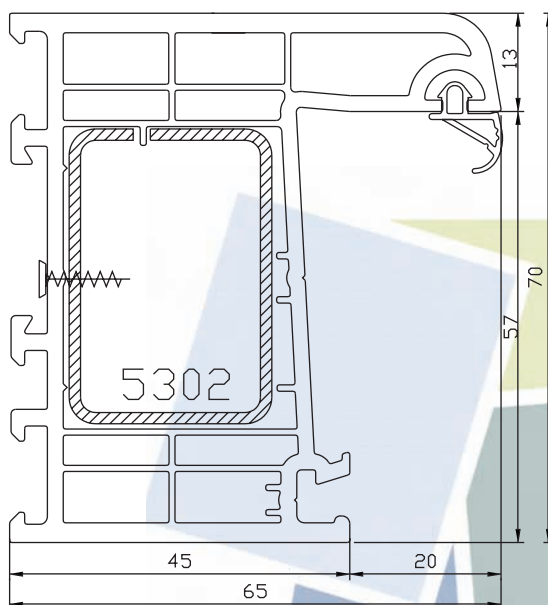

3100

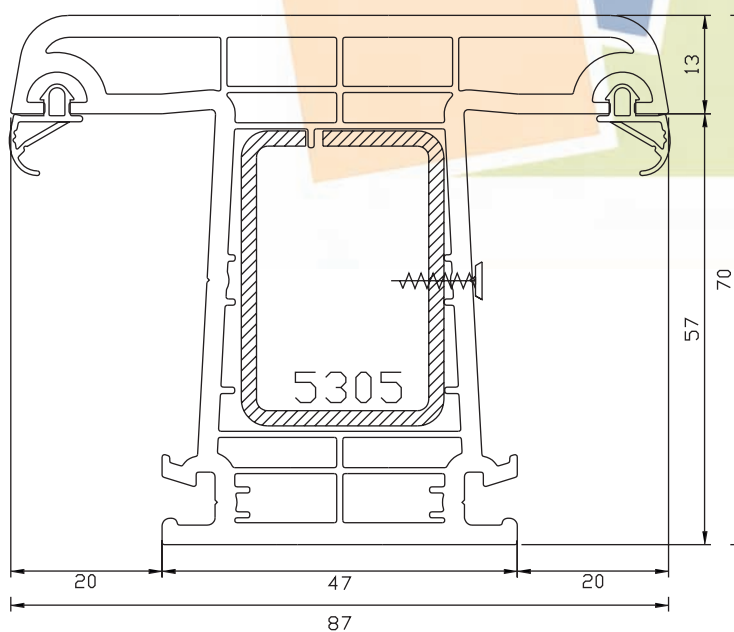

3201	HOJA
3300	INVERSOR

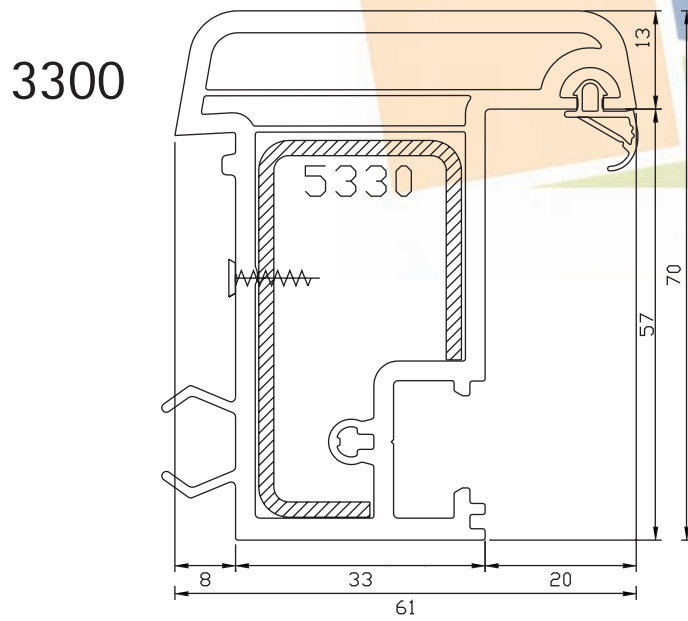
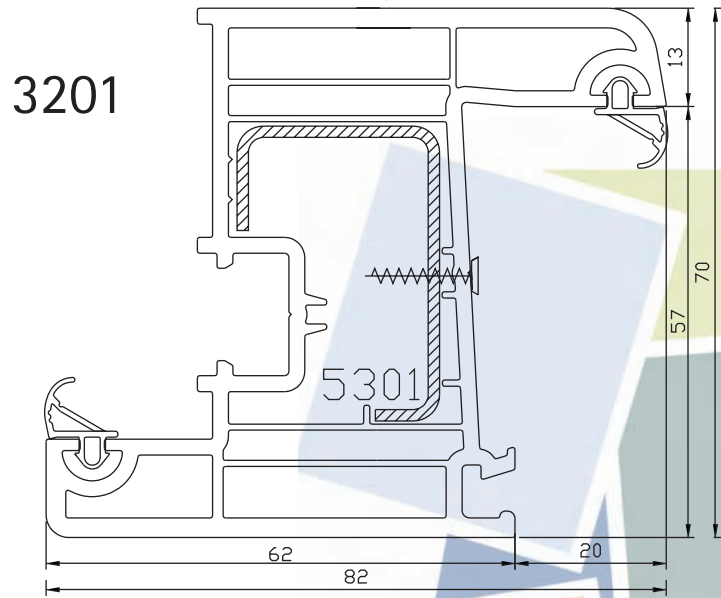

3203	HOJA DE PUERTA (INT.)
3204	HOJA DE PUERTA (EXT.)

3203

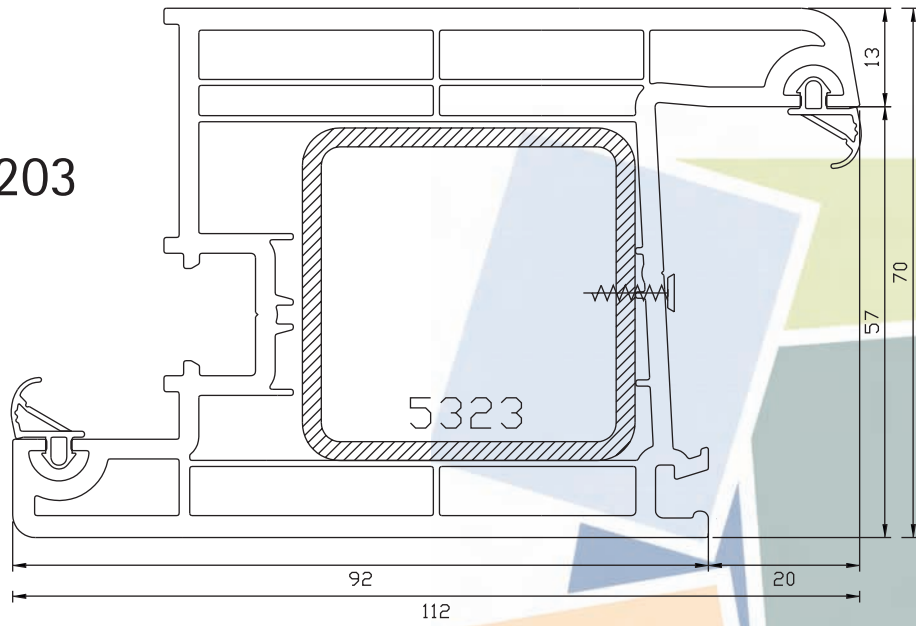

3204

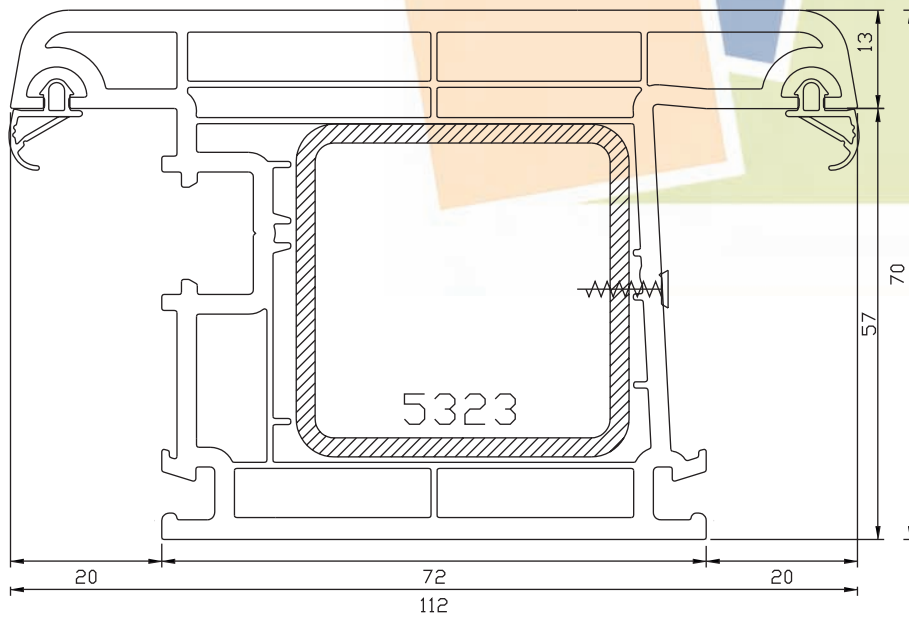

3424	JUNQUILLO VIDRIO 24 mm
2324	JUNQUILLO VIDRIO 34 mm

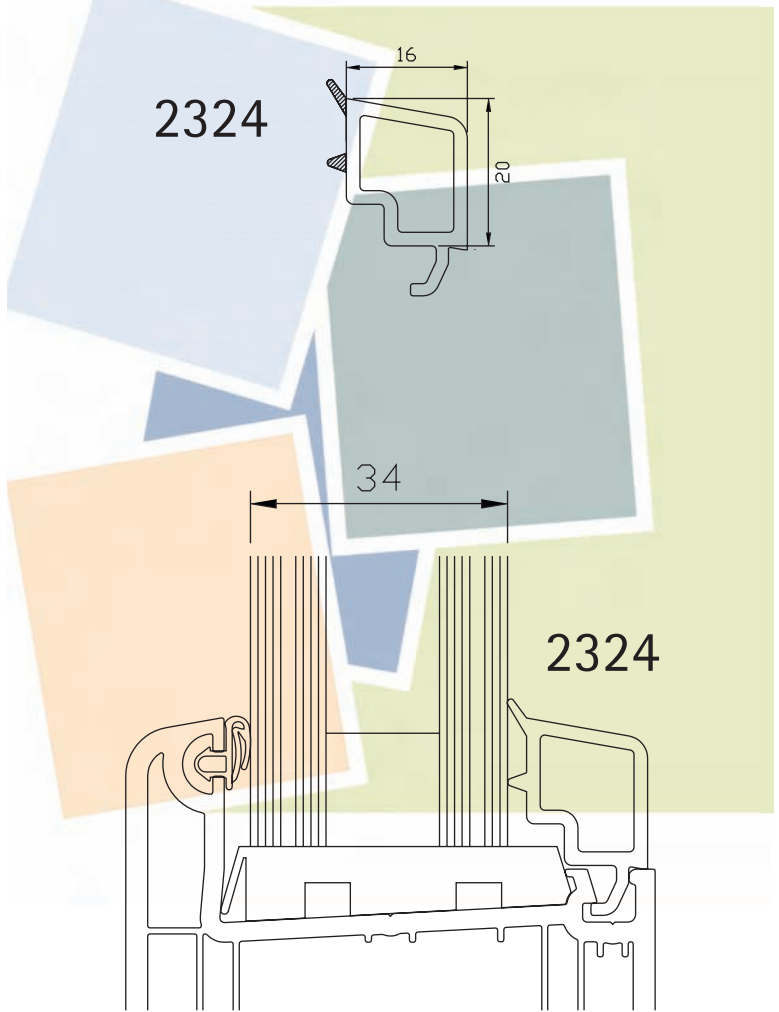
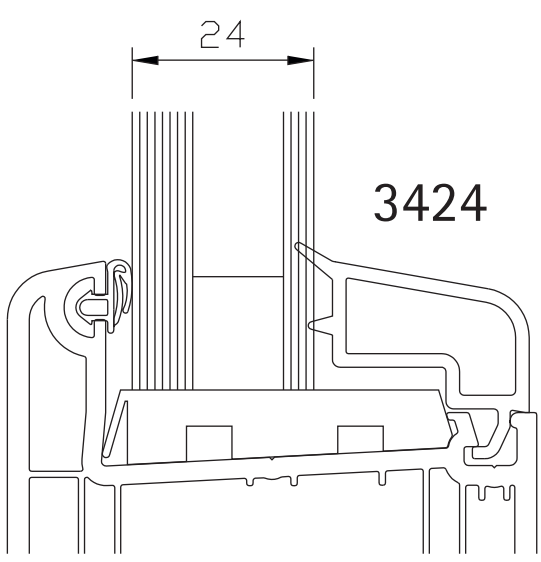
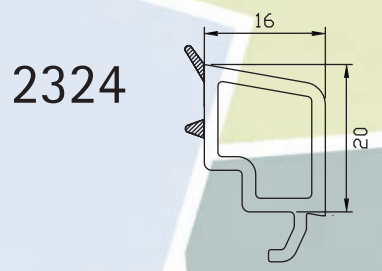
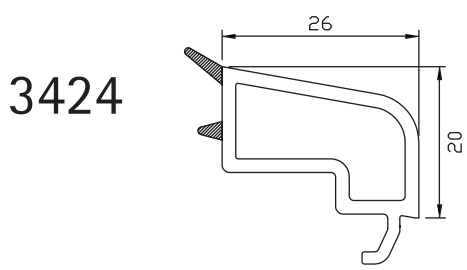

4305	PROLONGADOR 20 mm
4301	PERFIL UNION INERCIA
4302	ESQUINERO 90°

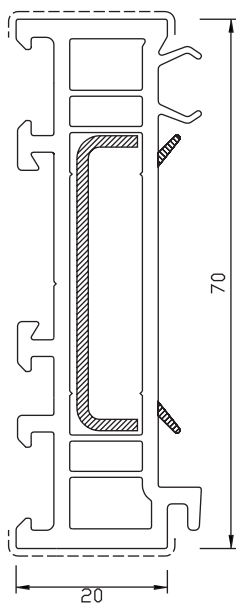
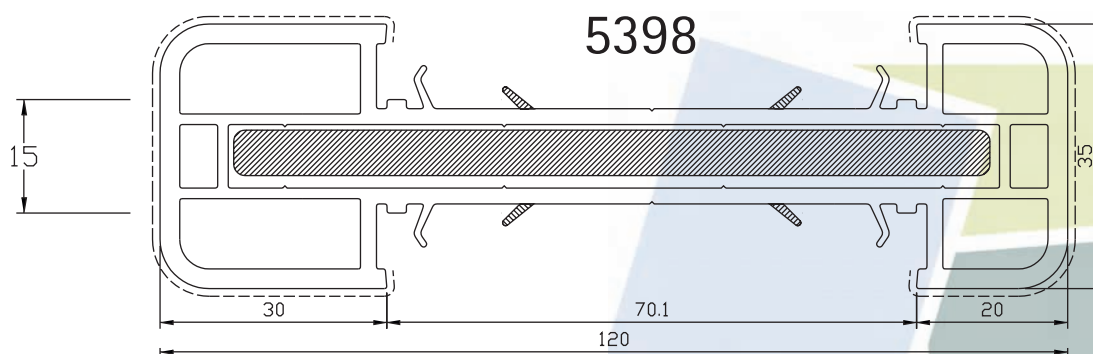

4305

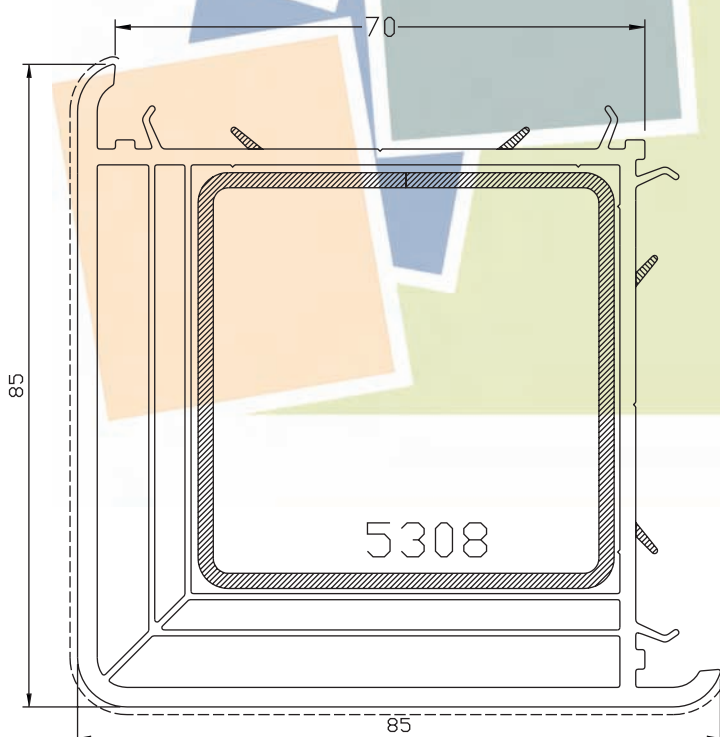

4302

3) SECCION

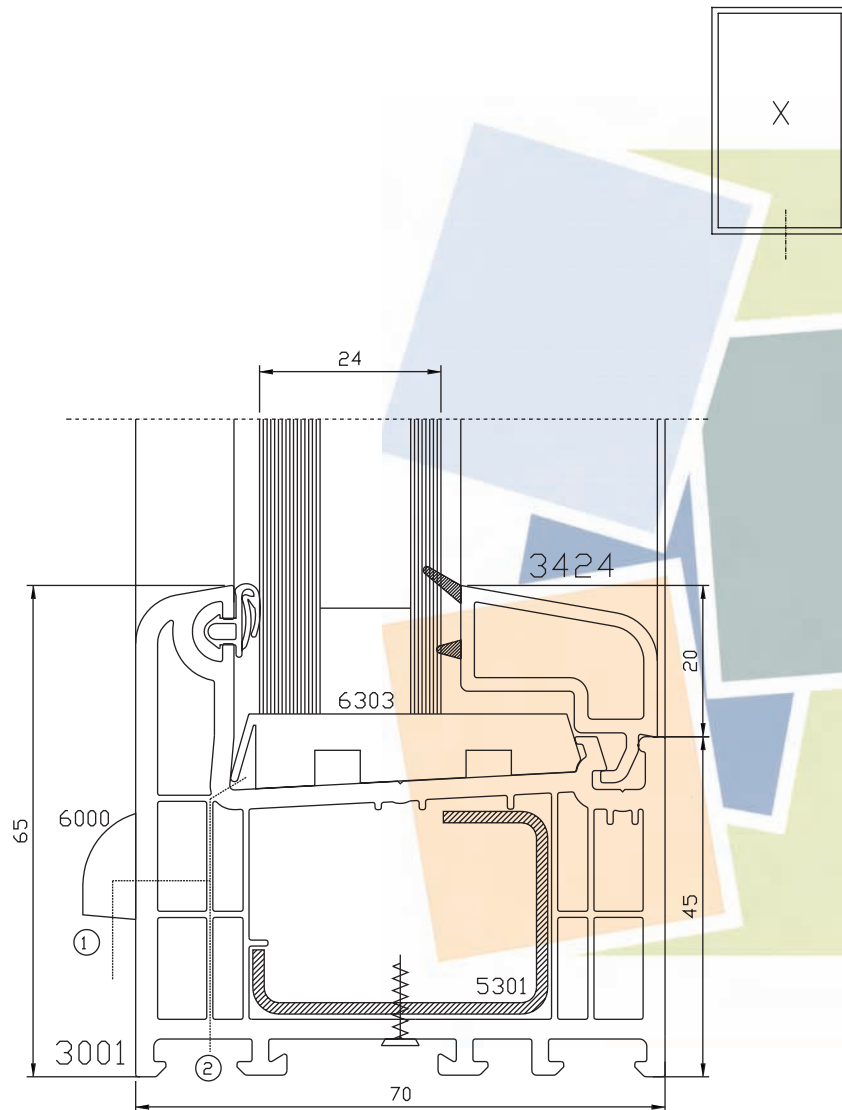

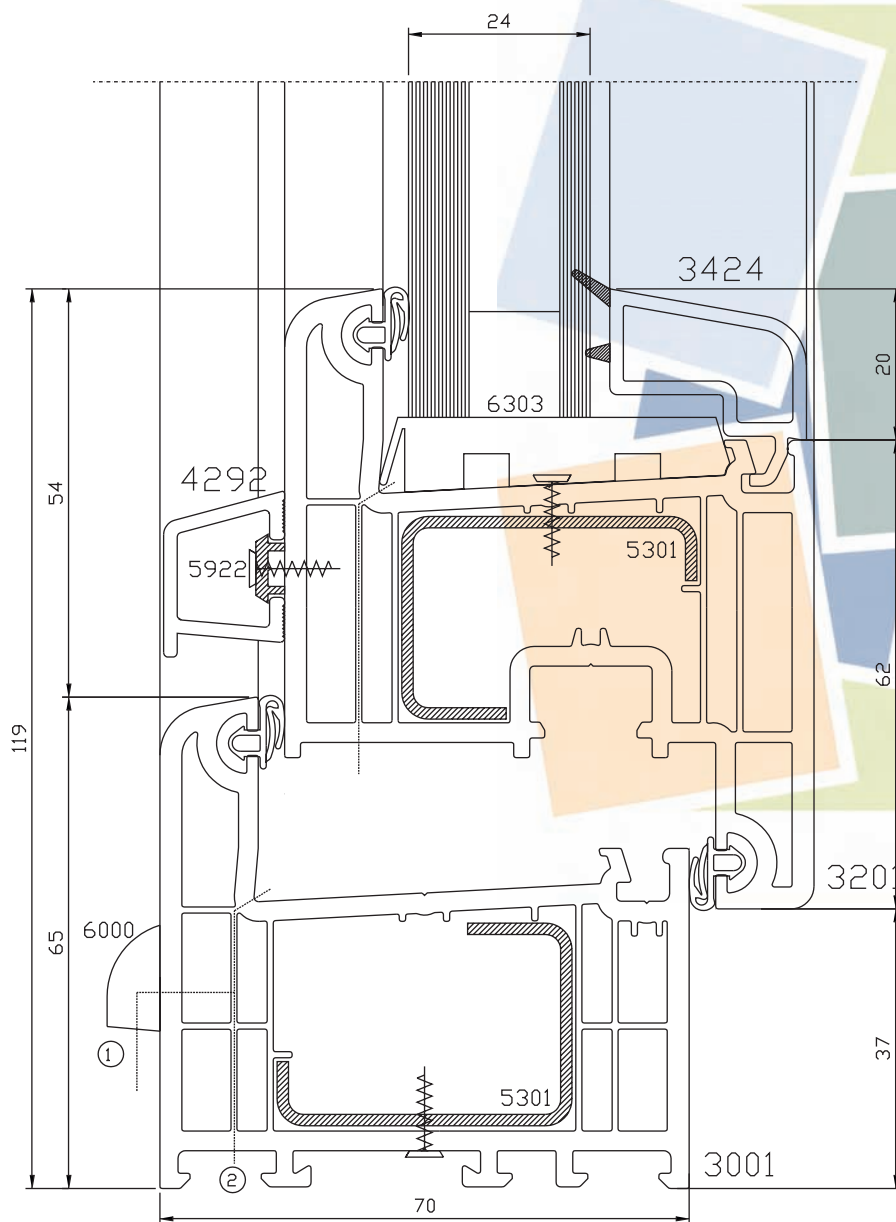
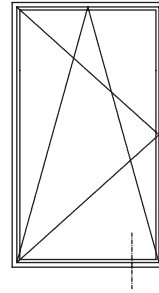

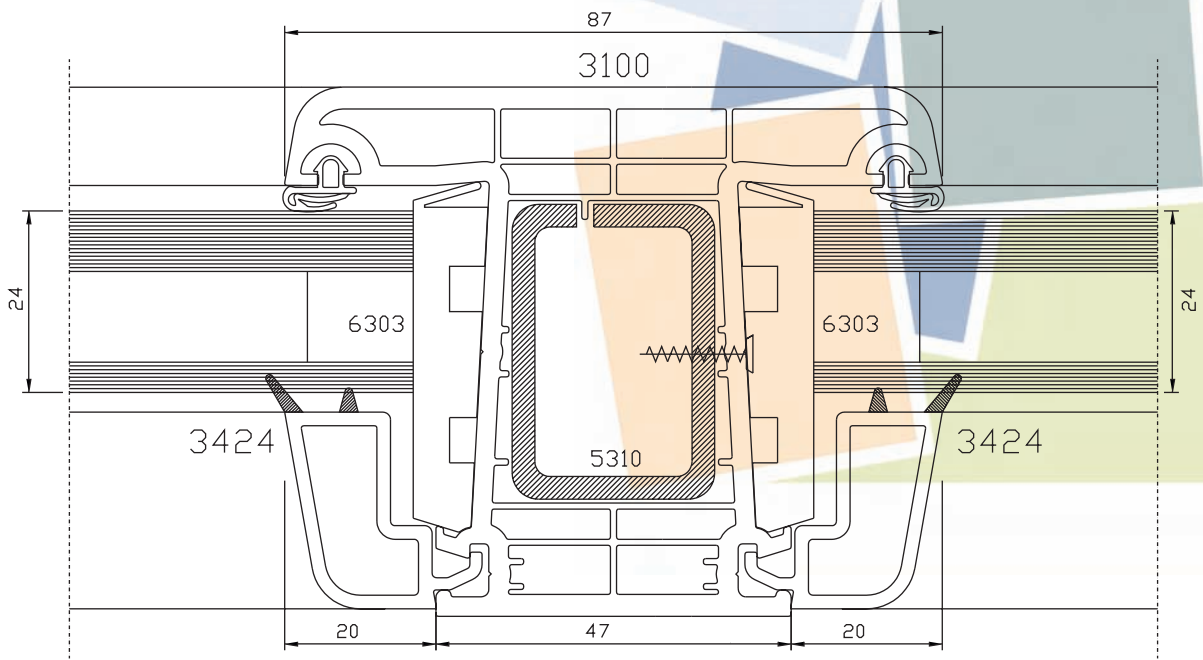
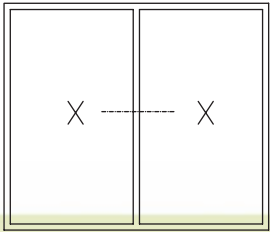

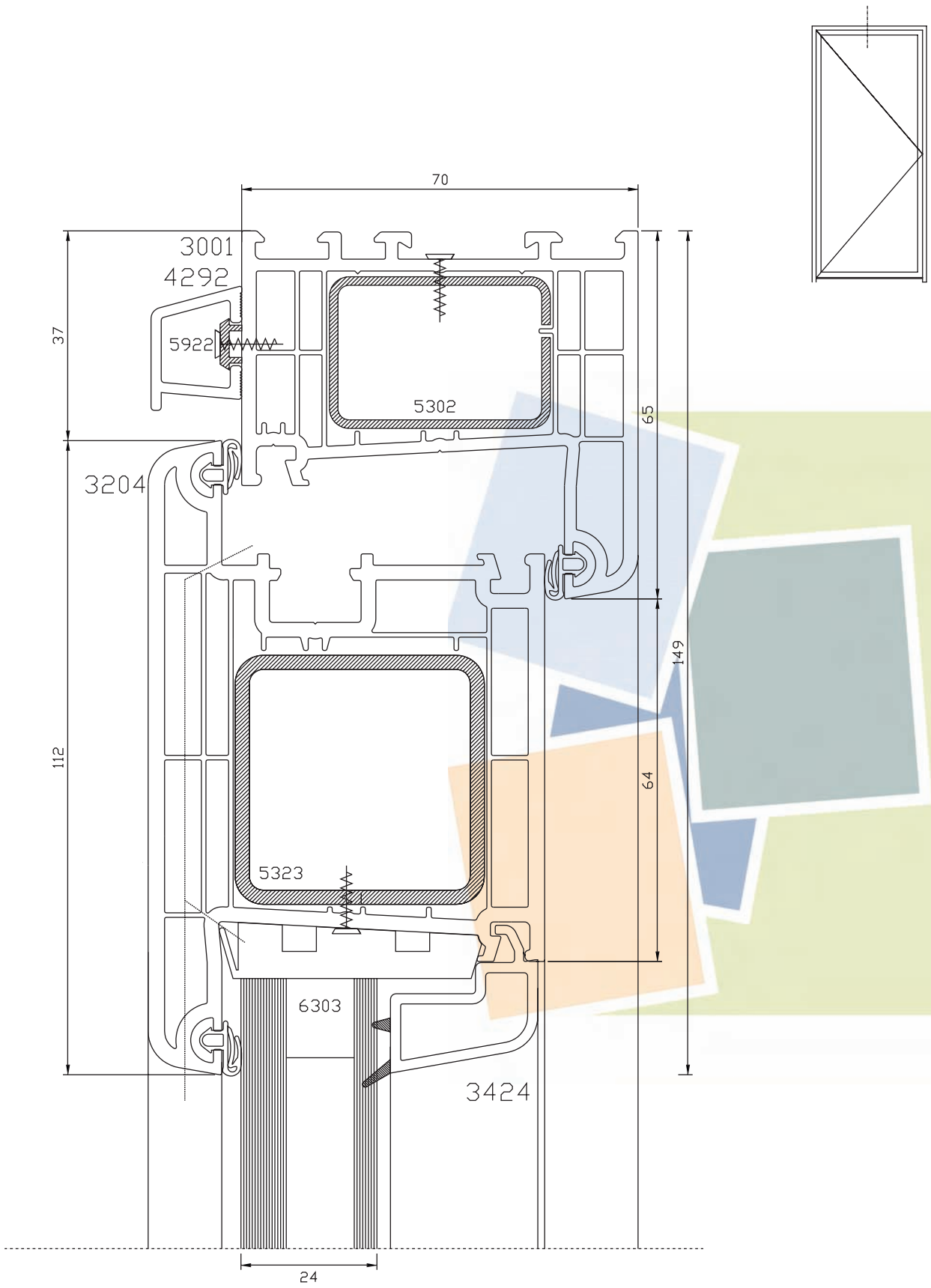

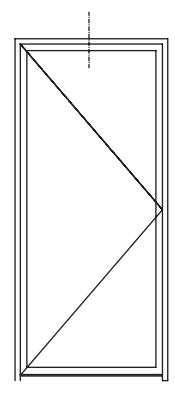
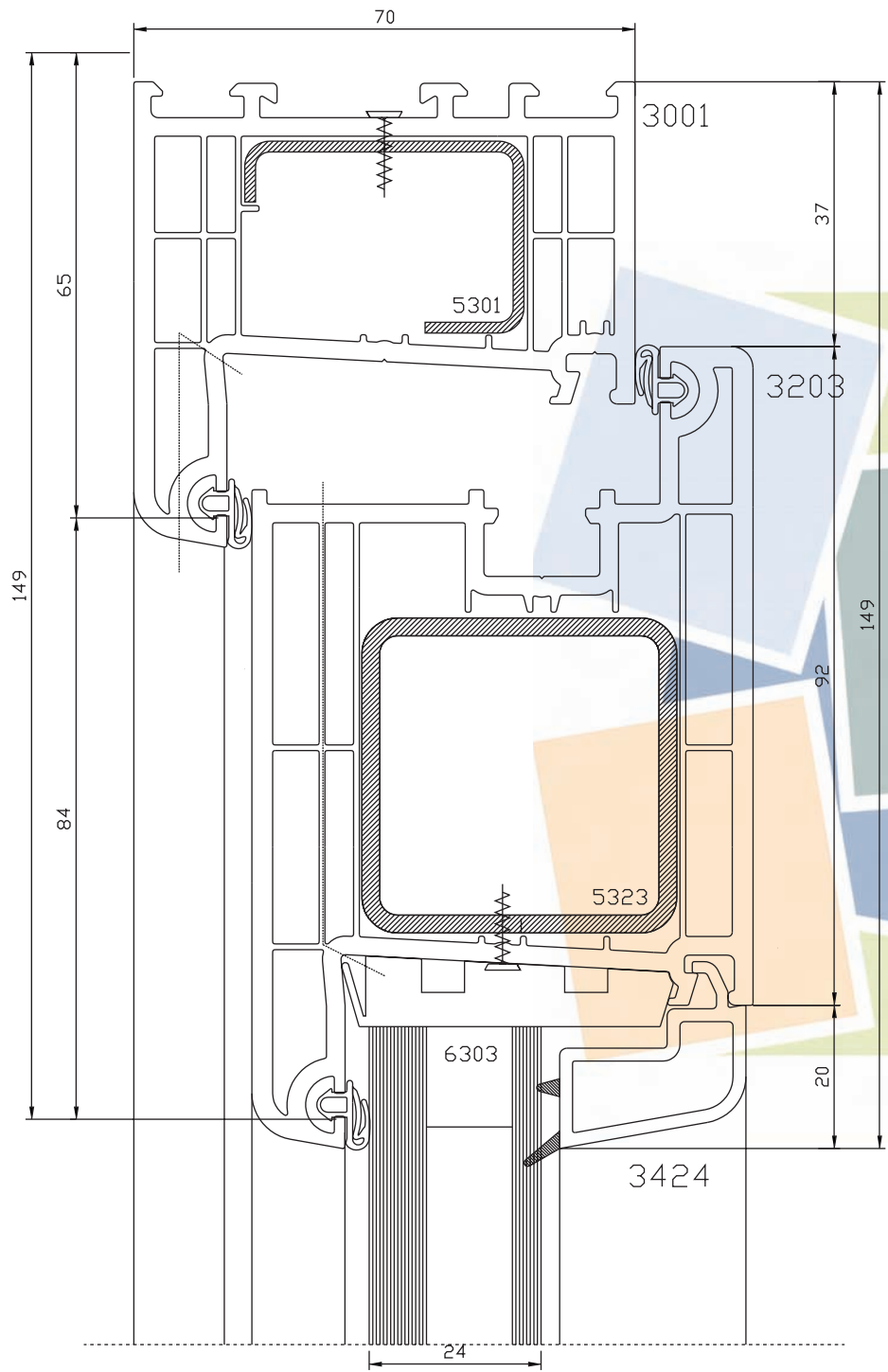

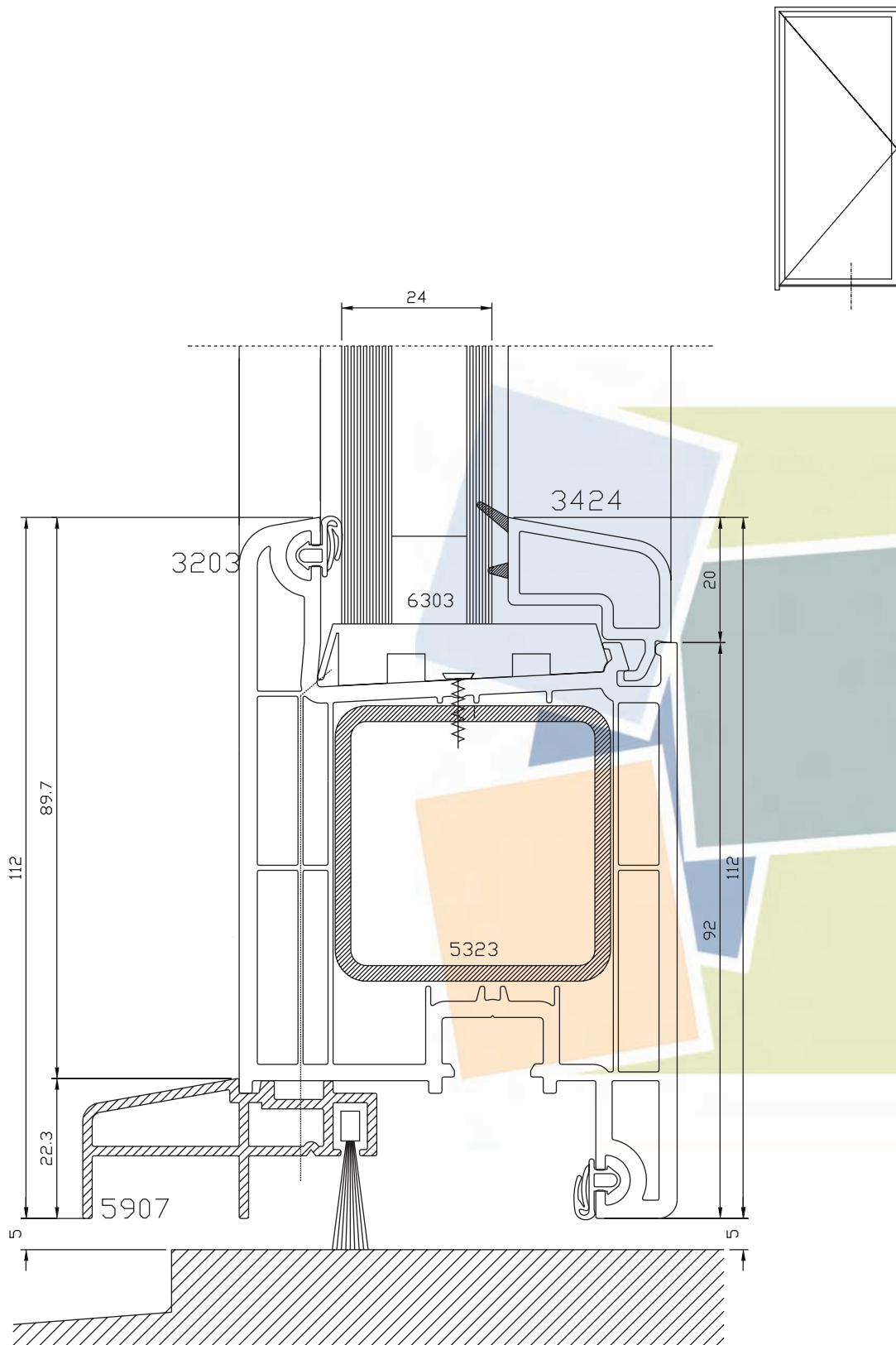

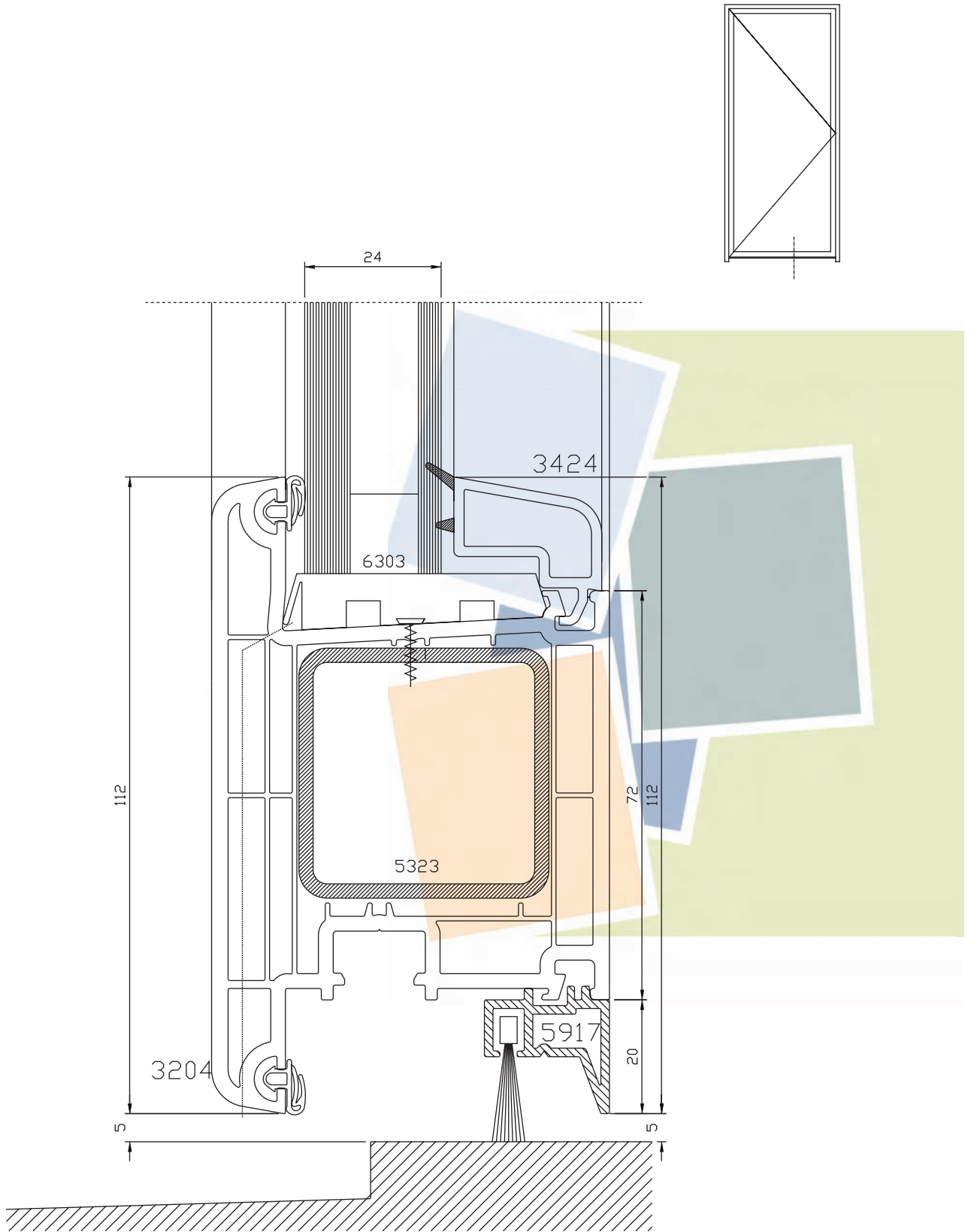

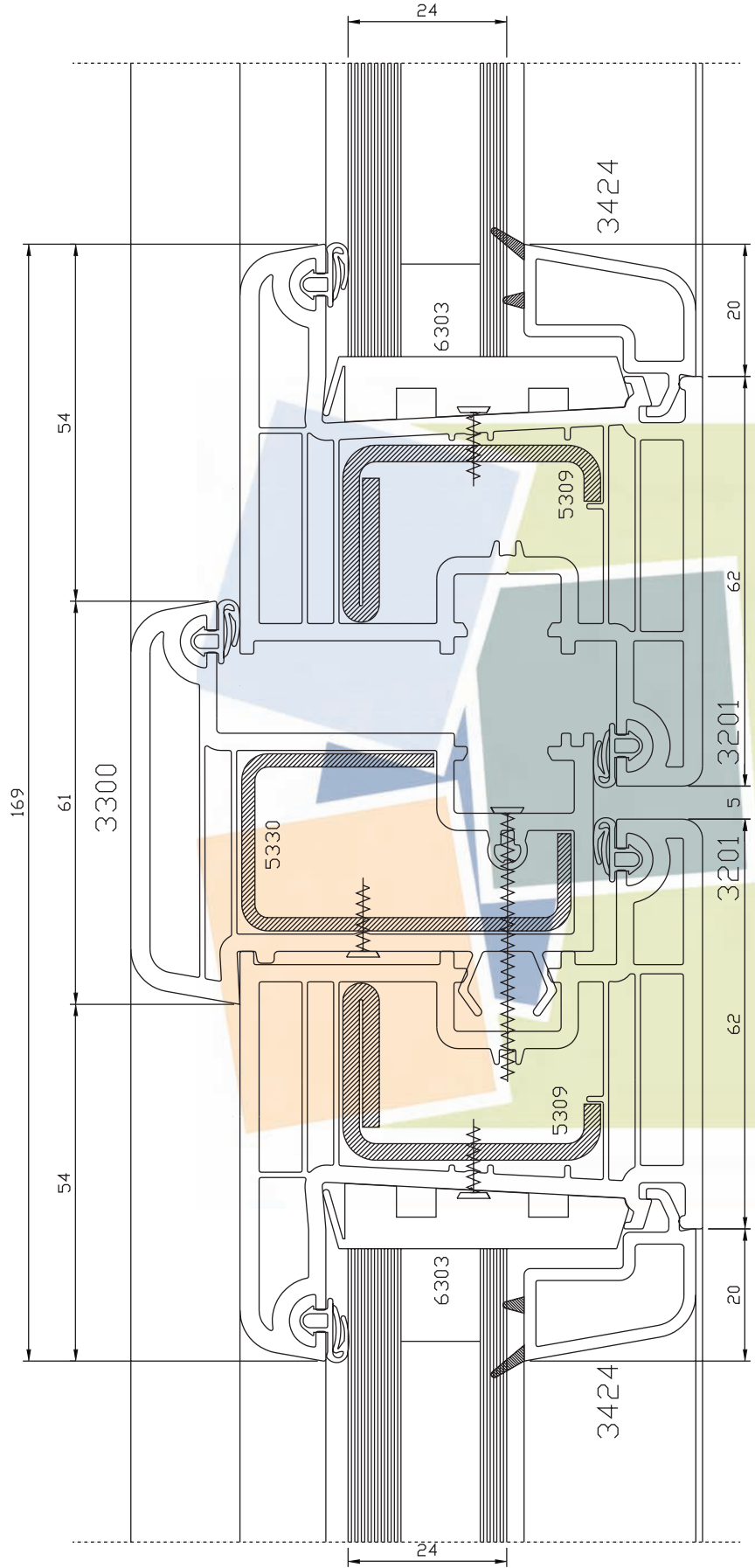
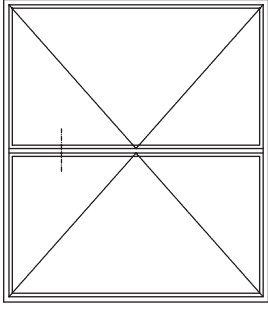

COLORES



Decorbel

Películas

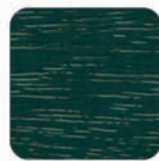

WP006
Verde

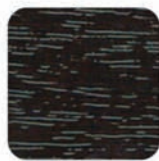

WP008
Castanho Escuro



WP019
Branco



WP020
Pinho Claro



WP021
Carvalho Claro



WP025
Carvalho Escuro



WP026
Mogno



WP110
Pinho Dourado

Lacados



WL006 - Ral:6009
Verde



WL018 - Ral:1013
Beige Claro



WL040 - Ral:5003
Azul Safira



WL070 - Ral:7042
Cinza Claro



WL072 - Ral:7016
Cinza Antracite



WL076 - Ral:3005
Bordeaux



WL077 - Ral:5002
Azul Ultramarino



WL908 - Ral:9006
Alumínio

CAIXIAVE ESPAÑA, SL
Calle Kapelamendi nº 1
Pabellon 39
01013 Vitoria-Gasteiz
(Alava)

Tel +34 945 124 377
Fax +34 945 124 378
E-mail: comercial@caixiave.es

Extremadura

Pol. Ind. "Los Pajares" nave C
10930 Navas del Madroño
(Caceres)

Tel +34 927 375 391
Fax +34 927 375 365

Com. Valenciana y Baleares
Calle Roma nº 6 - 3º bajo
07620 LLucmajor
(Palma de Mallorca)

Tel +34 607 465 039
Fax +34 971 786 052 (Mallorca)
+34 966 422 946 (Valencia)
E-mail: acerisola@ib3.es