



ABITHAL

horizAL

Perfiles

<i>Producto</i>	<i>Pág</i>
Normalizados	2
Chapas	3
Angulos decorados	4
Guias persiana	6
Guia vitrina y división oficina	7
Revestimientos	8
Barandilla mixta	9
Barandilla Horizontal	10
Puertas jardín Horizontal	14
Corredera S-62	15
Corredera S-72	18
Corredera Samblex 65i	21
Corredera Samblex P65CO	26
Corredera P70CO	28
Corredera Abithal Runner	30
Corredera Abithal Runner tt	33
Corredera Euro Runner 250tt	36
Practicable 40 lisa	38
Practicable Samblex 40i	41
Practicable Abithal Euro 40	45
Practicable Abithal Green	49
Practicable Abithal Open Green	55
Practicable Abithal Euro-Keeper 45	56
Practicable Abithal Keeper 61-68	60
Abithal Wood	64
Junquillos cámara europea	68
Euro mallorquina	71
Plegable Garden	76
Abithal Wall	78



Pletinas

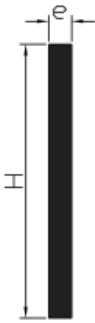

H	e
15	3
20	3
20	10
25	3
30	3
30	5
30	10
40	4
40	10
50	5
60	5
80	10
100	10

Tubos rectangulares

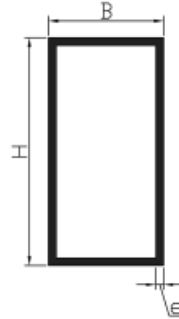

H	B	e
20	10	1,3
30	15	1,3
30	20	1,3
40	20	1,3
40	25	1,5
50	25	1,5
60	20	1,3
60	30	1,3
60	40	1,3
70	20	1,3
80	20	1,3
80	40	1,3
80	60	2
100	40	1,5
100	45	2
120	40	1,7
150	80	2,7

Tubos cuadrados

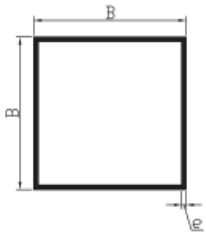

B	e
20	1,3
25	1,3
30	1,3
35	1,3
40	1,3
45	1,5
50	1,5
60	1,5
70	1,5
80	1,8
100	1,8

Angulos lados iguales

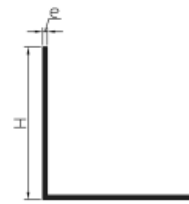

B	e
15	1,3
20	1,3
25	1,3
30	1,3
35	1,3
40	1,3
40	2,7
50	1,5
60	1,5
60	7

Tubos redondos

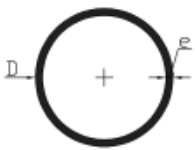

D	e
12,5	3
16	1,5
20	1,5
22	1,5
25	1,5
30	2
40	2
50	2
60	1,8
70	2
80	2,5
100	2,8

Ues

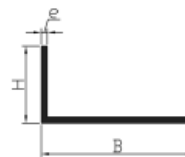

H	B	e
10	10	1,5
15	15	1,3
20	15	1,8
20	20	1,3
25	25	1,3
15	30	1,5
20	40	1,5
40	40	2
25	50	1,5
20	60	1,7
20	100	2

Angulos lados desiguales



B	H	e
20	10	1,3
25	15	1,5
30	20	1,5
35	15	1,3
40	20	1,3
50	25	1,3
60	40	1,5
80	40	1,5

Tes

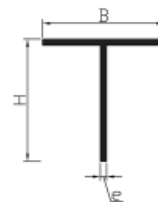

H	B	e
20	20	1,3
25	25	1,3
30	30	2
40	40	1,8

LAS CHAPAS LACADAS Y ANODIZADAS SE SUMINISTRAN CON PROTECCIÓN PLÁSTICA

También se puede suministrar medidas especiales (consultar plazo de entrega)

Chapas

Espesor mm.	Peso teórico por chapa 2000x1000	Peso teórico por chapa 3000x1250
1	5,6 kgs	10,5 kgs
1,5	8,4 kgs	15,8 kgs
2	11,2 kgs	21 kgs
3	16,8 kgs	—

Sandwich

Composición	Dimensiones
0,8+19+0,8	2000x1000

Unipanel

Composición	Dimensiones
0,8+10	3000x1250
0,8+10	3000x310

Sandwich rejilla ventilación

Composición	Dimensiones
0,8+15+0,8	800x200

Chapa Damero



Espesor mm.	Dimensiones
3 + palillo	2000x1000

Chapa Gofrada

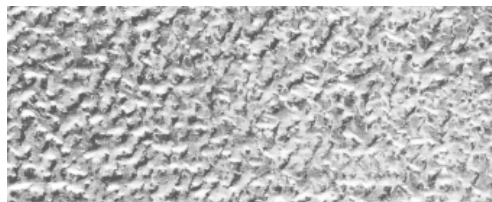

Espesor	Dimensiones
0,6	2000x1000

Chapa para cubiertas

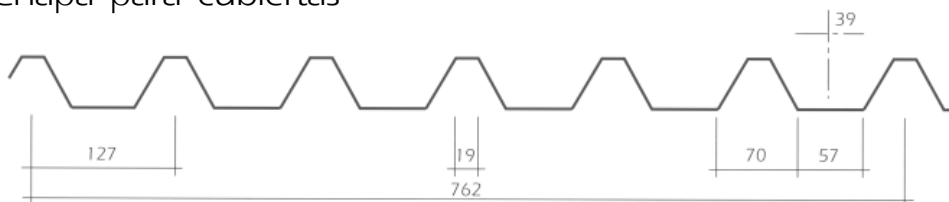

Espesor mm.	Dimensiones
0,6	3000x800

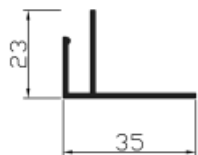

Ref. **6465**
Base chapa registro.

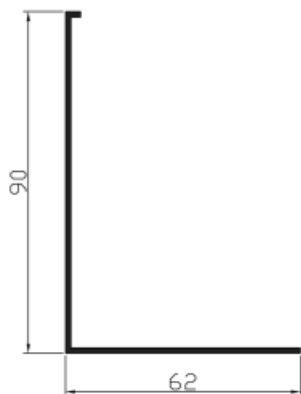

Ref. **9062**
Angulo de 90x62



Ref. **10587**
Perfil para registro

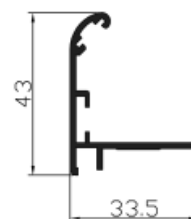

Ref. **21350**
Angulo para registro

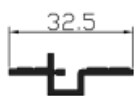

Ref. **21351**
Base registro.

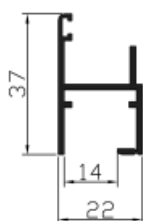

Ref. **24444**
Perfil cajón registro.

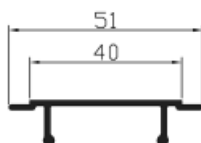

Ref. **62021**
Perfil fijación forro S-62

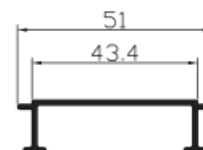

Ref. **62022**
Perfil fijación forro S-62

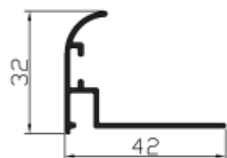

Ref. **65018**
Angulo para registro.

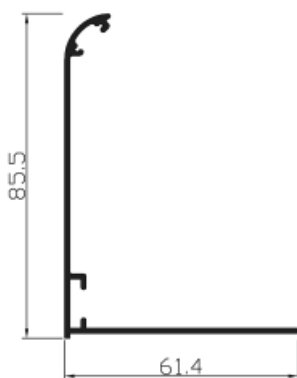

Ref. **65019**
Angulo curvo.

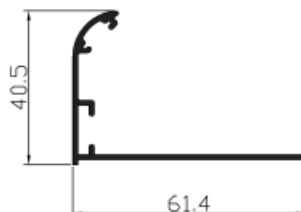

Ref. **65020**
Angulo curvo.

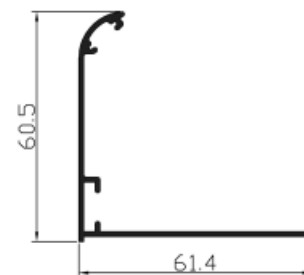

Ref. **65021**
Angulo curvo

Angulos decorados

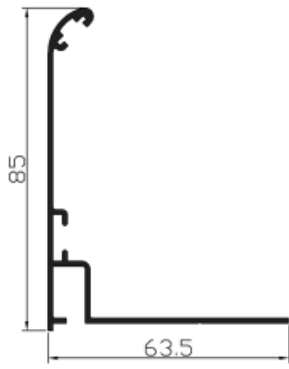

Ref. **65022**
Angulo para registro.

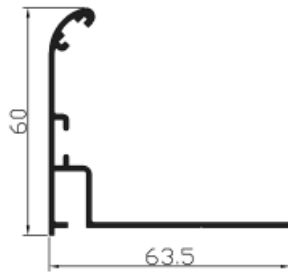

Ref. **65023**
Angulo para registro

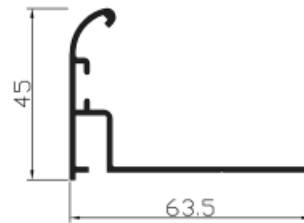

Ref. **65024**
Angulo para registro.

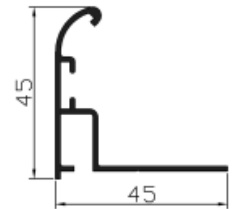

Ref. **65025**
Angulo para registro



Ref. **65026**
Base registro.

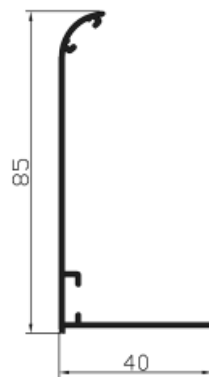

Ref. **65031**
Angulo curvo.

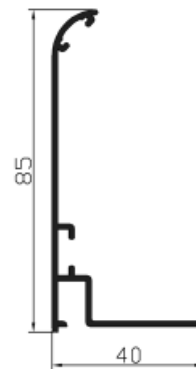

Ref. **65032**
Angulo para registro.

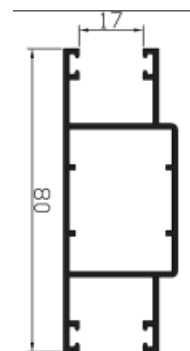
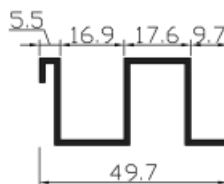
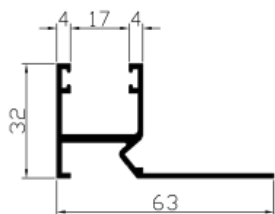
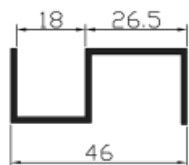

Ref. **752**
Guía persiana 752

Ref. **1059**
Guía de persiana 1059

Ref. **5318**
Guía de persiana 5318
***Consultar stock.**

Ref. **7311**
Guía de persiana doble 7311

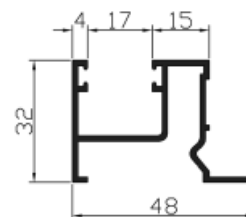
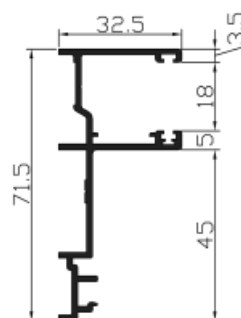
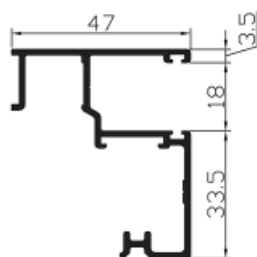
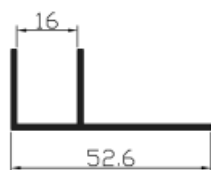

Ref. **10323**
Guía de persiana 10323





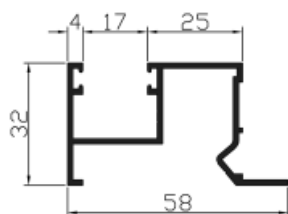

Ref. **24041**
Guía de persiana 24041
***Sobre pedido**

Ref. **24042**
Guía de persiana 24042
***Sobre pedido**

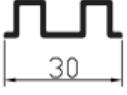
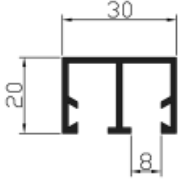
Ref. **24440**
Guía de persiana 24440

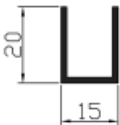

Ref. **24560**
Guía de persiana 24560

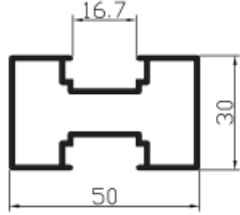
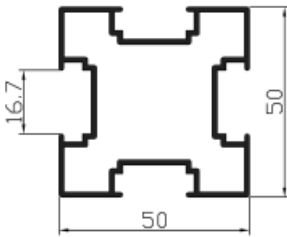
 <p>Ref: Guia Inox 30 Guia Inox de 30 mm.</p>	 <p>Ref: 5030 Guia superior</p>	 <p>Ref: 5031 Hoja casaca</p>	 <p>Ref: 5032 Guia aluminio de 30 mm. Opción en Inox</p>
 <p>Ref: 5033 Perfi U lateral</p>	 <p>Ref: 5035 Perfil U lateral</p>	 <p>Ref: 5045 Hoja casaca</p>	 <p>Ref: 10466 Perfil travesaño</p>
 <p>Ref: 10467 Perfil montante</p>			



Ref. **503-9593**
Lama fija 50x10



Ref. **713**
Perfil de revestimiento



Ref. **1306**
Perfil tubular de revestimiento

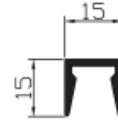

Ref. **1515**
Junquillo 1515

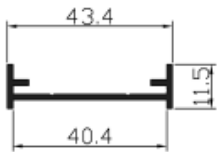

Ref. **2852**
Marco para lama 2853



Ref. **2853**
Lama fija

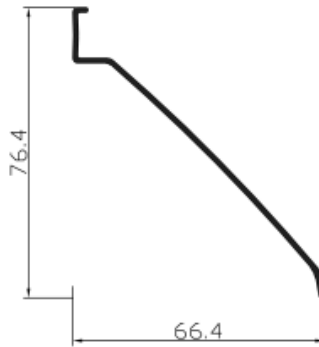

Ref. **R270**
Lama fija

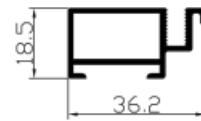

Ref. **7014**
Perfil para premarco

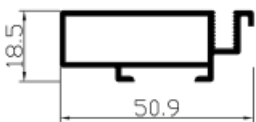

Ref. **7015**
Perfil para premarco

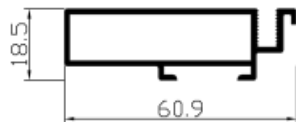



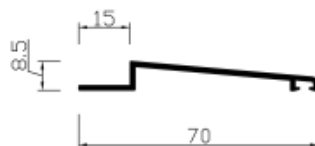



Ref. **7016**
Perfil para premarco

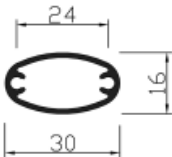
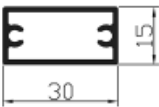
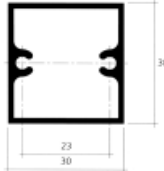
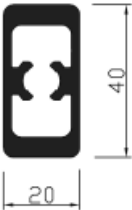
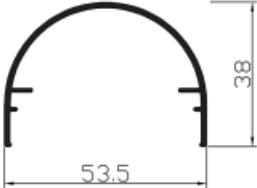
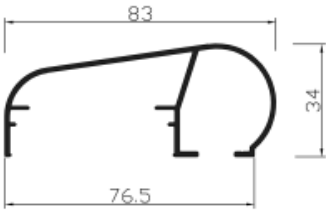

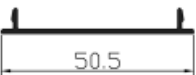
Ref. **PC550**
Perfil goterón

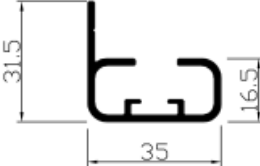
Barandilla mixta

 <p>Ref. 2558 Barrote ovalado</p>	 <p>Ref. 5745 Barrote rectangular</p>	 <p>Ref. 7956 Barrote cuadrado</p>	 <p>Ref. 12727 Perfil rigidizador de barandilla</p>
 <p>Ref. 12801 Pasamano superior curvado</p>	 <p>Ref. 12802 Pasamano con hueco para vidrio</p>	 <p>Ref. 12803 Base pasamano superior</p>	 <p>Ref. 12804 Pasamano inferior</p>
 <p>Ref. 12805 Tapeta pasamano inferior</p>	 <p>Ref. 12806 Perfil para vidrio</p>	 <p>Ref. 12807 Perfil inferior para vidrio</p>	 <p>Ref. 12808 Pasamano plano</p>

DETALLES DE FIJACION A FORJADO

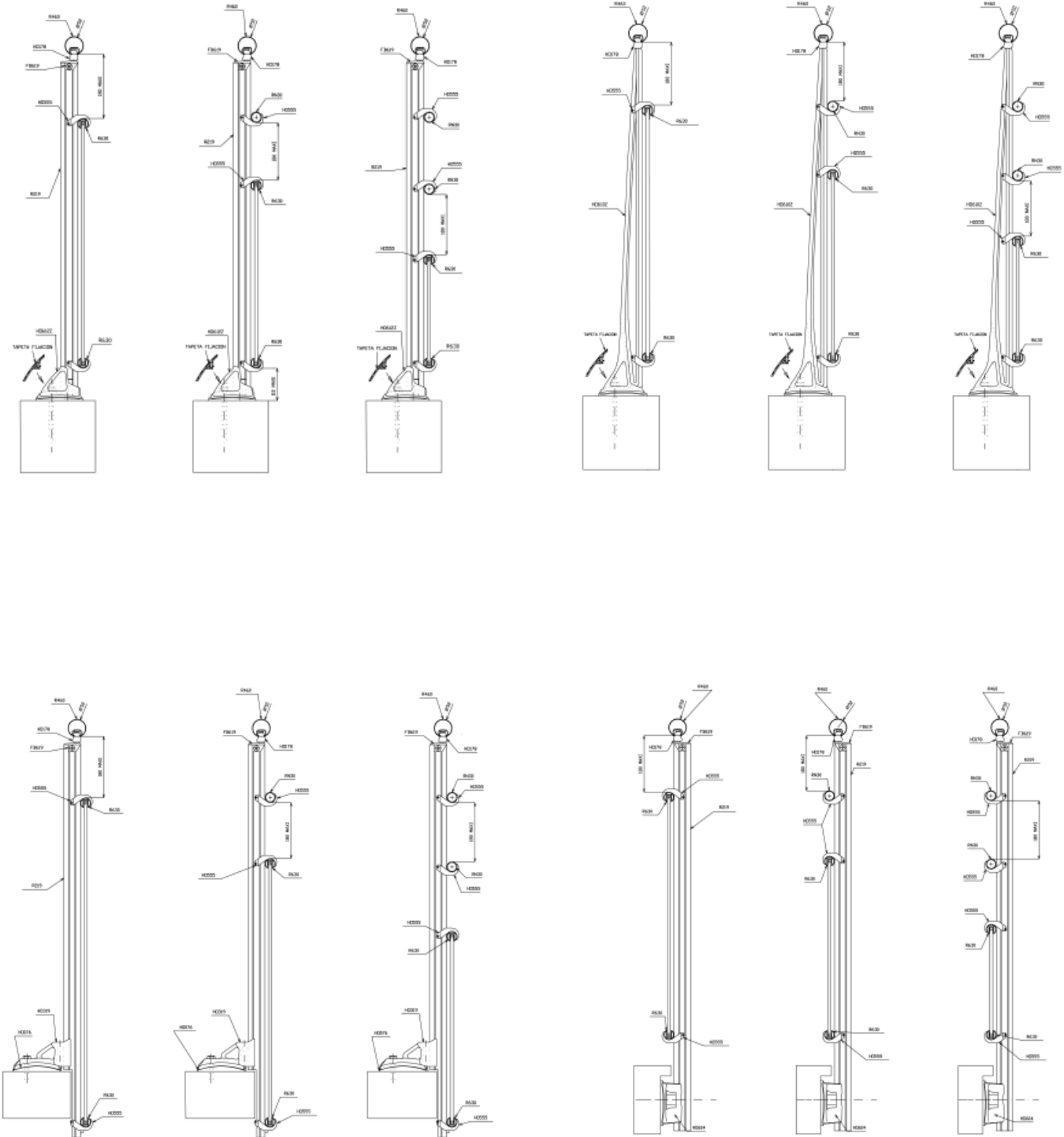

Para más información consultar catálogo específico.

DETALLE DE BARANDILLA ANTARES

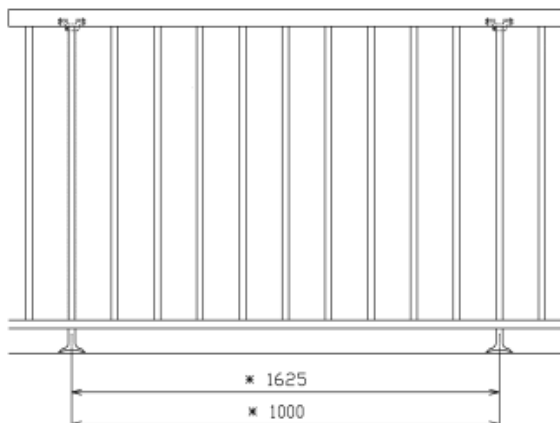

Tramo de barandilla con barrotes fijos montados sin pasamano
Suministro en tramos de 6,5 mts

Ref. **9800910**

Tramo de barandilla de 6,5 mts

* COTAS MÁXIMAS ENTRE PILASTRAS EN EDIFICIOS PRIVADOS / PUBLICOS

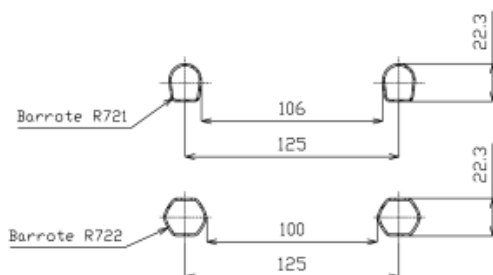

DETALLE DE BARANDILLA RANCH

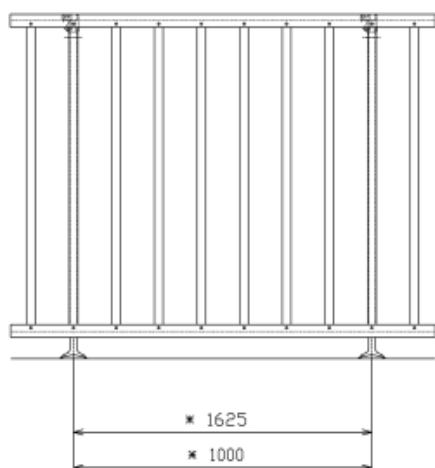

Tramo de barandilla con barrotes montados, preparada para articulación según escalera, incluido pasamano.
Suministro en tramos de 2, 4 y 6 mts.

Ref. **9809382**

Tramo de barandilla de 2 mts

Ref. **9809384**

Tramo de barandilla de 4 mts

Ref. **9809386**

Tramo de barandilla de 6 mts

* COTAS MÁXIMAS ENTRE PILASTRAS EN EDIFICIOS PRIVADOS / PUBLICOS

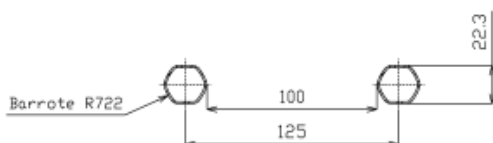

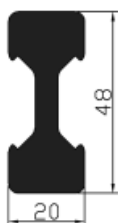

Ref. **R219**
Rigidizador de barandilla HORIZONTAL



Ref. **R460**
Pasamano de barandilla HORIZONTAL R460

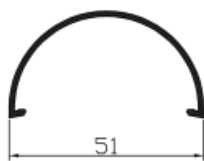

Ref. **R560**
Pasamano de barandilla HORIZONTAL R560

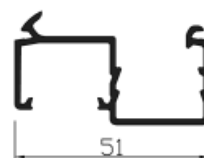

Ref. **R610**
Base de pasamano clipado.

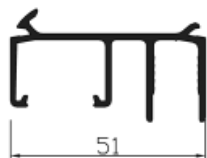

Ref. **R619**
Base de pasamano clipado con entrada de vidrio.

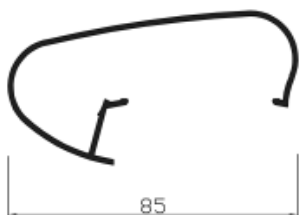

Ref. **R620**
Pasamano de barandilla HORIZONTAL R620



Ref. **R630**
Perfil para vidrio R630



Ref. **R660**
Rigidizador de barandilla HORIZONTAL modelo Ariane (sobre murete).

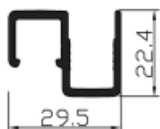

Ref. **R666**
Perfil inferior vidrio



Ref. **R667**
Perfil superior vidrio

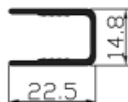



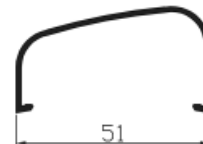



Ref. **R678**
Perfil remate lateral

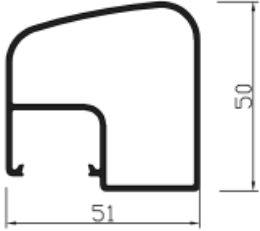
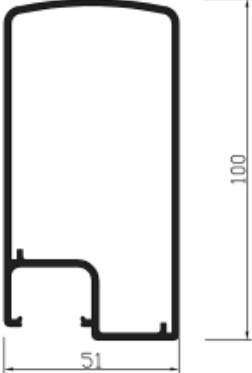
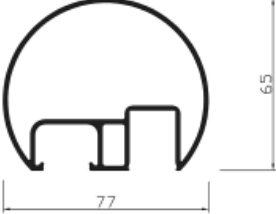

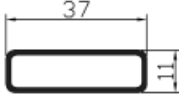
Ref. **R720**
Pasamano de barandilla HORIZONTAL R720

Barandilla Horizontal

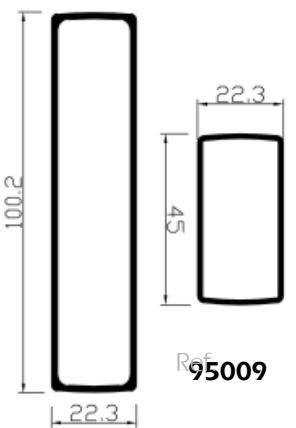
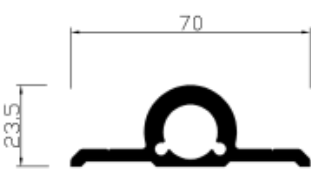
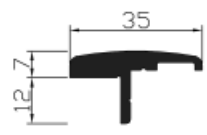
 <p>Ref R740 Pasamano de barandilla HORIZONTAL R740</p>	 <p>Ref R758 Pasamano de barandilla HORIZONTAL R758</p>	 <p>Ref R860 Pasamano de barandilla HORIZONTAL R860 *Consultar</p>	 <p>Ref R861 Tapeta para perfiles R660 y R460</p>
 <p>Ref RD649 Perfil para Cruz de San Andres</p>	 <p>Ref RN30 Tubo redondo RN30</p>		

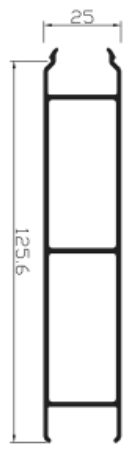
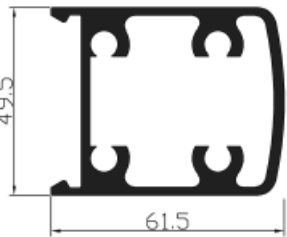
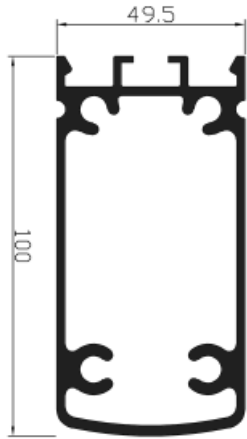
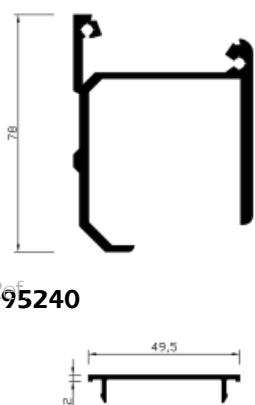
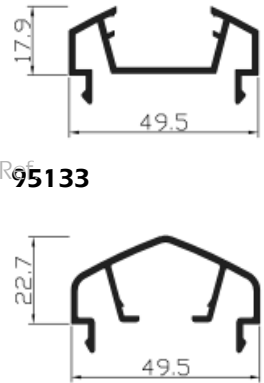
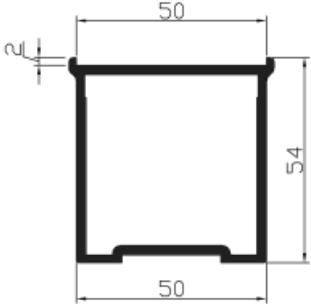
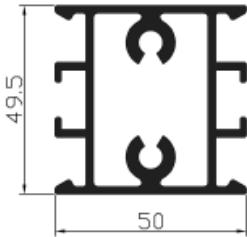
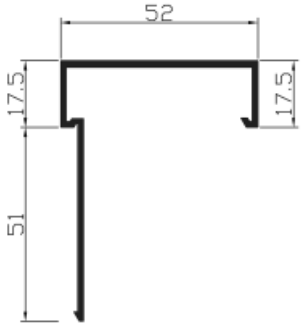
 <p>Ref. 95132 Ref. 95132-95009 Perfil de barrote 100 x 22,3 Perfil de barrote 45 x 22,3</p>	 <p>Ref. 95148 Perfil guia inferior corredera</p>	 <p>Ref. 95194 Perfil tapabocas puerta</p>	 <p>Ref. 95131 Acoplamiento vertical</p>
 <p>Ref. 95130 Lama</p>	 <p>Ref. 95102 Travesaño superior</p>	 <p>Ref. 95000 Travesaño inferior</p>	 <p>Ref. 95240 Ref. RD930 Ref. 95240-RD930 95240 Perfil guia autoportante RD930 Tapeta perfil 95240</p>
 <p>Ref. 95133 Ref. 95002 Ref. 95133-95002 95133 Perfil soporte lamas 95002 Perfil encaste barrotes</p>	 <p>Ref. 95007 Montante vertical</p>	 <p>Ref. 95001 Travesaño intermedio</p>	 <p>Ref. 95101 Montante intermedio vallas</p>



Perfiles extrusionados en aleación 6063 (UNE - 38337)
Estado de suministro T-5
Tolerancias de dimensiones y espesores según norma UNE 38066

Los ensayos son según los especificados por nuestro extrusionador, el ensayo real se deberá realizar por el instalador

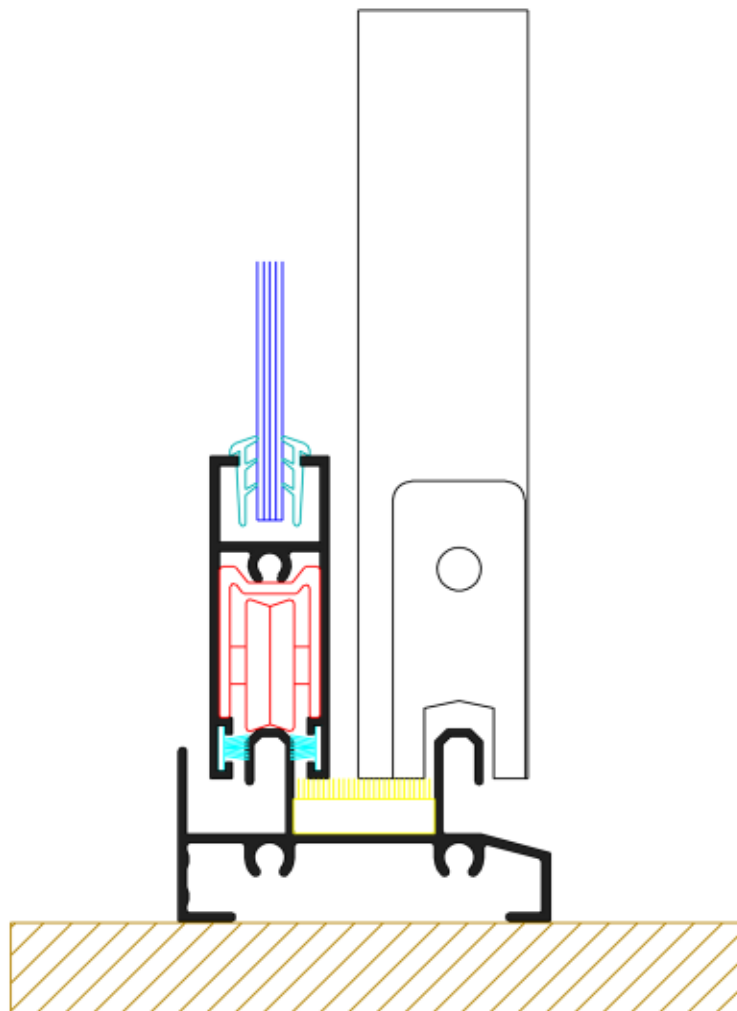
Permeabilidad al agua	Clase A-2
Estanqueidad al agua	Clase E-2
Resistencia al viento	Clase V-2

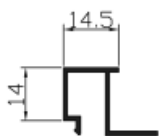
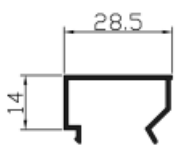
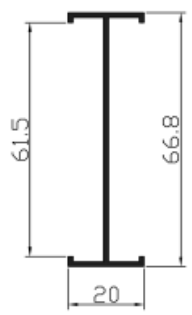
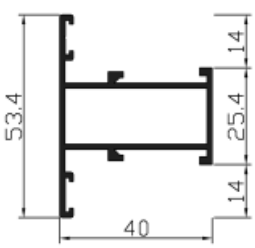
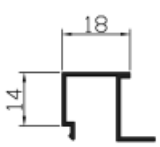
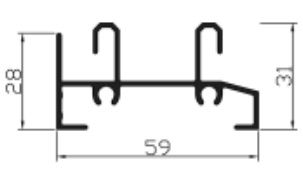
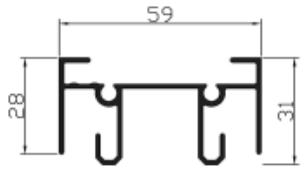
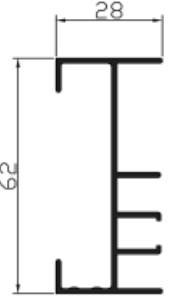
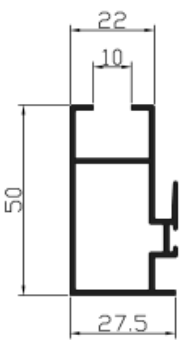
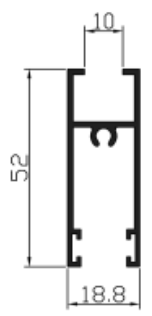
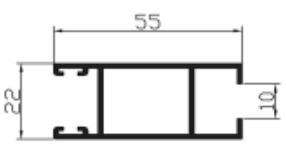
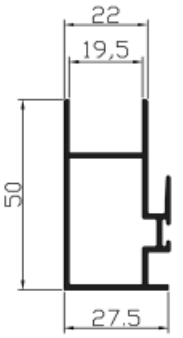

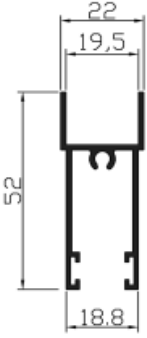
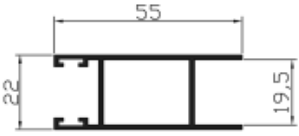
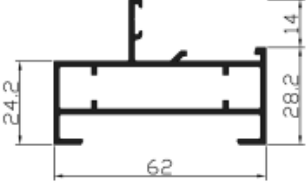
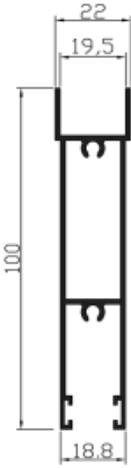
 <p>Ref: 3911 Junquillo de 14,5 mm para fijos * Consultar stock</p>	 <p>Ref: 4343 Junquillo de 28,5 mm para fijos * Consultar stock</p>	 <p>Ref: i0321 Perfil para unión de correderas</p>	 <p>Ref: i0409 Travesaño para partición de fijos</p>
 <p>Ref: i1537 Junquillo de 18 mm para fijos * Consultar stock</p>	 <p>Ref: 62002 Marco inferior corredera</p>	 <p>Ref: 62003 Marco superior corredera</p>	 <p>Ref: 62004 Marco lateral corredera</p>
 <p>Ref: 62012 Perfil de cruce para vidrio normal</p>	 <p>Ref: 62013 Hoja casaca para vidrio normal</p>	 <p>Ref: 62014 Hoja lateral para vidrio normal</p>	 <p>Ref: 62015 Perfil de cruce para vidrio cámara</p>

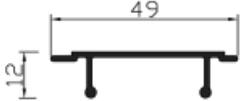
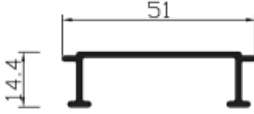

 <p>Ref. 62016 Hoja casaca para vidrio cámara</p>	 <p>Ref. 62017 Hoja lateral para vidrio cámara</p>	 <p>Ref. 62018 Perfil para fijos</p>	 <p>Ref. 62019 Hoja zócalo para vidrio cámara</p>
 <p>Ref. 62020 Hoja zócalo para vidrio normal</p>	 <p>Ref. 62021 Perfil para fijar ángulos a marcos</p>	 <p>Ref. 62022 Hoja para fijar ángulos a marcos</p>	

Perfiles extrusionados en aleación 6063 (UNE - 38337)
Estado de suministro T-5
Tolerancias de dimensiones y espesores según norma UNE 38066

Los ensayos son según los especificados por nuestro extrusionador, el ensayo real se deberá realizar por el instalador

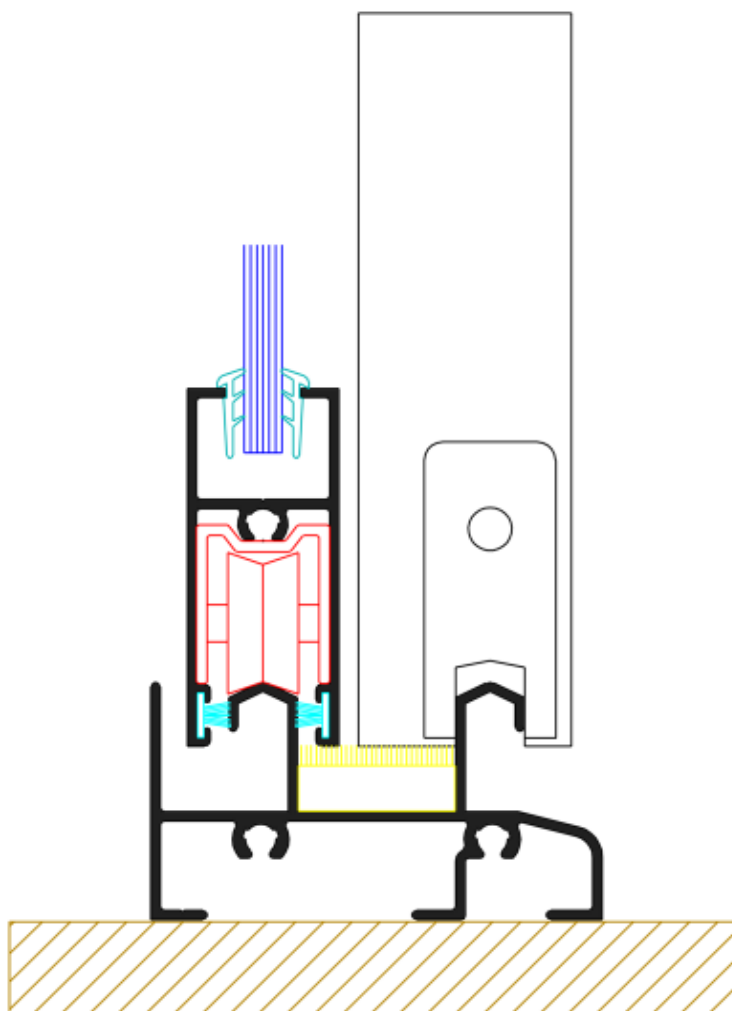
Permeabilidad al agua	Clase A-2
Estanqueidad al agua	Clase E-2
Resistencia al viento	Clase V-2

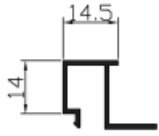
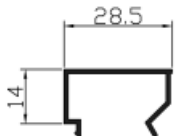
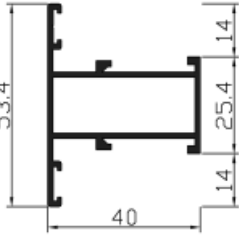
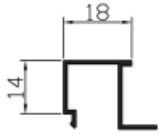
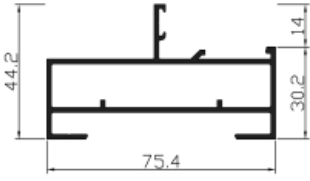
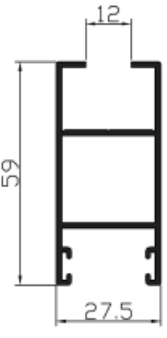
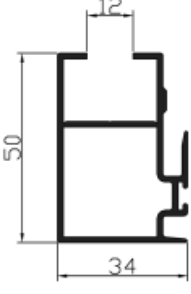
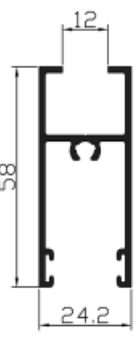
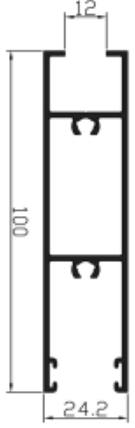
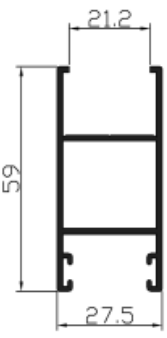
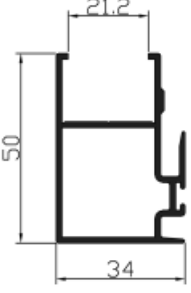

 <p>Ref 3911 Junquillo de 14,5 mm para fijos * Consultar stock</p>	 <p>Ref 4343 Junquillo de 28,5 mm para fijos * Consultar stock</p>	 <p>Ref i0409 Travesaño para partición de fijos</p>	 <p>Ref i1537 Junquillo de 18 mm para fijos * Consultar stock</p>
 <p>Ref 72014 perfil de marco para fijos</p>	 <p>Ref 72015 Hoja lateral para vidrio normal</p>	 <p>Ref 72016 Hoja cruce para vidrio normal</p>	 <p>Ref 72017 Hoja casaca para vidrio normal</p>
 <p>Ref 72018 Hoja zócalo para vidrio normal</p>	 <p>Ref 72019 Hoja lateral para vidrio cámara</p>	 <p>Ref 72020 Hoja cruce para vidrio cámara</p>	 <p>Ref 72021 Hoja casaca para vidrio cámara</p>

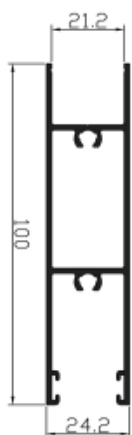

Ref. **72022**
Hoja zócalo para vidrio cámara

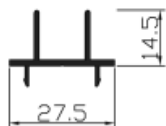

Ref. **72023**
Perfil acoplamiento cuatro hojas

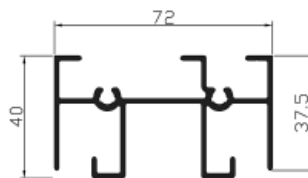

Ref. **72095**
Marco superior

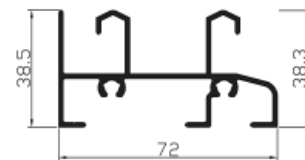

Ref. **72096**
Hoja inferior

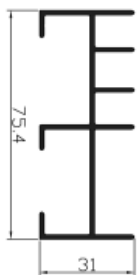

Ref. **72097**
Marco lateral

Perfiles extrusionados en aleación 6063 (UNE - 38337)
Estado de suministro T-5
Tolerancias de dimensiones y espesores según norma UNE 38066

Los ensayos han sido realizados en Ornago (Milán), en una ventana de dos hojas de medidas 1600 x 1360 mm., con los siguientes resultados:

Permeabilidad al agua	Clase A-3
Estanqueidad al agua	Clase E-2
Resistencia al viento	Clase V-1

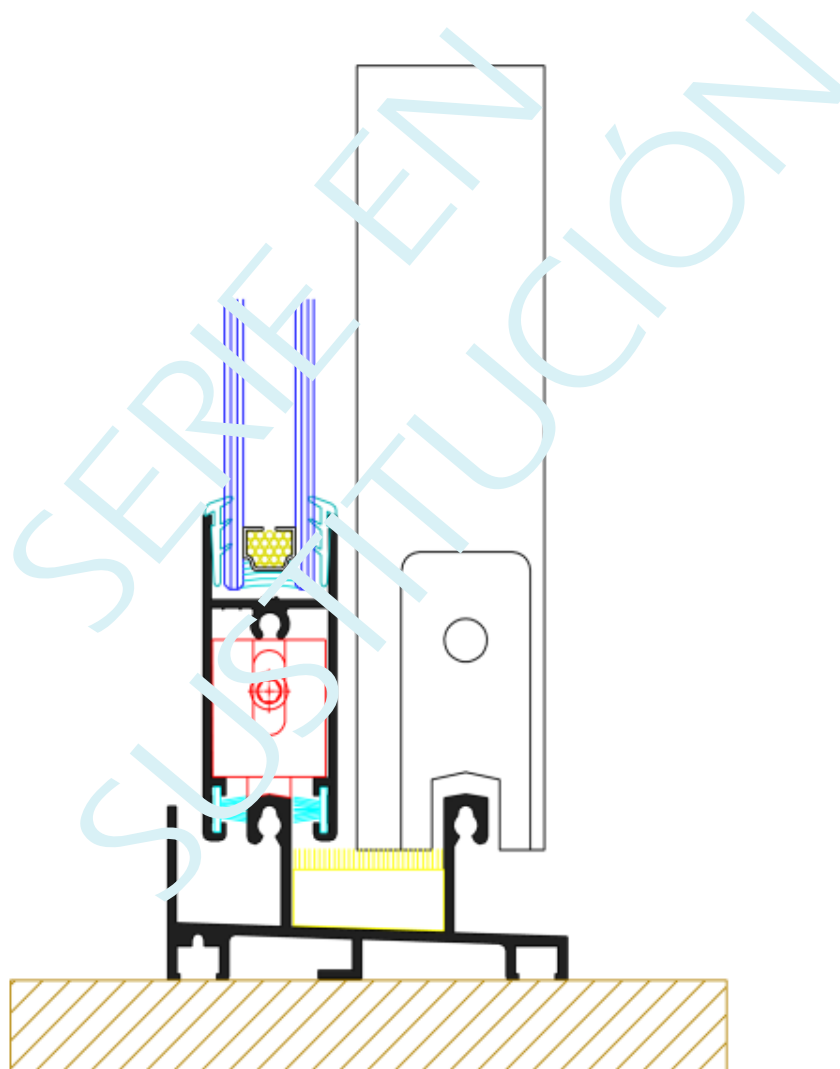

Series en
sustitución

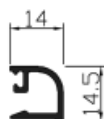

Ref. **i9720**
Junquillo de punto redondo de 14 mm con grapa

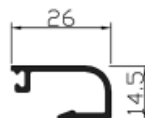

Ref. **i9721**
Junquillo de punto redondo de 26 mm con grapa

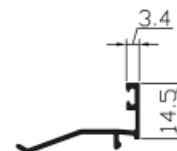

Ref. **i9727**
Junquillo recto de 3,4 mm

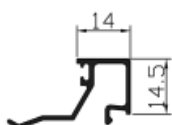

Ref. **i9728**
Junquillo recto de 14 mm

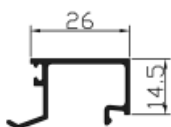

Ref. **i9729**
Junquillo recto de 26 mm

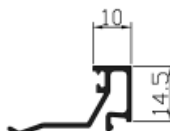

Ref. **26185**
Junquillo recto de 10 mm

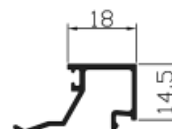

Ref. **21687**
Junquillo recto de 18 mm.

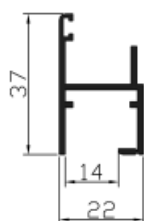

Ref. **24444**
Perfil cajón registro



Ref. **24553**
Angulo para registro 51,6 mm.

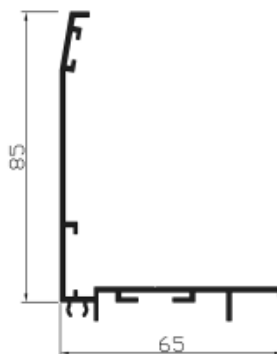

Ref. **24554**
Angulo para registro 85 mm

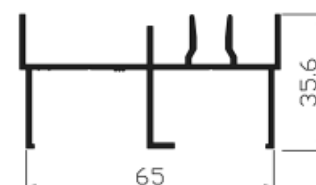

Ref. **24555**
Marco lateral reforzado

Corredera Samblex 65i

<p>Ref. 24564 Marco inferior tubular</p>	<p>Ref. 24571 Marco lateral</p>	<p>Ref. 24572 Esquinero 90°</p>	<p>Ref. 24573 Angulo tapajuntas clipado de 85</p>
<p>Ref. 24574 Angulo tapajuntas clipado de 35 * Consultar stock</p>	<p>Ref. 24579 Perfil acoplamiento 4 hojas</p>	<p>Ref. 24580 Perfil unión correderas</p>	<p>Ref. 24581 Perfil unión corredera y practicable</p>
<p>Ref. 24582 Perfil tapajuntas</p>	<p>Ref. 24586 Hoja zócalo para vidrio cámara</p>	<p>Ref. 24587 Hoja zócalo para vidrio normal</p>	<p>Ref. 24588 Hoja cruce para vidrio cámara</p>

Series en sustitución

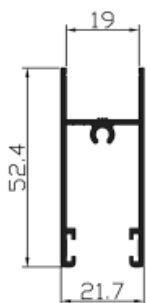

Ref. **24589**
Hoja casaca para vidrio cámara

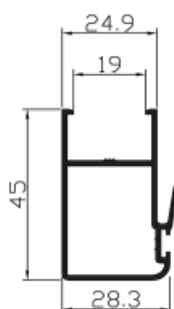

Ref. **24590**
Hoja cruce para vidrio cámara

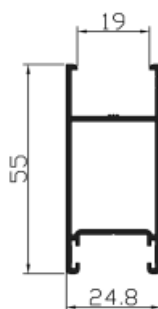

Ref. **24591**
Hoja lateral para vidrio cámara

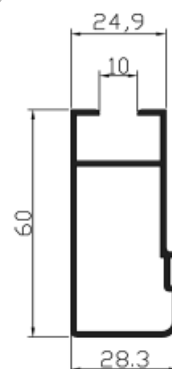

Ref. **24592**
Hoja cruce para vidrio normal

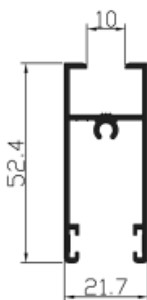

Ref. **24593**
Hoja casaca para vidrio normal

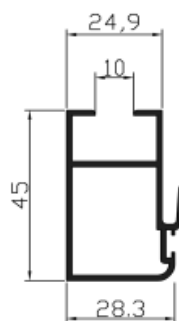

Ref. **24594**
Hoja cruce para vidrio normal

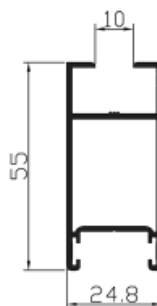

Ref. **24595**
Hoja lateral para vidrio normal

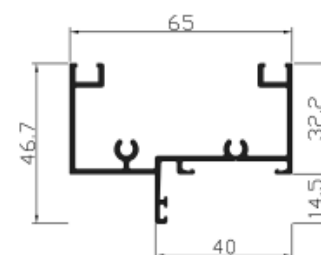

Ref. **24596**
Perfil marco fijo

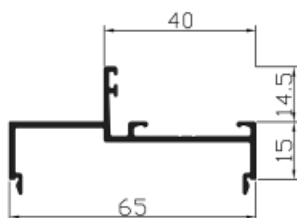

Ref. **24597**
Perfil marco fijo clipado

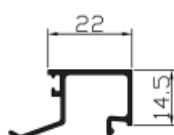

Ref. **26184**
Junquillo recto de 22 mm

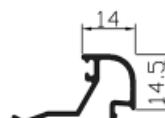

Ref. **26197**
Junquillo de punto redondo de 14 mm clipado

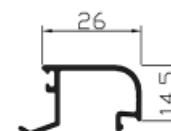

Ref. **26198**
Junquillo de punto redondo de 26 mm clipado

Corredera Samblex 65i

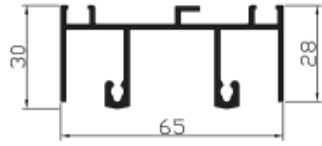

Ref. **27595**
Marco superior

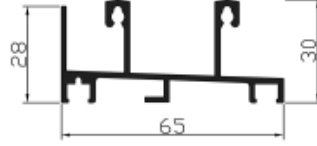

Ref. **27596**
Marco inferior

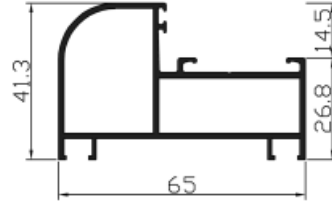

Ref. **65009**
Marco para fijos

Perfiles extrusionados en aleación 6063 (UNE - 38337)
Estado de suministro T-5
Tolerancias de dimensiones y espesores según norma UNE 38066

Los ensayos han sido realizados en Cidemco (Guipúzcoa), en una ventana de dos hojas de medidas 1550 x 1350 mm., con los siguientes resultados:

Permeabilidad al agua	Clase A-2 mejorada
Estanqueidad al agua	Clase E-2 mejorada
Resistencia al viento	Clase V-2 mejorada

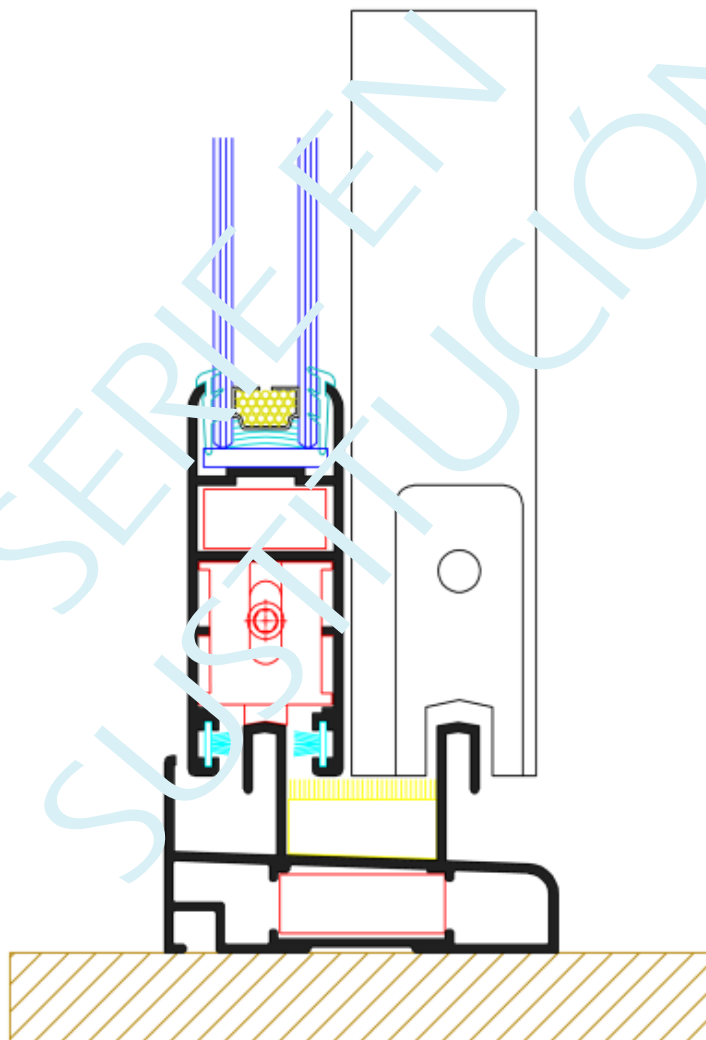

Corredera Samblex P65CO

<p>Ref. 65001 Hoja perimetral vidrio normal</p>	<p>Ref. 65002 Hoja perimetral vidrio cámara</p>	<p>Ref. 65003 Perfil cruce para hojas 65001-65002</p>	<p>Ref. 65004 Hoja perimetral vidrio normal</p>
<p>Ref. 65005 Hoja perimetral vidrio cámara</p>	<p>Ref. 65006 Perfil cruce para hojas 65004-65005</p>	<p>Ref. 65007 Perfil acoplamiento 4 hojas</p>	<p>Ref. 65027 Marco perimetral 65 mm</p>
<p>Ref. 65028 Marco perimetral 58 mm</p>	<p>Ref. 65029 Perfil para fijos, compatibles con Euro40 y junquillos cámara europ.</p>	<p>Ref. 65030 Perfil para fijos, compatibles con Euro40 y junquillos cámara europ.</p>	

Perfiles extrusionados en aleación 6063 (UNE - 38337)
Estado de suministro T-5
Tolerancias de dimensiones y espesores según norma UNE 38066

Los ensayos han sido realizados en Cidemco (Guipúzcoa), en una ventana de dos hojas de medidas 1550 x 1350 mm., con los siguientes resultados:

Permeabilidad al agua	Pendiente clasificación
Estanqueidad al agua	Pendiente clasificación
Resistencia al viento	Pendiente clasificación

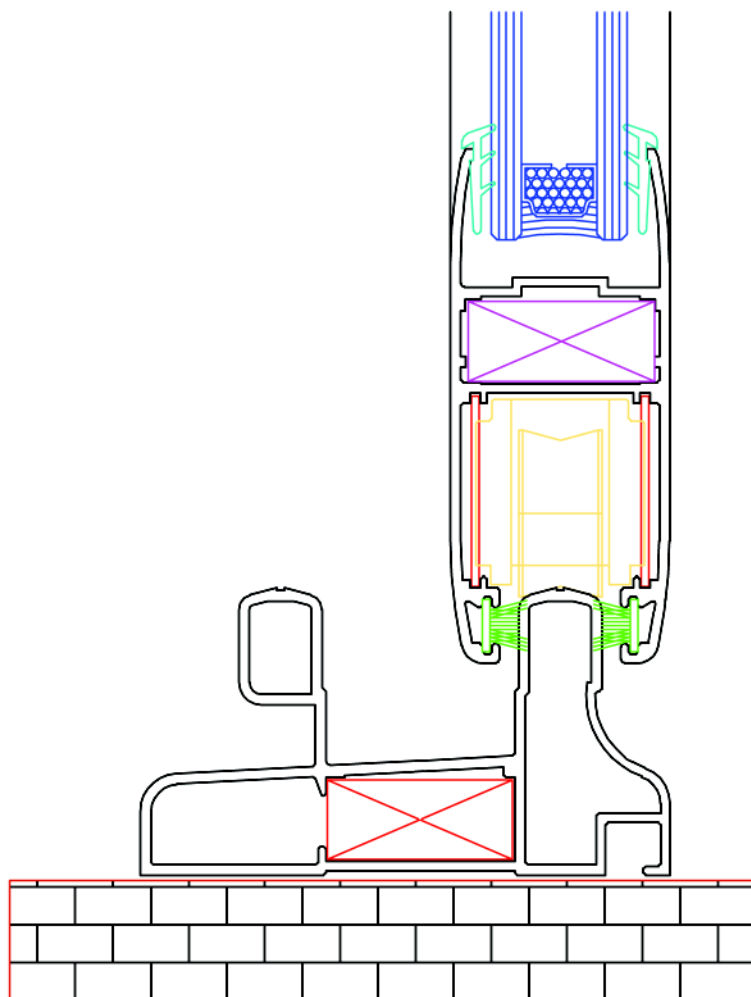

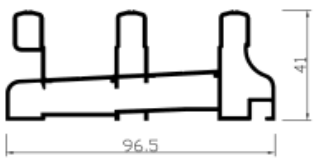
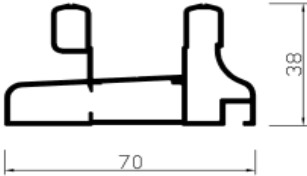
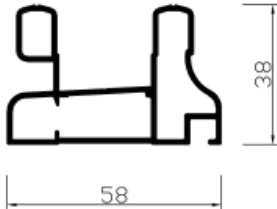
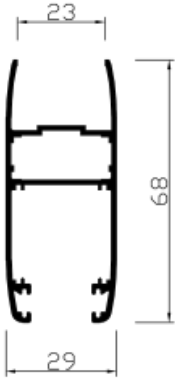
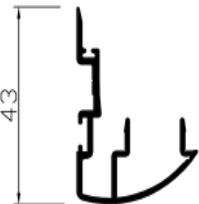
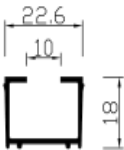
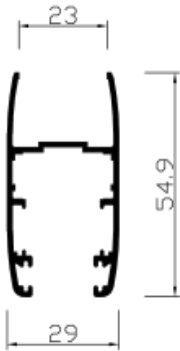
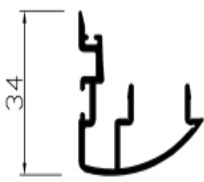
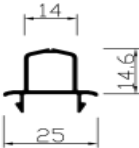
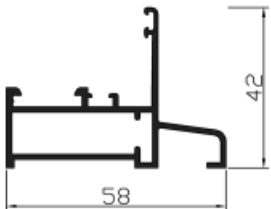
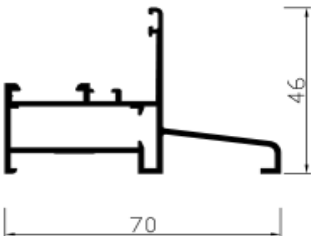
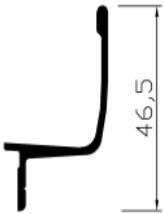

 <p>Ref. 70000 Marco perimetral 3 carriles</p>	 <p>Ref. 70001 Marco perimetral 70 mm.</p>	 <p>Ref. 70002 Marco perimetral 58 mm.</p>	 <p>Ref. 70003 Hoja perimetral.</p>
 <p>Ref. 70004 Tapeta cruce para hoja 70003.</p>	 <p>Ref. 70006 Reductor vidrio.</p>	 <p>Ref. 70013 Hoja pequeña perimetral.</p>	 <p>Ref. 70014 Tapeta cruce hoja 70013.</p>
 <p>Ref. 70016 Perfil 4 hojas.</p>	 <p>Ref. 65029 Marco fijos 58 mm.</p>	 <p>Ref. 70009 Marco fijos 70 mm.</p>	 <p>Ref. 21044 Perfil goterón.</p>

Perfiles extrusionados en aleación 6060 (EN 573-3)
Estado de suministro T-5 (EN 755-2)
Tolerancias de dimensiones y espesores según norma EN 755-9

Los ensayos han sido realizados en ISTDIL (Roma), en una ventana de dos hojas de medidas 1600 x 1400 mm., con los siguientes resultados:

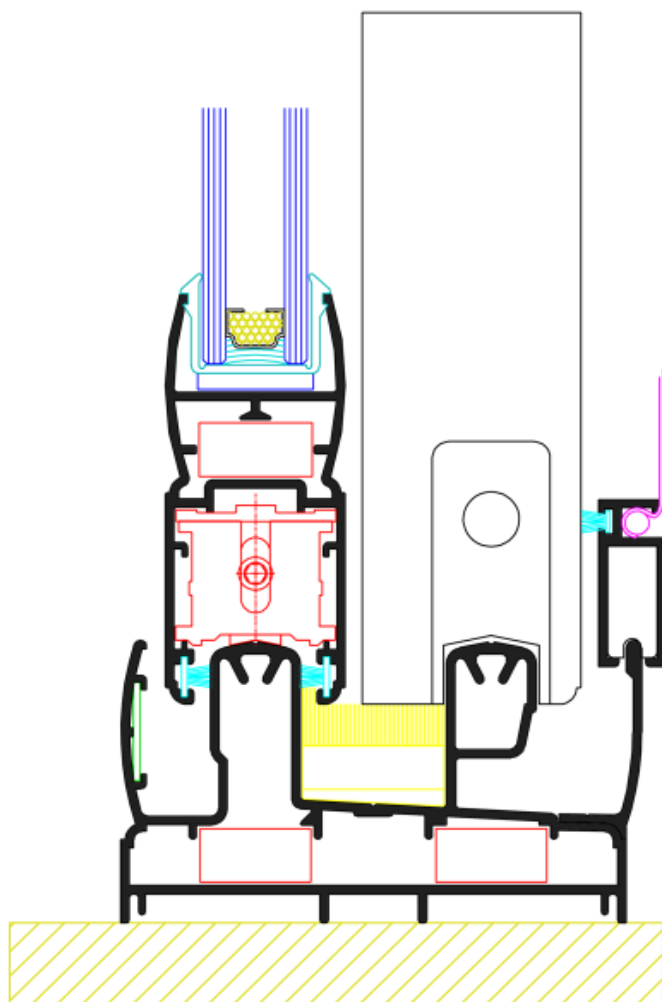
Permeabilidad al agua	Clase A-2
Estanqueidad al agua	Clase E-3
Resistencia al viento	Clase V-2a

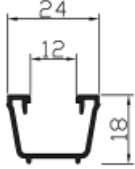
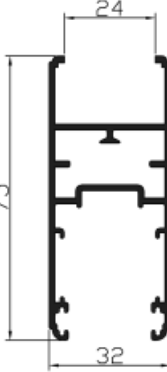
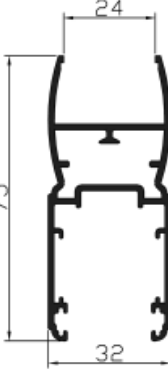
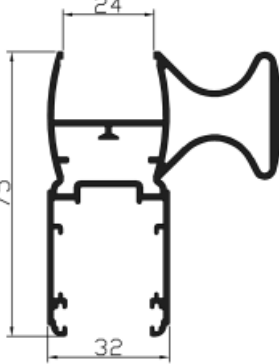
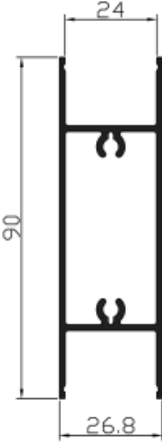
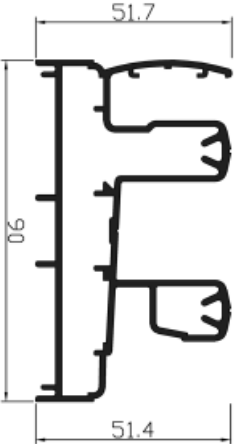

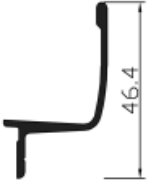
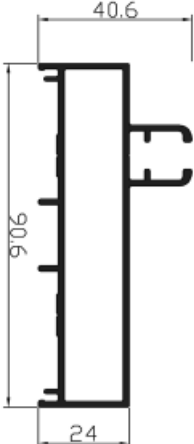
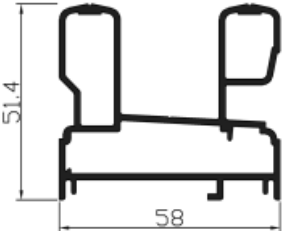
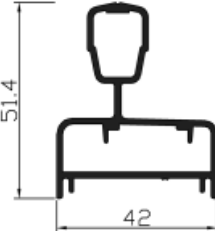
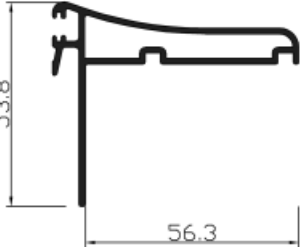
 <p>Ref 21019 Reductor galce vidrio</p>	 <p>Ref 21033 Hoja recta</p>	 <p>Ref 21034 Hoja curva</p>	 <p>Ref 21035 Hoja reforzada</p>
 <p>Ref 21038 Franja vidrio directo</p>	 <p>Ref 21041 Marco 90 mm corte perimetral o corte recto</p>	 <p>Ref 21043 Perfil tapajuntas</p>	 <p>Ref 21044 Perfil exterior mosquitera *consultar</p>
 <p>Ref 21045 Marco lateral 90 mm</p>	 <p>Ref 21048 Marco perimetral</p>	 <p>Ref 21049 Marco monorraíl</p>	 <p>Ref 21054 Perfil cruce pared monorraíl</p>

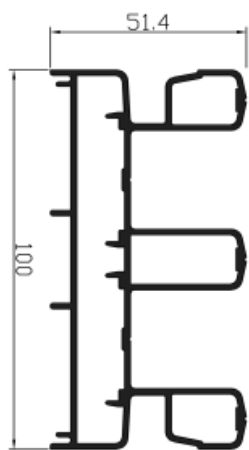

Ref. **21055**
Marco tres carriles perimetral

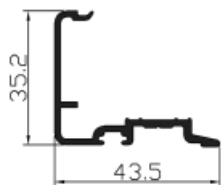

Ref. **21058**
Perfil cruce

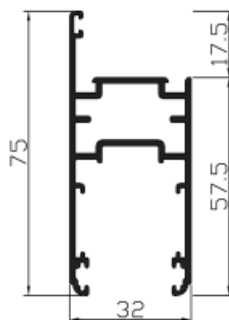

Ref. **21059**
Hoja ajunquillada



Ref. **21060**
Perfil de junquillo

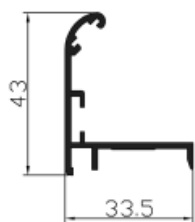

Ref. **21350**
Angulo para registro



Ref. **21351**
Base registro



Ref. **21984**
Perfil recogida de aguas

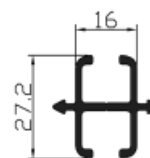

Ref. **21985**
Perfil acoplamiento 4 hojas

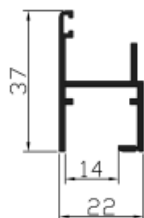

Ref. **24444**
Perfil cajón registro

Perfiles extrusionados en aleación 6060 (EN 573-3)
Estado de suministro T-5 (EN 755-2)
Tolerancias de dimensiones y espesores según norma EN 755-9

Los ensayos han sido realizados en ISTDIL (Roma), en una ventana de dos hojas de medidas 1600 x 1400 mm., con los siguientes resultados:

Permeabilidad al agua	Clase A-2
Estanqueidad al agua	Clase E-3
Resistencia al viento	Clase V-2a

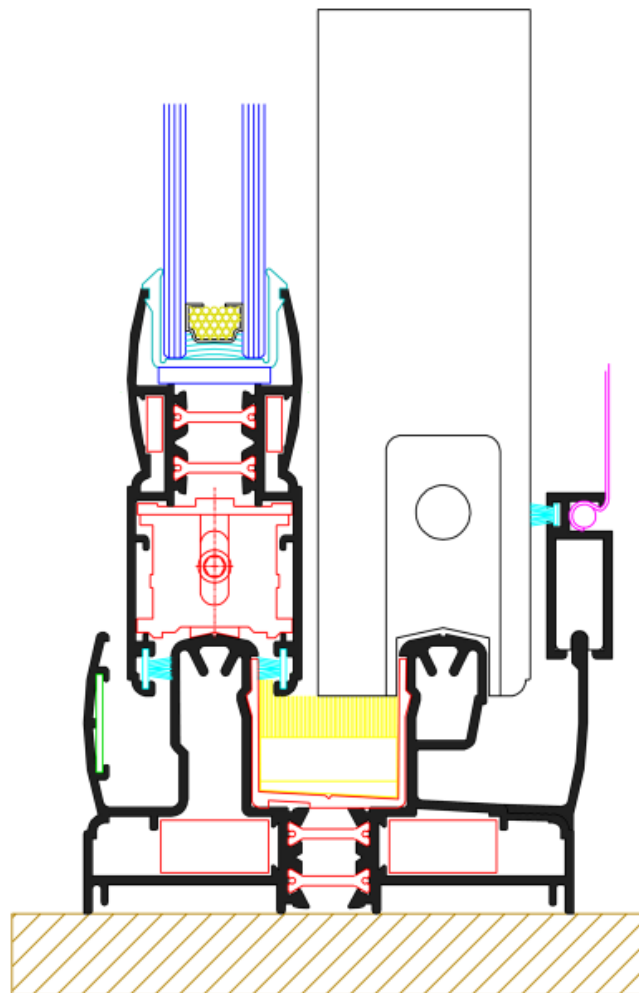

Atención, existe la posibilidad de realizar acabados en bicolor,
***consultar**



Ref. **21043**
Perfil tapajuntas

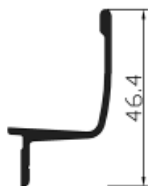

Ref. **21044**
Perfil exterior mosquitera
***consultar**



Ref. **21060**
Perfil de junquillo

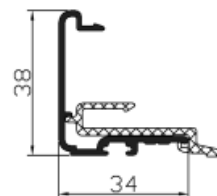

Ref. **21068**
Perfil cruce

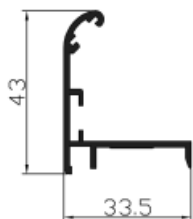

Ref. **21350**
Angulo para registro



Ref. **21351**
Base registro



Ref. **21984**
Perfil recogida de aguas

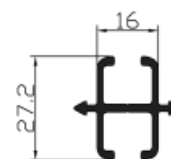

Ref. **21985**
Perfil acoplamiento 4 hojas

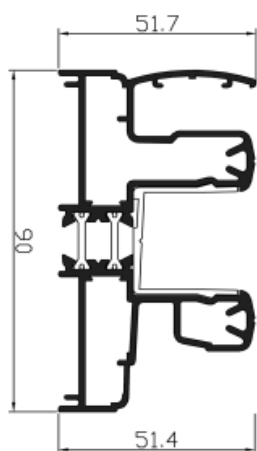

Ref. **22401**
Marco 90 mm corte perimetral o
corte recto

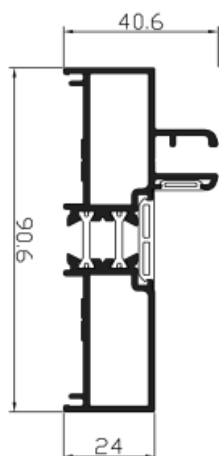

Ref. **22404**
Marco lateral 90 mm

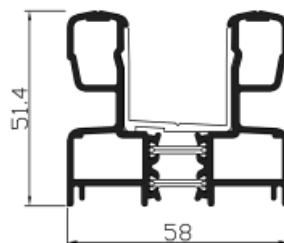

Ref. **22406***
Marco perimetral

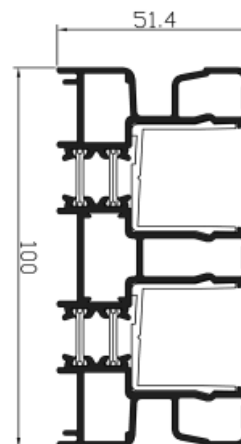

Ref. **22408**
Marco tres carriles perimetral

Corredera Abithal Runner tt





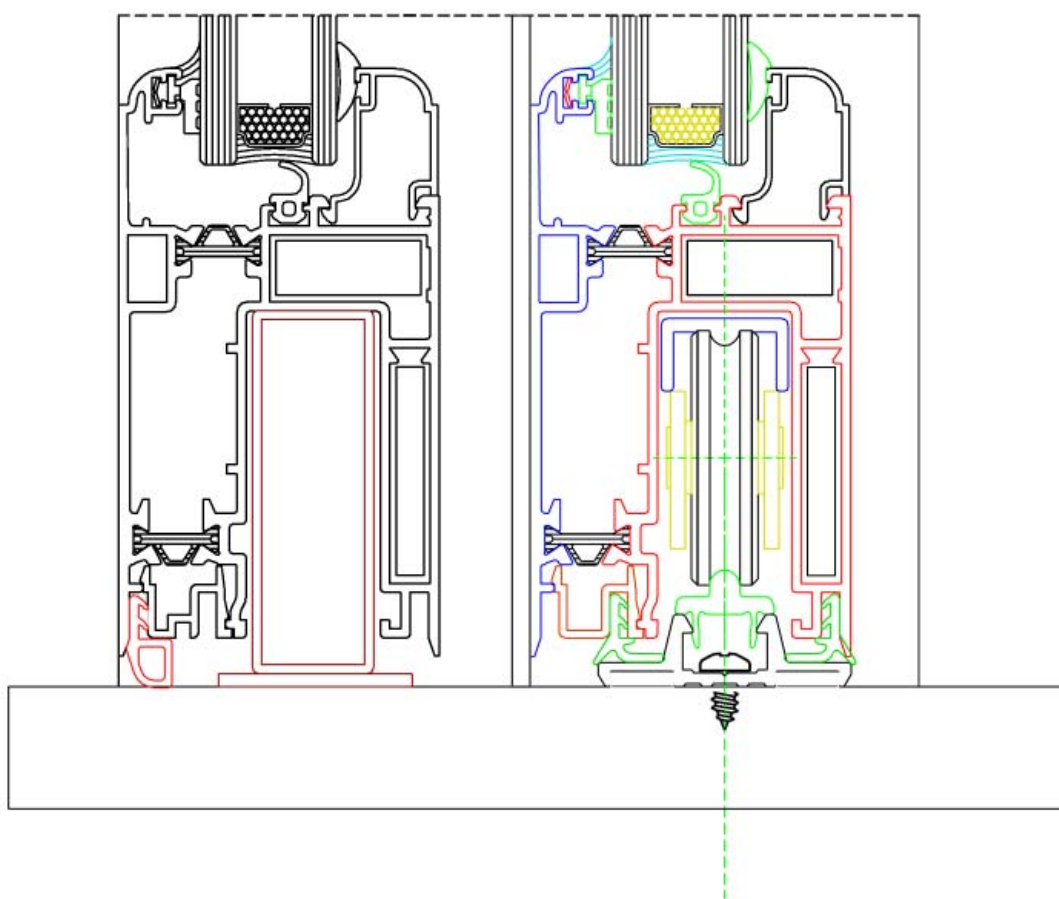

<p>Ref. 22410* Hoja recta</p>	<p>Ref. 22411 Hoja curva</p>	<p>Ref. 22412 Hoja reforzada</p>	<p>Ref. 22413 Hoja ajunquillada</p>
<p>Ref. 24444 Perfil cajón registro</p>	<p>Ref. 4GT71 Poliamida marco</p>	<p>Ref. 4GT72 Poliamida hoja</p>	<p>Ref. 4GT75 Poliamida perfil 4 hojas</p>

Perfiles extrusionados en aleación 6060 (EN 573-3)
Estado de suministro T-5 (EN 755-2)
Tolerancias de dimensiones y espesores según norma EN 755-9

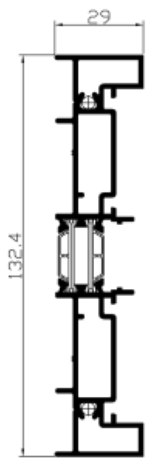
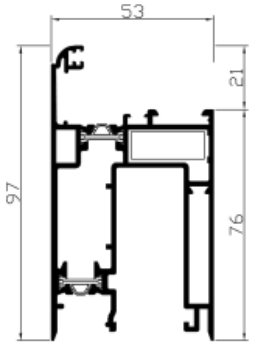
Los ensayos estan pendientes de realizarse, por ser una serie que está en fase de desarrollo.

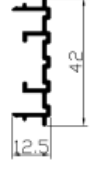
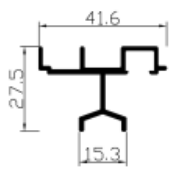
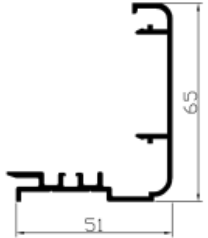
Permeabilidad al agua	Serie en desarrollo
Estanqueidad al agua	Serie en desarrollo
Resistencia al viento	Serie en desarrollo

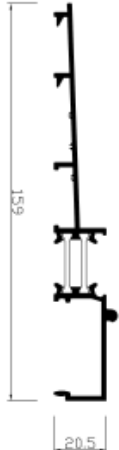
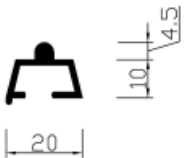

 <p>Ref. 22425 Marco lateral</p>	 <p>Ref. 22426 Hoja elevable</p>	 <p>Ref. 21960 Perfil cierre marco lateral</p>	 <p>Ref. 21961 Tapeta lateral marco</p>
 <p>Ref. 21962 Guia superior</p>	 <p>Ref. 21963 Tapeta cruce</p>	<p>* Perfiles solamente en acabado anodizado plata.</p>  <p>Ref. 40BNXX20 Guia inferior</p>	<p>* Perfiles solamente en acabado anodizado plata.</p>  <p>Ref. 40BNYY20 Base guía inferior</p>
<p>* Perfiles solamente en acabado anodizado plata.</p>  <p>Ref. N22115 Marco inferior</p>	<p>* Perfiles solamente en acabado anodizado plata.</p>  <p>Ref. N22315 Guia inferior acoplamiento</p>	<p>* Perfiles solamente en acabado anodizado plata.</p>  <p>Ref. N22316 Base acoplamiento</p>	

Perfiles extrusionados en aleación 6063 (UNE - 38337)
Estado de suministro T5
Tolerancias de dimensiones y espesores según norma UNE 38066

No se dispone de ensayos, en caso de ser necesarios se deberán realizar por el instalador

Permeabilidad al agua
Estanqueidad al agua
Resistencia al viento

Pendiente de clasificación
Pendiente de clasificación
Pendiente de clasificación

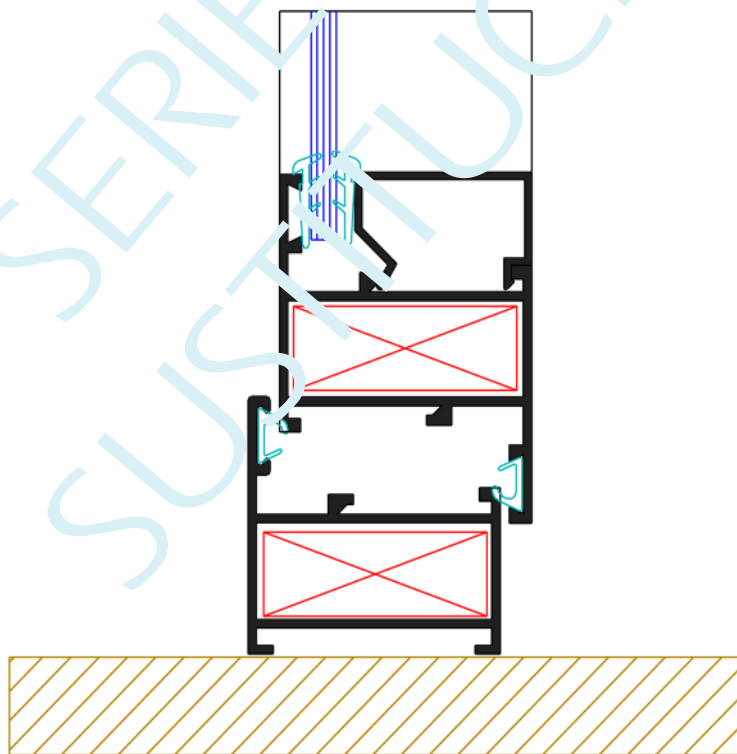

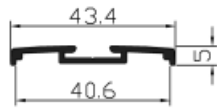

Ref **482**
Perfil tapeta vaivén

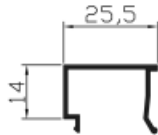

Ref **3410**
Junquillo de 25,5 mm
* Consultar stock

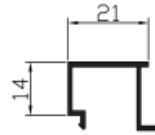

Ref **3910**
Junquillo de 21 mm
* Consultar stock

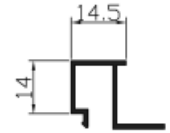

Ref **3911**
Junquillo de 14,5 mm

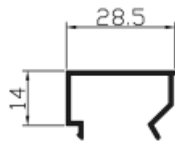

Ref **4343**
Junquillo de 28,5 mm
* Consultar stock

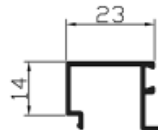

Ref **4379**
Junquillo de 23 mm

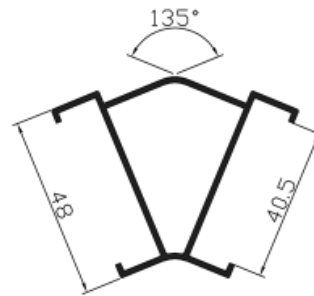

Ref **8273**
Perfil esquinero 135°

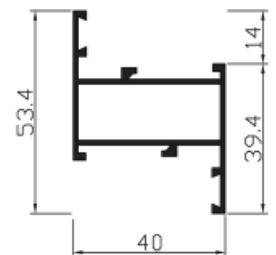

Ref **10401**
Marco con tapajuntas o hoja practicable

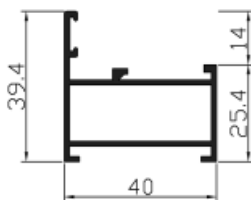

Ref **10405**
Marco sin tapajuntas

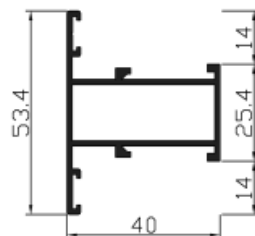

Ref **10409**
Perfil travesaño

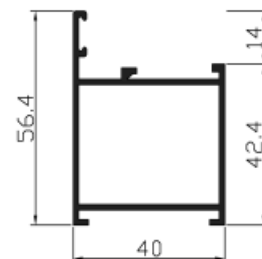

Ref **10420**
Marco puerta sin tapajuntas

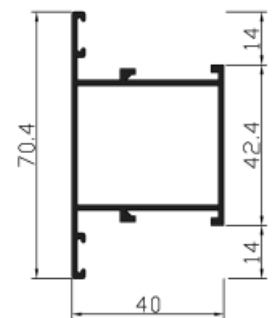

Ref **10423**
Perfil travesaño

serie en
sustitución

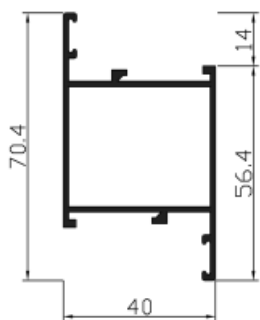

Ref. **10439**
Marco puerta con tapajuntas /
hoja puerta

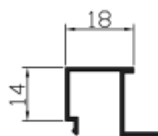

Ref. **11537**
Junquillo de 18 mm

Perfiles extrusionados en aleación 6063 (UNE - 38337)
Estado de suministro T-5
Tolerancias de dimensiones y espesores según norma UNE 38066

Los ensayos han sido realizados en Ornago (Milán), en una ventana de dos hojas de medidas 1500 x 1360 mm., con los siguientes resultados

Permeabilidad al agua	Clase A-3
Estanqueidad al agua	Clase E-3
Resistencia al viento	Clase V-2

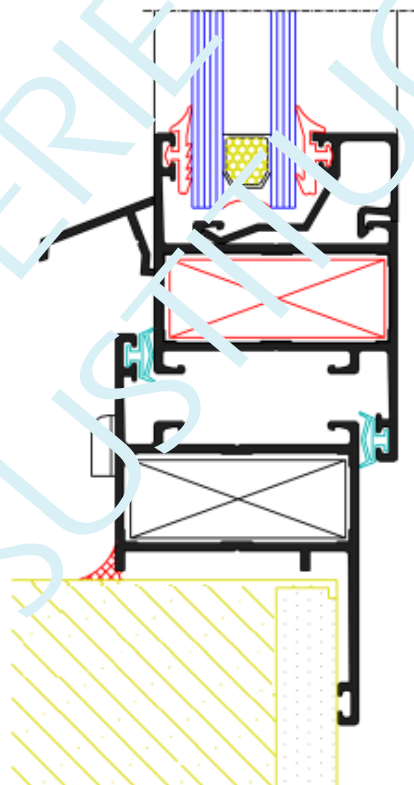

Serie en
sustitución



Ref. **i9720**
Junquillo de punto redondo de 14 mm con grapa

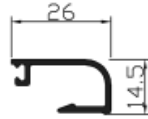

Ref. **i9721**
Junquillo de punto redondo de 26 mm con grapa

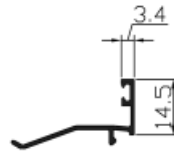

Ref. **i9727**
Junquillo recto de 3,4 mm

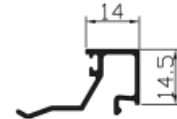

Ref. **i9728**
Junquillo recto de 14 mm

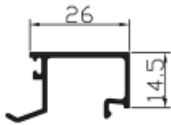

Ref. **i9729**
Junquillo recto de 26 mm

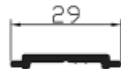

Ref. **i9730**
Pletina accionamiento

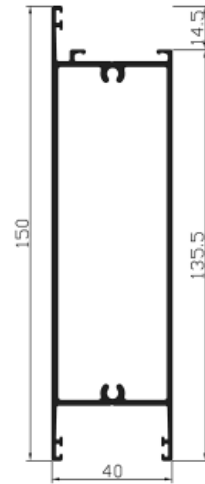

Ref. **i9737**
Perfil de zócalo



Ref. **i9738**
Perfil de franja 150 mm

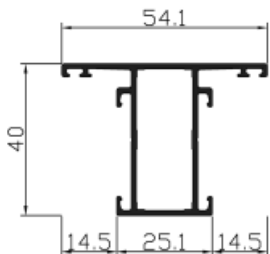

Ref. **i9744**
Hoja abertura exterior o travesaño de 54,1 mm

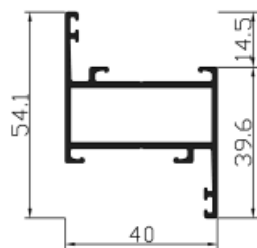

Ref. **i9745**
Hoja practicable

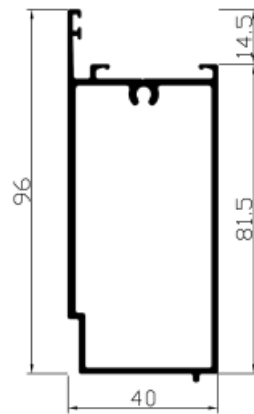



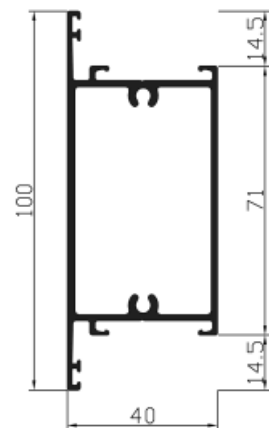

Ref. **26194**
Suplemento zócalo para hoja perimetral

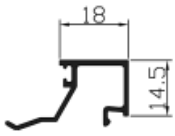
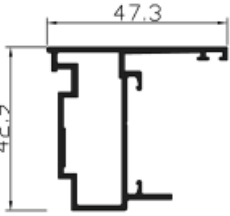
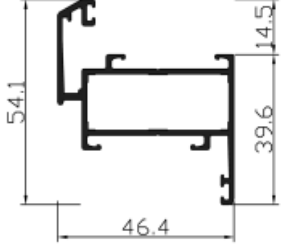
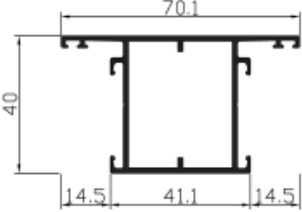
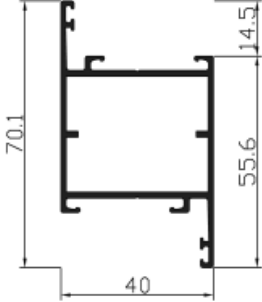
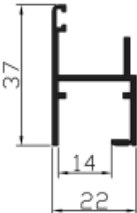

Ref. **i9739**
Travesaño 100 mm

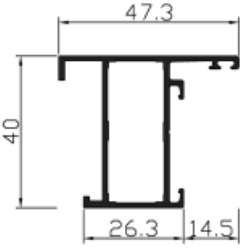
Series en
sustitución

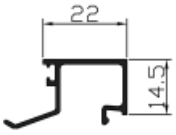
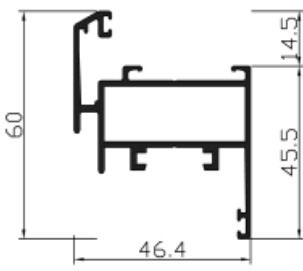
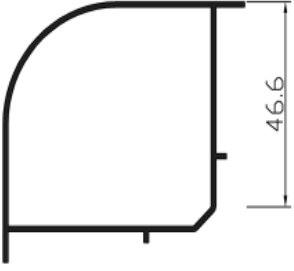
 <p>Ref. 21687 Junquillo recto de 18 mm</p>	 <p>Ref. 21688 Acoplamiento dos hojas</p>	 <p>Ref. 21689 Hoja practicable</p>	 <p>Ref. 21697 Hoja puerta abertura exterior o travesaño de 70,1 mm</p>
 <p>Ref. 21699 Hoja puerta practicable</p>	 <p>Ref. 24444 Perfil cajón registro</p>	 <p>Ref. 24551 Base registro</p>	 <p>Ref. 26176 Acoplamiento pivotante</p>
 <p>Ref. 26183 Perfil tapeta marco</p>	 <p>Ref. 26184 Junquillo recto de 22 mm</p>	 <p>Ref. 26191 Hoja oscilobatiente</p>	 <p>Ref. 26192 Perfil cantonero 90°</p>

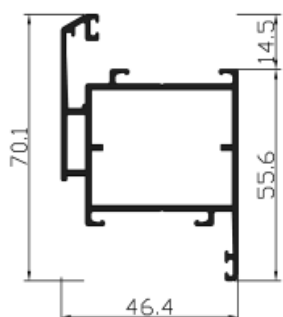

Ref. **26195**
Perfil puerta practicable

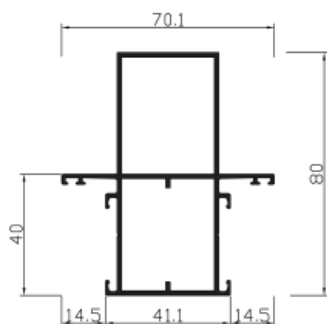

Ref. **26196**
Perfil rigidizador



Ref. **26197**
Junquillo de punto redondo de 14 mm clipado

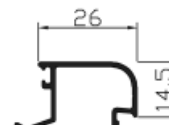

Ref. **26198**
Junquillo de punto redondo de 26 mm clipado

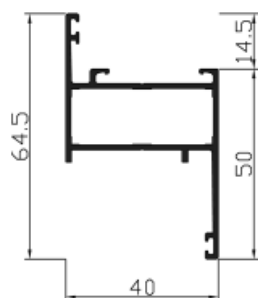

Ref. **26200**
Marco con tapajuntas

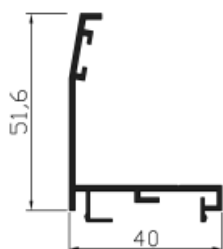

Ref. **27599**
Angulo de registro de 51,6 mm

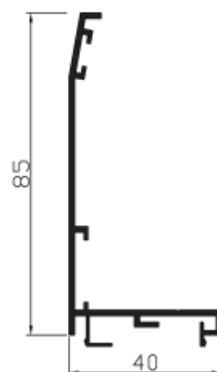

Ref. **27600**
Angulo de registro de 85 mm

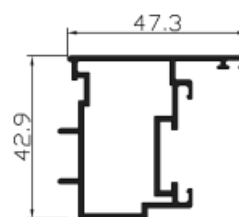

Ref. **30056**
Acoplamiento dos hojas oscilobatiente

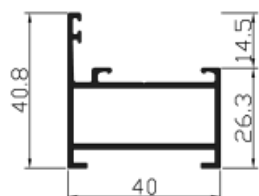

Ref. **30061**
Marco sin tapajuntas

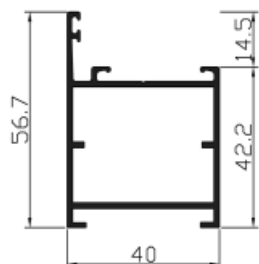

Ref. **30066**
Marco puerta sin tapajuntas

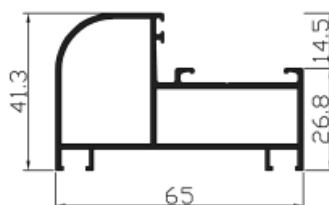

Ref. **65009**
Perfil marco fijo

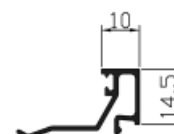

Ref. **26185**
Junquillo recto de 10 mm

Perfiles extrusionados en aleación 6060 (EN 573-3)
Estado de suministro T-5 (EN 755-2)
Tolerancias de dimensiones y espesores según norma EN 755-9

Los ensayos han sido realizados en ISTDIL (Roma), en una ventana de dos hojas de medidas 1200 x 1400 mm., con los siguientes resultados:

Permeabilidad al agua	Clase A-3
Estanqueidad al agua	Clase E-3
Resistencia al viento	Clase V-2a

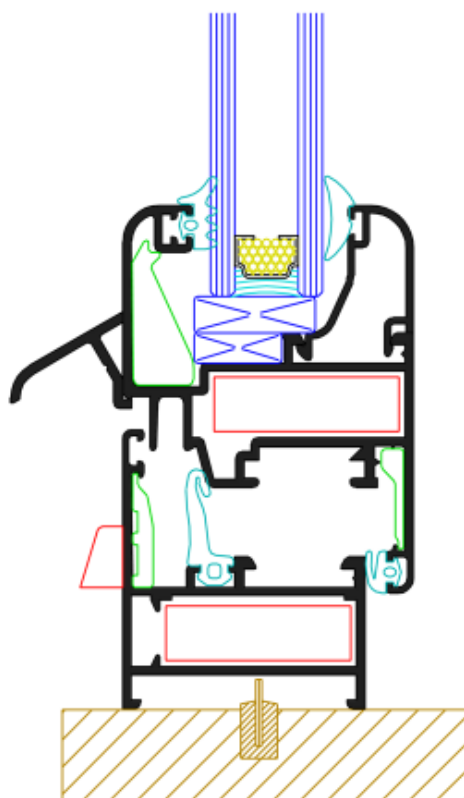



Ref. **20788**
Pletina accionamiento cremo.

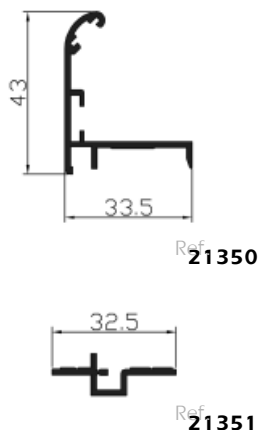

Ref. **21350-21351**
21350 -> Angulo para registro.
21351 -> Base para registro.

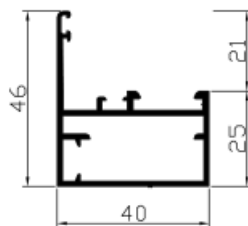

Ref. **27003**
Marco sin tapajuntas.



Ref. **21579**
Perfil vierteaguas

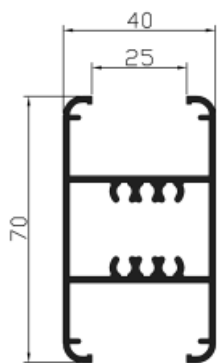

Ref. **24406**
Travesaño vidrio directo

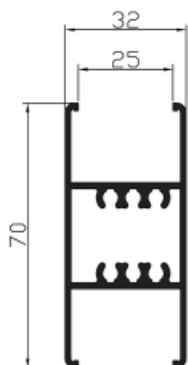

Ref. **24426**
Travesaño vidrio directo

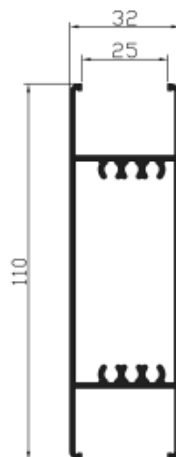

Ref. **24427**
Travesaño vidrio directo

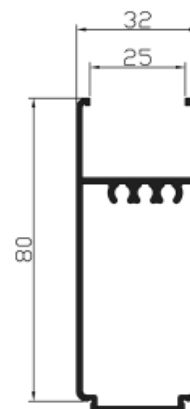

Ref. **24428**
Suplemento zócalo vidrio directo

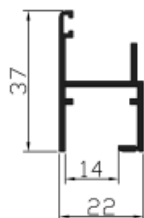

Ref. **24444**
Perfil cajón registro

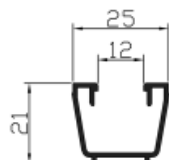

Ref. **24446**
Reductor galce vidrio

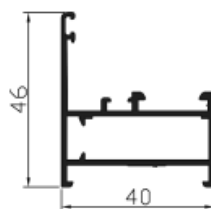

Ref. **27000**
Marco sin tapajuntas

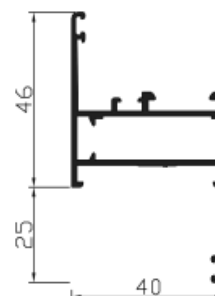

Ref. **27001**
Marco con tapajuntas

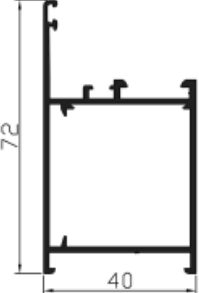
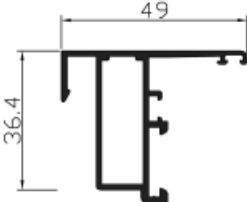
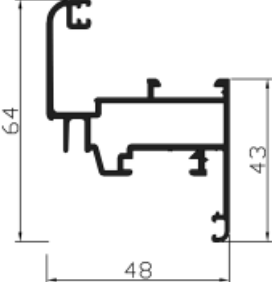
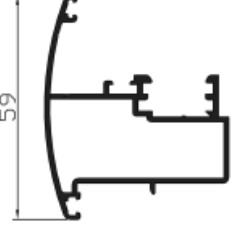
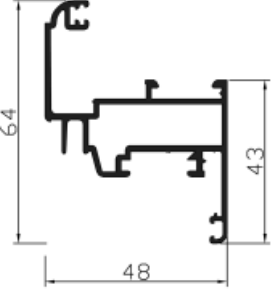
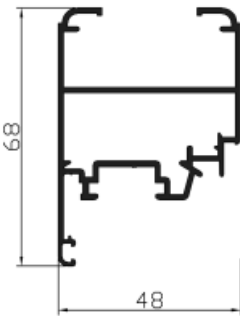
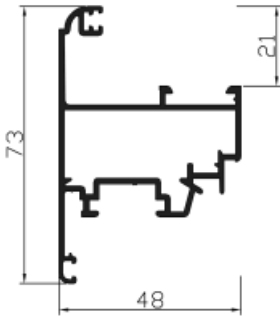
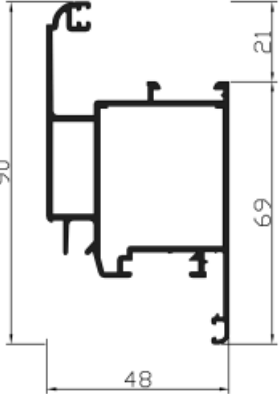
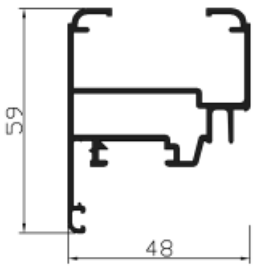
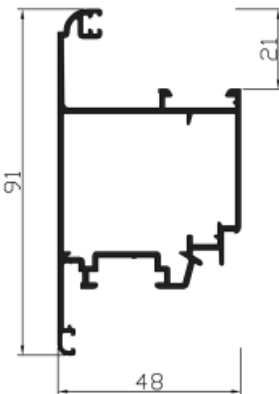
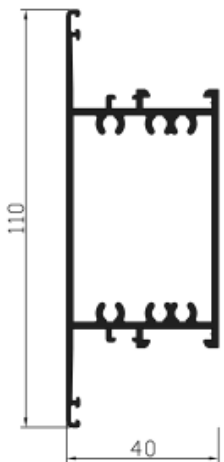
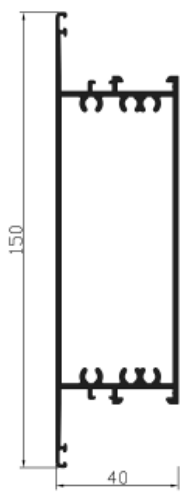
 <p>Ref 27002 Marco puerta sin tapajuntas</p>	 <p>Ref 27008 Perfil inversor marco</p>	 <p>Ref 27030 Hoja ajunquillada</p>	 <p>Ref 27031 Perfil acoplamiento central</p>
 <p>Ref 27032 Hoja ajunquillada</p>	 <p>Ref 27033 Hoja vidrio directo</p>	 <p>Ref 27034 Hoja apertura exterior</p>	 <p>Ref 27035 Hoja balconera ajunquillada</p>
 <p>Ref 27036 Hoja vidrio directo</p>	 <p>Ref 27038 Hoja balconera apertura exterior</p>	 <p>Ref 27061 Travesaño / franja</p>	 <p>Ref 27062 Travesaño / franja</p>

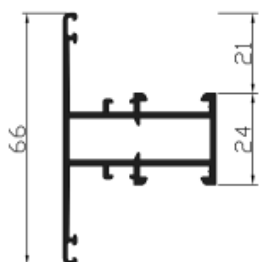

Ref. **27063**
Travesaño

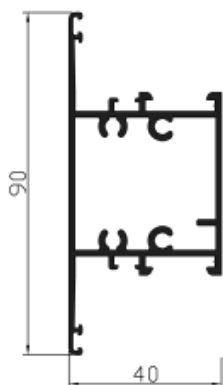

Ref. **27064**
Travesaño

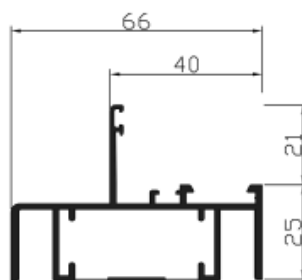

Ref. **27066**
Semi rigidizador

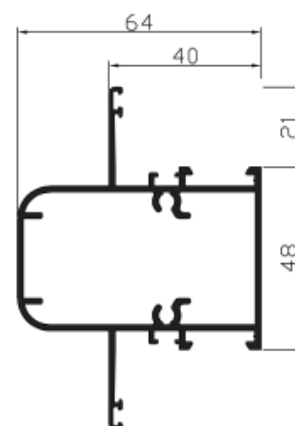

Ref. **27067**
Rigidizador



Ref. **27528**

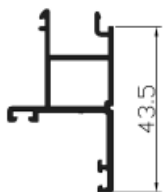

Ref. **27531**

Ref. **27528-27531**
Remate inferior franja / zócalo

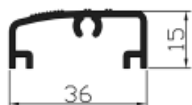

Ref. **27530**
Remate suelo

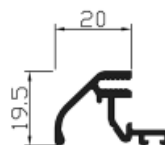

Ref. **27532**

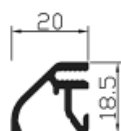

Ref. **27537**

Ref. **27532-27537**
Perfil vierteaguas para zócalo

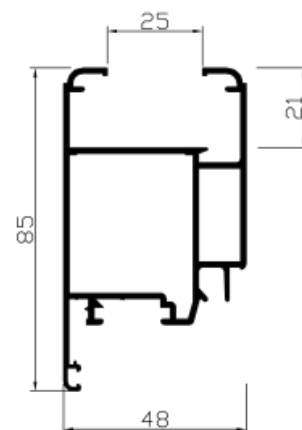

Ref. **27040**
Hoja balconera vidrio directo

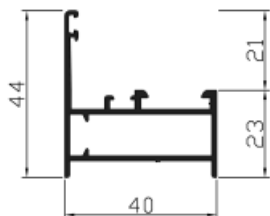

Ref. **21362**
Marco ventana

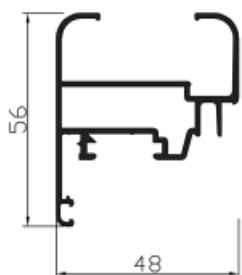

Ref. **21363**
Hoja ventana

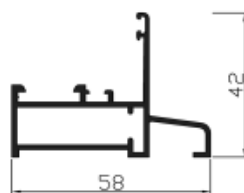

Ref. **65029**

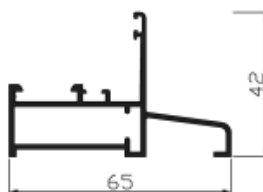

Ref. **65030**

Ref. **65029-65030**
Perfiles para fijos, compatibles con Euro 40 y junquillos cámara europ.

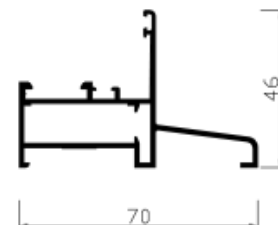

Ref. **70009**
Perfil para fijos, compatible con Euro 40 y junquillos cámara europ.

Perfiles extrusionados en aleación 6060 (EN 573-3)
Estado de suministro T-5 (EN 755-2)
Tolerancias de dimensiones y espesores según norma EN 755-9

Los ensayos han sido realizados en ISTDIL (Roma), en una ventana de dos hojas de medidas 1300 x 1300 mm., con los siguientes resultados:

Permeabilidad al agua	Clase A-3
Estanqueidad al agua	Clase E-4
Resistencia al viento	Clase V-3

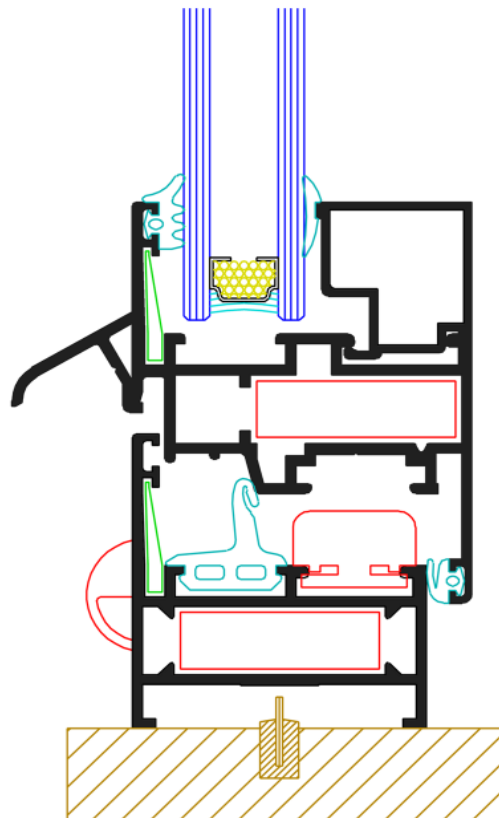

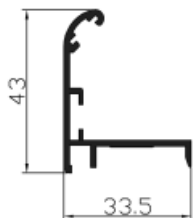

Ref. **21350**
Angulo para registro



Ref. **21351**
Base registro

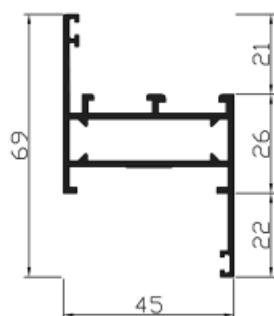

Ref. **21501**
Marco ventana con tapajuntas

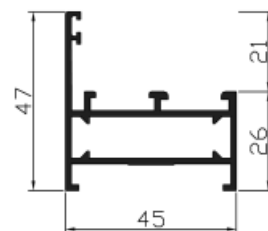

Ref. **21503**
Marco ventana

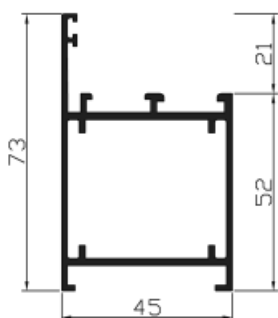

Ref. **21507**
Marco puerta

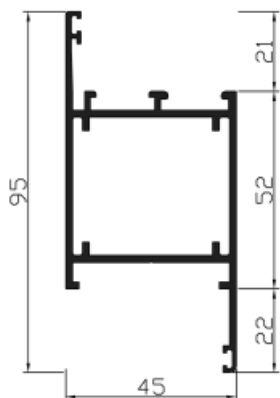

Ref. **21508**
Marco puerta con tapajuntas

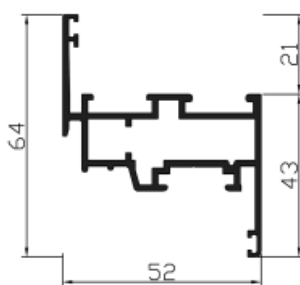

Ref. **21511-24544**
Hoja ventana
* Consultar stock

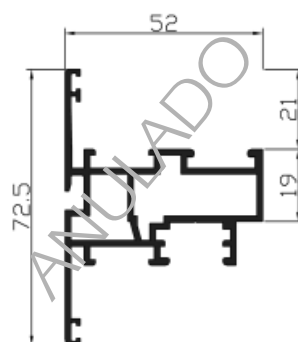

Ref. **21512**
Doble hoja ventana
* Consultar stock

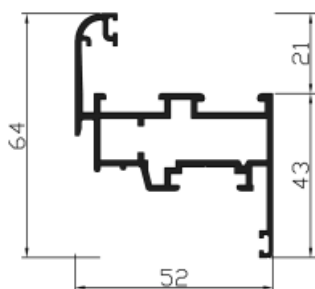

Ref. **21513-24540**
Hoja ventana con punto redondo
* Consultar stock

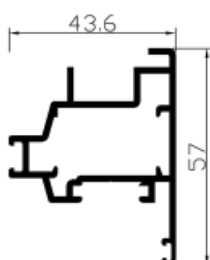

Ref. **21521**
Acoplamiento pivotante

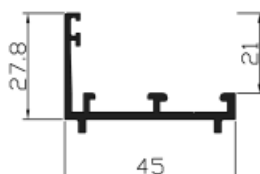

Ref. **21522**
Tapeta marco

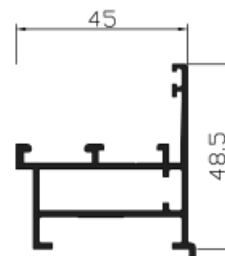

Ref. **21523**
Inversor marco

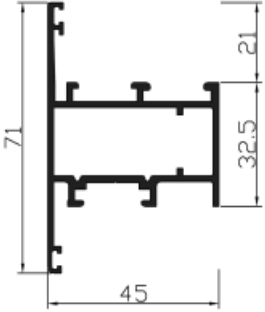
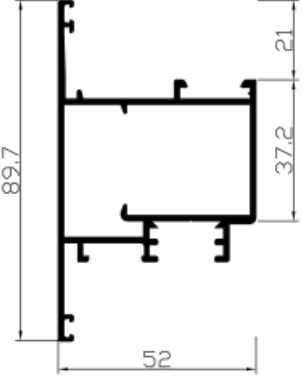
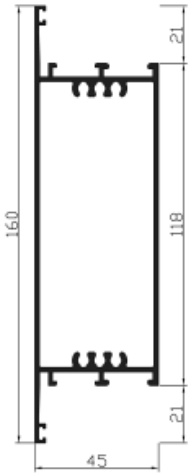
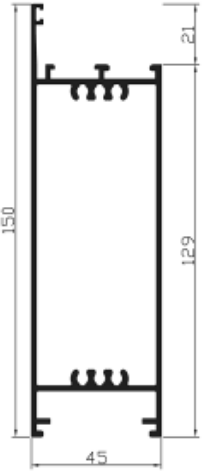
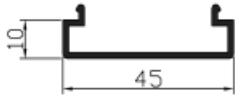
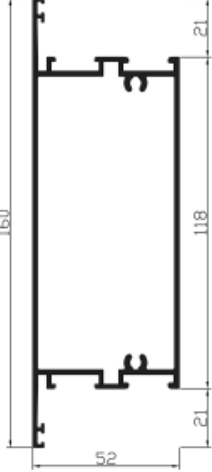
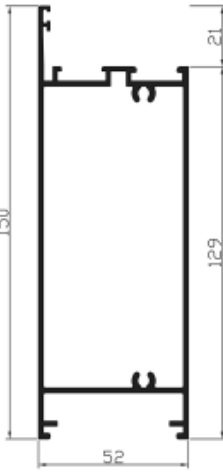
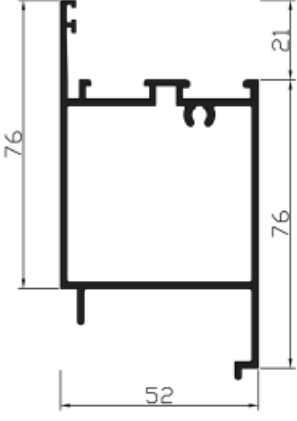
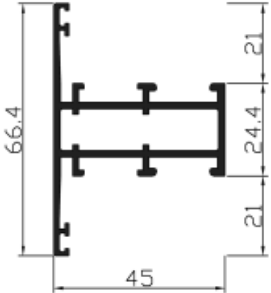
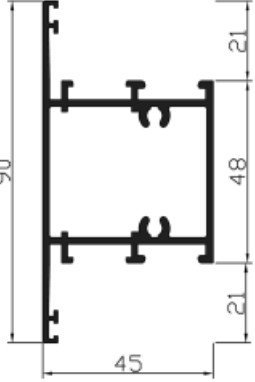
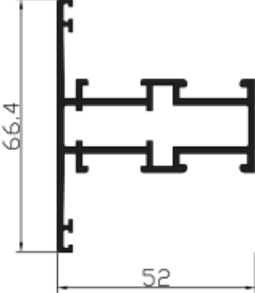
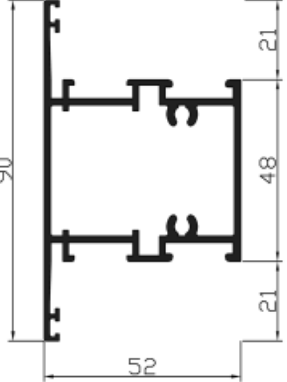
 <p>Ref 21524 Hoja ventana apertura exterior</p>	 <p>Ref 21527 Hoja pivotante</p>	 <p>Ref 21532 Franja</p>	 <p>Ref 21534 Zócalo</p>
 <p>Ref 21535 Suplemento zócalo</p>	 <p>Ref 21537 Franja hoja</p>	 <p>Ref 21538 Zócalo hoja</p>	 <p>Ref 21539 Suplemento zócalo</p>
 <p>Ref 21541 Travesaño</p>	 <p>Ref 21542 Travesaño</p>	 <p>Ref 21543 Travesaño</p>	 <p>Ref 21544 Travesaño</p>

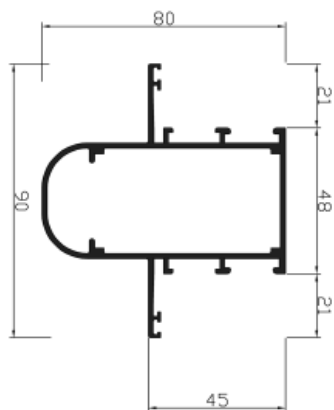

Ref. **21545**
Rigidizador

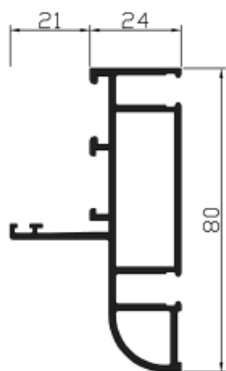

Ref. **21546**
Semi rigidizador



Ref. **21576**
Complemento zócalo

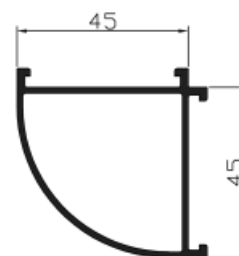

Ref. **21577**
Esquinero

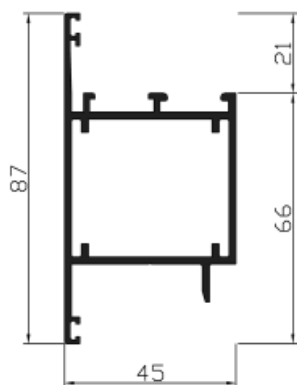

Ref. **21588**
Hoja puerta apertura exterior

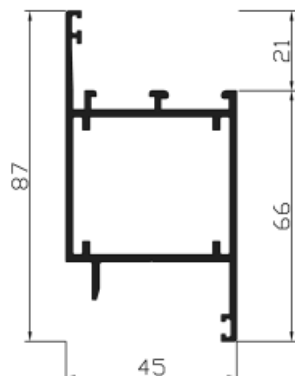

Ref. **21589**
Hoja puerta apertura interior

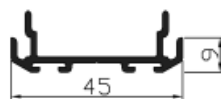

Ref. **21591**
Tapeta vaivén



Ref. **21592**
Tapeta vaivén

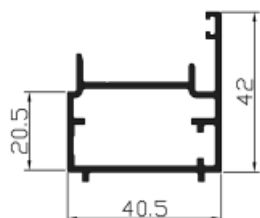

Ref. **21593**
Inversor marco

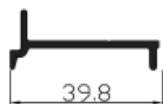

Ref. **21594**
Tapeta marco

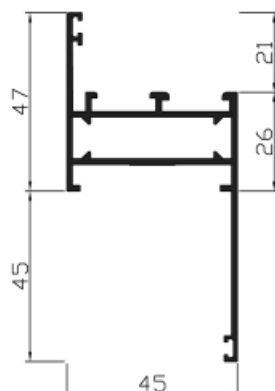

Ref. **21611**
Marco con tapajunas

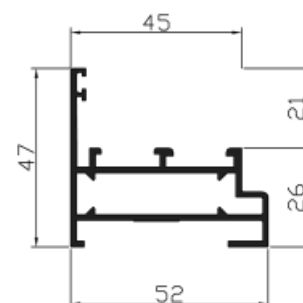

Ref. **21612**
Marco coplanario

<p>Ref. 21618 Marco con tapajuntas</p>	<p>Ref. 24427 Franja vidrio directo * Consultar stock</p>	<p>Ref. 24428 Suplemento zócalo vidrio directo * Consultar stock</p>	<p>Ref. 21629 Suplemento zócalo</p>
<p>Ref. 21630-24426 Travesaño vidrio directo * Consultar stock</p>	<p>Ref. 21636-24543 Hoja balconera * Consultar stock</p>	<p>Ref. 21642 Hoja balconera</p>	<p>Ref. 21644-24539 Hoja vidrio directo * Consultar stock</p>
<p>Ref. 21645 Hoja balconera apertura exterior</p>	<p>Ref. 21646-24546 Hoja balconera * Consultar stock</p>	<p>Ref. 21659 Suplemento zócalo</p>	<p>Ref. 24529-21791 Travesaño * Consultar stock</p>

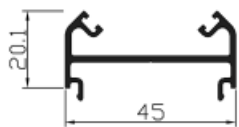

Ref. **21795**
Acoplamiento tubo redondo

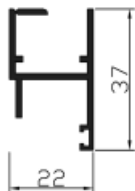

Ref. **24444**
Perfil cajón registro

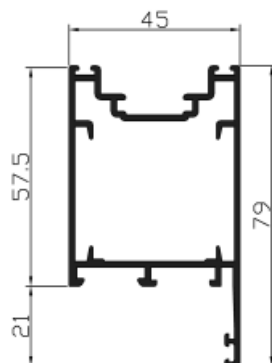

Ref. **24547**
Hoja vaivén
* Consultar stock

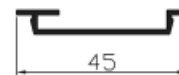

Ref. **24561**
Tapeta base registro

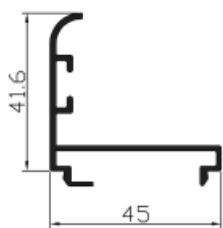

Ref. **24562**
Angulo registro 41,6 mm

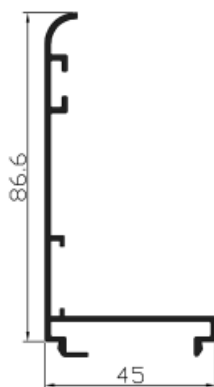

Ref. **24563**
Angulo registro 86,6 mm

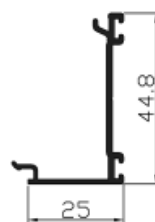

Ref. **24567**
Tapeta marco vaivén

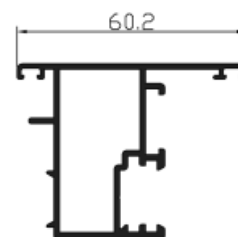

Ref. **21633-24573**
Acoplamiento central doble hoja
* Consultar

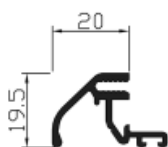

Ref. **2732**
Perfil vierteaguas para zócalo

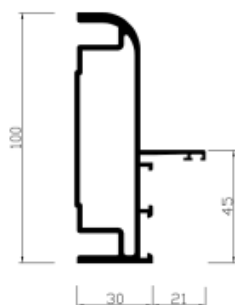

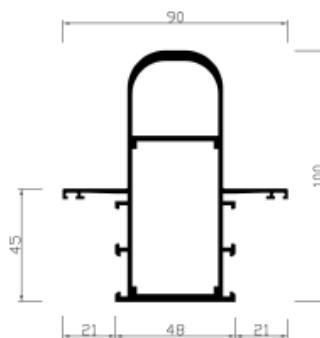

Ref. **24524**
Semi rigidizador

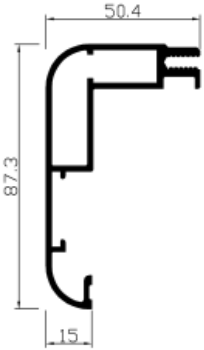
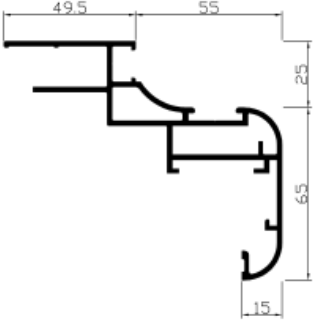
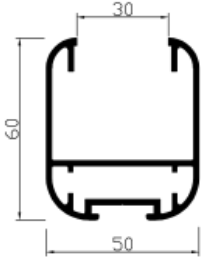
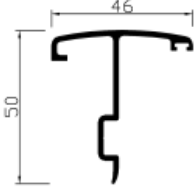
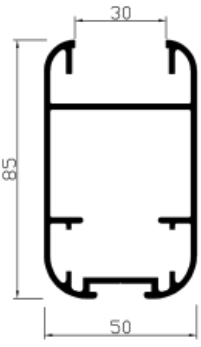
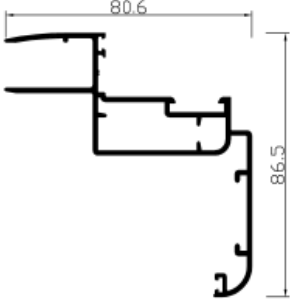
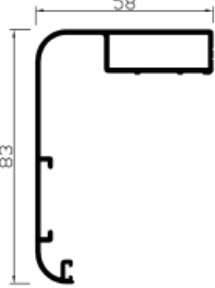

Ref. **24525**
Rigidizador

Practicable Abithal Open Green

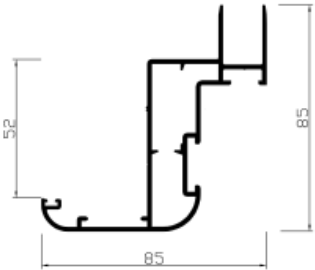
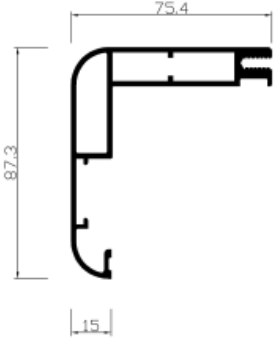
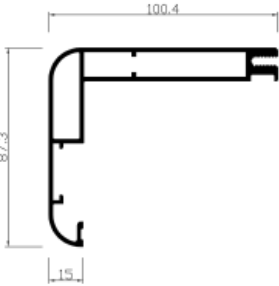
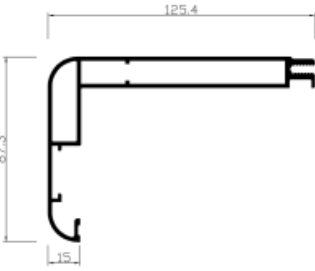
 <p>Ref. 121581 Semi marco exterior</p>	 <p>Ref. 121582 Semi marco interior</p>	 <p>Ref. 121585 Hoja</p>	 <p>Ref. 121596 Acoplamiento dos hojas</p>
 <p>Ref. 121685 Hoja reforzada</p>	 <p>Ref. 121692 Semi marco interior</p>	 <p>Ref. 121694 Semi marco exterior</p>	 <p>Ref. 121377 Semi marco exterior pared 60</p>
 <p>Ref. 121378 Semi marco interior pared 60</p>	 <p>Ref. 121681 Semi marco exterior</p>	 <p>Ref. 121682 Semi marco exterior</p>	 <p>Ref. 121683 Semi marco exterior</p>

Perfiles extrusionados en aleación 6060 (EN 573-3)
Estado de suministro T-5 (EN 755-2)
Tolerancias de dimensiones y espesores según norma EN 755-9

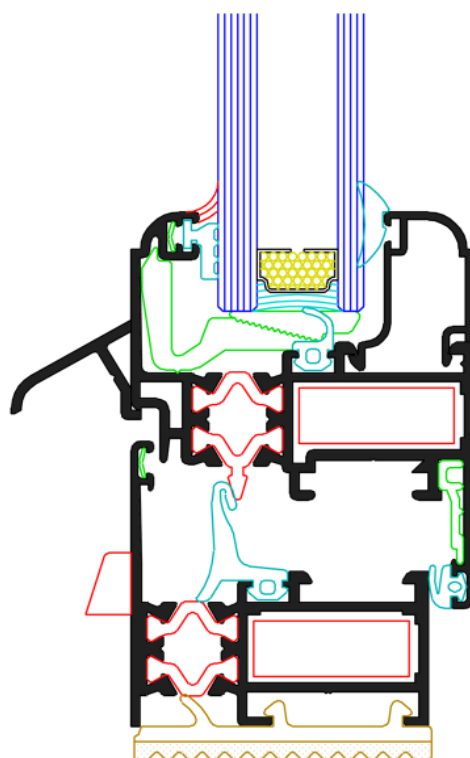

Los ensayos han sido realizados en ISTEDIL (Roma), en una ventana de dos hojas de medidas 1200 x 1400 mm., con los siguientes resultados:

Permeabilidad al agua	Clase A-3
Estanqueidad al agua	Clase E-4
Resistencia al viento	Clase V-3

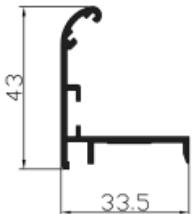

Atención, existe la posibilidad de realizar acabados en bicolor,
***consultar**

Practicable Abithal Euro-Keeper 45

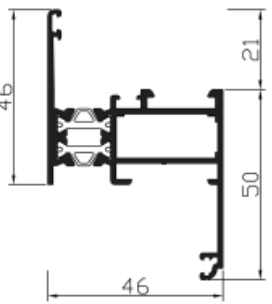
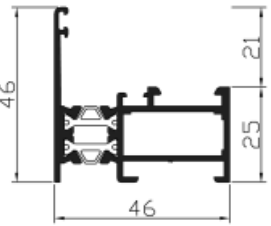
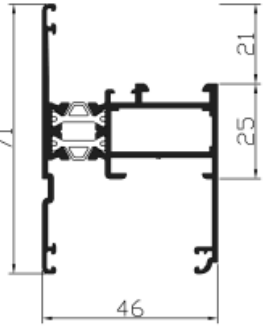
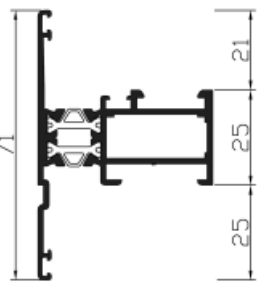
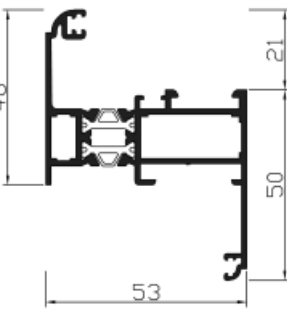
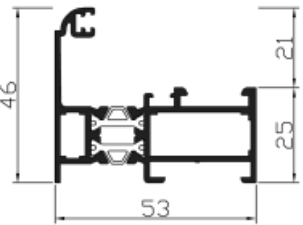
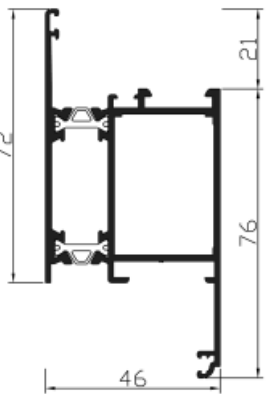
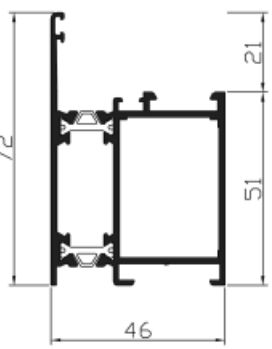
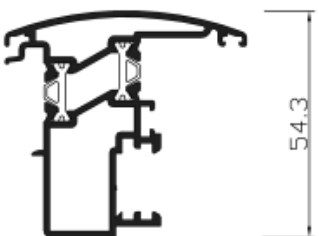
 <p>Ref. 20788 Pletina accionamiento cremona</p>	 <p>Ref. 21350 Angulo para registro</p>	 <p>Ref. 21531 Base registro</p>	 <p>Ref. 22700 Marco con tapajuntas</p>
 <p>Ref. 22701* Marco ventana</p>	 <p>Ref. 22702 Marco acoplamiento</p>	 <p>Ref. 22703 Marco con tapajuntas exterior</p>	 <p>Ref. 22704 Marco coplanario con tapajuntas</p>
 <p>Ref. 22705 Marco coplanario</p>	 <p>Ref. 22706 Marco puerta con tapajuntas</p>	 <p>Ref. 22707* Marco puerta</p>	 <p>Ref. 22733* Acoplamiento dos hojas</p>

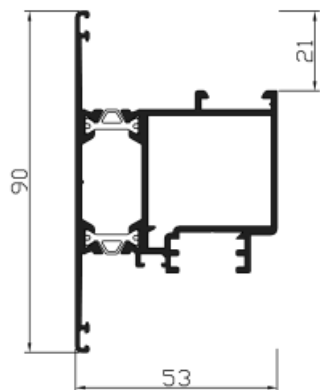

Ref. **22737**
Hoja pivotante

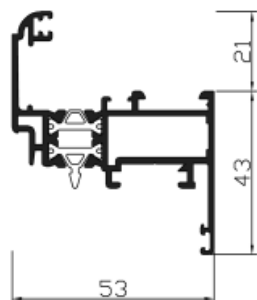

Ref. **22738***
Hoja ventana

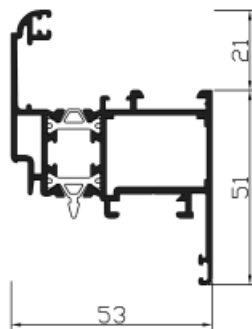

Ref. **22739***
Hoja ventana

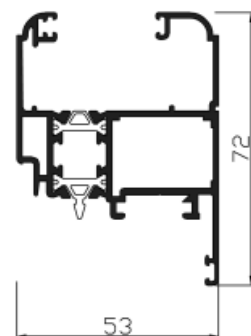

Ref. **22740**
Hoja ventana vidrio directo

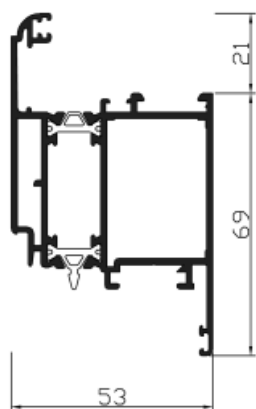

Ref. **22741***
Hoja balconera

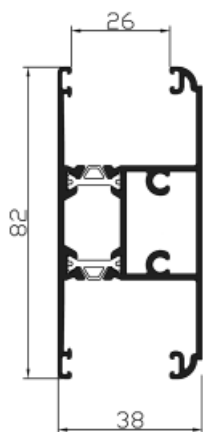

Ref. **22761**
Travesaño vidrio directo

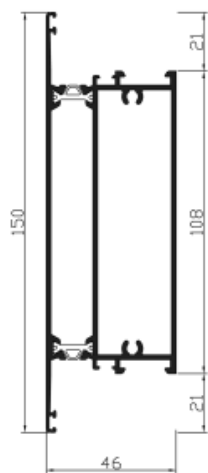

Ref. **22762**
Franja / zócalo

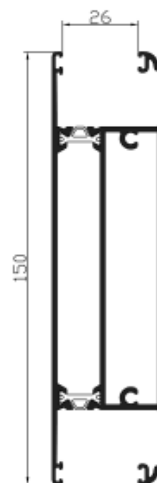

Ref. **22763**
Franja vidrio directo

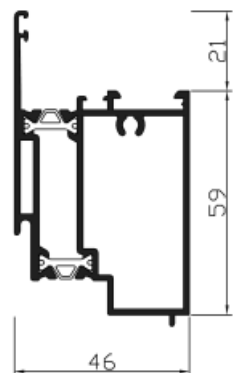

Ref. **22764**
Suplemento zócalo

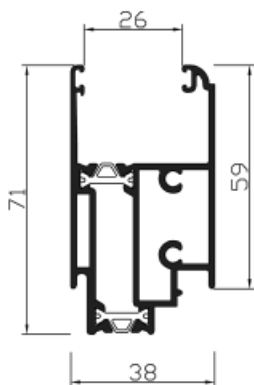

Ref. **22765**
Suplemento zócalo vidrio directo

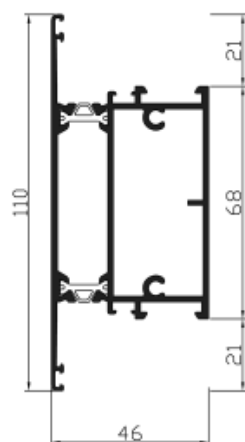



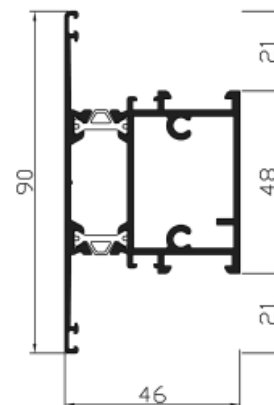

Ref. **22766**
Travesaño

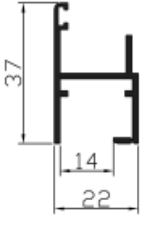
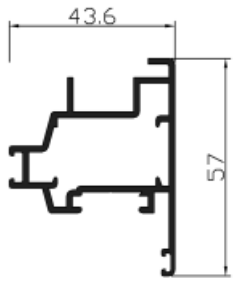
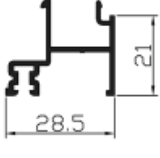
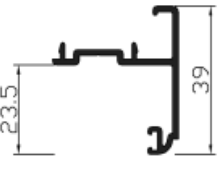
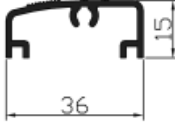
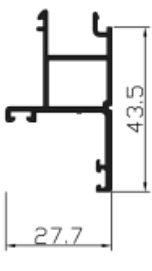

Ref. **22767***
Travesaño

¡¡ATENCIÓN!!.. EXISTE LA POSIBILIDAD DE REALIZAR ACABADOS EN BICOLOR

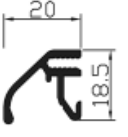
* PERFILES QUE SE PUEDEN LACAR EN BICOLOR

 <p>Ref. 24444 Perfil cajón registro</p>	 <p>Ref. 21521 Acoplamiento pivotante</p>	 <p>Ref. 27528 Remate inferior franja / zócalo</p>	 <p>Ref. 27529 Cartela marco coplanario</p>
 <p>Ref. 27530 Remate suelo</p>	 <p>Ref. 27531 Remate acoplamiento franja / zócalo</p>	 <p>Ref. 27533 Acoplamiento marco bisagra tenax</p>	 <p>Ref. 27537 Vierteaguas</p>
 <p>Ref. 27994 Remate suelo</p>			

Perfiles extrusionados en aleación 6060 (EN 573-3)
Estado de suministro T-5 (EN 755-2)
Tolerancias de dimensiones y espesores según norma EN 755-9

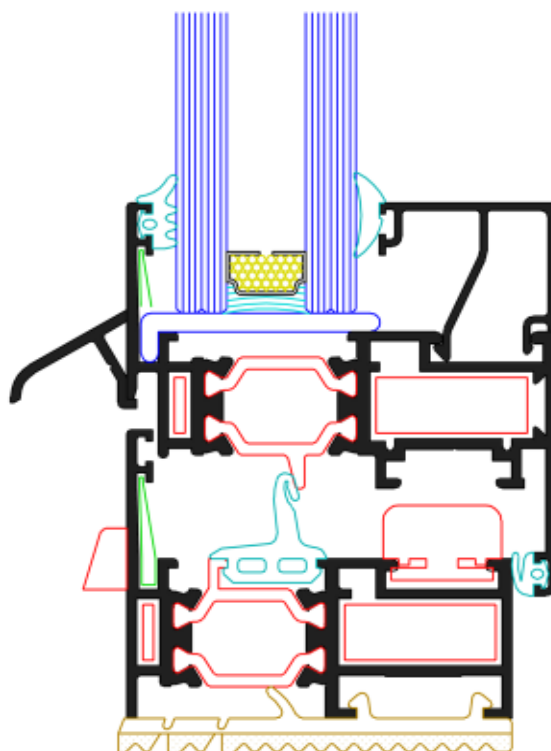

Los ensayos han sido realizados en ICITE (Milán), en una ventana de dos hojas de medidas 1300 x 1400 mm., con los siguientes resultados:

Permeabilidad al agua	Clase A-3
Estanqueidad al agua	Clase E-4
Resistencia al viento	Clase V-3

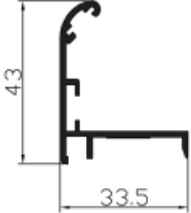
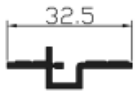
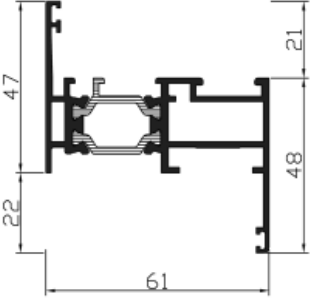
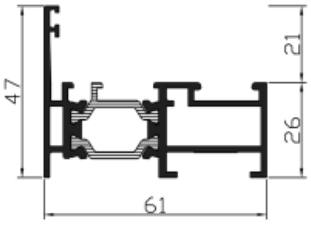
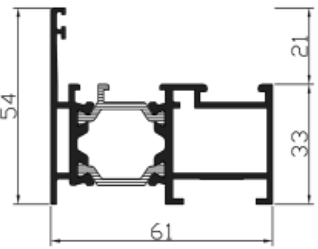
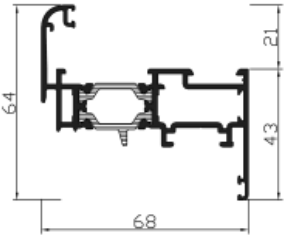
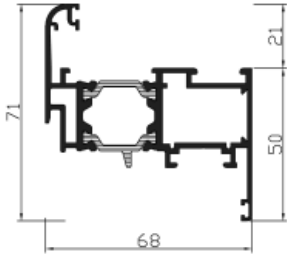
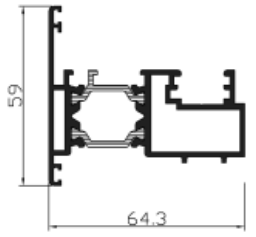
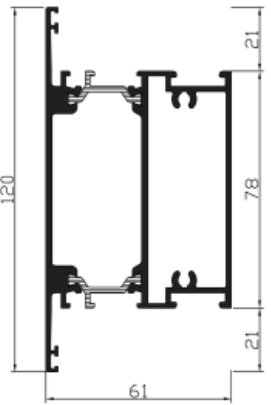
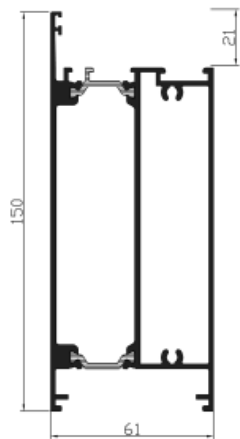

NOTA: LA MADERA SERÁ SIEMPRE ROBLE MACIZO NATURAL

Practicable Abithal Keeper 61-68

 <p>Ref. 21350 Angulo para registro</p>	 <p>Ref. 21351 Base registro</p>	 <p>Ref. 22050 Marco con tapajuntas * Consultar stock</p>	 <p>Ref. 22051 Marco ventana * Consultar stock</p>
 <p>Ref. 22053-22155 Marco ventana * Consultar stock</p>	 <p>Ref. 22062 Hoja ventana</p>	 <p>Ref. 22065 Hoja ventana</p>	 <p>Ref. 22067 Acoplamiento dos hojas</p>
 <p>Ref. 22070 Travesaño / franja</p>	 <p>Ref. 22073 Zócalo</p>	 <p>Ref. 22081 Acoplamiento zócalo</p>	 <p>Ref. 22083 Acoplamiento zócalo</p>

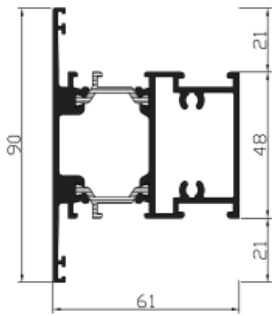

Ref. **22091**
Travesaño

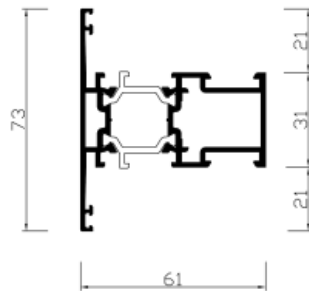

Ref. **22096**
Travesaño

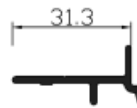

Ref. **22121**
Tapeta marco puerta

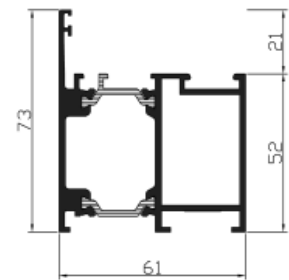

Ref. **22150**
Marco puerta

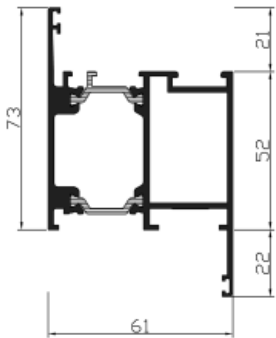

Ref. **22151**
Marco puerta con tapajuntas

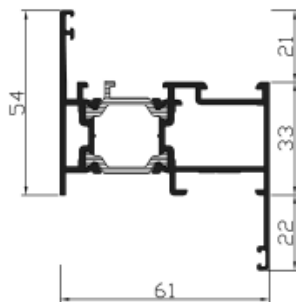

Ref. **22156**
Marco ventana con tapajuntas

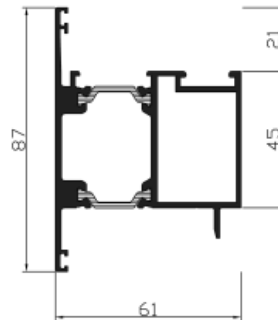

Ref. **22161**
Hoja puerta apertura exterior

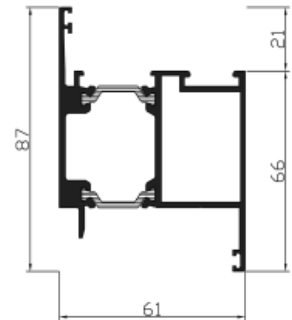

Ref. **22162**
Hoja puerta apertura interior

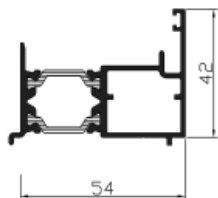

Ref. **22172**
Inversor marco puerta

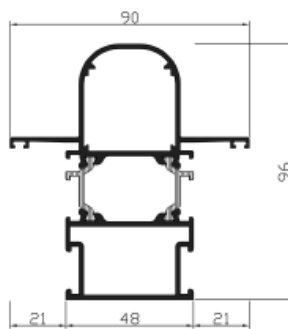

Ref. **22179**
Rigidizador

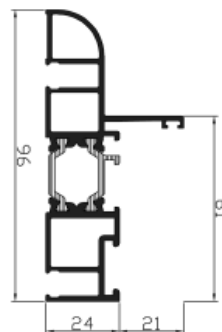



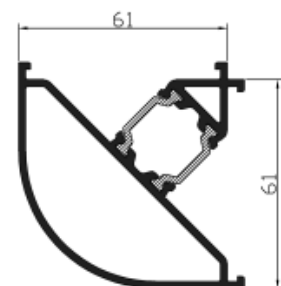

Ref. **22182**
Semi rigidizador

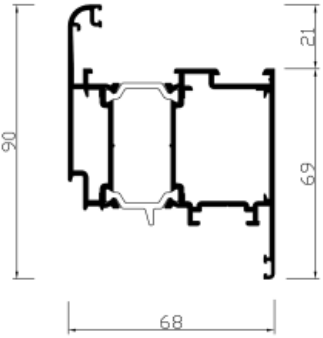

Ref. **22183**
Esquinero 90°

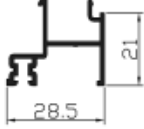
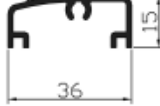
Practicable Abithal Keeper 61-68

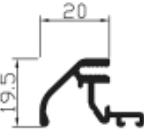
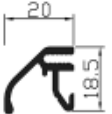
 <p>Ref. 22166 Hoja balconera</p>	 <p>Ref. 24444 Perfil cajón registro</p>	 <p>Ref. 27528 Remate inferior franja / zócalo</p>	 <p>Ref. 27530 Remate suelo</p>
 <p>Ref. 27531 Remate acoplamiento franja / zócalo</p>	 <p>Ref. 27532 Perfil vierteaguas para zócalo</p>	 <p>Ref. 27537 Vierteaguas</p>	

Perfiles extrusionados en aleación 6060 (EN 573-3)
Estado de suministro T-5 (EN 755-2)
Tolerancias de dimensiones y espesores según norma EN 755-9

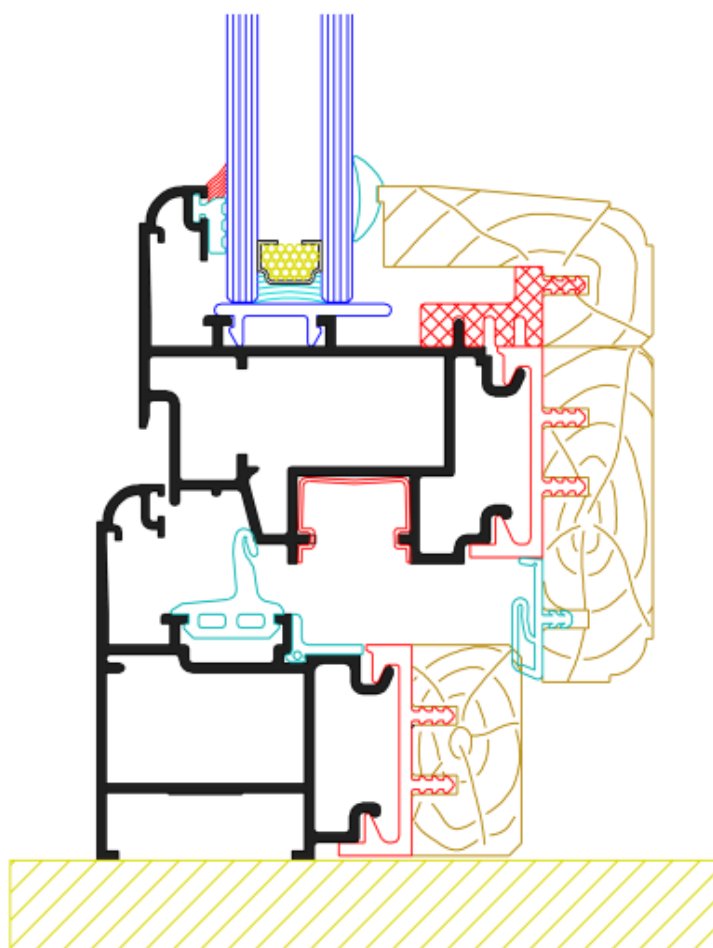

<p>Ref. 21901+7L2 Marco ventana con tapajuntas</p>	<p>Ref. 21901+7L3 Marco ventana</p>	<p>Ref. 21901+7L4 Marco ventana con tapajuntas</p>	<p>Ref. 21902+7L2 Marco puerta</p>
<p>Ref. 21902+7L4 Marco puerta con tapajuntas</p>	<p>Ref. 21903+7L3 Marco inferior corredera elevable</p>	<p>Ref. 21904+7L2 Marco superior corredera elevable</p>	<p>Ref. 21905+7L2 Marco lateral corredera elevable</p>
<p>Ref. 21911+7L2 Hoja ventana</p>	<p>Ref. 21912+7L0 Hoja balconera</p>	<p>Ref. 21913+7L1 Acoplamiento dos hojas</p>	<p>Ref. 21914+7L0 Hoja corredera elevable</p>

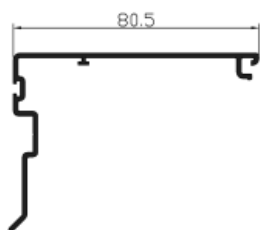

Ref **21921**
Perfil para cruce corredera

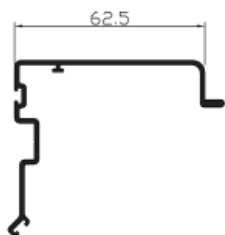

Ref **21922**
Perfil para cruce corredera

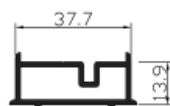

Ref **21923**
Acoplamiento marco lateral



Ref **21924**
Acoplamiento hoja corredera fija

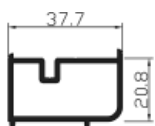

Ref **21925**
Encuentro cuatro hojas correderas

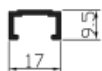

Ref **21926**



Ref **21927**
Estanqueidad corredera

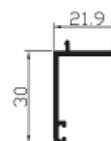

Ref **21928**
Tapajuntas exterior marco corredera

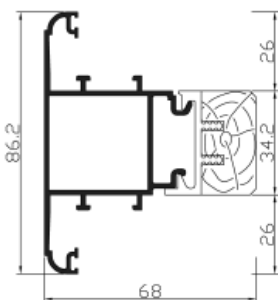

Ref **21941+7L3**
Travesaño marco

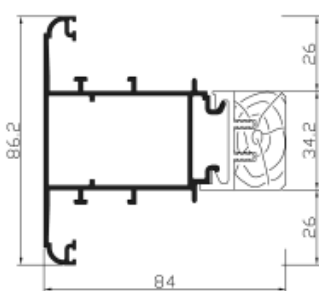

Ref **21942+7L3**
Travesaño hoja

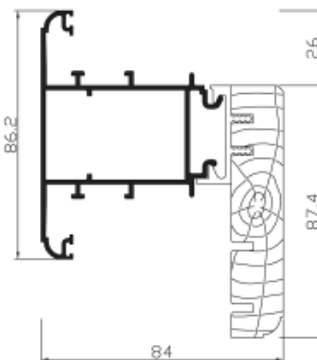

Ref **21942+7L4**
Suplemento zócalo



Ref **7L1**
Tapeta madera acoplamiento dos hojas



Ref **7L2**
Tapeta madera 54,4 mm



Ref **7L3**
Tapeta madera 34,2 mm



Ref **7L4**
Tapeta madera 87,4 mm

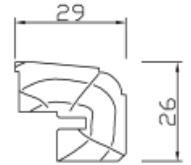

Ref **7L5**
Junquillo 29 mm

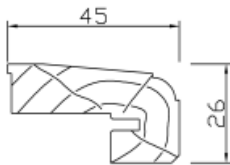

Ref **7L6**
Junquillo 45 mm

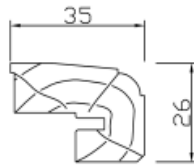

Ref **7L7**
Junquillo 35 mm

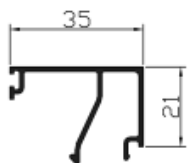

Ref. **20709**
Junquillo recto de 35 mm

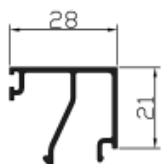

Ref. **20710**
Junquillo recto de 28 mm

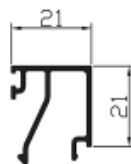

Ref. **20711**
Junquillo recto de 21 mm

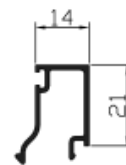

Ref. **20712**
Junquillo recto de 14 mm

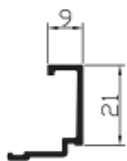

Ref. **21551**
Junquillo recto de 9 mm

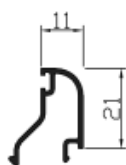

Ref. **21565**
Junquillo redondo de 11 mm clipado

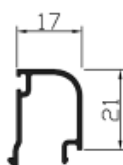

Ref. **21566**
Junquillo redondo de 17 mm clipado



Ref. **21567**
Junquillo redondo de 23 mm clipado

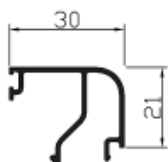

Ref. **21568**
Junquillo redondo de 30 mm clipado



Ref. **21675**
Junquillo redondo de 11 mm con grapa





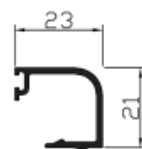

Ref. **21676**
Junquillo redondo de 17 mm con grapa

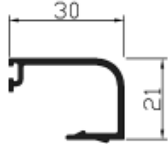

Ref. **21677**
Junquillo redondo de 23 mm con grapa

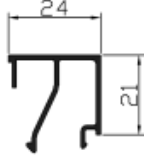
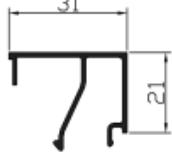
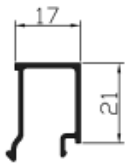
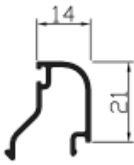
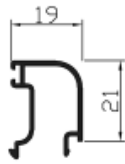
Junquillos cámara europea

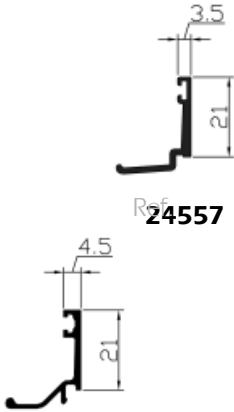
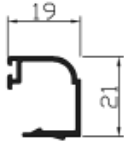
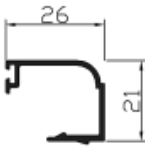
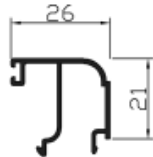
 <p>Ref. 21678 Junquillo redondo de 30 mm con grapa</p>	 <p>Ref. 21780 Junquillo redondo de 14 mm con grapa</p>	 <p>Ref. 21782 Junquillo recto de 24 mm</p>	 <p>Ref. 21783 Junquillo recto de 31 mm.</p>
 <p>Ref. 21786 Junquillo recto de 17 mm</p>	 <p>Ref. 21787 Junquillo redondo de 14 mm clipado</p>	 <p>Ref. 21789 Junquillo redondo de 19mm clipado</p>	 <p>Ref. 24558 Junquillo redondo de 19 mm con grapa</p>
 <p>Ref. 24557-20737 Junquillo recto de 3,5 mm Junquillo recto de 4,5 mm</p>	 <p>Ref. 124550 Junquillo redondo resalte de 19 mm con grapa</p>	 <p>Ref. 124551 Junquillo redondo resalte de 26 mm con grapa</p>	 <p>Ref. 124552 Junquillo redondo resalte de 26 mm clipado</p>

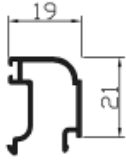

Ref **124553**
Junquillo redondo resalte de 19 mm clipado

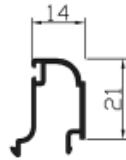

Ref **124554**
Junquillo redondo resalte de 14 mm clipado







Ref **124555**
Junquillo redondo resalte de 14 mm con grapa

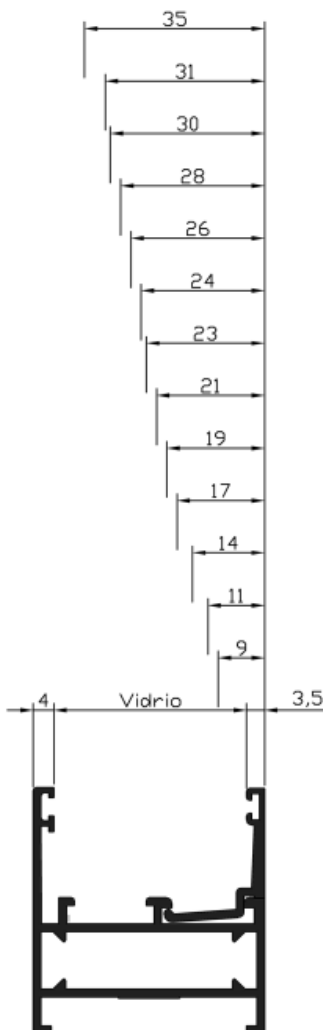

Ref **124556**
Junquillo recto de 11 mm



Ref 20709				
Ref 21783				
	Ref 21678	Ref 21568		
Ref 20710				
			Ref 124551	Ref 124552
Ref 21782				
	Ref 21677	Ref 21567		
Ref 20711				
	Ref 24558	Ref 21789	Ref 124550	Ref 124553
Ref 21786	Ref 21676	Ref 21566		
Ref 20712	Ref 21780	Ref 21787	Ref 124555	Ref 124554
Ref 124556	Ref 21675	Ref 21565		
Ref 21551				
Ref 24557				
				

Ejemplo de tabla de aplicación de junquillos para acristalamiento.
Esquema representado serie GREEN.

Perfiles extrusionados en aleación 6060 (EN 573-3)
Estado de suministro T-5 (EN 755-2)
Tolerancias de dimensiones y espesores según norma EN 755-9

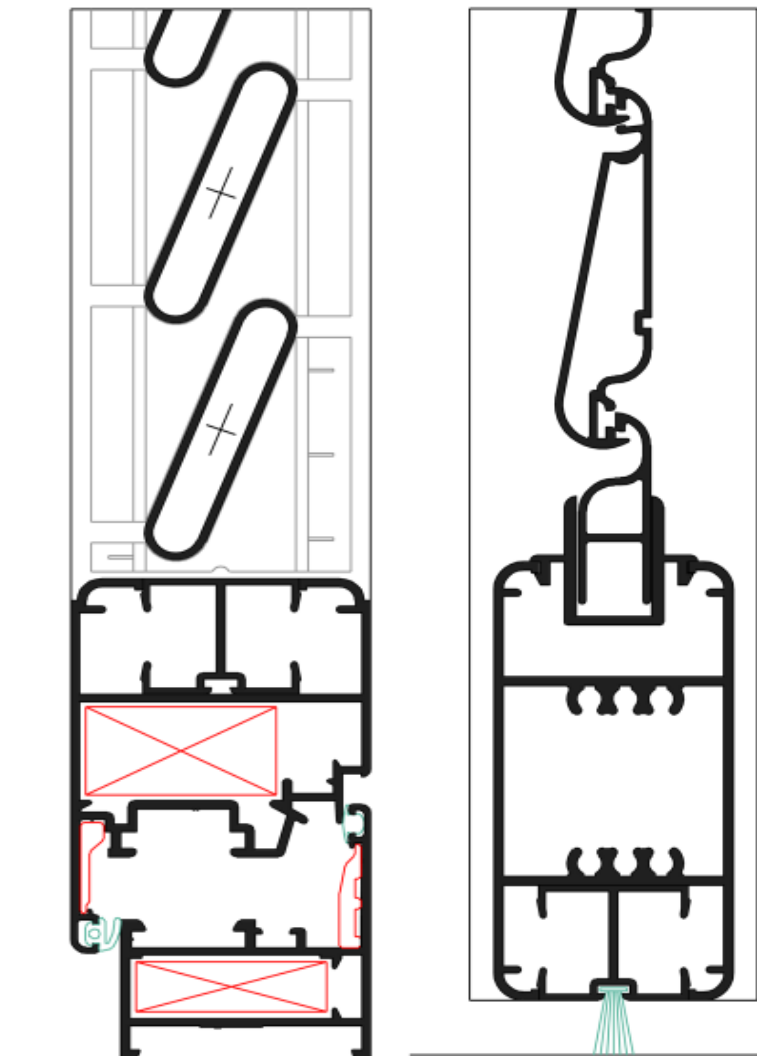



Ref. **503-9593**
Lama fija

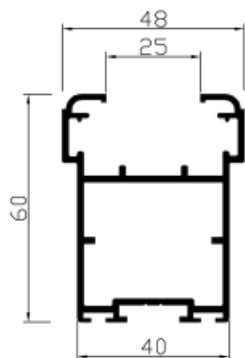

Ref. **2517**
Hoja corredera / plegable

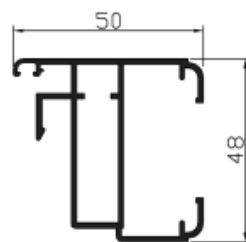

Ref. **2518**
Acoplamiento fijos



Ref. **12506**
Lama móvil

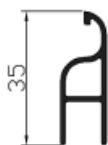

Ref. **12507**
Distanciador



Ref. **12508**
Distanciador

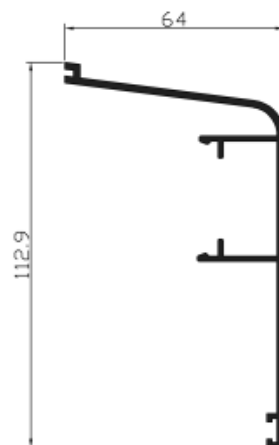

Ref. **16073**
Tapeta guía superior corredera

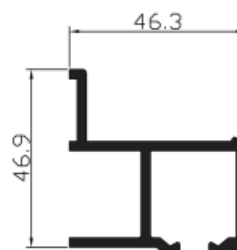

Ref. **16074**
Guía superior corredera

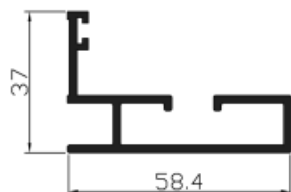

Ref. **16075**
Guía inferior corredera



Ref. **16077**
Tapeta hoja corredera

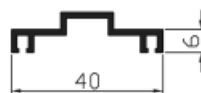

Ref. **19632**
Remate hoja corredera / plegable

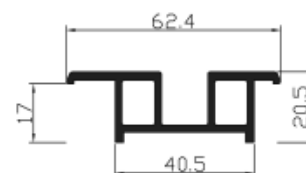

Ref. **19634**
Guía inferior embutida plegable

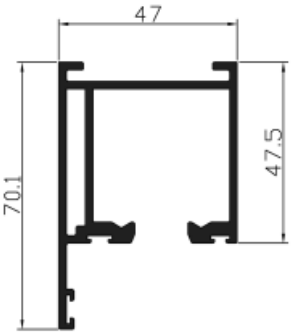
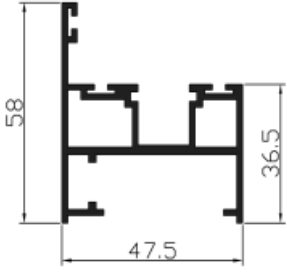
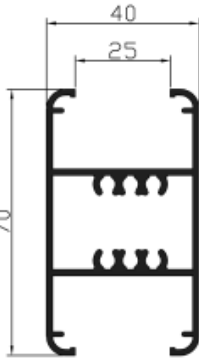
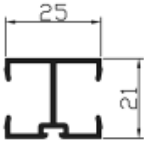
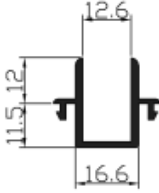
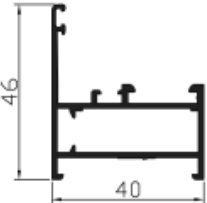
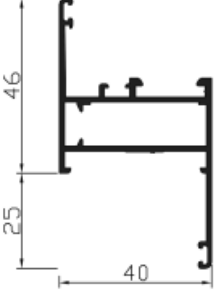
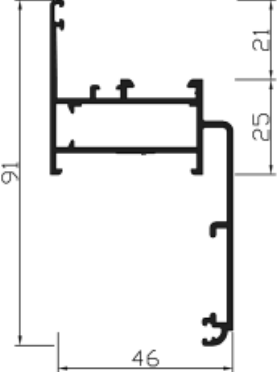
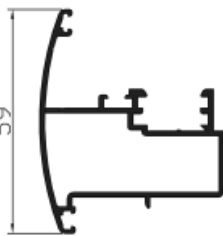
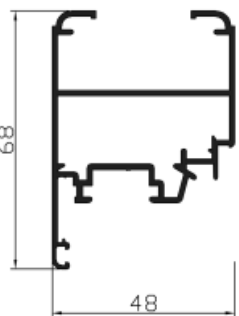
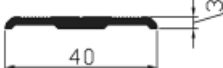
 <p>Ref. 19637 Tapeta solape</p>	 <p>Ref. 19643 Guia superior plegable</p>	 <p>Ref. 20373 Marco lateral / inferior plegable</p>	 <p>Ref. 24406 Travesaño horizontal</p>
 <p>Ref. 24457 Acoplamiento travesaño / hoja</p>	 <p>Ref. 24459 Perfil para distanciadores</p>	 <p>Ref. 27000 Marco ventana</p>	 <p>Ref. 27001 Marco con tapajuntas</p>
 <p>Ref. 27006 Marco coplanario con tapajuntas * Consultar stock</p>	 <p>Ref. 27031 Acoplamiento dos hojas</p>	 <p>Ref. 27033 Hoja practicable</p>	 <p>Ref. 27994 Remate suelo</p>

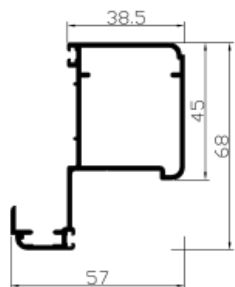

Ref. **21704**
Hoja portalama



Ref. **21707**
Refuerzo intermedio



Ref. **21708**
Apoyo refuerzo

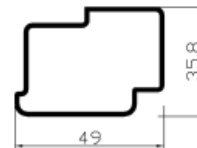

Ref. **21751**
Acoplamiento dos hojas

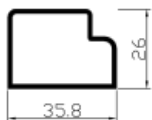

Ref. **21752**
Remate inferior



Ref. **21757**
Lama porticón

Secciones Euro mallorquina oscura

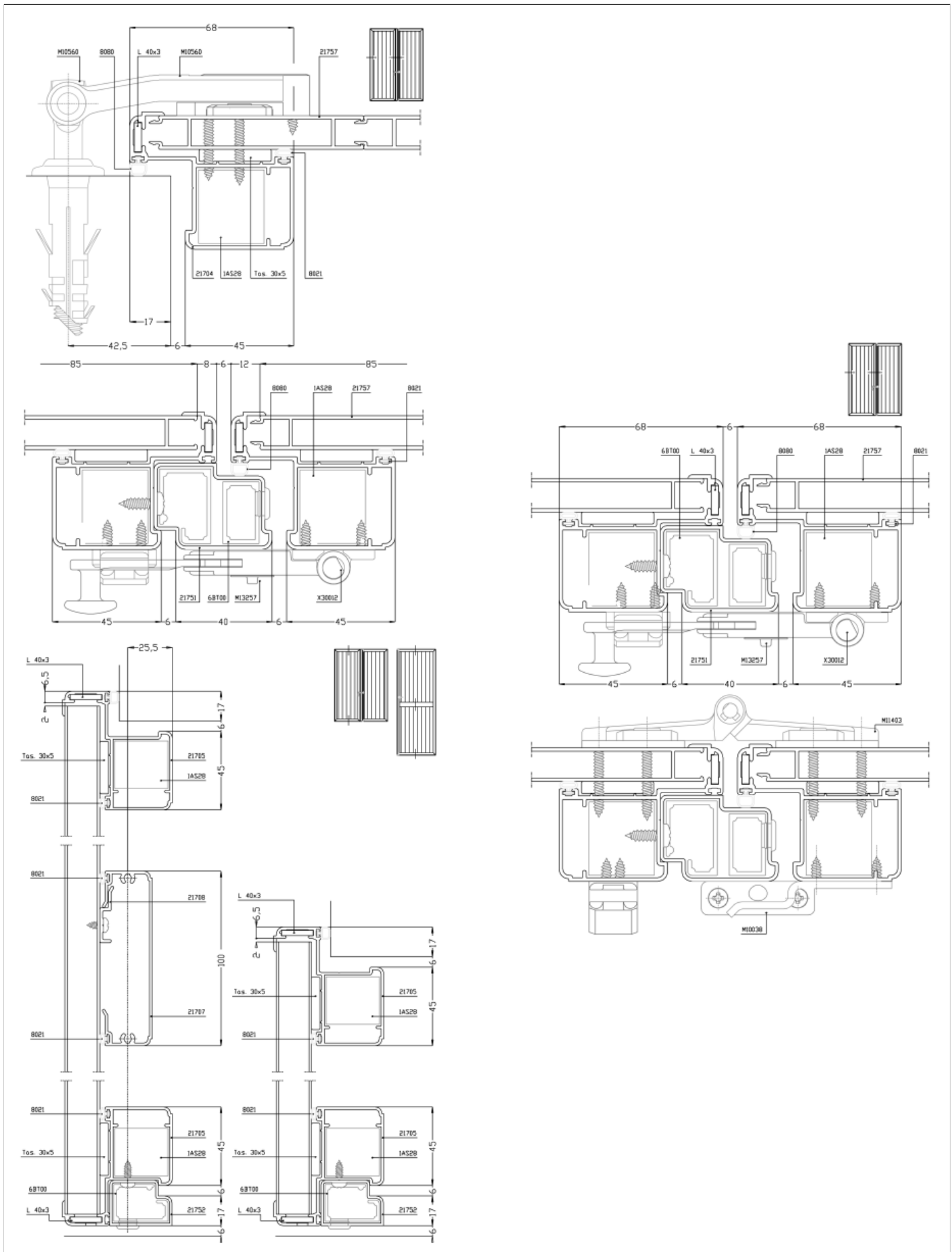

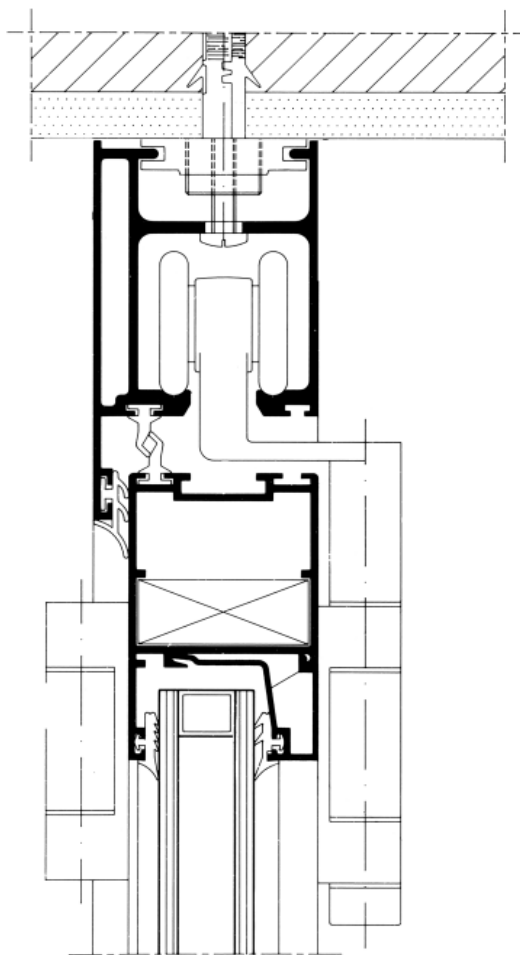

Perfiles extrusionados en aleación 6063 (UNE - 38337)
Estado de suministro T-5
Tolerancias de dimensiones y espesores según norma UNE 38066

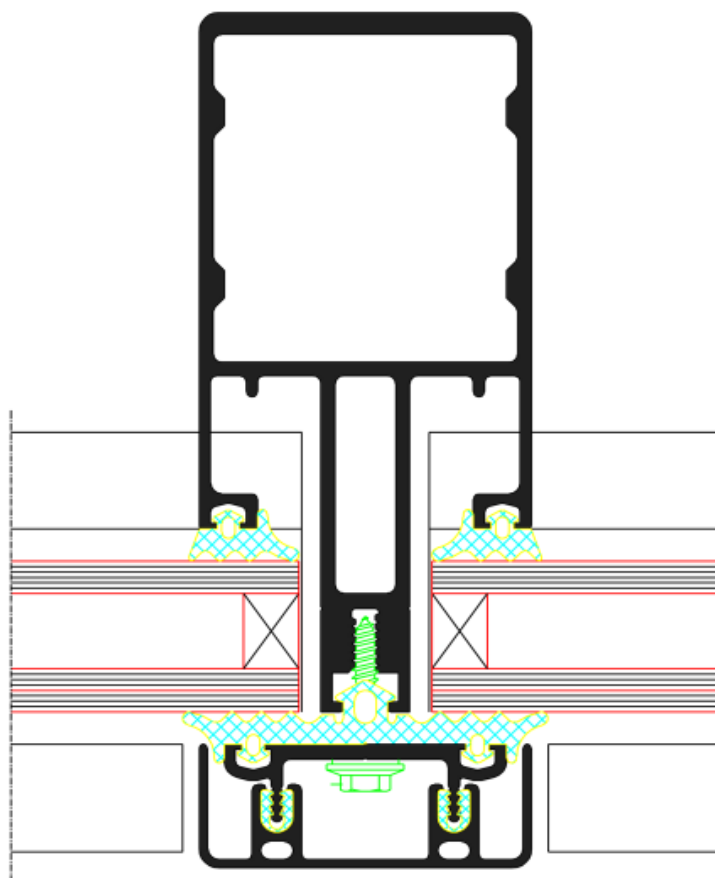

<p>Ref 19632 Remate inferior hoja</p>	<p>Ref 19634 Guia inferior embutida</p>	<p>Ref 19635 Hoja</p>	<p>Ref 19636 Travesaño</p>
<p>Ref 19637 Tapeta solape</p>	<p>Ref 19638 Junquillo recto de 10,5 mm</p>	<p>Ref 19639 Junquillo recto de 20,5 mm</p>	<p>Ref 19643 Guia superior</p>
<p>Ref 20373 Marco lateral / inferior</p>	<p>Ref 27317 Junquillo recto de 14 mm *Consultar stock</p>		

Perfiles extrusionados en aleación 6060 (EN 573-3)
Estado de suministro T-5 (EN 755-2)
Tolerancias de dimensiones y espesores según norma EN 755-9

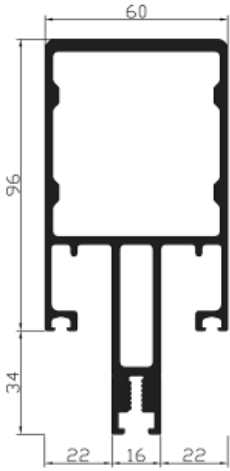
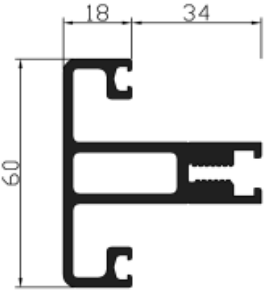
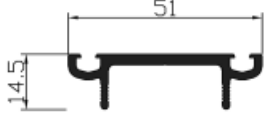
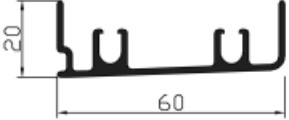
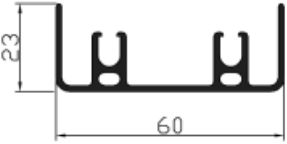

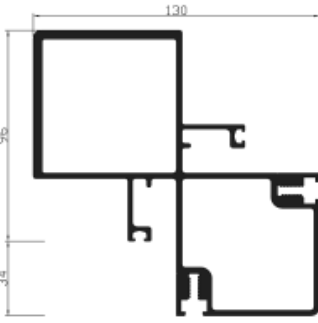
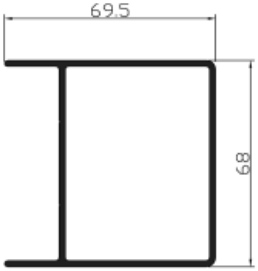
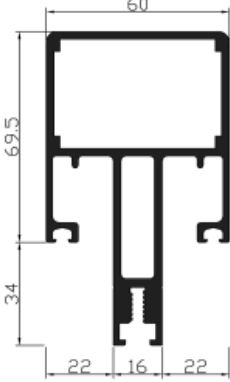
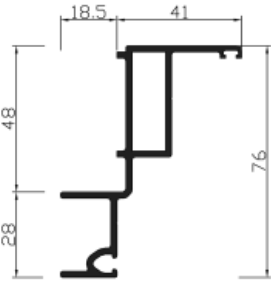
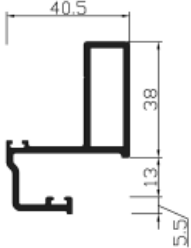
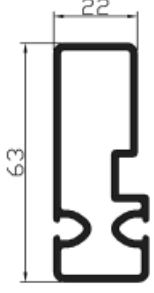
 <p>Ref. 21106 Montante</p>	 <p>Ref. 21107 Travesaño</p>	 <p>Ref. 21110 Tapeta presión vidrio</p>	 <p>Ref. 21111 Tapeta horizontal</p>
 <p>Ref. 21112 Tapeta vertical</p>	 <p>Ref. 21115 Reductor vidrio</p>	 <p>Ref. 21124 Esquinero</p>	 <p>Ref. 21128 Refuerzo travesaño</p>
 <p>Ref. 21130 Montante</p>	 <p>Ref. 21136 Marco abertura externa</p>	 <p>Ref. 21137 Hoja estructural</p>	 <p>Ref. 21139 Remate pared</p>

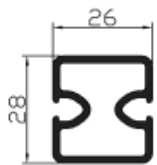

Ref **21143**
Suplemento remate

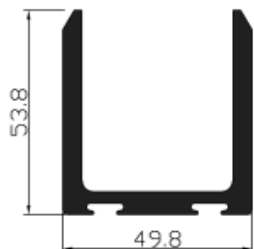

Ref **21231**
Refuerzo unión montantes



Ref **21234**
Refuerzo unión montantes

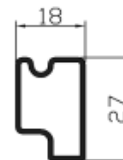

Ref **21235**
Canalón para drenaje en union de montantes

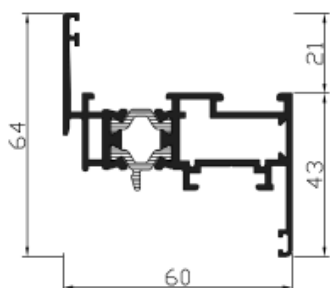



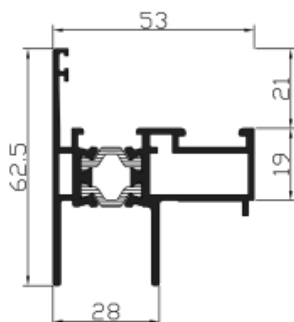







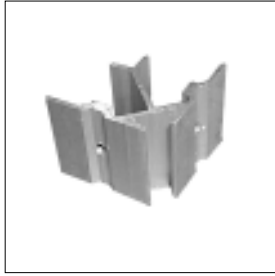

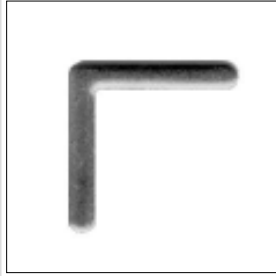

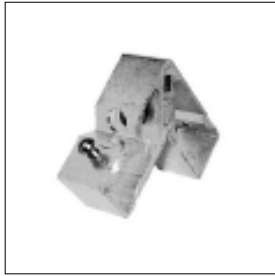

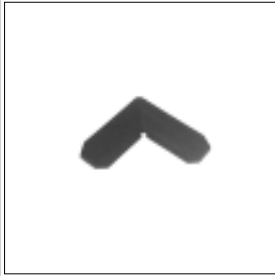
Ref **22010**
Hoja ventana

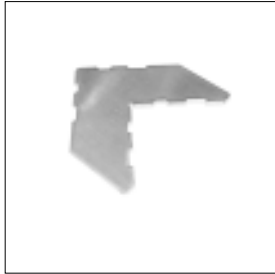



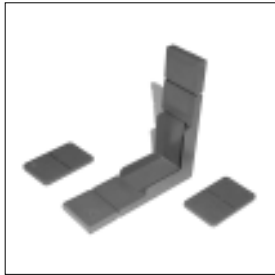















Ref **22310**
Marco ventana











Accesorios

<u>Producto</u>	<u>Pág</u>
Escuadras	82
Bisagras	85
Frenos y fresas	86
Cremonas y herrajes oscilo	87
Decor-Stil	89
Uniones	90
Tapas estanqueidad y juntas	91
Cerraduras, cierres y tiradores	93
Herrajes Euro Mallorca	97
Accesorios varios	97
Ruedas y cortavientos	98
Accesorios barandillas	99
Accesorios puertas jardin HORIZONTAL	105
Herrajes Oscura	107
Herrajes Wood	109
Accesorios Euro Runner 250tt	115

				
Serie Lisa Ref: 0903714 Escuadra de tornillos 37 x 14	Serie Lisa Ref: 0903731 Escuadra de tornillos 37 x 31	Euro 40 Green Wood Ref: IAS02 Escuadra de tetones 18 X 32,5	Series practicables Abithal Ref: IAS07 Escuadra de alineamiento Inox	Euro-keeper 45 Ref: IAS28 Escuadra de tetones 31,8 x 28,8
				
Euro 40 Green Wood Ref: IAS36 Escuadra de tetones 37 x 14	Euro 40 Green Wood Ref: IAS56 Escuadra de tornillos 36 x 32,5	Euro-keeper 45 Ref: IAS87 Escuadra de alineamiento con excéntrica de presión marco	Keeper 61-68 Ref: IAS88 Escuadra de alineamiento con excéntrica de presión marco/hoja	Green Keeper 61-68 Ref: IAS90 Escuadra de alineamiento en nylon para hoja
				
Keeper 61-68 Ref: ZAS83 Escuadra de alineamiento	Keeper 61-68 Ref: ZAS37 Escuadra de alineamiento	Euro 40 Green Euro-keeper 45 Keeper 61-68 Ref: IAS96 Escuadra de alineamiento en nylon para marco	Euro 40 Green Euro-keeper 45 Ref: IAS97 Escuadra de alineamiento en nylon para hoja	1AE02 Green 1AE03 Varias carpinterías 4AE01 Runner Ref: Expansores Expansores de fijación
				
Euro 40 Green Euro-keeper 45 Keeper 61-68 Ref: IAV01 Escuadra calzo vidrio con expansor	Euro 40 Green Euro-keeper 45 Keeper 61-68 Ref: IAV03 Escuadra calzo vidrio. El expansor es el 1AE03	Euro-keeper 45 Keeper 61-68 Elevable Runner 250tt Ref: IBS01 Escuadra de tetones 11 x 26	Green Euro-keeper 45 Keeper 61-68 Elevable Runner 250tt Ref: IBS02 Escuadra de tetones 18 x 26	Euro-keeper 45 Keeper 61-68 Ref: IBS03 Escuadra de tetones 36 x 26

Escuadras

				
Runner 61-90 Ref. 1BS04 Escuadra de tetones 11 x 41	Runner 61-90 Runner 61-90 tt Ref. 1BS05 Escuadra de tetones 11 x 21	Runner 61-90 tt Ref. 1BS08 Escuadra de tetones 11 x 18	Euro-keeper 45 Keeper 61-68 Ref. 1BS31 Escuadra a grados variables	Green Euro-keeper 45 Keeper 61-68 Ref. 1BS65 Escuadra a grados variables
				
Keeper 61-68 Ref. 2AS55 Escuadra de tornillos 36 x 26	Euro-keeper 61-68 Keeper 61-68 Ref. 2AS81 Escuadra de alineamiento 3,7 x 11	Keeper 61-68 Ref. 2AS82 Escuadra de alineamiento 3,7 x 18	Euro-keeper 45 Ref. 2AS84 Escuadra de alineamiento para marco	Euro-keeper 45 Ref. 2AS86 Escuadra de alineamiento
				
Euro-keeper 45 Ref. 2AS87 Escuadra de alineamiento	Runner 61-90 tt Ref. 4AS01 Escuadra de alineamiento 3 x 11	Runner 61-90 tt Ref. 4AS02 Escuadra de alineamiento 3 x 18	Runner 61-90 tt Ref. 4MS65 Escuadra de plástico	Forro 24563 Ref. 6000005 Escuadra de alineamiento 8997/40
				
Cajón registro persiana 24444 Ref. 308 Escuadra para perfil registro de persiana	Euro mallorquina Plegable Garden Ref. 04A21 Escuadra de tetones 04A21	Samblex 40i Ref. 04A22 Escuadra de tetones 04A22	Forro 65020 Ref. 120 Escuadra de alineamiento 120	Corredera P70CO Ref. 243 Escuadra de tetones 243

				
<p>Forros</p> <p>Ref. 902 Escuadra de alineamiento 902</p>	<p>Forros</p> <p>Ref. 903 Escuadra de alineamiento 903</p>	<p>P70CO</p> <p>Ref. 242 Escuadra de tetones 242</p>	<p>Samblex 40i</p> <p>Ref. 15A62 Escuadra de alineamiento 15A62</p>	<p>Euro 40 Green Runner 61-90 tres carriles</p> <p>Ref. 9630 Escuadra de tetones 9630</p>
				
<p>Euro 40 Green</p> <p>Ref. 9632 Escuadra a grados variables 9632</p>	<p>Keeper 45</p> <p>Ref. 9633 Escuadra a grados variables 9633</p>	<p>Euro 40 Green</p> <p>Ref. 9652 Escuadra de tetones 36x32</p>	<p>P65CO</p> <p>Ref. 231 Escuadra tetones hoja</p>	<p>P65CO</p> <p>Ref. 241N Escuadra tetones marco</p>

Bisagras

				
Practicable tradicional	Practicable tradicional	Practicable tradicional	Practicable tradicional	Euro mallorquina Plegable Garden
Ref. 9085 Bisagra 9085 para freno	Ref. 9086 Bisagra 9086 derecha Bisagra 9086 izquierda	Ref. 9087 Bisagra vaiven 9087	Ref. 9088 Bisagra vaiven 9088	Ref. 30B05 Bisagra reversible 30B05
				
Euro mallorquina Plegable Garden	Samblex 40i	Samblex 40i	Series cámara europea	Series cámara europea
Ref. 30B06 Bisagra reversible 30B06	Ref. 40B05T-07T Bisagra reversible, 05 Lac. blanco 07 Lacado negro	Ref. 40T91 Bisagra 2ª Hoja 40T91	Ref. 1GC02 Bisagra reversible	Ref. 1GC02D-I Bisagra montada der-izq
				
Series cámara europea	Green Keeper 61-68	Green Keeper 61-68	Green Keeper 61-68	Green Keeper 61-68
Ref. 1GC1362 Bisagra 3ª hoja reversible	Ref. 1GC35 Bisagra tenax dos palas desiguales para acople plano	Ref. 1GC45 Bisagra tenax tres palas desiguales para acople plano	Ref. 1GC55 Bisagra tenax dos palas iguales para acople plano	Ref. 1GC70 Bisagra tenax dos alas para acople plano
				
Series cámara europea	Series cámara europea	Series cámara europea	Series cámara europea	Series cámara europea
Ref. 1GC75 Bisagra inferior freno	Ref. 1GC85 Bisagra BRIDGE 1GC85	Ref. 1GC95 Bisagra BRIDGE 3ª hoja	Ref. 1GC99 Bisagra tenax dos palas desiguales con espesor	Ref. 1GC141 Conjunto bisagra hoja pasiva oscilo batiente





				
<p>Series cámara europea</p> <p>Ref. 3232 Taco suplemento bisagra para freno inferior</p>	<p>Euro mallorquina</p> <p>Ref. B4H Bisagra 4ª hoja con eje distanciado</p>	<p>Green Euro-Keeper 45</p> <p>Ref. 10C29H-V Juego de pivotes H Horizontal V Vertical</p>	<p>Series cámara europea</p> <p>Ref. 3224 Distanciador interno en perfil para bisagras tenax</p>	<p>Series cámara europea</p> <p>Ref. 90AE01 Bisagra reforzada dos palas</p>

Frenos y fresas



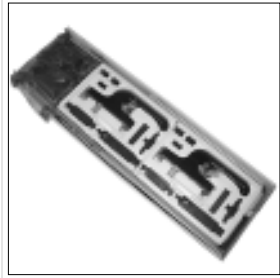
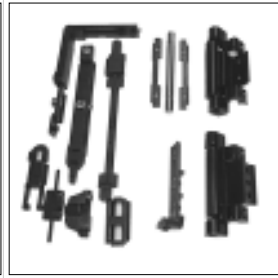
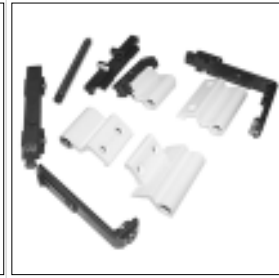
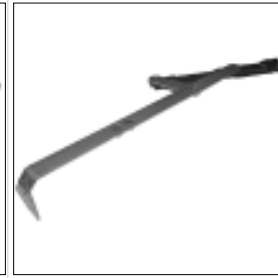
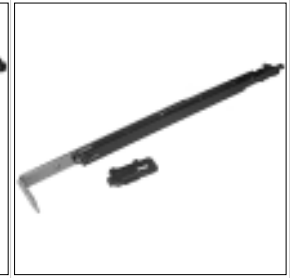

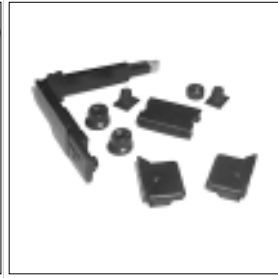
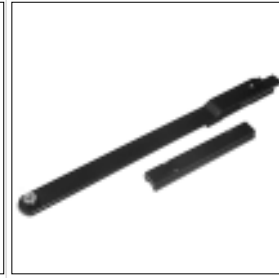
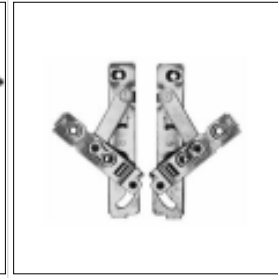
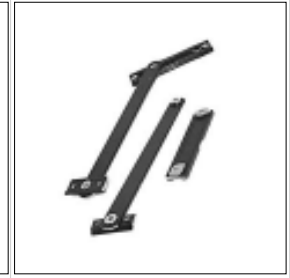







				
<p>Universal</p> <p>Ref. 7300 Freno MAB 7300</p>	<p>Green</p> <p>Ref. 9FR01 Fresas travesaño Green-Keeper</p>	<p>Green</p> <p>Ref. 9FR25 Fresas marco Euro-Keeper</p>	<p>Green</p> <p>Ref. 9FR26 Fresas hoja Euro-Keeper</p>	<p>Euro-keeper 45</p> <p>Ref. 9FR27 Fresas travesaño vidrio directo Euro-Keeper</p>
				
<p>Keeper 61-68</p> <p>Ref. 9FR30 Fresas travesaño marco</p>	<p>Euro 40</p> <p>Ref. 9FR40 Fresas travesaño Euro 40</p>	<p>Wood</p> <p>Ref. 9FR45 Fresas travesaño hoja Wood</p>	<p>Samblex 40i</p> <p>Ref. 40Z01 Fresa travesaño</p>	<p>Fresas</p> <p>Ref. 9901 Eje porta fresas</p>

Cremonas

<p>Practicable tradicional</p> <p>Ref. 2080 Manubrio 2080</p>	<p>Series cámara europea</p> <p>Ref. 1GR90 Base cremona practicable * Consultar</p>	<p>Series cámara europea</p> <p>Ref. 1GR91 Maneta desmontable * Consultar</p>	<p>Series cámara europea</p> <p>Ref. 1GR89 Base cremona oscilo batiente * Consultar</p>	<p>Plegable Garden</p> <p>Ref. 13M30 Manubrio 13M30</p>
<p>Plegable Garden</p> <p>Ref. 8999Y79 Cremona con llave</p>	<p>Series cámara europea</p> <p>Ref. 30M05 Maneta 30M05 de cerradura</p>	<p>Series cámara europea Samblex 40i</p> <p>Ref. 1GM18 Cremona pivotante</p>	<p>Series cámara europea Samblex 40i</p> <p>Ref. 9800001 Maneta Slitta</p>	<p>Plegable Garden</p> <p>Ref. 13C43 Cremona oscilobatiante con llave * Consultar</p>
<p>Series cámara europea</p> <p>Ref. 1GM1142 Cremona practicable Máxima Disponibile en blanco y en negro</p>	<p>Series cámara europea</p> <p>Ref. 1GR1144 Cremona oscilobatiante Maxima Disponibile en blanco y en negro</p>	<p>Series cámara europea</p> <p>Ref. 1GM14 Cremona practicable Globo Dispon. en oro, blanco y negro</p>	<p>Series cámara europea</p> <p>Ref. 1GR27 Cremona oscilobatiante Globo Dispon. en oro, blanco y negro</p>	<p>P7OCO</p> <p>Ref. 1GM1651 Cremona para cierre multipunto en correderas (oro, blanco y negro)</p>
<p>P7OCO</p> <p>Ref. 1GM3050 Cremona para cierre multipunto en correderas</p>				





				
<p>Samblex 40i</p> <p>Ref: 40U01T Herraje oscilo batiente</p>	<p>Series cámara europea</p> <p>Ref: 1GR02 Herraje oscilo batiente Acab. oro, plata, negro, blanco</p>	<p>Series cámara europea</p> <p>Ref: 1GR05 Herraje oscilo batiente coplanaria Acabado en blanco y negro</p>	<p>Series cámara europea</p> <p>Ref: 8917011 Compas suplementario</p>	<p>Series cámara europea</p> <p>Ref: 1GR17 Compas oscilo batiente tipo 1</p>
				
<p>Series cámara europea</p> <p>Ref: 1GR16 Compas oscilo batiente tipo 2</p>	<p>Series cámara europea</p> <p>Ref: 1GR1843 Suplemento vertical / horizontal 1GR13</p>	<p>Series cámara europea</p> <p>Ref: 1GR1846 Compas suplementario 1GR15</p>	<p>Series cámara europea</p> <p>Ref: 1GD10 Compas basculante Inox</p>	<p>Series cámara europea</p> <p>Ref: 1GD11 Compas basculante</p>
 <p>Samblex 40i</p> <p>Ref: 40B21 Compas basculante</p>				

Decor-Stil Barandillas Ref. I0282 Barrote torneado simétrico L=835 mm.	Decor-Stil Ref. R1 Reja decorativa 80 x 320 mm	Decor-Stil Ref. R2 Reja decorativa 80 x 700 mm.	Decor-Stil Ref. R3 Reja decorativa 80 x 1100 mm	Decor-Stil Ref. R7 Reja decorativa 75 x 200 mm
Decor-Stil Ref. R8 Reja decorativa 90 x 250 mm	Decor-Stil Ref. R9 Reja decorativa 90 x 500 mm	Decor-Stil Ref. R10 Reja decorativa 65 x 600 mm	Decor-Stil Ref. A504 Florón	Decor-Stil Ref. A507 Florón
Decor-Stil Ref. A509 Brida soporte barrote 30x20	Decor-Stil Ref. A515 Tuerca unión rejas	Decor-Stil Ref. A520/60 Varilla roscada unión rejas	Decor-Stil Ref. A530 Tubo redondo 12,5 X 3 mm Acabado oro	Decor-Stil Ref. A540 Terminal
Decor-Stil Ref. A541 Terminal	Decor-Stil Ref. C201 Unión cruceta celosías	Decor-Stil Ref. C202 Unión cruceta celosías	Decor-Stil Ref. C203 Unión cruceta celosías	Decor-Stil Ref. R634 Tubo de rejas en porticones

				
<p>Serie Lisa</p> <p>Ref: 0900030 Unión travesaño 40x20</p>	<p>Serie Lisa</p> <p>Ref: 0900031 Unión travesaño 40x40</p>	<p>Samblex 40i</p> <p>Ref: 40E01 Unión travesaño 40E01</p>	<p>Green</p> <p>Ref: 1AG57 Unión travesaño 1AG57</p>	<p>Euro 40 Green</p> <p>Ref: 1AG58 Unión travesaño 1AG58</p>
				
<p>Green Euro-keeper 45</p> <p>Ref: 1AG91 Unión travesaño 1AG91</p>	<p>Euro 40 Euro-keeper 45</p> <p>Ref: 1MG60 Unión travesaño 1MG60</p>	<p>Green Keeper 61-68</p> <p>Ref: 2AG42 Unión travesaño 2AG42</p>	<p>Keeper 61-68</p> <p>Ref: 2AG43 Unión travesaño 2AG43</p>	<p>Wood</p> <p>Ref: 7AG01 Unión travesaño 7AG01</p>
				
<p>Divisiones oficina</p> <p>Ref: 10470 Unión mampara division oficinas</p>	<p>Serie Garden</p> <p>Ref: 04E21 Unión para marco 20373</p>	<p>Serie Garden</p> <p>Ref: 30E21 Unión complemento 04E21 para marco 20373</p>		

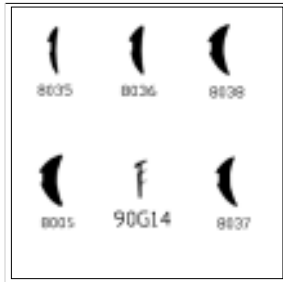
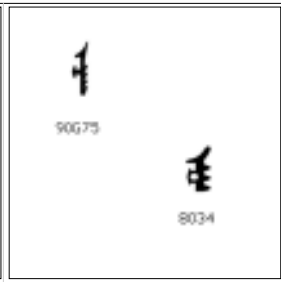
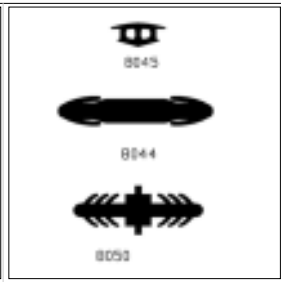
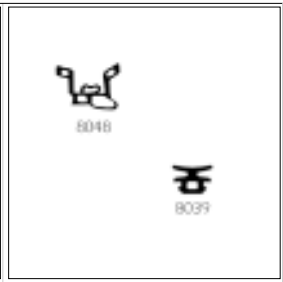
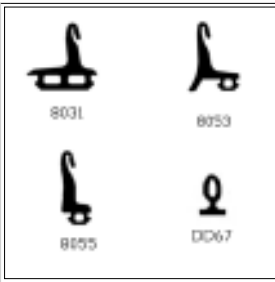
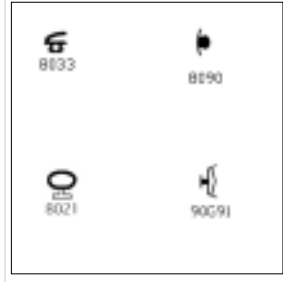
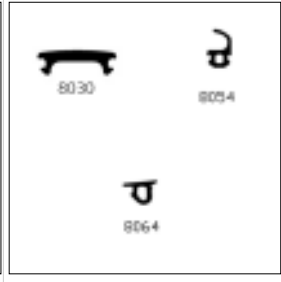
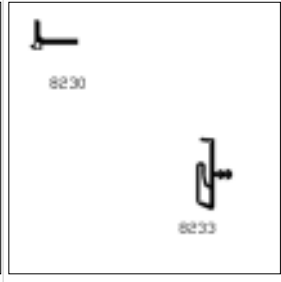
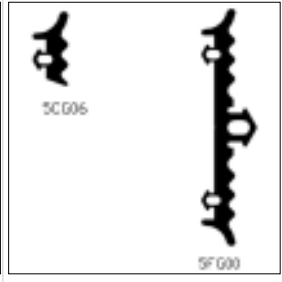
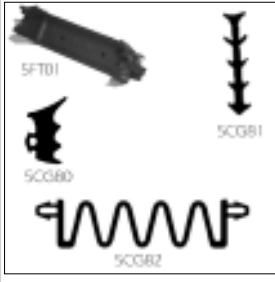
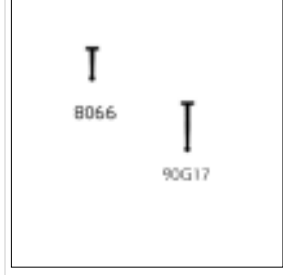
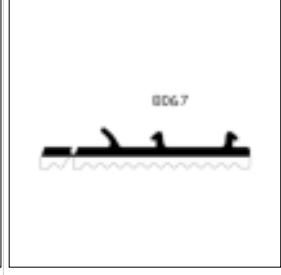

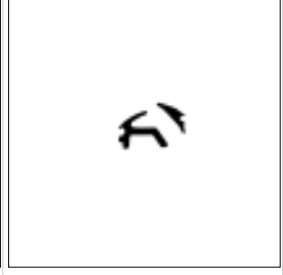
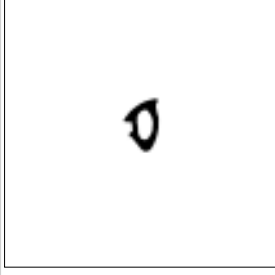
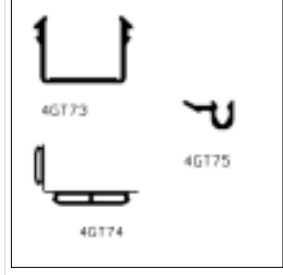
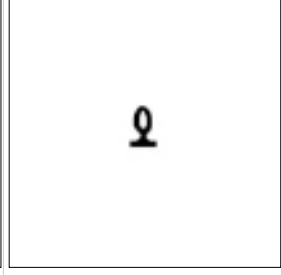

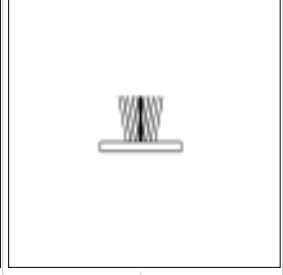
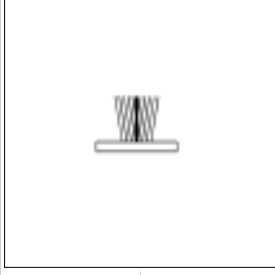













Tapas estanqueidad y grapas

Samblex 40i Ref. 40D07 Tapas estanqueidad 13J02	Samblex 40i Ref. 40D08 Tapa T - Z 40D08	Samblex 40i Ref. 40T95 Tapa estanqueidad 40T95	Plegable Garden Ref. 1AT01 Tapa estanqueidad 1AT01	Green Ref. 1AT10 Tapa estanqueidad 1AT10 perfil 21633 apertura exterior
Green Ref. 1AT11 Tapa estanqueidad 1AT11 perfil 21633 apertura interior	Keeper 61-68 Ref. 2AT11 Tapa estanqueidad 2AT11	Keeper 61-68 Ref. 2AT15 Tapa estanqueidad 2AT15	Euro 40 Euro-keeper 45 Ref. 2AT53 Tapa estanqueidad 2AT53	Keeper 61-68 Ref. 2AT67 Tapa estanqueidad 2AT67
Green Ref. 3AT01 Tapa estanqueidad 3AT01	Euro 40 Green Euro-keeper 45 Keeper 61-68 Ref. 3AT32 Tapa estanqueidad vierteaguas	Runner Ref. 4MT13 Estanqueidad adhesiva marco corte recto	Wood Ref. 7AT01 Tapa estanqueidad 7AT01	Series cámara europea Ref. 1AZ21 Inglete zamac junquillos canto redondo
Series cámara europea Ref. 1AB48 Grapa junquillo curvo	Samblex 40i Ref. 40D01 Grapa junquillo curvo	Todas las practicable Ref. 1GT90 Tapeta salida agua	Todas las series Ref. 15D01 Tapeta rígida salida agua	Euro 40 Ref. 1AT19 Tapa para franja 24406

				
<p>8005 6mm 8038 5mm 8035 2mm 90G14 2mm 8036 3mm 90G59 7mm 8037 4mm</p> <p>Ref Juntas de cuña Juntas de acristalar interior - exteriormente de cuña</p>	<p>8034 3mm 90G75 3mm</p> <p>Ref Juntas externas Juntas de acristalar exteriormente guiadas</p>	<p>8044 8045 8050</p> <p>Ref Juntas dilatación Juntas de dilatación de montantes</p>	<p>8039 Green 8048 Euro-keeper 45</p> <p>Ref Juntas pivotantes Juntas de estanqueidad para acoplamiento pivotantes</p>	<p>8031 Green / Keeper 61-68 8053 Euro-Keeper 45 8055 Euro 40 DD67 P7OCO</p> <p>Ref Juntas central Juntas EPDM estanqueidad central</p>
				
<p>8021 8033 8090 Abertura exterior 90G91 Samblex 40i</p> <p>Ref Juntas solape Juntas de solape entre marco y hoja</p>	<p>8030 Cámara europea 8054 Euro-Keeper 45 8064 Keeper 61-68</p> <p>Ref Juntas condensación Juntas de condensación en marcos</p>	<p>8230 8233</p> <p>Ref Juntas Wood Juntas de la carpintería Abithal Wood</p>	<p>5FG00 5CG06</p> <p>Ref Juntas Wall Juntas de acristalamiento en muro cortina</p>	<p>5CG80 5CG81 5CG82 5FT01</p> <p>Ref Juntas Wall Juntas de estanqueidad en muro cortina</p>
				
<p>Gomas</p> <p>Ref 8066 Remate inferior zócalos</p>	<p>Euro-Keeper 45 Keeper 61-68</p> <p>Ref 8067 Junta de aislamiento</p>	<p>90G97 90G98 90G99</p> <p>Ref Plegable Garden Juntas de estanqueidad en plegable Garden</p>	<p>División</p> <p>Ref 0923468 Goma acristalamiento</p>	<p>Gomas</p> <p>Ref R10D4 Goma de registro persiana</p>
				
<p>4GT73 4GT74 4GT75</p> <p>Ref Juntas Runner Gomas de estanqueidad y acristalamiento</p>	<p>980004</p> <p>Ref Juntas mallorquina Gomas de estanqueidad en lamas mallorquina</p>	<p>8032 Green / Keeper 61-68 8056 Euro-Keeper 45 8057 Euro 40</p> <p>Ref Angulos vulcanizados Angulos EPDM sellados e ingletados a 90°</p>	<p>7 x 6,25 S-65i 6 x 4,8 S-62 7 x 5 S-72 6 x 5,3 S-62 7 x 5,5 P7OCO 7 x 5,5 Runner 7 x 8 P7OCO 6 x 6,5 S-72</p> <p>Ref Cepillos Cepillos con lámina de plástico</p>	<p>5 x 6 Guia p. 7 x 8 5 x 8 Guia p. 6 x 5 Vitrina 14 x 12 S. lisa 5 x 11 Vaiven 23 x 10 Cortav.</p> <p>Ref Cepillos Cepillos sin lámina de plástico</p>









Cerraduras

Series cámara europea Ref. 13S28 Cerradura sup / inf 3 puntos	Series cámara europea Ref. 13S29 Cerradura vertical	Series cámara europea Ref. 13S30 Cerradura	Series cámara europea Ref. 13S31 Cerradura central 3 puntos	Series cámara europea Ref. 13S34 Cerradura
Series cámara europea Ref. 13S52 Cerradura	Series cámara europea Ref. 13S55 Cerradura	Euro mallorquina (2517) Plegable Garden Ref. 30S01 Cerradura para llave cruz (sin bombín)	Euro mallorquina (2517) Plegable Garden Ref. 30S02 Cerradura para llave de bombín	Series cámara europea Ref. 80S13 Cerradura golpe y llave
Series cámara europea Ref. 80S14 Bombín de 54 mm centrado 22 + 10 + 22	Seroes cámara europea Ref. 80S15 Bombín de 66 mm descentrado 22 + 10 + 34	Universal Ref. 80S16 Bombín de 60 mm descentrado 22 + 10 + 28	Universal Ref. 80S20 Bombín de 60 mm descentrado 22 + 10 + 28	Universal Ref. 80S21 Bombín de 54 mm centrado 22 + 10 + 22
Universal Ref. 80S22 Bombín de 66 mm 22 + 10 + 34	Series cámara europea Ref. 80S36 Cerradura	Series cámara europea Ref. 80S41-42 Cerradura eléctrica	Samblex 40i Ref. 80S24 Cerradura golpe y llave	Samblex 40i Ref. 80S25 Cerradura rodillo y llave

				
Guia vitrina	Guia vitrina	Series cámara europea	Series cámara europea	Series cámara europea
Ref. P30 Cierre de vitrina P30	Ref. AGA155 Cierre de vitrina AGA 155	Ref. IGM26 Kit abertura exterior	Ref. IGM35 Piezas ensamble pletina cremona	Ref. IGM36 Terminal pletina cremona
				
Series cámara europea	Series cámara europea	Series cámara europea	Series cámara europea	Series cámara europea
Ref. IGM19 Encuentro terminal cremona	Ref. IGM17 Dedal metálico	Ref. IGD01 Cierre golpe basculante	Ref. IGD06 Cierre golpe basculante	Ref. IGM33 Cierre superior / inferior
				
Series cámara europea	Seroes cámara europea	Euro mallorquina Plegable Garden	Euro mallorquina Plegable Garden	Euro mallorquina Plegable Garden
Ref. IGD30 Bulón excéntrico	Ref. IGD43 Entuerto 3er punto de cierre	Ref. 30D03 Piezas conexión pletina/barillas con cremona	Ref. 30D10 Terminal barilla	Ref. 30D15 Cierre de barillas
				
Euro mallorquina Plegable Garden	Samblex 40i	Samblex 40i	Samblex 40i	
Ref. 30M16 Uñero tirador	Ref. 64D1L Piezas conexión pletina con cremona	Ref. 40D10 Kit de unión fijación cremona apertura externa	Ref. 40D020T Terminal pletina cremona	

Cierres y tiradores

Samblex 40i	Samblex 40i	Samblex 40i	Samblex 40i	Series cámara europea
Ref. 40D03 Encuentro doble con pletina cremona	Ref. 40D04 Encuentro para 3er punto de cierre	Ref. 40D05 Cierre suplementario	Ref. 40T96 Pasador hoja pasiva oscilobatiente	Ref. 13D12 Pasador puerta superpuesto
Series cámara europea	Series cámara europea	Samblex 40i	S-72 S-62 P65CO Runner	S-72 Samblex 65i S-62 P65CO Runner *todas con cierre alfa
Ref. 13D13 Pasador puerta guiado	Ref. 1GM31 Resbalón de apoyo hoja	Ref. 40D060T Pasador hoja pasiva	Ref. 9500010 Cierre alfa	Ref. 9500013 Tirador alfa
S-72 Samblex 65i S-62 P65CO Runner	S-62	Samblex 65i P65CO	Samblex 65i P65CO	Samblex 65i P65CO
Ref. 9500014 Cierre alfa interior - exterior	Ref. CM62 Cierre manual S-62	Ref. 11M26 Cierre embutido ventana	Ref. 11M27 Cierre embutido balconera	Ref. 11M28 Tirador
Runner	Runner	Runner	P70CO	S-72
Ref. 4MM04-05 Cierre embutido	Ref. 4MM61-62 Cierre tres puntos Opera	Ref. 4MM71-72 Cierre tres puntos Europa	Ref. 4MM65-66 Cierre multipunto 65 -> 1,80 mts 66 -> 1 mts	Ref. 950011 Kit gancho cierre alfa S72

				
<p>P70CO Runner</p> <p>Ref. 950012 Kit gancho cierre alfa P70CO y Runner</p>	<p>S-62</p> <p>Ref. 950016 Kit gancho cierre S-62</p>	<p>Runner</p> <p>Ref. 4MM10 Kit gancho cierre Medal Runner</p>	<p>Series cámara europea</p> <p>Ref. 13S08 Encuentro cerradura</p>	<p>Series cámara europea</p> <p>Ref. 13S09 Encuentro cerradura</p>
				
<p>Samblex 40i</p> <p>Ref. 40S01 Encuentro cerradura</p>	<p>Series cámara europea</p> <p>Ref. 3001 Kit cierre 1 hoja</p>	<p>Series cámara europea</p> <p>Ref. 3002 Kit cierre segunda hoja</p>	<p>Series cámara europea</p> <p>Ref. 3009 Kit cierre dos hojas</p>	

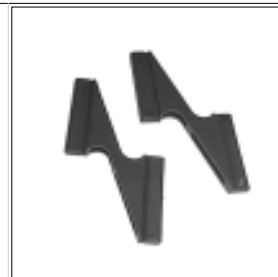

S662506 - 6 lamas	S662510 - 10 lamas	S662514 - 14 lamas	S662518 - 18 lamas	S662522 - 22 lamas	S662526 - 26 lamas	S662530 - 30 lamas
S662507 - 7 lamas	S662511 - 11 lamas	S662515 - 15 lamas	S662519 - 19 lamas	S662523 - 23 lamas	S662527 - 27 lamas	S662531 - 31 lamas
S662508 - 8 lamas	S662512 - 12 lamas	S662516 - 16 lamas	S662520 - 20 lamas	S662524 - 24 lamas	S662528 - 28 lamas	S662532 - 32 lamas
S662509 - 9 lamas	S662513 - 13 lamas	S662517 - 17 lamas	S662521 - 21 lamas	S662525 - 25 lamas	S662529 - 29 lamas	S662533 - 33 lamas

Mecanismos lama movil
Mecanismos de accionamiento de lama movil en Euro Mallorca

Ref. 6BS01
Pieza soporte lama fija



Euro Mallorca

Ref. 6BS10
Piezas inicio / final de lama fija



Euro Mallorca

Ref. Ropo24
Pomo accionamiento lamas



Euro Mallorca

Ref. 9800001
Tirador accionamiento lamas



Euro Mallorca

Ref. Soporte pared autom.
Soporte pared automático, para mallorquina practicable

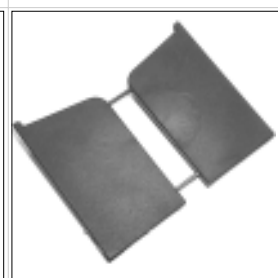

Euro Mallorca

Ref. 30D30
Tapetas perfil corredera corredera de peso suspendido



Euro Mallorca

Ref. PODES2041
Pomo desmontable

Accesorios varios



Green
Euro 40

Ref. 1RG01
Rodillo de guia / presión en junta central



Todas las series

Ref. 8900006
Tijeras guarnición

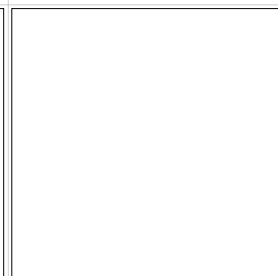

Fresolin 7 mm
Fresolin 8 mm

Ref. Fresolines
Fresolines de mecanizado para perfiles



perfiles lacados

Ref. 8500052
Limpiador para perfiles lacados



Maquinas de corte

Ref. 8500075
Bidón de aceite lubricante



perfiles lacados

Ref. 8500049
Stick reparador (varios colores)



perfiles y accesorios

Ref.
Spray de pintura (varios colores)























perfiles anodizados

Ref. 8500056
Limpiador para perfiles anodizados











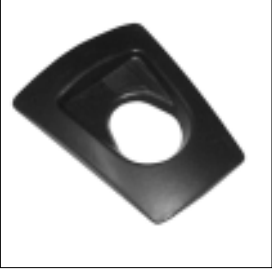







				
Guia vitrina Ref. R31 Rueda R31	Guia vitrina Ref. R45 Rueda R45	Samblex 65i Ref. I1R12 Kit 4 ruedas regulables	Samblex 65i Ref. I1R13 Kit 4 ruedas tandem	P70CO Ref. I1R70 Conjunto 4 ruedas regulables de aguja (100 kgs por hoja)
				
P70CO Ref. I1R71 Conjunto 4 ruedas regulables de aguja (100 kgs por hoja)	S-72 Ref. RRA72 Rueda regulable de agujas	S-62 Ref. RRT62 Rueda regulable de agujas	S-72 Ref. RRT72 Rueda regulable	S-72 Ref. RRT72M Rueda tandem
		 30R11	 30R10	
S-72 Ref. RT72R Rueda tandem	Euro matorquina Plegable Garden Ref. 30R01-02 Conjunto ruedas / bisagra para plegable	Euro matorquina Plegable Garden Ref. 30R10-11 30R10 Tope guia superior 30R11 Guia inferior	Euro matorquina Plegable Garden Ref. 30R12 Ruedas carril superior	Samblex 65i Ref. I1U02-04 Kit cortavientos - tapetas para dos / cuatro hojas
				
P70CO Ref. I1G70-71 I1G70 Kit estanqueid. hoja gran. I1G71 Kit estanqueid. hoja peq.	S-62 Ref. I1G62 Kit cortavientos - tapetas para dos / cuatro hojas	S-72 Ref. I1G72 Kit cortavientos - tapetas para dos / cuatro hojas	Runner Ref. 4MT30 Kit cortavientos	Runner Ref. 4MK74 Kit ruedas y tapas

			<h2>Barandilla Mixta</h2>	
<p>P65CO</p> <p>Ref. T1G65 Kit cortavientos - tapetas para dos / cuatro hojas</p>	<p>P65CO</p> <p>Ref. GT65E Rueda regulable</p>	<p>P65CO</p> <p>Ref. GT65T Rueda tandem regulable</p>		
<p>Barandilla mixta</p> <p>Ref. E-2 Prolongación barandilla E-2</p>	<p>Barandilla mixta</p> <p>Ref. B12803 Bisagra articulada B12803</p>	<p>Barandilla mixta</p> <p>Ref. E-8 Tapa base E-8</p>	<p>Barandilla mixta</p> <p>Ref. 7200010 Soporte vertical</p>	<p>Barandilla mixta</p> <p>Ref. 7200011 Soporte regulable</p>
<p>Barandilla mixta</p> <p>Ref. T12802D-I Tapeta perfil 12802 D (dx)</p>	<p>Barandilla mixta</p> <p>Ref. T12807 Tapeta perfil 12807</p>	<p>Barandilla mixta</p> <p>Ref. 7200050 Base anclaje fundición</p>	<p>Barandilla mixta</p> <p>Ref. T12801 Tapeta lateral perfil 12801</p>	<p>Barandilla mixta</p> <p>Ref. T12804 Tapeta lateral perfil 12804</p>
<p>Barandilla mixta</p> <p>Ref. SP12803 Soporte pared 12803-12804</p>	<p>Barandilla mixta</p> <p>Ref. T12727 Tornillo perfil pilastra 12727</p>	<p>Barandilla mixta</p> <p>Ref. E12803 Escuadra 90° para perfiles 12803 y 12804</p>	<p>Barandilla mixta</p> <p>Ref. 7200023 Escuadra perfil 8769 * Pendiente modelo nuevo</p>	















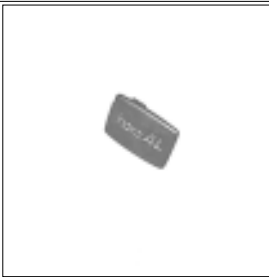



				
Ariane Ref. 1760200-176F200 Soporte Ariane 123 mm 176F200 -> Fijac. frontal 225 mm.	Ariane Ref. 1760400-176F400 Soporte Ariane 323 mm 176F400 -> Fijac. frontal 425 mm.	Ariane Ref. 1760600-176F600 Soporte Ariane 523 mm. 176F600 -> Fijac. frontal 625 mm.	Athys 3 Vallees Ref. DJP25 Junta acristalamiento 3 mm.	Athys 3 Vallees Ref. DJP66 Junta acristalamiento 6 mm
				
Athys 3 Vallees Ref. DJP88 Junta acristalamiento 8 mm.	Ranch Ref. FB226 Unión alargado modelo Ranch	Ranch Ref. FB601 Brida fijación pasamano inferior RANCH a rigidizador	Ranch Ref. FB602 Soporte articulado para pasamano superior RANCH	Ranch Ref. FB603 Soporte combinado con FB602 para pasamano RANCH
				
Ranch Ref. FB604 Brida fijación pasamano inferior RANCH en inclinado	Ranch Ref. FB607 Soporte fijación pared RANCH	Ranch Ref. FB609D-I Tapetas laterales perfil pasamano inferior RANCH	Ranch Ref. FB611 Codo 90° perfil pasamano superior RANCH	Ranch Ref. FB612 Codo 90° perfil pasamano inferior RANCH
				
Ranch Ref. FB615 Unión articulada vertical para pasamanos RANCH	Ranch Ref. FB616 Unión articulada horizontal para pasamanos RANCH	Athys 3 vallees Antares Ranch Ref. FB619 Terminal superior perfil rigidizador R219	Ranch Ref. FB666D-I Codo 90° articulado en entrega subida / bajada RANCH	Ranch Ref. FB667D-I Codo 90° articulado en entrega subida / bajada RANCH









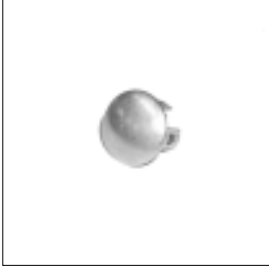





Accesorios HORIZONTAL

Ranch Ref. FB718Z Tapeta lateral pasamano superior RANCH	Fijaciones pilastras Ref. FM12 Tornillo métrico 12 x 90 mm.	Fijaciones a pared Ref. FM8 Tornillo fijación métrico 8 x 20	Athys 3 Vallees Antares Ref. HO040 Unión largo pasamanos	Athys 3 Vallees Antares Ref. HO041 Escuadra 90° pasamanos
Combinación con R219 Ref. HO049 Conjunto base anclaje para fijación frontal a forjado	Barandilla mixta Ref. HO0561 Unión superior pasamano con tubo 45 x 25 mm.	Barandilla mixta Ref. HO0562 Unión superior pasamano con tubo 45x25 y entrega lateral	Athys 3 Vallees Antares Ranch Ref. HO076 Base spal HO202	Athys 3 Vallees Antares Ranch Ref. HO095D-I Soporte fijación a pared pasamano
Athys 3 Vallees Antares Ref. HO105D-I Soporte fijación a pared pasamano	3 Vallees Ref. HO108D-I Soporte fijación a pared perfiles R666 y R667	Athys 3 Vallees Antares Ref. HO110 Escuadra articulada para pasamano	3 Vallees Ref. HO112D-I Tapeta lateral perfiles R666 y R667	Athys 3 Vallees Antares Ranch Ref. HO1201 Spal fijación altura 980 mm. *A sustituir por HO610Z
Separaciones balcón Ref. HO140 Conjunto mordaza para vidrio de mampara balcón	Athys 3 Vallees Antares Ref. HO169D-I Conjunto fijación pasamano mampara balcón	Athys 3 Vallees Antares Ref. HO178 Pieza soporte pasamano a pilastra	Athys 3 Vallees Antares Ranch Ref. HO202 Spal fijación altura 1080 mm. *A sustituir por HO611Z	Athys 3 Vallees Antares Ranch Ref. HO204 Base fijación frontal forjado *A sustituir por HO604Z

				
Athys 3 Vallees Antares Ranch Ref: HO205 Base regulación pies y Spal *A sustituir por HO613	Athys Ref: HO217 Spal 200-45	Athys 3 Vallees Antares Ranch Ref: HO229 Base anclaje sobre forjado *A sustituir por HO612Z	Antares Ref: HO292 Brida fijación pasamano inferior	Athys 3 Vallees Ref: HO319 Base fijación sobre forjado con pilastra bajante
				
Athys 3 Vallees Antares Ref: HO354D-I Soporte fijación articulado a pared de pasamano	3 Vallees Antares Ref: HO355D-I Soporte fijación articulado a pared de perfiles de relleno	Exclusivamente para R460 Ref: HO358 Codo 90° pasamano R460	Exclusivamente para R460 Ref: HO360 Tapeta lateral pasamano	Exclusivamente para R460 Ref: HO364 Tapeta lateral pasamano
				
Athys Ref: HO400 Soporte frontal a pared de pasamano	Exclusivamente para R460 Ref: HO402 Codo articulado graduable de 80° a 137°	Exclusivamente para R460 Ref: HO407 Codo articulado graduable de 133° a 180°	Exclusivamente para R560 Ref: HO469D-I Tapeta lateral pasamano	3 Vallees Ref: HO544 Codo 90° para perfiles R666 y R667
				
3 Vallees Ref: HO552 Escuadra 90° canto redondo para perfiles R666 y R667	Athys Ref: HO555 Brida fijación perfiles RN30 y R630	Athys 3 Vallees Antares Ranch Ref: HO604Z Base fijación frontal a forjado *Sustituye a HO204	Athys Ref: HO606 Accesorio unión alargó perfil R630	Athys 3 Vallees Antares Ranch Ref: HO610Z Spal con tapeta altura 980 mm. *Sustituye a HO1201

Accesorios HORIZONTAL

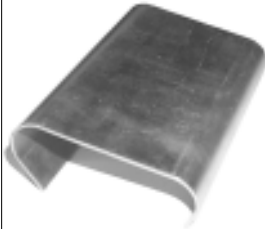
				
Athys 3 Vallees Antares Ranch Ref: HO611Z Spal con tapeta altura 1080 mm. *Sustituye a HO202	Athys 3 Vallees Antares Ranch Ref: HO612Z Base y pie con tapeta *Sustituye a HO229	Fijaciones pilastras Ref: HO613 Base regulación Spal y pies. *Sustituye a HO613	Exclusivamente para R620 Ref: HO620D-I Tapeta lateral pasamano	Exclusivamente para R638 Ref: HO638D-I Tapeta lateral perfiles
				
3 Vallees Antares Ref: HO642 Accesorio unión alargó perfiles R638, R666 y R667	3 Vallees Antares Ref: HO643 Codo 90° para perfiles R638, R666 y R667	Barandilla mixta Ref: HO644 Codo articulado para perfiles R638, R666 y R667	Ariane Ref: HO649 Base regulable para fijación HO650	Ariane Ref: HO650 Base fijación sobre murete
				
Ariane Ref: HO657 Conjunto articulado fijación pasamano a pilastra	Athys Ref: HO658 Conjunto brida articulada fijación R630 y RN30 a pilastra	Athys 3 Vallees Ref: HO692 Roseta central cruz San Andres	Athys 3 Vallees Ref: HO693 Fijación perfil RD649 de cruz San Andres	Athys Ref: HOC60 Fijación sobre Athys de cruz San Andres
				
3 Vallees Ref: HO694 Fijación sobre 3 Vallees de cruz San Andres	Athys Ariane Ref: HO7001 Codo 90° perfiles R630	Athys Ariane Ref: HO705 Soporte fijación a pared perfiles RN30 y R630	Athys Ariane Ref: HO706 Accesorios unión alargó perfil RN30	Athys Ariane Ref: HO708 Tapeta perfil RN30 y R630

				
<p>Ariane</p> <p>Ref HO711 Soporte a pared frontal tubo RN30</p>	<p>Athys 3 Vallees Antares</p> <p>Ref HO740D-I Tapeta lateral pasamano perfiles R720 y R740</p>	<p>Athys Ariane</p> <p>Ref HO743 Codo 90° para perfil RN30</p>	<p>Athys Ariane</p> <p>Ref HO744 Codo articulado para perfil RN30</p>	<p>Ariane</p> <p>Ref HO756 Placa fijación tubo RN30 a pilastra en Ariane</p>
				
<p>Ariane</p> <p>Ref HO778 Unión fijación pilastra a pasamano R460 en Ariane</p>	<p>Athys Ariane</p> <p>Ref HO802 Codo articulado de 117° a 152° para perfiles RN30 y R630</p>	<p>Athys Ariane</p> <p>Ref HO803 Codo articulado de 152° a 178° para perfiles RN30 y R630</p>	<p>Athys Ariane</p> <p>Ref HO843 Codo 90° para perfil R630</p>	<p>Athys Ariane</p> <p>Ref HO844 Codo articulado para perfil R630</p>
				
<p>3 Vallees Antares</p> <p>Ref HO845 Codo articulado para perfil R630</p>	<p>Athys Ariane</p> <p>Ref MH461 Unión alargo pasamano R460</p>	<p>Athys 3 Vallees Antares</p> <p>Ref MH476 Unión alargo pasamano R450</p>	<p>Athys 3 Vallees Antares</p> <p>Ref MH620 Unión alargo pasamano R620</p>	<p>Athys 3 Vallees Antares</p> <p>Ref MH720 Unión alargo pasamano R720</p>
 <p>Athys 3 Vallees Antares</p> <p>Ref MH740 Unión alargo pasamano R740</p>				













Accesorios de puertas jardín HORIZONTAL

				
Puertas Jardín	Puertas Jardín	Puertas Jardín	Puertas Jardín	Puertas Jardín
Ref. 95246 Cierre central dos hojas	Ref. 90784 Tapa superior montante vallas	Ref. 54974-54975 Fijación de apertura puerta	Ref. 95033 Tapón plástico	Ref. 95043A Autoroscante M8
				
Puertas Jardín	Puertas Jardín	Puertas Jardín	Puertas Jardín	Puertas Jardín
Ref. 95044 Contraplaca.	Ref. 95045 Contraplaca	Ref. 95054 Tope central dos hojas	Ref. 95056A Fijación apertura puerta	Ref. 95059 Bisagra eje inferior
				
Puertas Jardín	Puertas Jardín	Puertas Jardín	Puertas Jardín	Puertas Jardín
Ref. 95062 Resbalón cerradura para obra	Ref. 95152 Manubrio puertas	Ref. 95166 Bisagra reforzada	Ref. 95168 Embudo eje bisagra	Ref. 95169 Embudo plano
				
Puertas Jardín	Puertas Jardín	Puertas Jardín	Puertas Jardín	Puertas Jardín
Ref. 95170 Embudo superior central	Ref. 95174 Bisagra regulable	Ref. 95228 Unión tornillos en T central	Ref. 95071 Bombín cerradura	Ref. 90275P Embellecedor bombín

				
Puertas Jardín	Puertas Jardín	Puertas Jardín	Puertas Jardín	Puertas Jardín
Ref. 95078 Soporte superior corredera	Ref. 95079 Conjunto rueda corredera	Ref. 95149 Alargo inferior guia corredera	Ref. 95162 Tope final corredera	Ref. 95171 Resbalón cerradura
				
Puertas Jardín	Puertas Jardín	Puertas Jardín	Puertas Jardín	Puertas Jardín
Ref. 95172-95185 95172 Cerrad. manual reversible 95185 Cerrad. electric. reversible	Ref. 95184 Perfil cierre corredera (L=2mts)	Ref. 95187 Cerradura hoja corredera	Ref. 95195 Burllete adhesivo (6 mts.)	Ref. 95197 Tapa superior tubo cuadrado 100
				
Puertas Jardín	Puertas Jardín	Puertas Jardín	Puertas Jardín	Puertas Jardín
Ref. 95231 Goma para corredera motorizada	Ref. 95125 Escuadra unión travesaño vertical en corredera perfiles 95102.	Ref. 95217 Rodillo guía puerta corredera.	Ref. 95242 Tapeta perfil 95000	Ref. 95243 Tapeta perfil 95102
				
Puertas Jardín	Puertas Jardín	Puertas Jardín	Puertas Jardín	Puertas Jardín
Ref. 95555 Perfil curvado mod. Tahiti/Hawai Medida útil 2060, medida total 2500 mm.	Ref. 95312 Golpete eléctrico	Ref. 95241 Embudo inferior puerta corredera	Ref. HO1034D-I Tapeta perfil 95240	Ref. 95221 Conjunto pilar corredera autoportante.

Herrajes Mallorquina Oscura

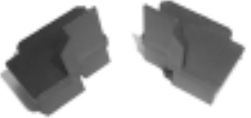
				
Mallorquina oscura	Mallorquina oscura	Mallorquina oscura	Mallorquina oscura	Mallorquina oscura
Ref: M14072 Bisagra central cruce	Ref: M14094 Soporte pared fijo	Ref: M14128 Terminal	Ref: M14132 Terminal	Ref: M14140 Eje soporte bisagra L=147 mm.
				
Mallorquina oscura	Mallorquina oscura	Mallorquina oscura	Mallorquina oscura	Mallorquina oscura
Ref: M14144 Eje soporte bisagra L=172 mm.	Ref: M14200 Conjunto maneta	Ref: M14204 Conjunto maneta	Ref: M14248 Soporte fijación puerta	Ref: M14360 Maneta pletina
				
Mallorquina oscura	Mallorquina oscura	Mallorquina oscura	Mallorquina oscura	Mallorquina oscura
Ref: M14376 Bisagra soporte fijación	Ref: M14380 Bisagra soporte fijación	Ref: M14416 Eje soporte bisagra L=145 mm.	Ref: M14420 Eje soporte bisagra L=170 mm.	Ref: M14474 Soporte pared fijación hoja
				
Mallorquina oscura	Mallorquina oscura	Mallorquina oscura	Mallorquina oscura	Mallorquina oscura
Ref: M23705 Casquillo empotrado	Ref: M41882 Espesor bisagra	Ref: M42306 Taco para eje	Ref: M42929 Tope cierre pared	Ref: M43559 Tope cierre fijación

				
<p>Mallorquina oscura</p> <p>Ref. M43648 Guia varilla</p>	<p>Mallorquina oscura</p> <p>Ref. M52627 Plantilla bisagra</p>	<p>Mallorquina oscura</p> <p>Ref. M94101 Varilla accionamiento 2400 mm.</p>	<p>Mallorquina oscura</p> <p>Ref. M94126 Varilla accionamiento 1400 mm.</p>	<p>Mallorquina oscura</p> <p>Ref. M94134 Varilla accionamiento 2600 mm.</p>
				
<p>Mallorquina oscura</p> <p>Ref. 14210 Encuentro de cierre</p>	<p>Mallorquina oscura</p> <p>Ref. 94148 Leva apoyo 2 hojas</p>	<p>Mallorquina oscura</p> <p>Ref. 94151 Gancho para encuentro de cierre</p>	<p>Mallorquina oscura</p> <p>Ref. 94153 Encuentro para cierre</p>	<p>Mallorquina oscura</p> <p>Ref. 94163 Gancho de cierre</p>
				
<p>Mallorquina oscura</p> <p>Ref. 6BT00 Tapas acoplamiento central</p>	<p>Mallorquina oscura</p> <p>Ref. 6BT30 Tapa terminal 21730</p>			

Herrajes Wood

Wood	Wood	Wood	Wood	Wood
Ref: 9FR45 Fresas travesaño Wood	Ref: I12001 Conjunto ángulos reenvío * Consultar plazo	Ref: I12002 Conjunto ángulos reenvío * Consultar plazo	Ref: I12003 Conjunto ángulos reenvío * Consultar plazo	Ref: I21926 Accionamiento puerta H = 1850 - 2100 mm.
Wood	Wood	Wood	Wood	Wood
Ref: I21927 Accionamiento puerta H = 2100-2350 mm.	Ref: I23829A Falso compas	Ref: I990001 Bloqueo cerradura	Ref: M10590 Conjunto rodamientos	Ref: M10617 Kit embellecedor bisagra Dx
Wood	Wood	Wood	Wood	Wood
Ref: M10618 Kit embellecedor bisagra Sx	Ref: M10993 Puntal terminal	Ref: M10994 Prolongación 250 mm.	Ref: M10995 Prolongación 400-600 mm.	Ref: M10999 Angulo reenvío oscilobatiente 400-1600 mm.
Wood	Wood	Wood	Wood	Wood
Ref: M11000 Angulo reenvío oscilobatiente 280-650 mm.	Ref: M11002 Angulo reenvío especial oscilobatiente 280-650 mm.	Ref: M11009 Puntal terminal	Ref: M11023 Plantilla accionamiento cremona	Ref: M11318 Pernio de cierre
Wood	Wood	Wood	Wood	Wood



Wood

Ref. **M20198**
Accionamiento cremona
H = 950 - 1200 mm.



Wood

Ref. **M20199**
Accionamiento cremona
H = 1350 - 1600 mm.



Wood

Ref. **M20200**
Accionamiento cremona
H = 1950 - 2200 mm.



Wood

Ref. **M20990**
Cierre suplementario 1250-1500

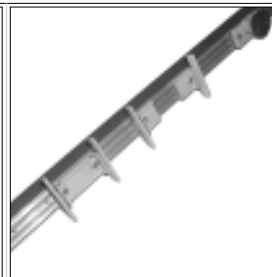

Wood

Ref. **M21398**
Plantilla encuentro cierres



Wood

Ref. **M21913**
Bisagra marco superior /
intermedia



Wood

Ref. **M21931**
Bisagra inferior marco

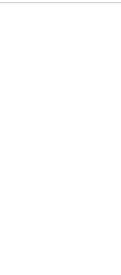

Wood

Ref. **M21982**
Cierre suplementario
750 - 1050 mm.



Wood

Ref. **M21983**
Cierre suplementario
1050 - 1300 mm.



Wood

Ref. **M21984**
Cierre suplementario
1250 - 1500 mm.

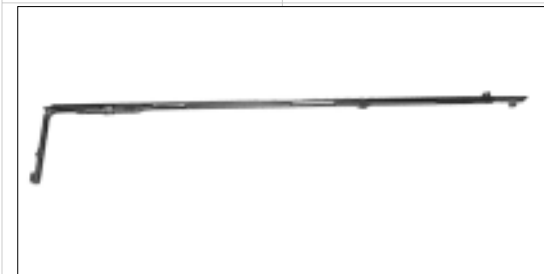

Wood

Ref. **M21985**
Cierre suplementario
1500 - 1750 mm.

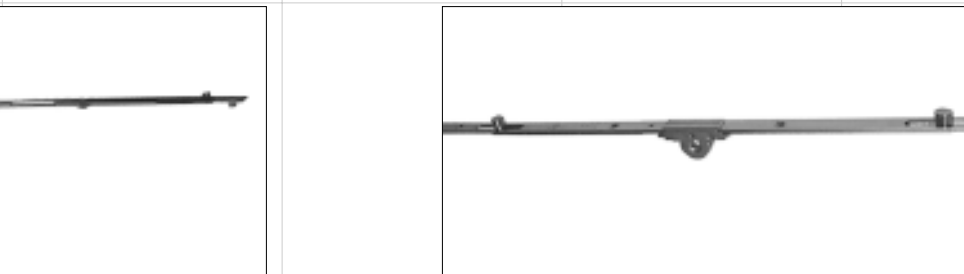

Wood

Ref. **M21986**
Cierre suplementario
1750 - 2350 mm.



Wood

Ref. **M2221**
Accionamiento basculante
500 - 700 mm.



Wood

Ref. **M2222**
Accionamiento basculante
700 - 1000 mm.



Wood

Ref. **M2223**
Accionamiento basculante
1000 - 1400 mm.



Wood

Ref. **M22402**
Cierre elevable



Wood

Ref. **M22403**
Cierre elevable



Wood

Ref. **M22548**
Pasador inferior 2ª hoja



Wood



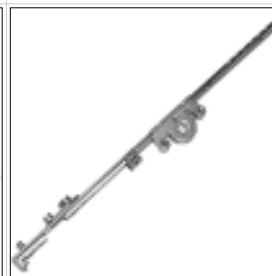





Ref. **M22962**
Pasador superior 2ª hoja

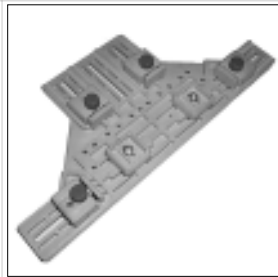

Wood

Ref. **M23521**
Accionamiento cremona

Herrajes Wood

				
Wood	Wood	Wood	Wood	Wood
Ref: M23523 Accionamiento cremona H = 800 - 1000 mm.	Ref: M23524 Accionamiento cremona H = 1000 - 1250 mm.	Ref: M23525 Accionamiento cremona H = 1250 - 1500 mm.	Ref: M23526 Accionamiento cremona H = 1500 - 1750 mm.	Ref: M23527 Accionamiento cremona H = 1850 - 2100 mm.
				
Wood	Wood	Wood	Wood	Wood
Ref: M23528 Accionamiento cremona H = 2100 - 2350 mm.	Ref: M23711 Cierre pasador	Ref: M24658 Maneta oscilo paralela	Ref: M24897 Accionamiento cremona H = 600 - 800 mm.	Ref: M25220 Bloqueo accionamiento
				
Wood	Wood	Wood	Wood	Wood
Ref: M28273 Componente horizontal L = 530 mm	Ref: M28274 Componente horizontal L = 790 mm	Ref: M28275 Componente horizontal L = 1280 mm	Ref: M28276 Componente altura posterior H = 1125 mm	Ref: M28277 Componente altura posterior H = 1525 mm
				
Wood	Wood	Wood	Wood	Wood
Ref: M28278 Componente altura posterior H = 2010 mm	Ref: M28597 Plantilla bisagra	Ref: M28744 Maneta dorada practicable	Ref: M28773 Guia deslizante posterior	Ref: M28774 Guia deslizante posterior



Wood

Ref. **M28791**
Encuentro



Wood

Ref. **M29442**
Guia oscilobatiente
L 280 - 429 mm



Wood

Ref. **M29443**
Guia oscilobatiente
L = 430 - 630 mm



Wood

Ref. **M29444**
Guia oscilobatiente
L = 601 - 800 mm

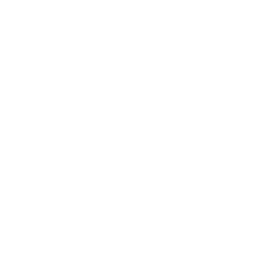

Wood

Ref. **M29445**
Guia oscilobatiente
L = 801 - 1050



Wood

Ref. **M29446**
Guia oscilobatiente
L = 1051 - 1300 mm



Wood

Ref. **M30765**
Cuadradillo cremona

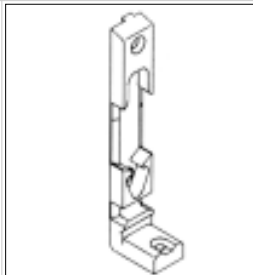

Wood

Ref. **M33107**
Encuentro cierre oscilo inferior



Wood

Ref. **M34107**
Encuentro cierre marco

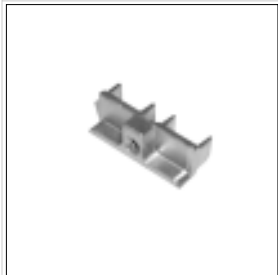

Wood

Ref. **M34710**
Encuentro cierre acoplamiento central

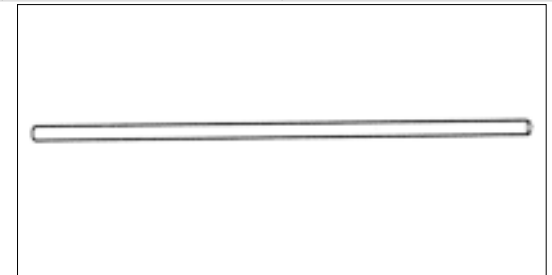

Wood

Ref. **M37647**
Barra unión rodamiento

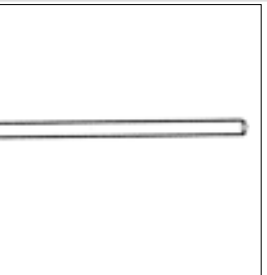

Wood

Ref. **M37648**
Barra unión rodamiento



Wood

Ref. **M38661**
Eje pernio superior / central

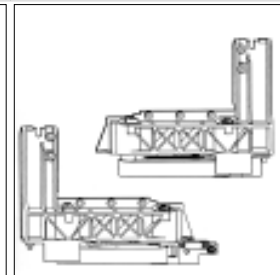

Wood

Ref. **M40849**
Conjunto ruedas 150 kgs Sx

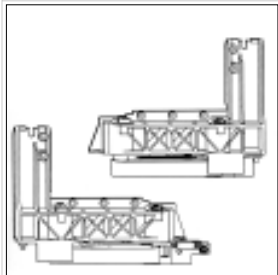

Wood

Ref. **M40850**
Conjunto ruedas 150 kgs Dx

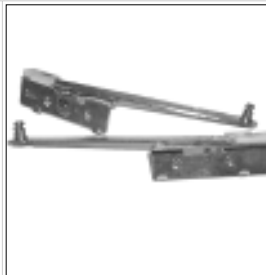

Wood

Ref. **M40901**
Compas superior oscilo paralela

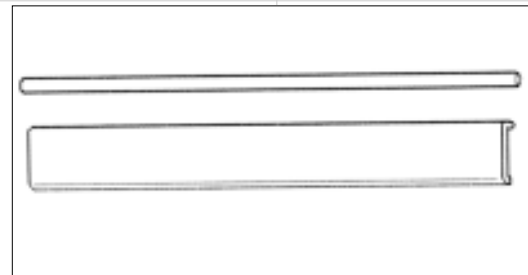

Wood

Ref. **M41053**
Conjunto tapeta ruedas O.P.
L = 1150 mm

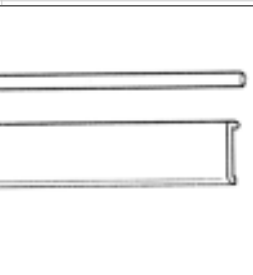

Wood

Ref. **M41057**
Conjunto tapeta ruedas O.P.
L = 1650 mm

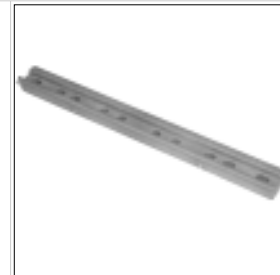

Wood

Ref. **M41263**
Espesor para pasador

Herrajes Wood

<p>Wood</p> <p>Ref: M41985 Bloqueo accionamiento</p>	<p>Wood</p> <p>Ref: M42098 Embelecedor bisagra intermedia marco</p>	<p>Wood</p> <p>Ref: M42106 Embelecedor bisagra intermedia hoja</p>	<p>Wood</p> <p>Ref: M43645 Conjunto carro O.P. Dx</p>	<p>Wood</p> <p>Ref: M43646 Conjunto carro O.P. Sx</p>
<p>Wood</p> <p>Ref: M43654 Conjunto guia oscilo paralela L = 1960 mm</p>			<p>Wood</p> <p>Ref: M43657 Conjunto guia oscilo paralela L = 3460 mm</p>	<p>Wood</p> <p>Ref: M50603 Accionamiento cremona H = 431 - 680 mm</p>
<p>Wood</p> <p>Ref: M50606 Accionamiento cremona H = 801 - 1000 mm</p>			<p>Wood</p> <p>Ref: M50609 Accionamiento cremona H = 1501 - 1750 mm</p>	<p>Wood</p> <p>Ref: M50610 Accionamiento cremona H = 1851 - 2100 mm</p>
<p>Wood</p> <p>Ref: M50611 Accionamiento cremona H = 1601 - 1850 mm</p>	<p>Wood</p> <p>Ref: M50612 Accionamiento cremona H = 2101 - 2350 mm</p>	<p>Wood</p> <p>Ref: M52201 Base bisagra intermedia hoja</p>	<p>Wood</p> <p>Ref: M52615 Bisagra superior / infermedia hoja</p>	<p>Wood</p> <p>Ref: M52617 Bisagra inferior hoja Dx</p>



Wood	Wood	Wood	Wood	Wood
Ref. M52617 Bisagra inferior hoja Sx	Ref. M53562 Cerradura H = 2400 mm	Ref. M95013 Encuentro hoja	Ref. M96460 Cierre doble	Ref. X49009 Embelledor maneta





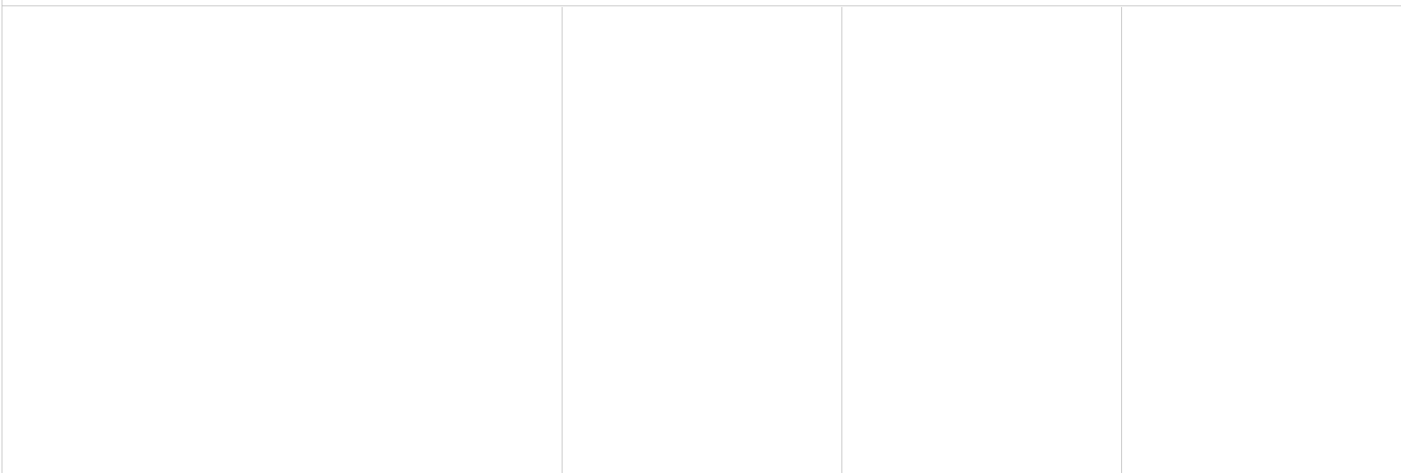
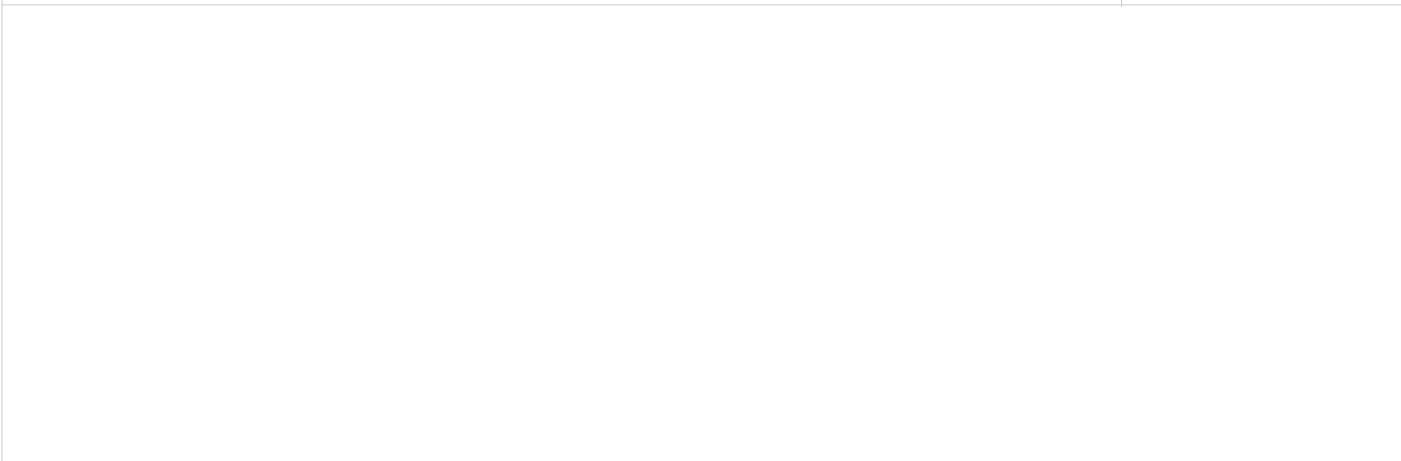







Wood	Wood	Wood
Ref. X49011 Manilla	Ref. X49012 Uñero exterior	Ref. M10287 Conjunto manetas puerta



Accesorios Euro Runner 250tt

Euro Runner 250tt	Euro Runner 250tt	Euro Runner 250tt	Euro Runner 250tt	Euro Runner 250tt
Ref. 40GU01 Poliamida porta junta 40GU03	Ref. 40GU02 Junta estanquidad guia superior	Ref. 4GU03 Junta estanquidad hoja	Ref. 4GU04 Junta estanquidad central marco lateral / superior	Ref. 4GU05 Junta estanquidad hoja
Euro Runner 250tt	Euro Runner 250tt	Euro Runner 250tt	Euro Runner 250tt	Euro Runner 250tt
Ref. 40GU06 Junta estanquidad guia superior	Ref. D910065 Junta estanquidad	Ref. 40TP01 Clip de fijación perfil cruce	Ref. 40TP02 Puente estanquidad superior	Ref. 40TP03 Tapón HS inferior
Euro Runner 250tt	Euro Runner 250tt	Euro Runner 250tt	Euro Runner 250tt	Euro Runner 250tt
Ref. 40TP04 Tapeta guia posterior cruce	Ref. 40TP05 Tapeta guia anterior	Ref. 40TP06 Tope	Ref. 40TP07 Tapa cruce inferior	Ref. 40TP08 Goma tapeta inferior
Euro Runner 250tt	Euro Runner 250tt	Euro Runner 250tt	Euro Runner 250tt	Euro Runner 250tt
Ref. 40TP09 Terminal corredera	Ref. 40TP10 Terminal corredera	Ref. 40VA01 Junta estanquidad central	Ref. IAS88 Escuadra de alineamiento	Ref. 40SQ01 Escuadra refuerzo

				
<p>Euro Runner 250tt</p> <p>Ref. M37647 Escuadra de tetones para marco</p>	<p>Euro Runner 250tt</p> <p>Ref. M37648 Escuadra de tetones para hoja</p>	<p>Euro Runner 250tt</p> <p>Ref. M10059 Conjunto carros elevable de 250 Kgs</p>	<p>Euro Runner 250tt</p> <p>Ref. M22402 Cerradura de 1775 a 2060 mm</p>	<p>Euro Runner 250tt</p> <p>Ref. M22403 Cerradura de 1925 a 2560 mm.</p>
				
<p>Euro Runner 250tt</p> <p>Ref. M37647 Varilla unión carros de 1100 mm</p>	<p>Euro Runner 250tt</p> <p>Ref. M37648 Varilla unión carros de 1600 mm.</p>	<p>Euro Runner 250tt</p> <p>Ref. M11318 Punto de cierre lateral</p>	<p>Euro Runner 250tt</p> <p>Ref. M13341 Manillón + uñero exterior Plata</p>	<p>Euro Runner 250tt</p> <p>Ref. M13343 Manillón interior / exterior Plata</p>

Histórico Catálogo General



* Catálogo General Edición 002-R01*****

Página 46

Introducción de marco 27003

Página 50

Anulado perfil 21512

Actualizado dibujo 21521

Página 51

Actualizado dibujo 21527

Página 53

Actualizados dibujos 21645, 24427 y 24428

Página 54

Anulado perfil 21645

Actualizado dibujo 24573

Página 70

Rectificada tabla de junquillos (124556 corregido a 124555)

Página 77

Anulado perfil 27317

Página 84

Corregida Fotografía correcta escuadra 9652

Página 86

Introducida referencia 90AE01

Página 87

Corregida referencia 1GM3050 (en catálogo 1GM1142 duplicada)

Página 89

Anuladas referencias 634 y A509

Página 95

Corregidas descripciones en pasadores 13D13 y 13D12

Corregida descripción 4MM65 - 4MM66

4MM65 -> 1,80 mts

4MM66 -> 1 mts

Página 100

Actualizadas referencias y fotos soportes ariane
