



CATÁLOGO GENERAL 2008



CATÁLOGO GENERAL 2008 | perfiles









**ABITHAL**

**horizAL**

# Perfiles

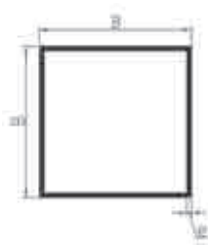
<u>Producto</u>	<u>Pág</u>
Normalizados	2
Chapas	3
Angulos decorados	4
Guias persiana	6
Guia vitrina y división oficina	7
Revestimientos	8
Barandilla mixta	9
Barandilla Horizontal	10
Corredera S-62	14
Corredera S-72	17
Corredera P70CO	20
Corredera P70CO tt	22
Corredera Abithal Runner	24
Corredera Abithal Runner tt	27
Corredera Euro Runner 250tt	30
Practicable Abithal Euro 40	32
Practicable Abithal Green	38
Practicable Abithal Open Green	44
Practicable Abithal Euro-Keeper 45	45
Practicable Abithal Keeper 61-68	49
Abithal Wood	53
Junquillos cámara europea	57
Euro mallorquina	60
Plegable Garden	65
Abithal Wall	67

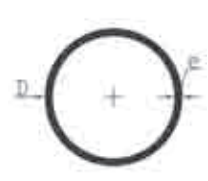
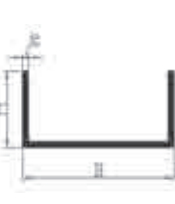

	<p><b>Pletinas</b></p> <table border="1"> <thead> <tr> <th>H</th> <th>e</th> </tr> </thead> <tbody> <tr><td>15</td><td>3</td></tr> <tr><td>20</td><td>3</td></tr> <tr><td>20</td><td>10</td></tr> <tr><td>25</td><td>3</td></tr> <tr><td>30</td><td>3</td></tr> <tr><td>30</td><td>5</td></tr> <tr><td>30</td><td>10</td></tr> <tr><td>40</td><td>4</td></tr> <tr><td>40</td><td>10</td></tr> <tr><td>50</td><td>5</td></tr> <tr><td>60</td><td>10</td></tr> <tr><td>80</td><td>10</td></tr> <tr><td>100</td><td>10</td></tr> </tbody> </table>	H	e	15	3	20	3	20	10	25	3	30	3	30	5	30	10	40	4	40	10	50	5	60	10	80	10	100	10		<p><b>Tubos rectangulares</b></p> <table border="1"> <thead> <tr> <th>H</th> <th>B</th> <th>e</th> </tr> </thead> <tbody> <tr><td>20</td><td>10</td><td>1,3</td></tr> <tr><td>30</td><td>15</td><td>1,3</td></tr> <tr><td>30</td><td>20</td><td>1,3</td></tr> <tr><td>40</td><td>20</td><td>1,3</td></tr> <tr><td>40</td><td>25</td><td>1,5</td></tr> <tr><td>50</td><td>25</td><td>1,5</td></tr> <tr><td>50</td><td>30</td><td>2</td></tr> <tr><td>60</td><td>20</td><td>1,3</td></tr> <tr><td>60</td><td>30</td><td>1,3</td></tr> <tr><td>60</td><td>40</td><td>1,3</td></tr> <tr><td>70</td><td>20</td><td>1,3</td></tr> <tr><td>80</td><td>20</td><td>1,3</td></tr> <tr><td>80</td><td>40</td><td>1,3</td></tr> <tr><td>80</td><td>60</td><td>2</td></tr> <tr><td>100</td><td>40</td><td>1,5</td></tr> <tr><td>100</td><td>45</td><td>2</td></tr> <tr><td>120</td><td>40</td><td>1,7</td></tr> <tr><td>150</td><td>80</td><td>2,7</td></tr> </tbody> </table>	H	B	e	20	10	1,3	30	15	1,3	30	20	1,3	40	20	1,3	40	25	1,5	50	25	1,5	50	30	2	60	20	1,3	60	30	1,3	60	40	1,3	70	20	1,3	80	20	1,3	80	40	1,3	80	60	2	100	40	1,5	100	45	2	120	40	1,7	150	80	2,7
H	e																																																																																							
15	3																																																																																							
20	3																																																																																							
20	10																																																																																							
25	3																																																																																							
30	3																																																																																							
30	5																																																																																							
30	10																																																																																							
40	4																																																																																							
40	10																																																																																							
50	5																																																																																							
60	10																																																																																							
80	10																																																																																							
100	10																																																																																							
H	B	e																																																																																						
20	10	1,3																																																																																						
30	15	1,3																																																																																						
30	20	1,3																																																																																						
40	20	1,3																																																																																						
40	25	1,5																																																																																						
50	25	1,5																																																																																						
50	30	2																																																																																						
60	20	1,3																																																																																						
60	30	1,3																																																																																						
60	40	1,3																																																																																						
70	20	1,3																																																																																						
80	20	1,3																																																																																						
80	40	1,3																																																																																						
80	60	2																																																																																						
100	40	1,5																																																																																						
100	45	2																																																																																						
120	40	1,7																																																																																						
150	80	2,7																																																																																						
	<p><b>Tubos cuadrados</b></p> <table border="1"> <thead> <tr> <th>B</th> <th>e</th> </tr> </thead> <tbody> <tr><td>20</td><td>1,3</td></tr> <tr><td>25</td><td>1,3</td></tr> <tr><td>30</td><td>1,3</td></tr> <tr><td>35</td><td>1,3</td></tr> <tr><td>40</td><td>1,3</td></tr> <tr><td>45</td><td>1,5</td></tr> <tr><td>50</td><td>1,5</td></tr> <tr><td>60</td><td>1,5</td></tr> <tr><td>70</td><td>1,5</td></tr> <tr><td>80</td><td>1,8</td></tr> <tr><td>100</td><td>1,8</td></tr> <tr><td>100</td><td>4</td></tr> <tr><td>150</td><td>5</td></tr> </tbody> </table>	B	e	20	1,3	25	1,3	30	1,3	35	1,3	40	1,3	45	1,5	50	1,5	60	1,5	70	1,5	80	1,8	100	1,8	100	4	150	5		<p><b>Angulos lados iguales</b></p> <table border="1"> <thead> <tr> <th>B</th> <th>e</th> </tr> </thead> <tbody> <tr><td>15</td><td>1,3</td></tr> <tr><td>20</td><td>1,3</td></tr> <tr><td>25</td><td>1,3</td></tr> <tr><td>30</td><td>1,3</td></tr> <tr><td>35</td><td>1,3</td></tr> <tr><td>40</td><td>1,3</td></tr> <tr><td>40</td><td>2,7</td></tr> <tr><td>50</td><td>1,5</td></tr> <tr><td>60</td><td>1,5</td></tr> <tr><td>60</td><td>7</td></tr> </tbody> </table>	B	e	15	1,3	20	1,3	25	1,3	30	1,3	35	1,3	40	1,3	40	2,7	50	1,5	60	1,5	60	7																																			
B	e																																																																																							
20	1,3																																																																																							
25	1,3																																																																																							
30	1,3																																																																																							
35	1,3																																																																																							
40	1,3																																																																																							
45	1,5																																																																																							
50	1,5																																																																																							
60	1,5																																																																																							
70	1,5																																																																																							
80	1,8																																																																																							
100	1,8																																																																																							
100	4																																																																																							
150	5																																																																																							
B	e																																																																																							
15	1,3																																																																																							
20	1,3																																																																																							
25	1,3																																																																																							
30	1,3																																																																																							
35	1,3																																																																																							
40	1,3																																																																																							
40	2,7																																																																																							
50	1,5																																																																																							
60	1,5																																																																																							
60	7																																																																																							
	<p><b>Tubos redondos</b></p> <table border="1"> <thead> <tr> <th>D</th> <th>e</th> </tr> </thead> <tbody> <tr><td>16</td><td>1,5</td></tr> <tr><td>20</td><td>1,5</td></tr> <tr><td>25</td><td>1,5</td></tr> <tr><td>30</td><td>2</td></tr> <tr><td>40</td><td>2</td></tr> <tr><td>50</td><td>2</td></tr> <tr><td>60</td><td>1,8</td></tr> <tr><td>70</td><td>2</td></tr> <tr><td>80</td><td>2,5</td></tr> <tr><td>100</td><td>2,8</td></tr> </tbody> </table>	D	e	16	1,5	20	1,5	25	1,5	30	2	40	2	50	2	60	1,8	70	2	80	2,5	100	2,8		<p><b>Ues</b></p> <table border="1"> <thead> <tr> <th>H</th> <th>B</th> <th>e</th> </tr> </thead> <tbody> <tr><td>10</td><td>10</td><td>1,5</td></tr> <tr><td>15</td><td>15</td><td>1,3</td></tr> <tr><td>20</td><td>15</td><td>1,8</td></tr> <tr><td>20</td><td>20</td><td>1,3</td></tr> <tr><td>25</td><td>25</td><td>1,3</td></tr> <tr><td>15</td><td>30</td><td>1,5</td></tr> <tr><td>20</td><td>40</td><td>1,5</td></tr> <tr><td>40</td><td>40</td><td>2</td></tr> <tr><td>25</td><td>50</td><td>1,5</td></tr> <tr><td>20</td><td>60</td><td>1,7</td></tr> </tbody> </table>	H	B	e	10	10	1,5	15	15	1,3	20	15	1,8	20	20	1,3	25	25	1,3	15	30	1,5	20	40	1,5	40	40	2	25	50	1,5	20	60	1,7																														
D	e																																																																																							
16	1,5																																																																																							
20	1,5																																																																																							
25	1,5																																																																																							
30	2																																																																																							
40	2																																																																																							
50	2																																																																																							
60	1,8																																																																																							
70	2																																																																																							
80	2,5																																																																																							
100	2,8																																																																																							
H	B	e																																																																																						
10	10	1,5																																																																																						
15	15	1,3																																																																																						
20	15	1,8																																																																																						
20	20	1,3																																																																																						
25	25	1,3																																																																																						
15	30	1,5																																																																																						
20	40	1,5																																																																																						
40	40	2																																																																																						
25	50	1,5																																																																																						
20	60	1,7																																																																																						
	<p><b>Angulos lados desiguales</b></p> <table border="1"> <thead> <tr> <th>B</th> <th>H</th> <th>e</th> </tr> </thead> <tbody> <tr><td>20</td><td>10</td><td>1,3</td></tr> <tr><td>25</td><td>15</td><td>1,5</td></tr> <tr><td>30</td><td>20</td><td>1,5</td></tr> <tr><td>35</td><td>15</td><td>1,3</td></tr> <tr><td>40</td><td>20</td><td>1,3</td></tr> <tr><td>50</td><td>25</td><td>1,3</td></tr> <tr><td>60</td><td>40</td><td>1,5</td></tr> <tr><td>80</td><td>40</td><td>1,5</td></tr> <tr><td>60</td><td>130</td><td>2</td></tr> </tbody> </table>	B	H	e	20	10	1,3	25	15	1,5	30	20	1,5	35	15	1,3	40	20	1,3	50	25	1,3	60	40	1,5	80	40	1,5	60	130	2		<p><b>Tes</b></p> <table border="1"> <thead> <tr> <th>H</th> <th>B</th> <th>e</th> </tr> </thead> <tbody> <tr><td>20</td><td>20</td><td>1,3</td></tr> <tr><td>25</td><td>25</td><td>1,3</td></tr> <tr><td>30</td><td>30</td><td>2</td></tr> <tr><td>40</td><td>40</td><td>1,8</td></tr> </tbody> </table>	H	B	e	20	20	1,3	25	25	1,3	30	30	2	40	40	1,8																																								
B	H	e																																																																																						
20	10	1,3																																																																																						
25	15	1,5																																																																																						
30	20	1,5																																																																																						
35	15	1,3																																																																																						
40	20	1,3																																																																																						
50	25	1,3																																																																																						
60	40	1,5																																																																																						
80	40	1,5																																																																																						
60	130	2																																																																																						
H	B	e																																																																																						
20	20	1,3																																																																																						
25	25	1,3																																																																																						
30	30	2																																																																																						
40	40	1,8																																																																																						

## LAS CHAPAS LACADAS Y ANODIZADAS SE SUMINISTRAN CON PROTECCIÓN PLÁSTICA

También se puede suministrar medidas especiales (consultar plazo de entrega)

### Chapas

Espesor mm.	Peso teórico por chapa 2000x1000	Peso teórico por chapa 3000x1250
1	5,6 kgs	10,5 kgs
1,5	8,4 kgs	15,8 kgs
2	11,2 kgs	21 kgs
3	16,8 kgs	—

### Sandwich

Composición	Dimensiones
0,8+19+0,8	2000x1000

### Unipanel

Composición	Dimensiones
0,8+10	3000x1250
0,8+10	3000x310

### Sandwich rejilla ventilación

Composición	Dimensiones
0,8+15+0,8	800x200

### Chapa Damero



Espesor mm.	Dimensiones
3 + palillo	2000x1000

### Chapa Gofrada

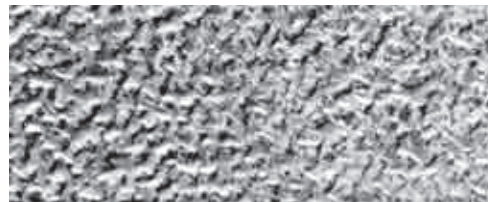

Espesor	Dimensiones
0,6	2000x1000

**Disponemos de stock de paneles LARSON para recubrimientos de fachadas.**



 <p>Ref. <b>6465</b> Base chapa registro.</p>	 <p>Ref. <b>9062</b> Angulo de 90x62</p>	 <p>Ref. <b>10587</b> Perfil para registro</p>	 <p>Ref. <b>21350</b> Angulo para registro</p>
 <p>Ref. <b>21351</b> Base registro.</p>	 <p>Ref. <b>24444</b> Perfil cajón registro.</p>	 <p>Ref. <b>62021</b> Perfil fijación forro S-62</p>	 <p>Ref. <b>62022</b> Perfil fijación forro S-62</p>
 <p>Ref. <b>65019</b> Angulo curvo.</p>	 <p>Ref. <b>65020</b> Angulo curvo.</p>	 <p>Ref. <b>65021</b> Angulo curvo</p>	 <p>Ref. <b>65031</b> Angulo curvo.</p>

# Angulos decorados

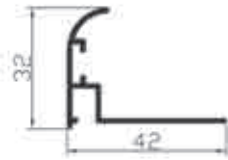

Ref. **65018**  
Angulo para registro.

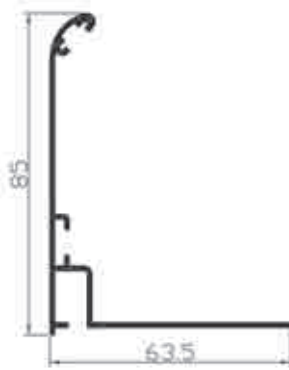

Ref. **65022**  
Angulo para registro.

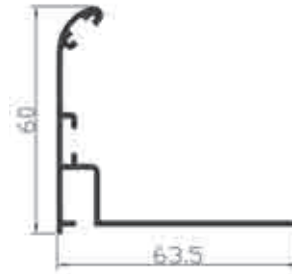

Ref. **65023**  
Angulo para registro

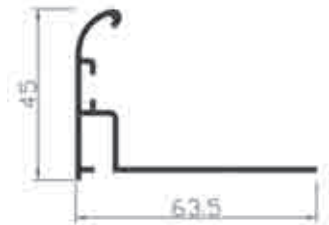

Ref. **65024**  
Angulo para registro.

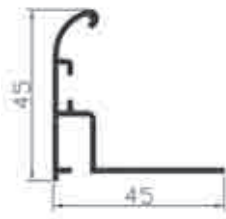

Ref. **65025**  
Angulo para registro



Ref. **65026**  
Base registro.

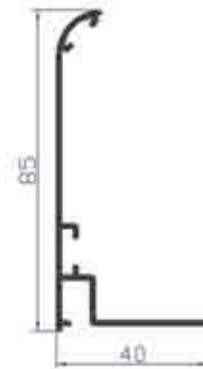

Ref. **65032**  
Angulo para registro.

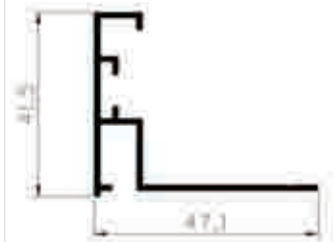

Ref. **65041**  
Angulo para registro.

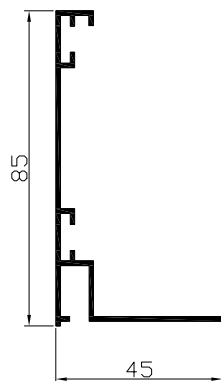

Ref. **65042**  
Angulo para registro.

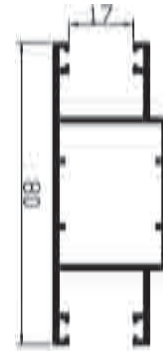
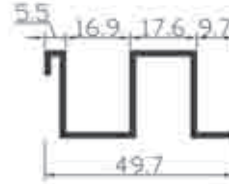
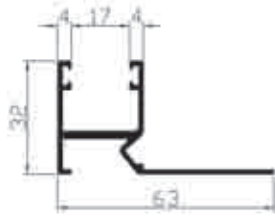
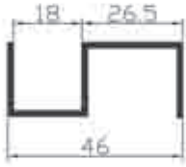

Ref. **752**  
Guia persiana 752

Ref. **1059**  
Guia de persiana 1059

Ref. **5318**  
Guia de persiana 5318  
**\*Consultar stock.**

Ref. **7311**  
Guia de persiana doble 7311

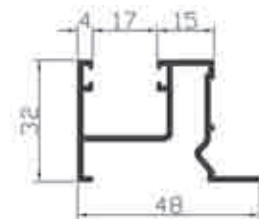
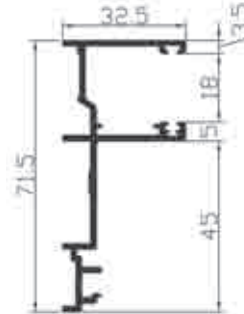
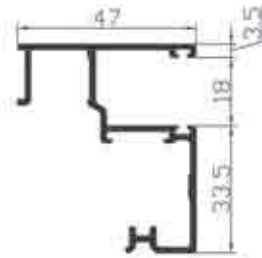

Ref. **10323**  
Guia de persiana 10323

Ref. **2401**  
Guia de persiana 2401  
**\*Sobre pedido**



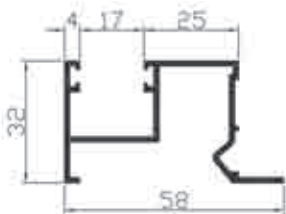

Ref. **2402**  
Guia de persiana 2402  
**\*Sobre pedido**

Ref. **24440**  
Guia de persiana 24440

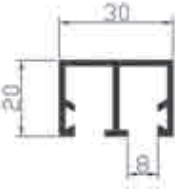
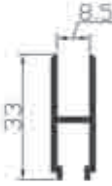

Ref. **24560**  
Guia de persiana 24560

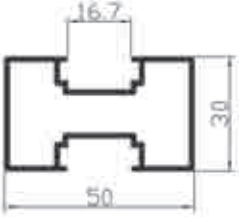
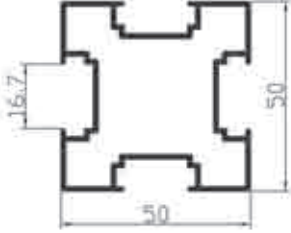

 <p>Ref. <b>Guia Inox 30</b> Guia Inox de 30 mm.</p>	 <p>Ref. <b>5030</b> Guia superior</p>	 <p>Ref. <b>5031</b> Hoja casaca</p>	 <p>Ref. <b>5032</b> Guia aluminio de 30 mm. <b>Opción en Inox</b></p>
 <p>Ref. <b>5033</b> Perfil U lateral</p>	 <p>Ref. <b>5035</b> Perfil U lateral</p>	 <p>Ref. <b>5045</b> Hoja casaca</p>	 <p>Ref. <b>10466</b> Perfil travesaño <b>*Consultar stock</b></p>
 <p>Ref. <b>10467</b> Perfil montante <b>*Consultar stock</b></p>			



Ref. **503**  
Lama fija 50x10



Ref. **713**  
Perfil de revestimiento



Ref. **1306**  
Perfil tubular de revestimiento

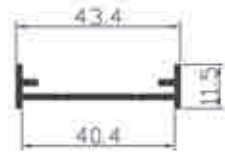

Ref. **2852**  
Marco para lama 2853



Ref. **2853**  
Lama fija

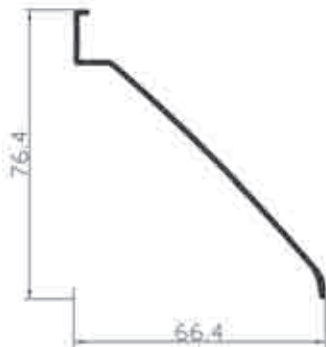

Ref. **R270**  
Lama fija

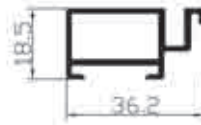

Ref. **7014**  
Perfil para premarco

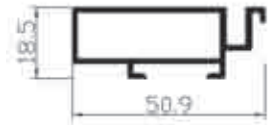

Ref. **7015**  
Perfil para premarco

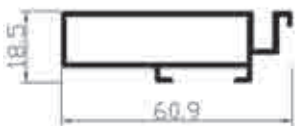

Ref. **7016**  
Perfil para premarco

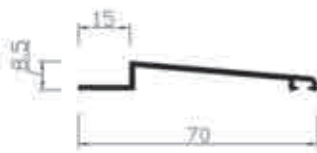

Ref. **PC550**  
Perfil goterón

# Barandilla mixta

 <p>Ref <b>2558</b> Barrote ovalado</p>	 <p>Ref <b>5745 - 7956</b> 5745 -&gt; Barrote rectangular 7956 -&gt; Barrote cuadrado</p>	 <p>Ref <b>9797 - 9798</b> 9797 -&gt; Funda para montante de hierro 9798 -&gt; Barrote</p>	 <p>Ref <b>12727</b> Perfil rigidizador de barandilla</p>
 <p>Ref <b>12801</b> Pasamano superior curvado</p>	 <p>Ref <b>12802</b> Pasamano con hueco para vidrio</p>	 <p>Ref <b>12803</b> Base pasamano superior</p>	 <p>Ref <b>12804</b> Pasamano inferior</p>
 <p>Ref <b>12805</b> Tapeta pasamano inferior</p>	 <p>Ref <b>12806</b> Perfil para vidrio</p>	 <p>Ref <b>12807</b> Perfil inferior para vidrio</p>	 <p>Ref <b>12808</b> Pasamano plano</p>

## DETALLES DE FIJACION A FORJADO

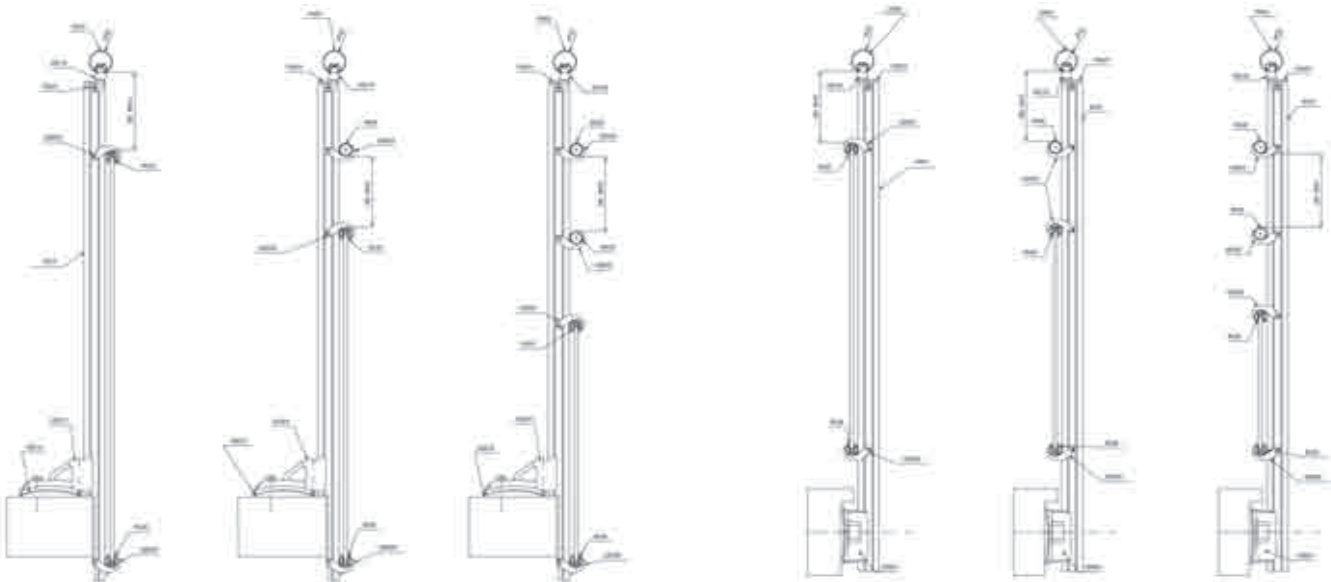
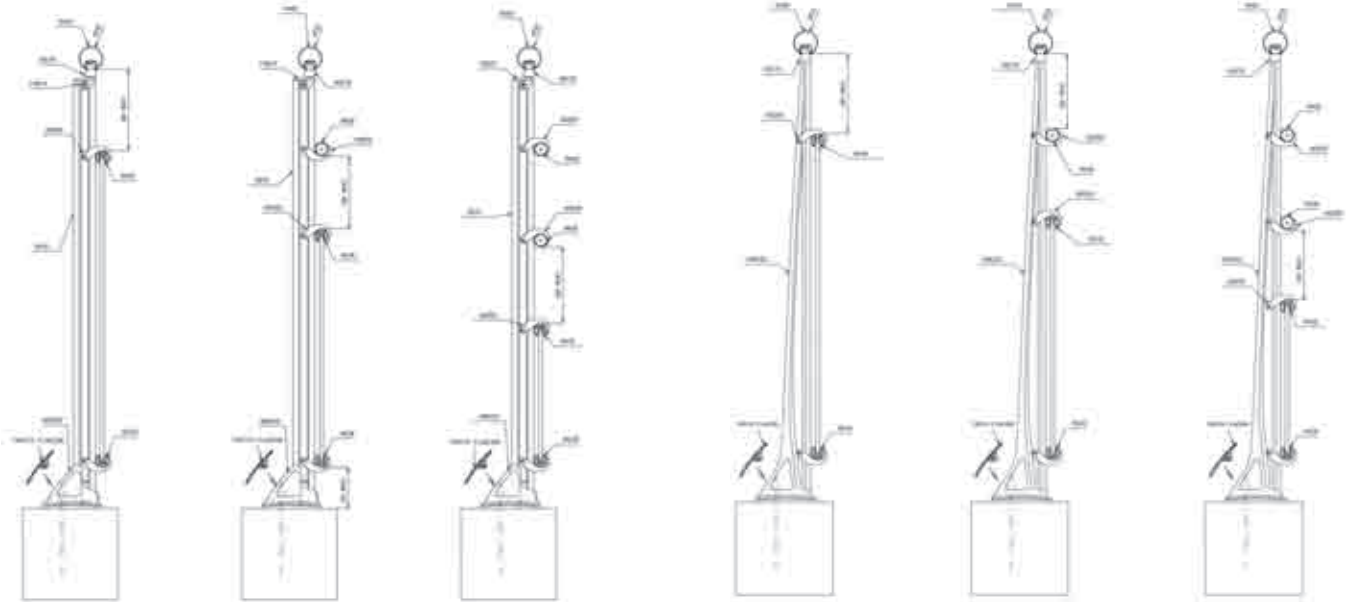

Para más información consultar catálogo específico.

## DETALLE DE BARANDILLA ANTARES

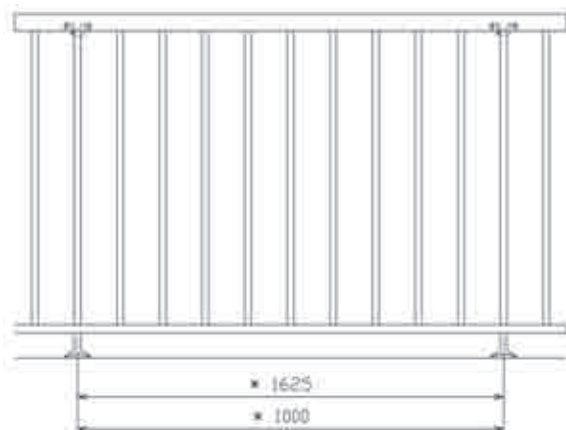

\* COTAS MÁXIMAS ENTRE PILASTRAS EN EDIFICIOS PRIVADOS / PUBLICOS

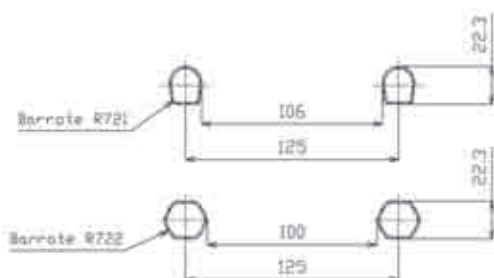

Tramo de barandilla con barrotes fijos montados sin pasamano  
Suministro en tramos de 6,5 mts

Ref. **9800910**

Tramo de 910 mm de altura

**Medidas especiales.**

Ref. **9800530**

Tramo de 530 mm de altura

Ref. **9800715**

Tramo de 715 mm de altura

Ref. **9801010**

Tramo de 1010 mm de altura

## DETALLE DE BARANDILLA RANCH

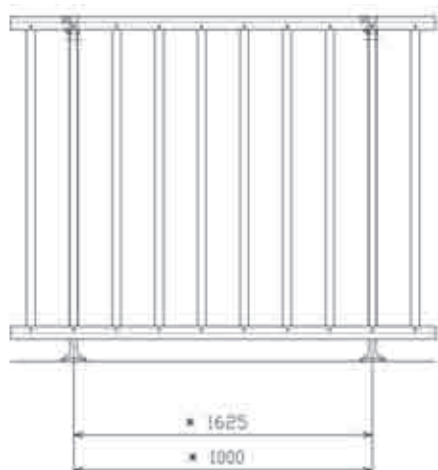

\* COTAS MÁXIMAS ENTRE PILASTRAS EN EDIFICIOS PRIVADOS / PUBLICOS

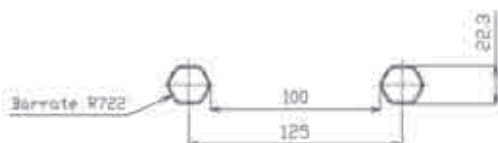

Tramo de barandilla con barrotes montados, preparada para articulación según escalera, incluido pasamano.  
Suministro en tramos de 2, 4 y 6 mts.

Ref. **9809382**

Tramo de barandilla de 2 mts

Ref. **9809384**

Tramo de barandilla de 4 mts

Ref. **9809386**

Tramo de barandilla de 6 mts



Ref. **R460**  
Pasamano de barandilla HORIZONTAL

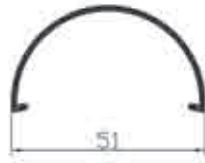

Ref. **R560**  
Pasamano de barandilla HORIZONTAL

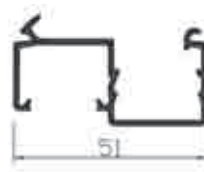

Ref. **R610**  
Base de pasamano clipado

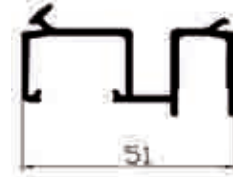

Ref. **R619**  
Base de pasamano clipado con entrada de vidrio.

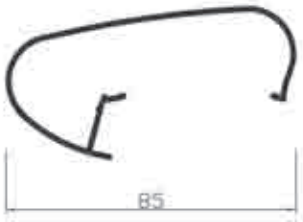

Ref. **R620**  
Pasamano de barandilla HORIZONTAL



Ref. **R630**  
Perfil para vidrio



Ref. **R660**  
Rigidizador de barandilla HORIZONTAL modelo Ariane (sobre murete)

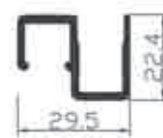

Ref. **R666**  
Perfil inferior vidrio.

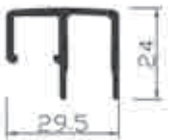

Ref. **R667**  
Perfil superior vidrio



Ref. **R678**  
Perfil remate lateral

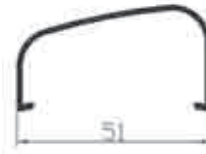



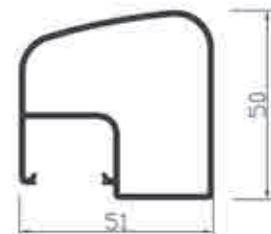

Ref. **R720**  
Pasamano de barandilla HORIZONTAL



Ref. **R740**  
Pasamano de barandilla HORIZONTAL

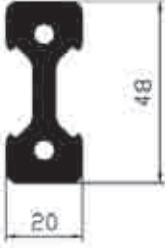
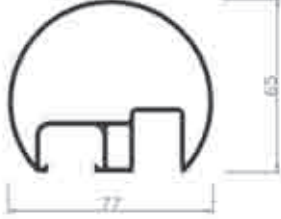

# Barandilla Horizontal





 <p>Ref. <b>R758</b> Pasamano de barandilla HORIZONTAL</p>	 <p>Ref. <b>R819</b> Rigidizador de barandilla HORIZONTAL.</p>	 <p>Ref. <b>R860</b> Pasamano de barandilla HORIZONTAL <b>*Consultar stock.</b></p>	 <p>Ref. <b>R861</b> Tapeta para perfiles R660 y R460</p>
 <p>Ref. <b>RD649</b> Perfil para Cruz de San Andres</p>	 <p>Ref. <b>RN30</b> Tubo redondo Tubo normalizado</p>		

Perfiles extrusionados en aleación 6063 (UNE - 38337)  
Estado de suministro T-5  
Tolerancias de dimensiones y espesores según norma UNE 38066

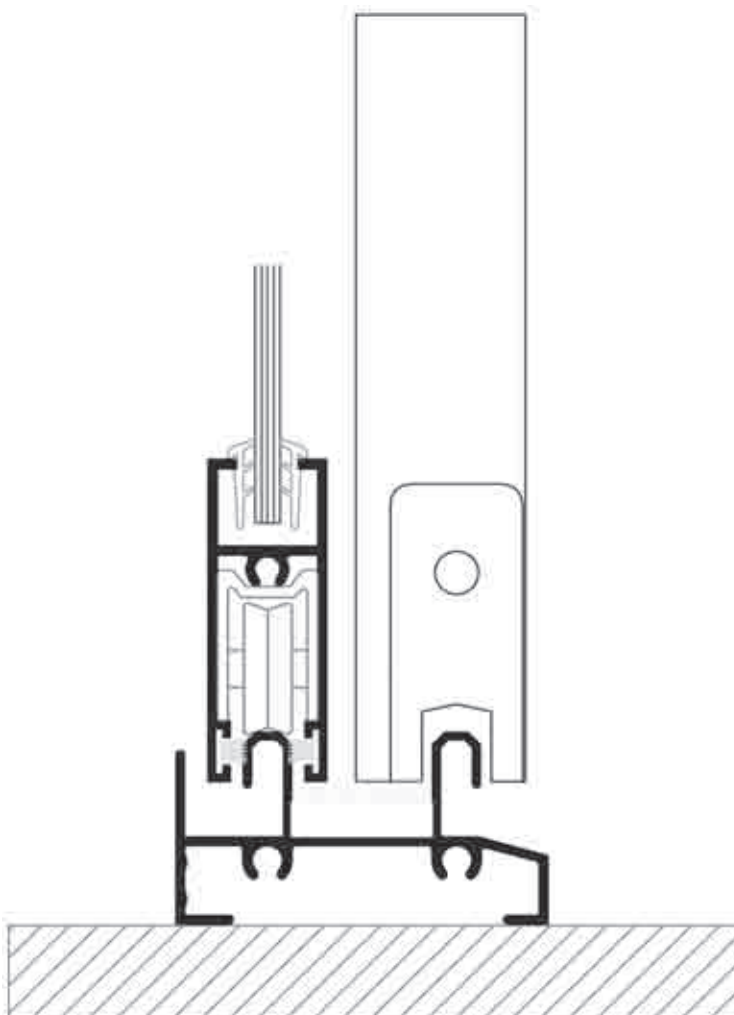
Los ensayos son según los especificados por nuestro extrusionador, el ensayo real se deberá realizar por el instalador

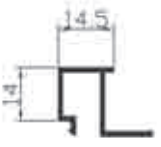
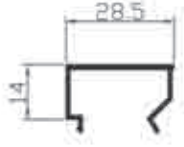
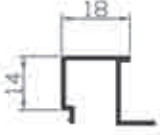
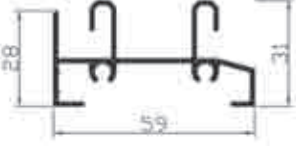
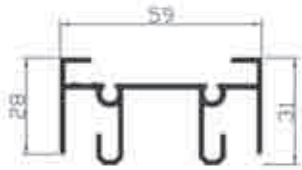
Permeabilidad al aire	Clase A-2
Estanqueidad al agua	Clase E-2
Resistencia al viento	Clase V-2

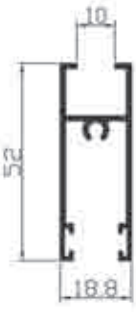
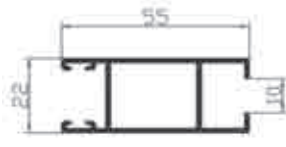

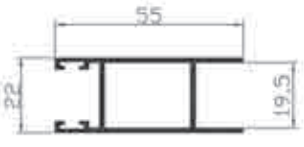
 <p><b>Ref 3911</b> Junquillo de 14,5 mm para fijos * <b>Consultar stock</b></p>	 <p><b>Ref 4343</b> Junquillo de 28,5 mm para fijos * <b>Consultar stock</b></p>	 <p><b>Ref 11537</b> Junquillo de 18 mm para fijos * <b>Consultar stock</b></p>	 <p><b>Ref 62002</b> Marco inferior corredera</p>
 <p><b>Ref 62003</b> Marco superior corredera</p>	 <p><b>Ref 62004</b> Marco lateral corredera</p>	 <p><b>Ref 62012</b> Perfil de cruce para vidrio normal</p>	 <p><b>Ref 62013</b> Hoja casaca para vidrio normal</p>
 <p><b>Ref 62014</b> Hoja lateral para vidrio normal</p>	 <p><b>Ref 62015</b> Perfil de cruce para vidrio cámara</p>	 <p><b>Ref 62016</b> Hoja casaca para vidrio cámara</p>	 <p><b>Ref 62017</b> Hoja lateral para vidrio cámara</p>

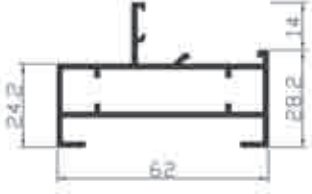

Ref. **62018**  
Perfil para fijos  
**\*Consultar stock**



Ref. **62021**  
Perfil para fijar ángulos a marcos



Ref. **62022**  
Hoja para fijar ángulos a marcos

Perfiles extrusionados en aleación 6063 (UNE - 38337)  
Estado de suministro T-5  
Tolerancias de dimensiones y espesores según norma UNE 38066

Los ensayos han sido realizados en Cidemco (Guipúzcoa), en una ventana de dos hojas de medidas 1200 x 1200 mm. con nº de certificado 11812 y con los siguientes resultados:

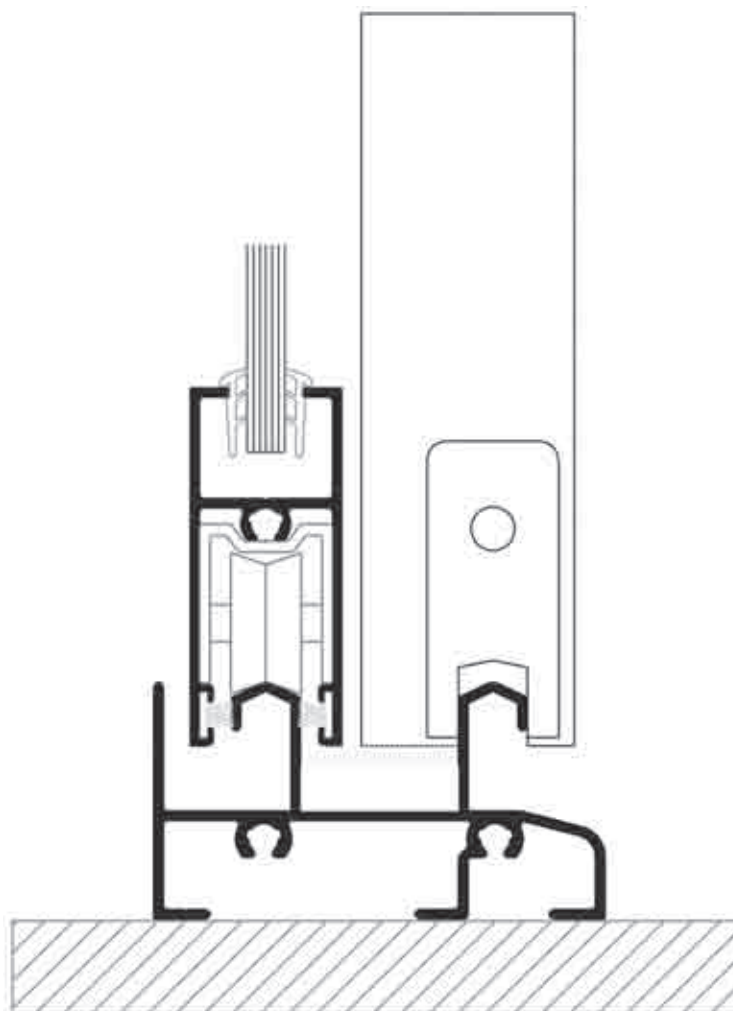

Permeabilidad al aire	UNE EN 1026:2000	Clase 2
Estanqueidad al agua	UNE EN 1027:2000	Clase 3A
Resistencia al viento	UNE EN 12211:2000	Clase C4

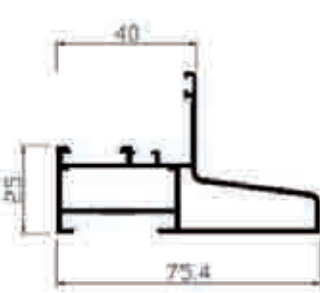
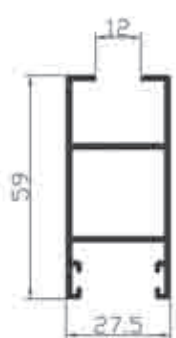
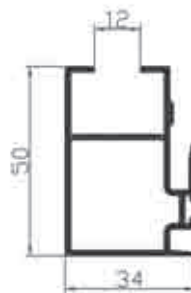
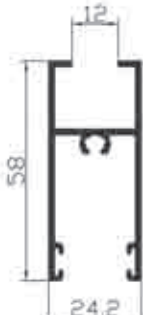
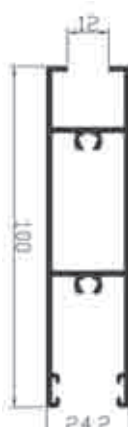
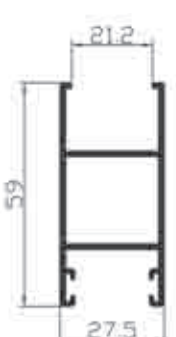
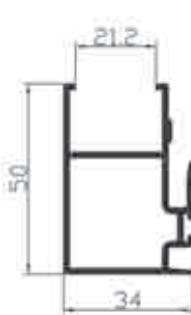

 <p>Ref: <b>71021*</b> Marco fijo</p>	 <p>Ref: <b>72015</b> Hoja lateral para vidrio normal.</p>	 <p>Ref: <b>72016</b> Hoja cruce para vidrio normal.</p>	 <p>Ref: <b>72017</b> Hoja casaca para vidrio normal.</p>
 <p>Ref: <b>72018</b> Hoja zócalo para vidrio normal. <b>*Consultar stock</b></p>	 <p>Ref: <b>72019</b> Hoja lateral para vidrio cámara</p>	 <p>Ref: <b>72020</b> Hoja cruce para vidrio cámara</p>	

**\* Sobre el marco 71021 son compatibles los travesaños de la serie Euro 40 y los junquillos de cámara europea.**

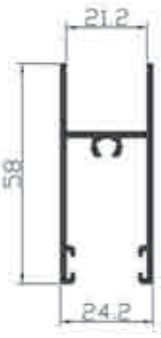
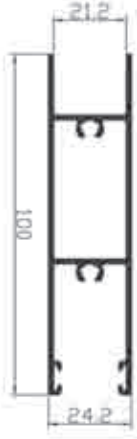
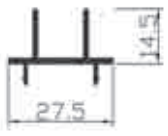
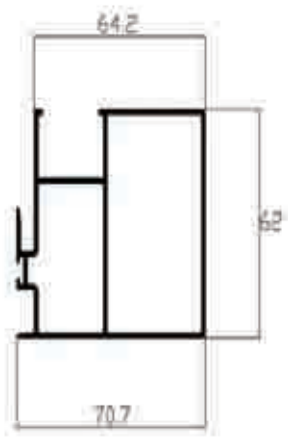
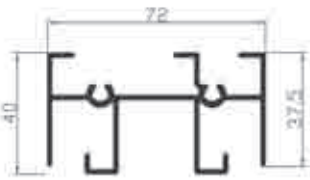
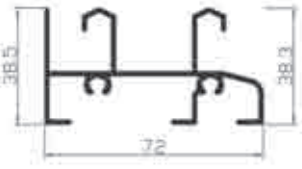

 <p>Ref. <b>72021</b> Hoja casaca para vidrio cámara</p>	 <p>Ref. <b>72022</b> Hoja zócalo para vidrio cámara</p>	 <p>Ref. <b>72023</b> Perfil acoplamiento cuatro hojas</p>	 <p>Ref. <b>72024</b> Hoja cruce refuerzo</p>
 <p>Ref. <b>72095</b> Marco superior</p>	 <p>Ref. <b>72096</b> Hoja inferior</p>	 <p>Ref. <b>72097</b> Marco lateral</p>	

Perfiles extrusionados en aleación 6063 (UNE - 38337)  
Estado de suministro T-5  
Tolerancias de dimensiones y espesores según norma UNE 38066

Los ensayos han sido realizados en Cidemco (Guipúzcoa), en una ventana de dos hojas de medidas 1200 x 1200 mm. con nº de certificado 11813 y con los siguientes resultados:

Permeabilidad al aire	UNE EN 1026:2000	Clase 3
Estanqueidad al agua	UNE EN 1027:2000	Clase 3A
Resistencia al viento	UNE EN 12211:2000	Clase C5

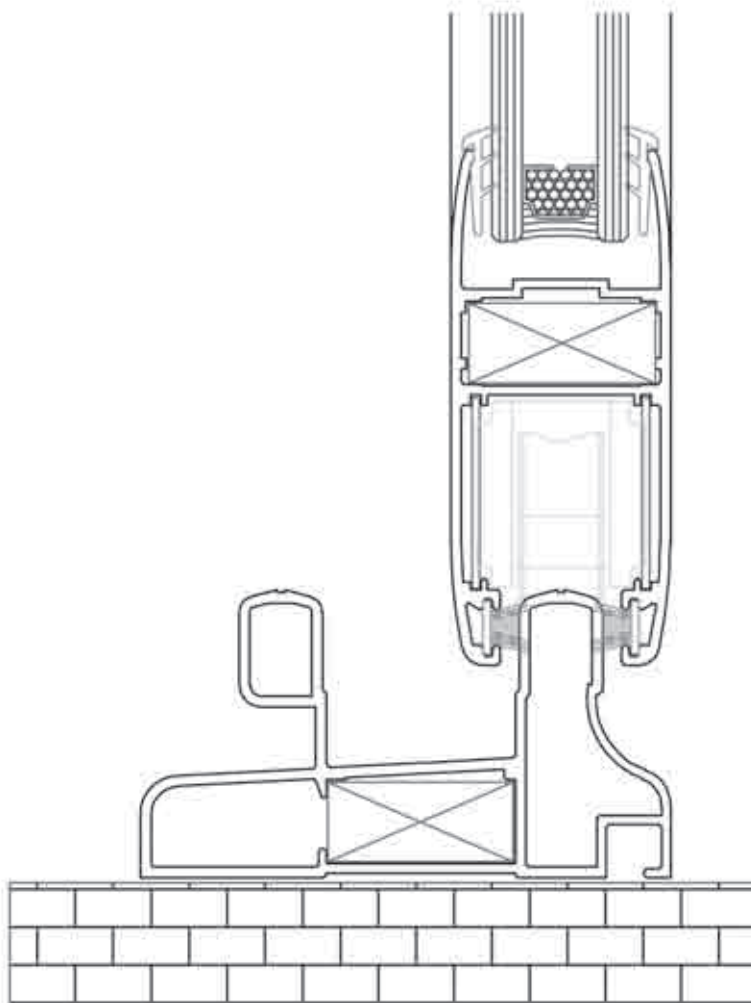

# Corredera Samblex P70CO

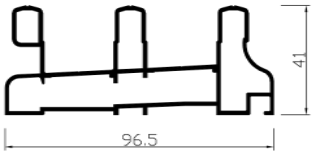
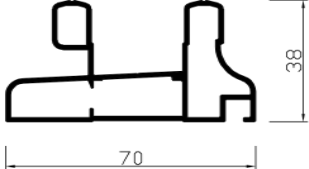
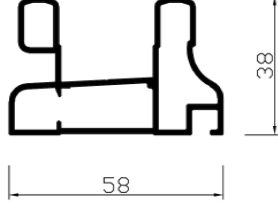
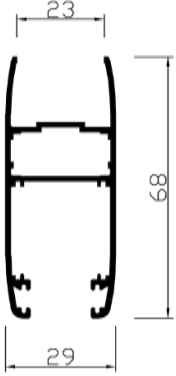
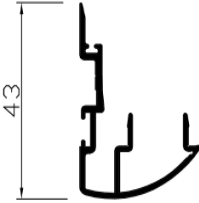
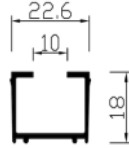
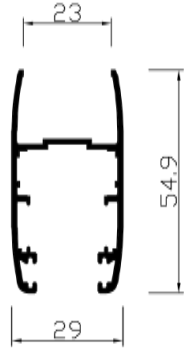
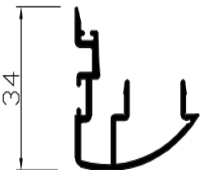
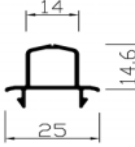
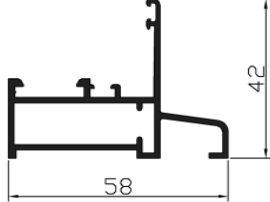
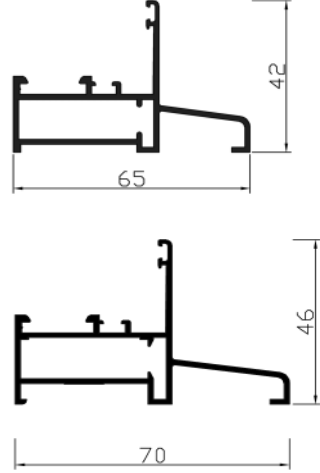
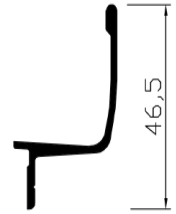

 <p>Ref. <b>70000</b> Marco perimetral 3 carriles</p>	 <p>Ref. <b>70001</b> Marco perimetral 70 mm.</p>	 <p>Ref. <b>70002</b> Marco perimetral 58 mm.</p>	 <p>Ref. <b>70003</b> Hoja perimetral.</p>
 <p>Ref. <b>70004</b> Tapeta cruce para hoja 70003.</p>	 <p>Ref. <b>70006</b> Reductor vidrio.</p>	 <p>Ref. <b>70013</b> Hoja pequeña perimetral.</p>	 <p>Ref. <b>70014</b> Tapeta cruce hoja 70013.</p>
 <p>Ref. <b>70016</b> Perfil 4 hojas.</p>	 <p>Ref. <b>65029</b> Marco fijos 58 mm.</p>	 <p>Ref. <b>65030</b> - Marco para fijos 65 mm. <b>70009</b> - Marco para fijos 70 mm.</p>	 <p>Ref. <b>21044</b> Perfil goterón. <b>*Consultar stock</b></p>

Perfiles extrusionados en aleación 6063 (UNE - 38337)  
Estado de suministro T-5  
Tolerancias de dimensiones y espesores según norma UNE 38066

Los ensayos han sido realizados en Cidemco (Guipúzcoa), en una ventana de dos hojas de medidas 1400 x 1200 mm. con nº de certificado 17380 y con los siguientes resultados:

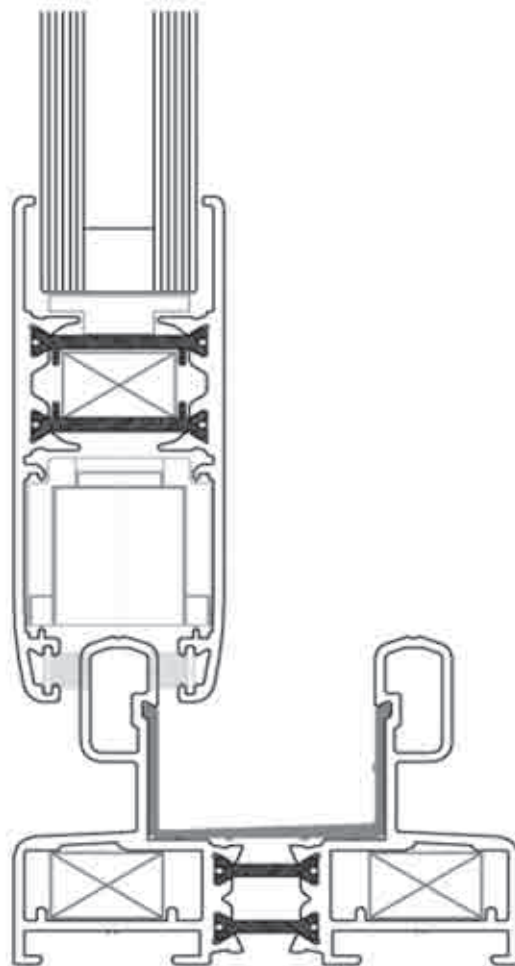
Permeabilidad al aire	(UNE EN 1026:2000)	Clase 2
Estanqueidad al agua	(UNE EN 1027:2000)	Clase 4A
Resistencia al viento	(UNE EN 12211:2000)	Clase C5
Transmitancia térmica	(UNE EN 10077-1)	$U_w=3,1(W/m^2 K)$ CTE - 2,8(W/m <sup>2</sup> K)

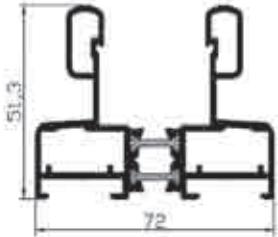
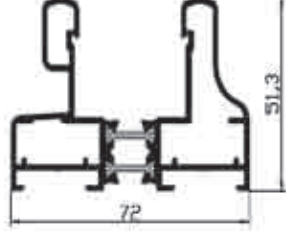
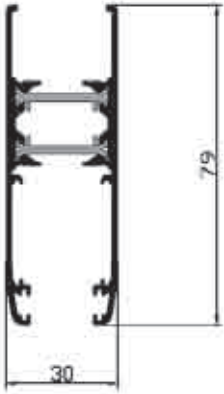
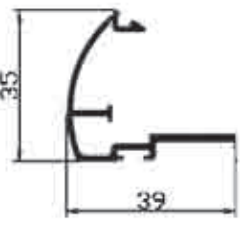
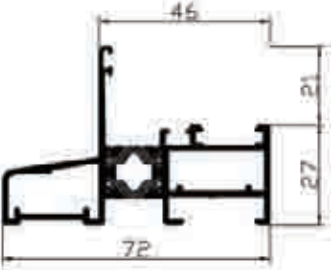
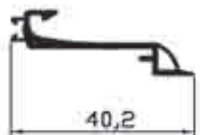

 <p>Ref <b>74000</b> Marco perimetral simetrico 2 carriles</p>	 <p>Ref <b>74001</b> Marco perimetral asimetrico 2 carriles</p>	 <p>Ref <b>74002</b> Hoja perimetral</p>	 <p>Ref <b>74003</b> Tapeta cruce para hoja 74002.</p>
 <p>Ref <b>74004</b> Marco perimetral para fijos</p>	 <p>Ref <b>74050</b> Poliamida</p>	 <p>Ref <b>74051</b> Poliamida</p>	 <p>Ref <b>21044</b> Perfil goterón. <b>*Consultar stock</b></p>

**\* Sobre el marco 74004 son compatibles todos los junquillos de cámara europea**



Perfiles extrusionados en aleación 6060 (EN 573-3)  
Estado de suministro T-5 (EN 755-2)  
Tolerancias de dimensiones y espesores según norma EN 755-9

Los ensayos han sido realizados en Cidemco (Guipúzcoa), en una ventana de dos hojas de medidas 1200 x 1200 mm. con el nº de certificado 13558 y con los siguientes resultados:

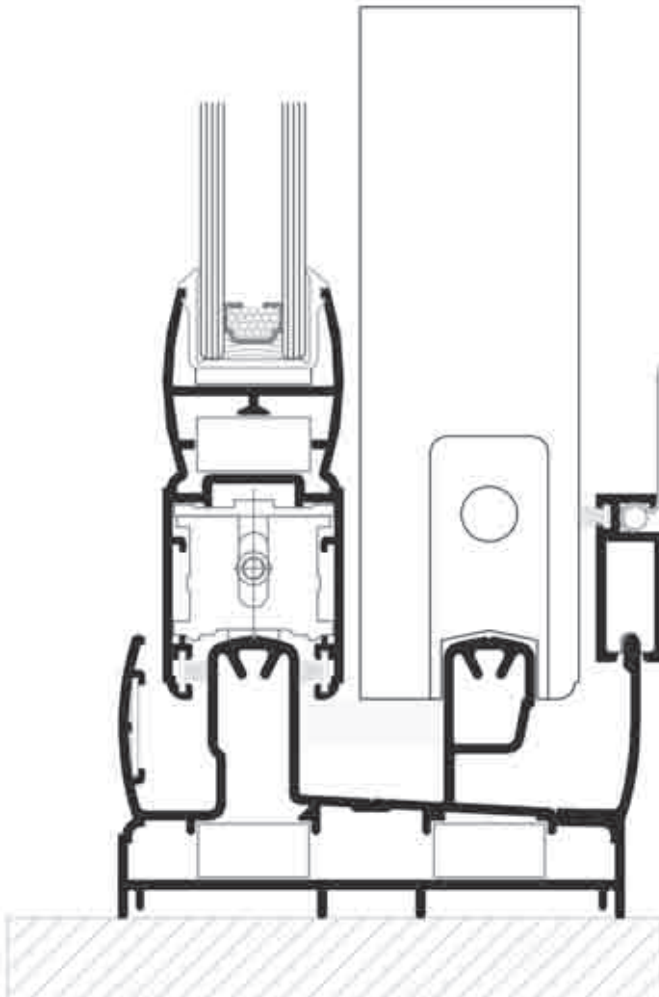
Permeabilidad al aire	(UNE EN 1026:2000)	Clase 3
Estanqueidad al agua	(UNE EN 1027:2000)	Clase 5A
Resistencia al viento	(UNE EN 12211:2000)	Clase C5



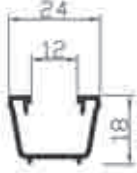
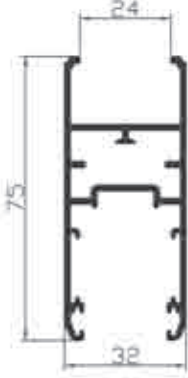
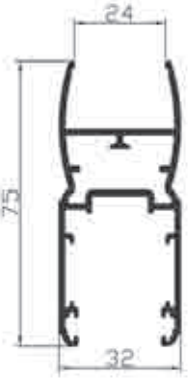
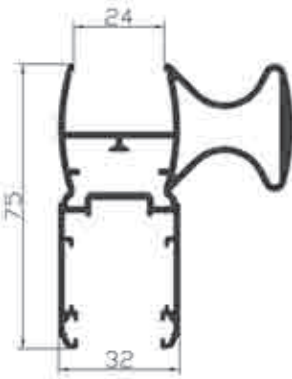
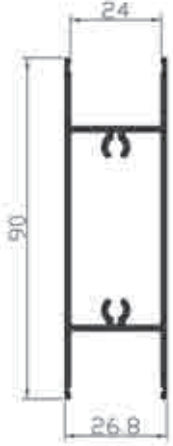
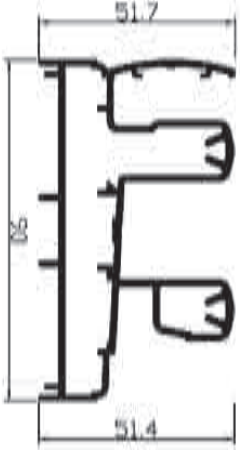

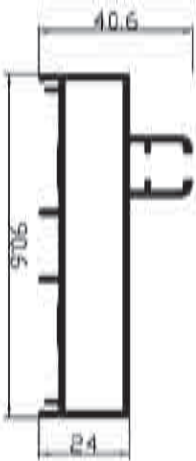
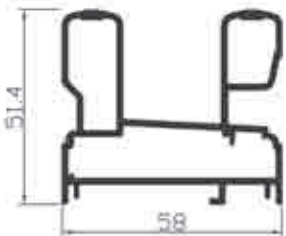
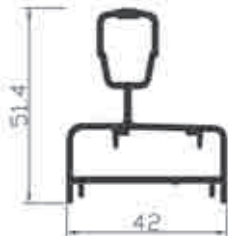
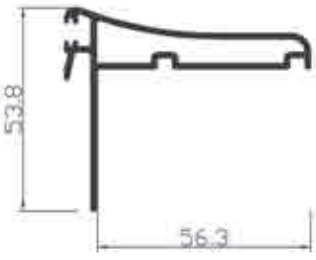
 <p><b>Ref. 21019</b> Reductor galce vidrio</p>	 <p><b>Ref. 21033</b> Hoja recta</p>	 <p><b>Ref. 21034</b> Hoja curva</p>	 <p><b>Ref. 21035</b> Hoja reforzada</p>
 <p><b>Ref. 21038</b> Franja vidrio directo</p>	 <p><b>Ref. 21041</b> Marco 90 mm corte perimetral o corte recto</p>	 <p><b>Ref. 21043</b> Perfil tapajuntas</p>	 <p><b>Ref. 21044</b> Perfil exterior mosquitera <b>*Consultar stock</b></p>
 <p><b>Ref. 21045</b> Marco lateral 90 mm</p>	 <p><b>Ref. 21048</b> Marco perimetral</p>	 <p><b>Ref. 21049</b> Marco monorrail</p>	 <p><b>Ref. 21054</b> Perfil cruce pared monorrail</p>

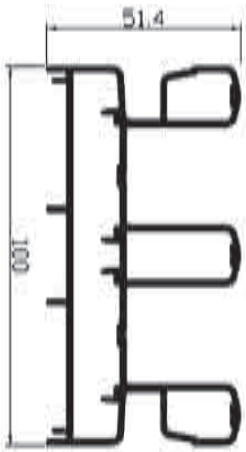

Ref. **21055**  
Marco tres carriles perimetral

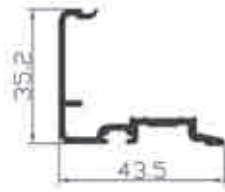

Ref. **21058**  
Perfil cruce

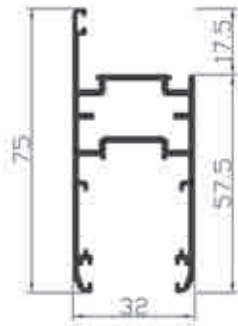

Ref. **21059**  
Hoja ajunquillada



Ref. **21060**  
Perfil de junquillo

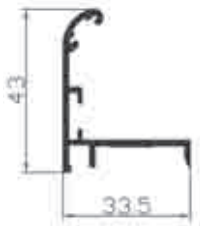

Ref. **21350**  
Angulo para registro



Ref. **21351**  
Base registro



Ref. **21984**  
Perfil recogida de aguas

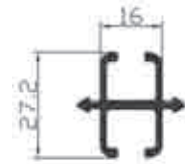

Ref. **21985**  
Perfil acoplamiento 4 hojas

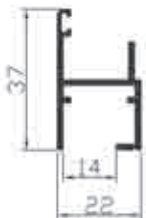

Ref. **24444**  
Perfil cajón registro





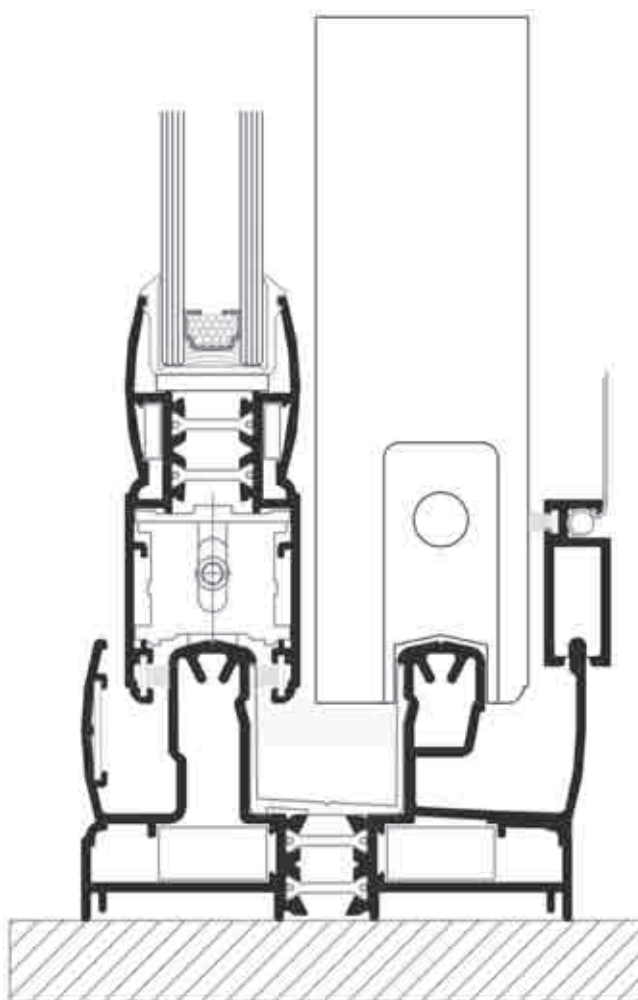

Perfiles extrusionados en aleación 6060 (EN 573-3)  
Estado de suministro T-5 (EN 755-2)  
Tolerancias de dimensiones y espesores según norma EN 755-9

Los ensayos han sido realizados en ISTDIL (Roma), en una ventana de dos hojas de medidas 1600 x 1400 mm., con los siguientes resultados:

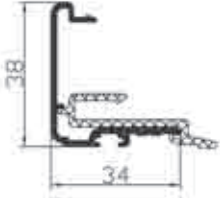
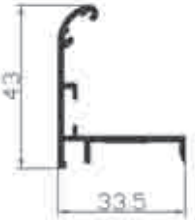

Permeabilidad al aire	UNE EN 1026:2000	Clase 4
Estanqueidad al agua	UNE EN 1027:2000	Clase 9
Resistencia al viento	UNE EN 12211:2000	Clase C5
Transmitancia térmica	UNE EN 10077:1	$U_w=3,08U_w/m^2 K$

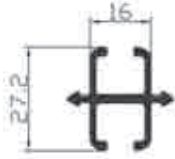
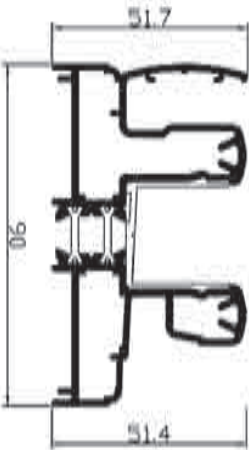
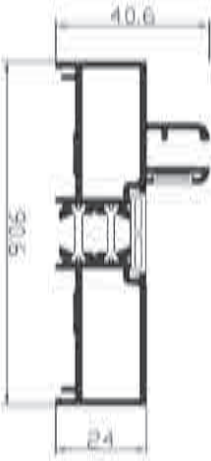

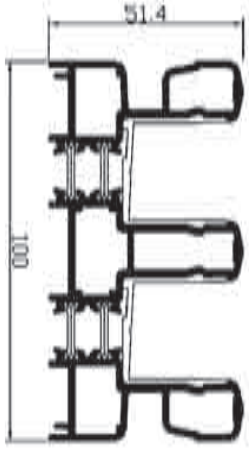
Atención, existe la posibilidad de realizar acabados en bicolor,  
**\*consultar**

 <p>Ref. <b>21043</b> Perfil tapajuntas</p>	 <p>Ref. <b>21044</b> Perfil exterior mosquitera <b>*Consultar stock</b></p>	 <p>Ref. <b>21060</b> Perfil de junquillo</p>	 <p>Ref. <b>21068</b> Perfil cruce</p>
 <p>Ref. <b>21350</b> Angulo para registro</p>	 <p>Ref. <b>21351</b> Base registro</p>	 <p>Ref. <b>21984</b> Perfil recogida de aguas</p>	 <p>Ref. <b>21985</b> Perfil acoplamiento 4 hojas</p>
 <p>Ref. <b>22401</b> Marco 90 mm corte perimetral o corte recto</p>	 <p>Ref. <b>22404</b> Marco lateral 90 mm</p>	 <p>Ref. <b>22406*</b> Marco perimetral</p>	 <p>Ref. <b>22408</b> Marco tres carriles perimetral</p>

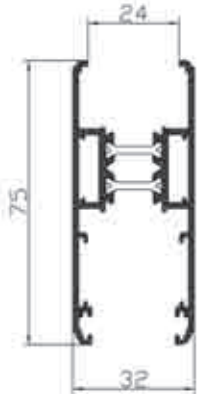
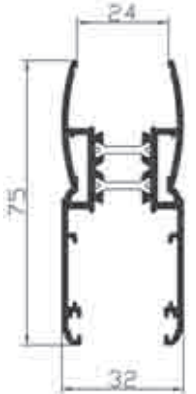
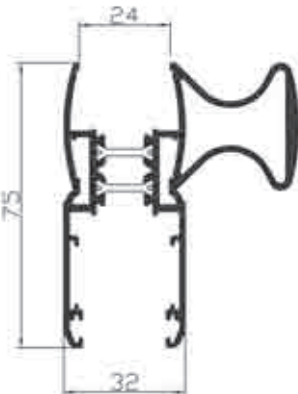
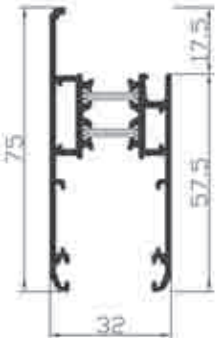
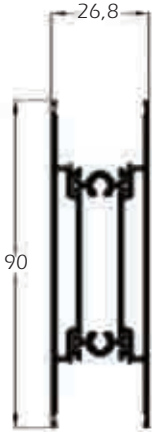
# Corredera Abithal Runner tt

 <p>Ref. <b>22410*</b> Hoja recta</p>	 <p>Ref. <b>22411</b> Hoja curva</p>	 <p>Ref. <b>22412</b> Hoja reforzada</p>	 <p>Ref. <b>22413</b> Hoja ajunquillada</p>
 <p>Ref. <b>22420</b> Franja de vidrio directo * Consultar stock</p>	 <p>Ref. <b>24444</b> Perfil cajón registro</p>		

Perfiles extrusionados en aleación 6060 (EN 573-3)  
Estado de suministro T-5 (EN 755-2)  
Tolerancias de dimensiones y espesores según norma EN 755-9

Los ensayos estan pendientes de realizarse.

Permeabilidad al aire	Pendiente de ensayo
Estanqueidad al agua	Pendiente de ensayo
Resistencia al viento	Pendiente de ensayo
Transmitancia térmica	$U_w = 2,13 \text{ W/m K}^2$

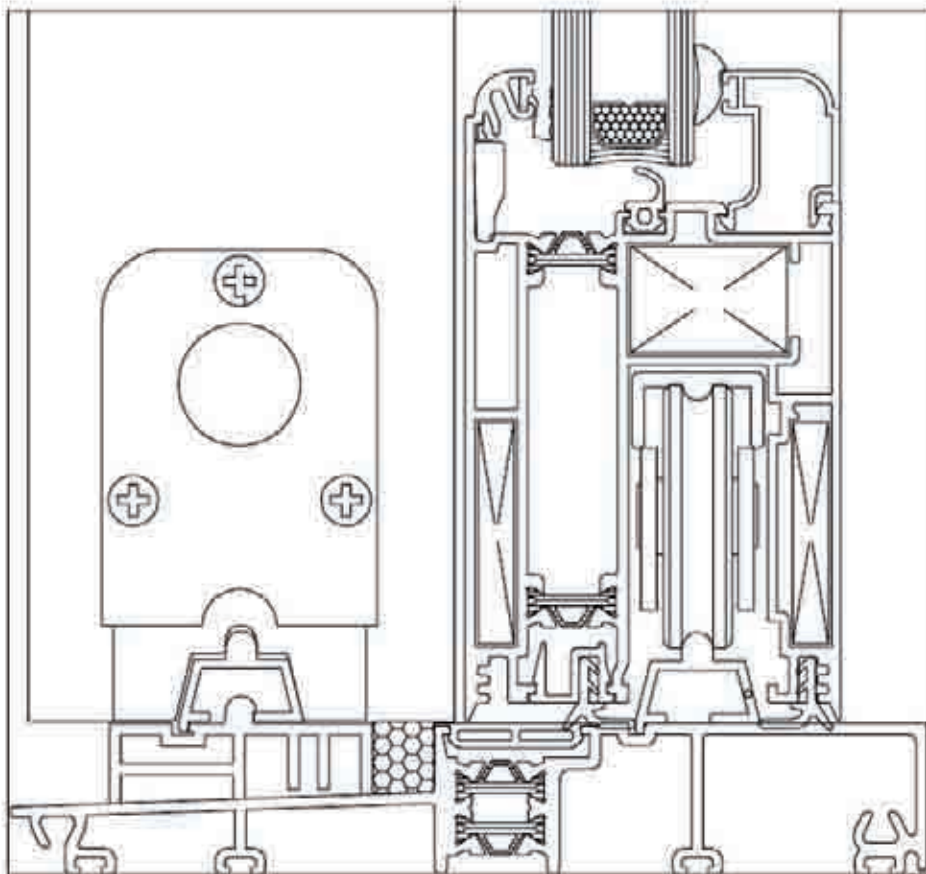



# Corredera Euro Runner 250tt







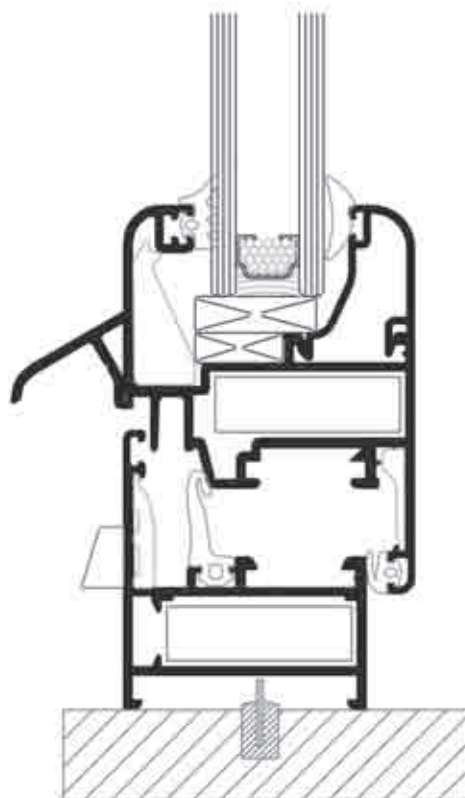

<p>Ref. <b>22424</b> Marco inferior</p>	<p>Ref. <b>22425</b> Marco lateral</p>	<p>Ref. <b>22426</b> Hoja elevable</p>	<p>Ref. <b>21960</b> Perfil cierre marco lateral</p>
<p>Ref. <b>21961</b> Tapeta lateral marco</p>	<p>Ref. <b>21962</b> Guia superior</p>	<p>Ref. <b>21963</b> Tapeta cruce</p>	<p>Ref. <b>40BNXX20*</b> Guia inferior Longitud 6,5 mts</p>
<p>Ref. <b>40BNYY20*</b> Base guía inferior Longitud 6,5 mts</p>	<p>Ref. <b>N22315*</b> Guia inferior acoplamiento Longitud 6,5 mts</p>	<p>Ref. <b>N22316*</b> Base acoplamiento Longitud 6,5 mts</p>	

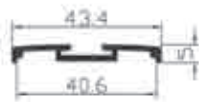
Perfiles extrusionados en aleación 6060 (EN 573-3)  
Estado de suministro T-5 (EN 755-2)  
Tolerancias de dimensiones y espesores según norma EN 755-9

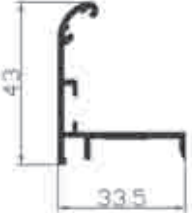
Los ensayos han sido realizados en ISTEDIL (Roma), en una ventana de dos hojas de medidas 1200 x 1400 mm., con los siguientes resultados:

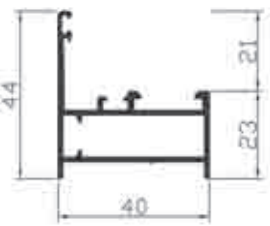
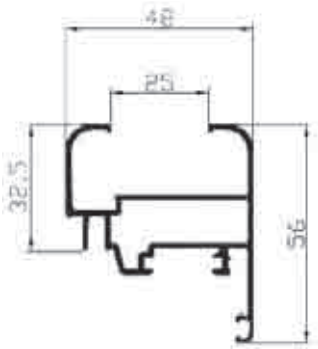
Permeabilidad al aire	Clase A-3
Estanqueidad al agua	Clase E-3
Resistencia al viento	Clase V-2a

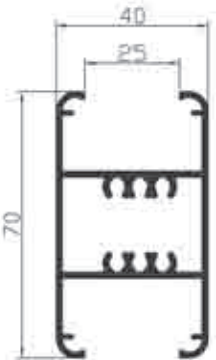
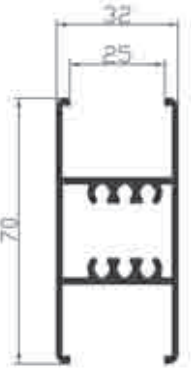
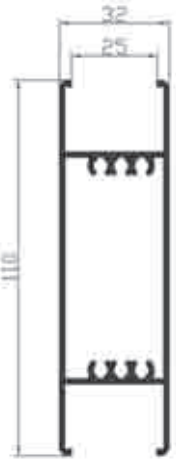
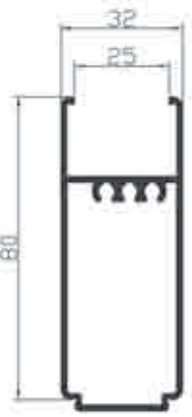

 <p>Ref <b>482</b> Perfil tapeta vaivén</p>	 <p>Ref <b>20788</b> Pletina accionamiento cremoña.</p>	 <p>Ref <b>21350</b> Angulo para registro.</p>	 <p>Ref <b>21351</b> Base registro.</p>
 <p>Ref <b>21362</b> Marco ventana ligero</p>	 <p>Ref <b>21363</b> Hoja ventana ligera</p>	 <p>Ref <b>21579</b> Perfil vierteaguas</p>	 <p>Ref <b>24406</b> Travesaño vidrio directo</p>
 <p>Ref <b>24426</b> Travesaño vidrio directo</p>	 <p>Ref <b>24427</b> Travesaño vidrio directo</p>	 <p>Ref <b>24428</b> Suplemento zócalo vidrio directo.</p>	 <p>Ref <b>24444</b> Perfil cajón registro.</p>

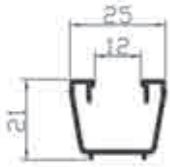

Ref. **24446**  
Reductor galce vidrio

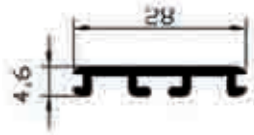

Ref. **24455**  
Tapeta remate

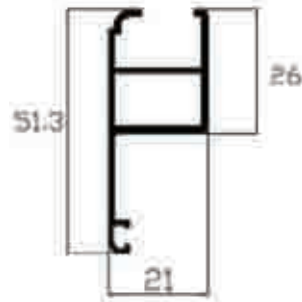

Ref. **24476**  
Hoja porticon

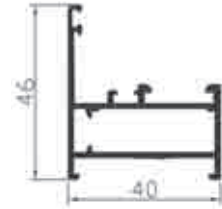

Ref. **27000**  
Marco ventana.

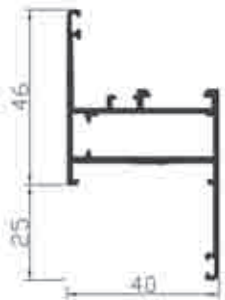

Ref. **27001**  
Marco ventana con tapajuntas.

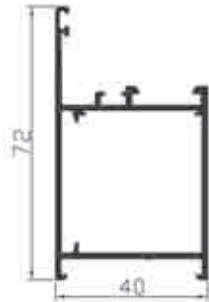

Ref. **27002**  
Marco puerta sin tapajuntas

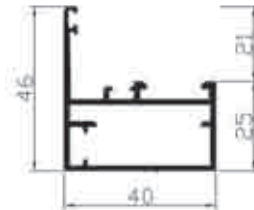

Ref. **27003**  
Marco ventana plano.

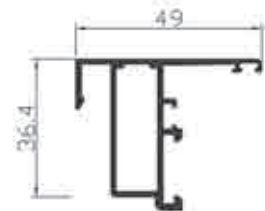

Ref. **27008**  
Perfil inversor marco

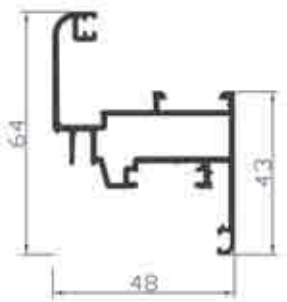

Ref. **27030**  
Hoja ajunquillada

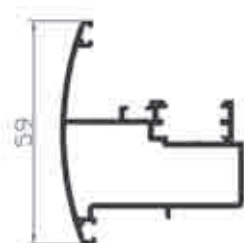

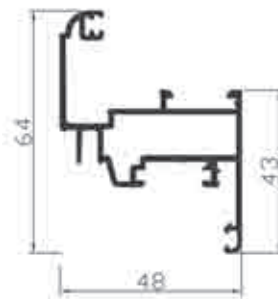

Ref. **27031**  
Perfil acoplamiento central

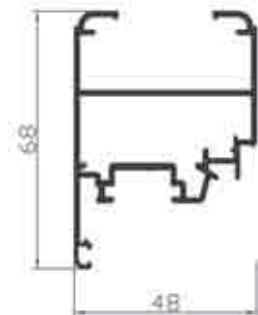

Ref. **27032**  
Hoja ajunquillada

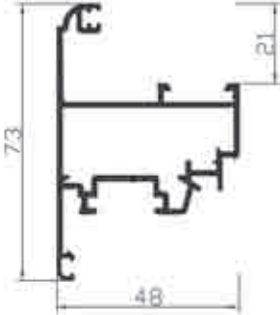
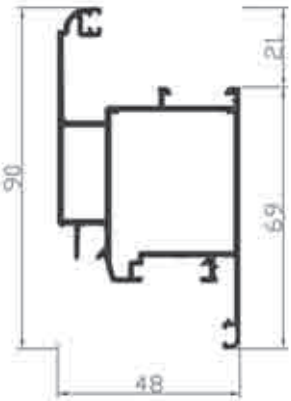
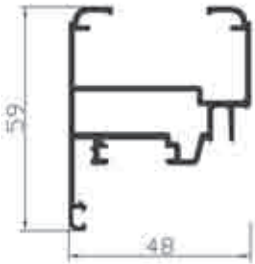
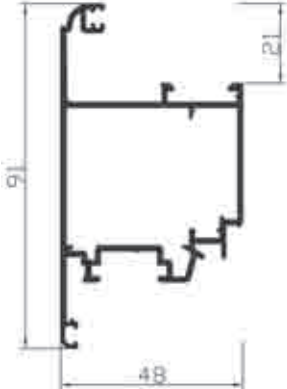
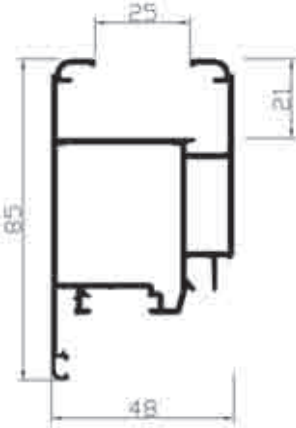
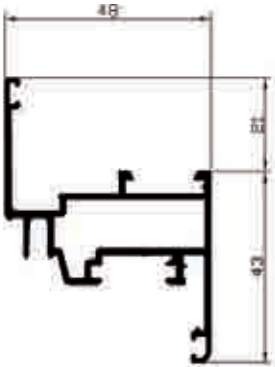
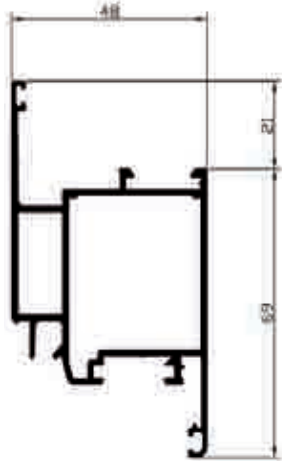
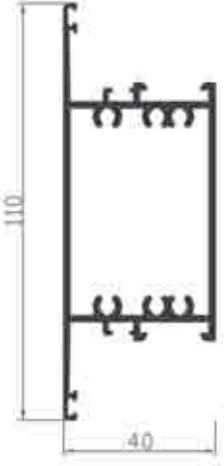

Ref. **27033**  
Hoja vidrio directo

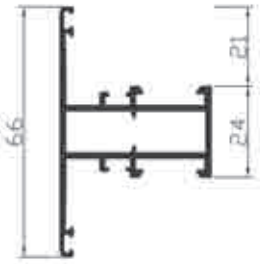
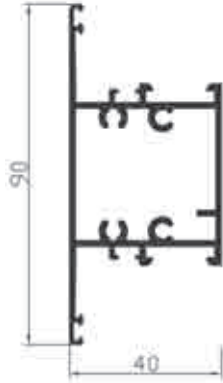
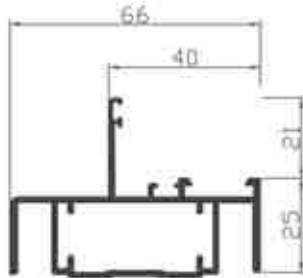
 <p><b>Ref. 27034</b> Hoja apertura exterior</p>	 <p><b>Ref. 27035</b> Hoja balconera ajunquillada</p>	 <p><b>Ref. 27036</b> Hoja vidrio directo</p>	 <p><b>Ref. 27038</b> Hoja balconera apertura exterior</p>
 <p><b>Ref. 27040</b> Hoja balconera vidrio directo</p>	 <p><b>Ref. 27042</b> Hoja ventana</p>	 <p><b>Ref. 27046</b> Hoja puerta</p>	 <p><b>Ref. 27061</b> Travesaño / franja</p>
 <p><b>Ref. 27062</b> Travesaño/franja</p>	 <p><b>Ref. 27063</b> Travesaño</p>	 <p><b>Ref. 27064</b> Travesaño</p>	 <p><b>Ref. 27066</b> Semi-rigidizador</p>

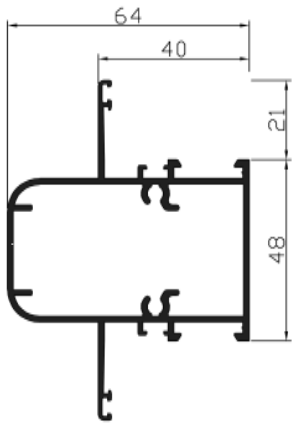

Ref. **27067**  
Rigidizador

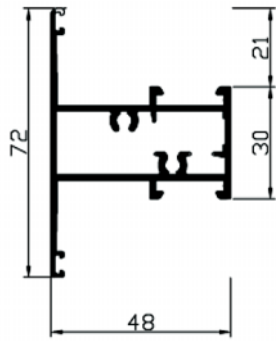

Ref. **27073**  
Travesaño

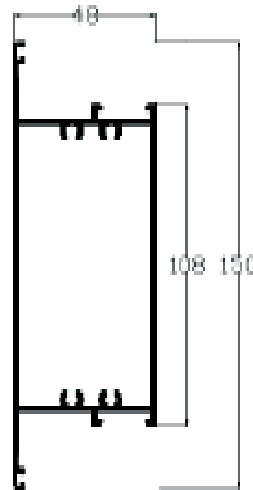

Ref. **27074**  
Zócalo

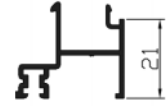

Ref. **27528**  
Remate inferior franja/zócalo

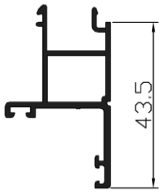

Ref. **27531**  
Remate inferior franja/zócalo

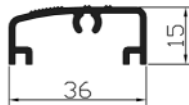

Ref. **27530**  
Remate suelo

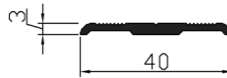

Ref. **27994**  
Remate suelo

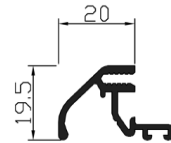

Ref. **27532**  
Perfil vierteaguas para zócalo

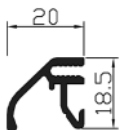

Ref. **27537**  
Perfil vierteaguas para zócalo

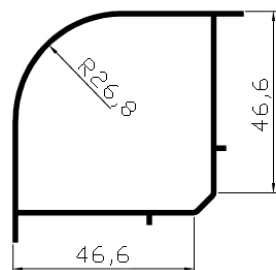

Ref. **26192**  
Perfil cantonero 90°

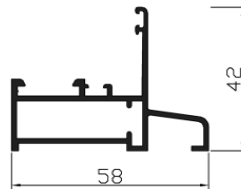

Ref. **65029**  
Perfil para fijos compatibles con corredera P70.

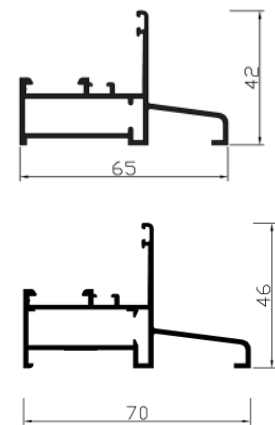

Ref. **65030 - 70009**  
Perfil para fijos compatibles con corredera P70

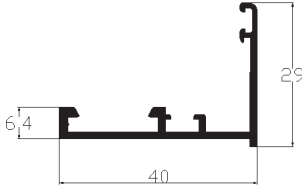
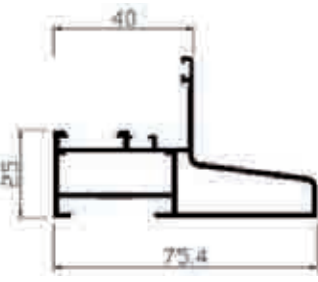
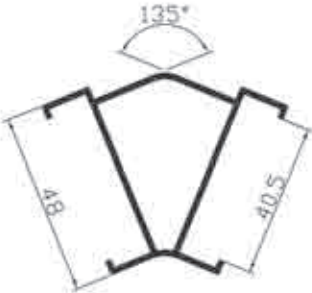
 <p>6,4 40 29</p> <p>Ref. <b>70010</b> Perfil tapeta</p>	 <p>40 25,5 75,4</p> <p>Ref. <b>71021</b> Marco fijo compatible con corredera S-72</p>	 <p>135° 48 40,5</p> <p>Ref. <b>8273</b> Perfil esquinero 135°</p>	
---	---	--	--





Perfiles extrusionados en aleación 6060 (EN 573-3)  
Estado de suministro T-5 (EN 755-2)  
Tolerancias de dimensiones y espesores según norma EN 755-9

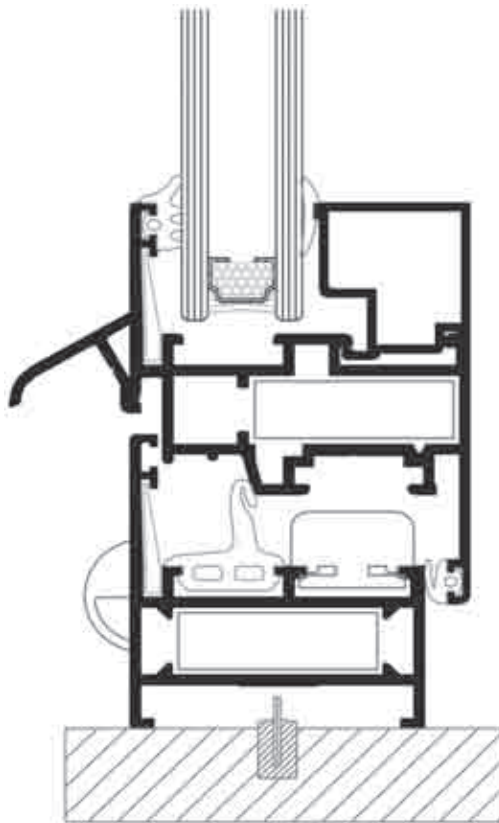

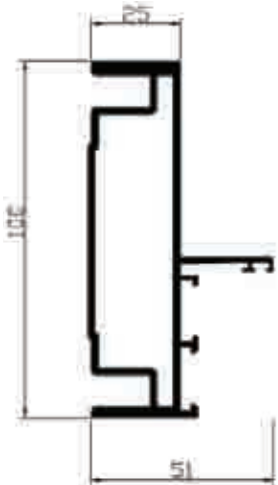
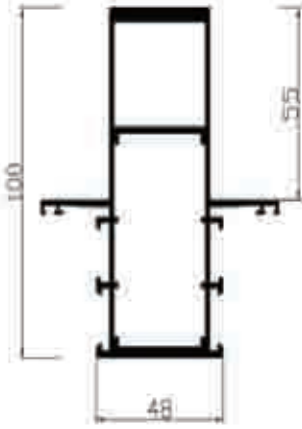
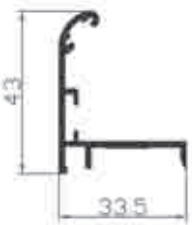

Los ensayos han sido realizados en ISTDIL (Roma), en una ventana de dos hojas de medidas 1300 x 1300 mm., con los siguientes resultados:

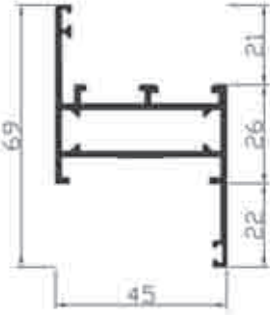
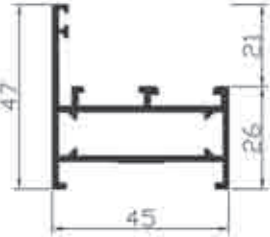
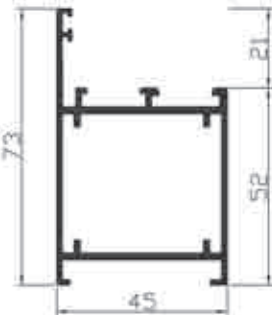
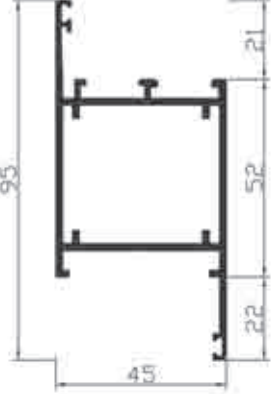
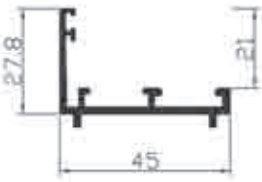
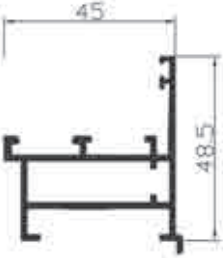
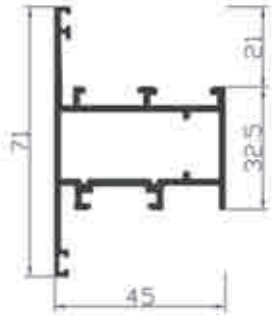



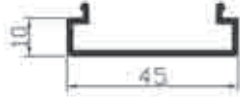

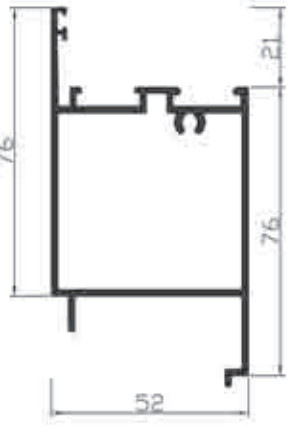
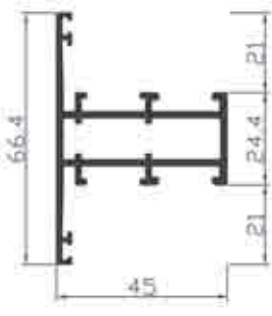
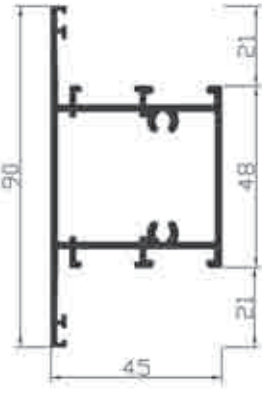
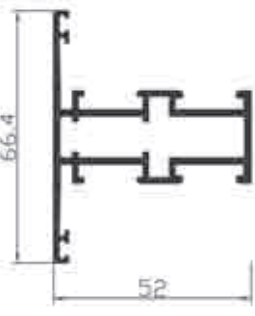
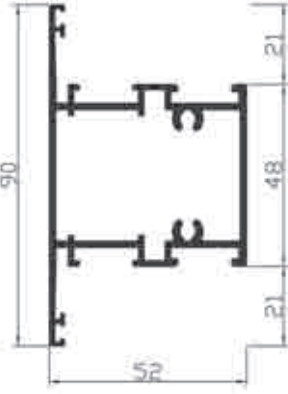
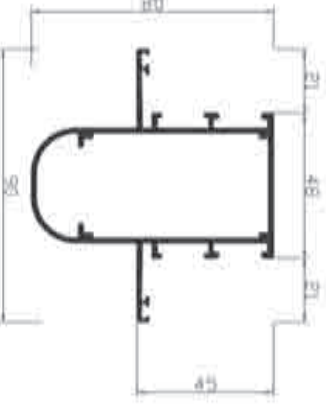
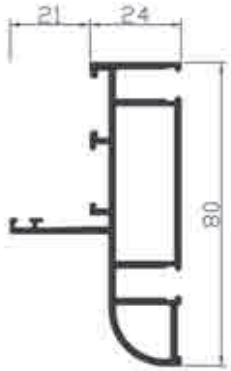
Permeabilidad al aire	Clase A-3
Estanqueidad al agua	Clase E-4
Resistencia al viento	Clase V-3



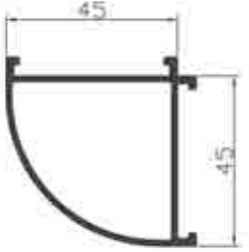

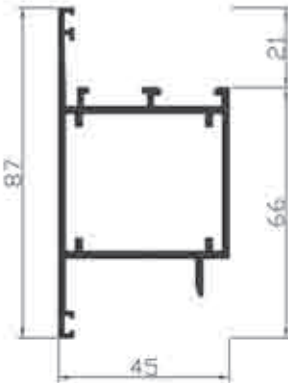
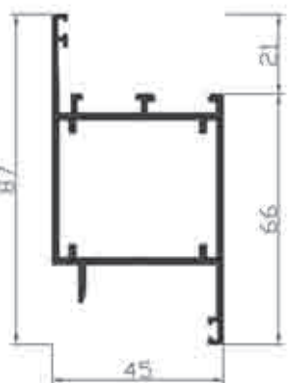
 <p>Ref. <b>11732</b> Semi Rigidizador</p>	 <p>Ref. <b>11733</b> Rigidizador</p>	 <p>Ref. <b>21350</b> Angulo para registro</p>	 <p>Ref. <b>21351</b> Base registro</p>
 <p>Ref. <b>21501</b> Marco ventana con tapajuntas</p>	 <p>Ref. <b>21503</b> Marco ventana</p>	 <p>Ref. <b>21507</b> Marco puerta</p>	 <p>Ref. <b>21508</b> Marco puerta con tapajuntas</p>
 <p>Ref. <b>21522</b> Tapeta marco</p>	 <p>Ref. <b>21523</b> Inversor marco</p>	 <p>Ref. <b>21524</b> Hoja ventana apertura exterior</p>	 <p>Ref. <b>21532</b> Franja</p>

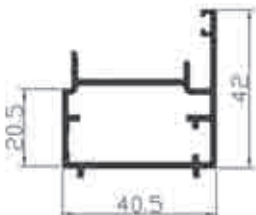
 <p>Ref. <b>21534</b> Zócalo</p>	 <p>Ref. <b>21535</b> Suplemento zócalo</p>	 <p>Ref. <b>21537</b> Franja hoja</p>	 <p>Ref. <b>21538</b> Zócalo hoja</p>
 <p>Ref. <b>21539</b> Suplemento zócalo <b>*Consultar stock</b></p>	 <p>Ref. <b>21541</b> Travesaño</p>	 <p>Ref. <b>21542</b> Travesaño</p>	 <p>Ref. <b>21543</b> Travesaño</p>
 <p>Ref. <b>21544</b> Travesaño</p>	 <p>Ref. <b>21545</b> Rigidizador <b>*Consultar stock</b></p>	 <p>Ref. <b>21546</b> Semi rigidizador <b>*Consultar stock</b></p>	 <p>Ref. <b>21576</b> Complemento zócalo</p>

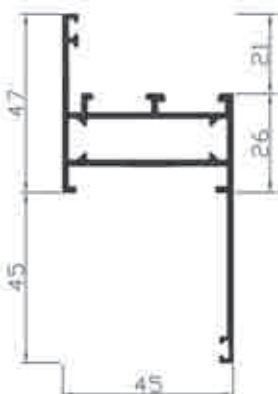
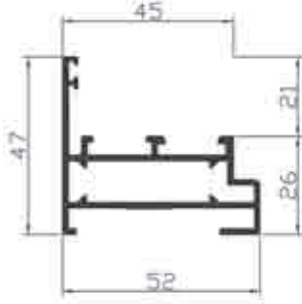
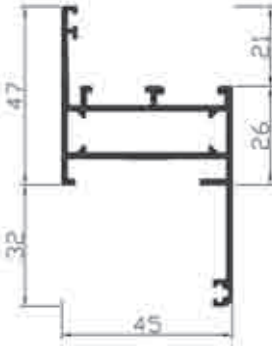
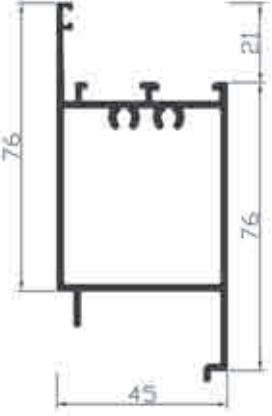
 <p>Ref. <b>21577</b> Esquinero <b>*Consultar stock</b></p>	 <p>Ref. <b>21579</b> Vierteaguas</p>	 <p>Ref. <b>21588</b> Hoja puerta apertura exterior</p>	 <p>Ref. <b>21589</b> Hoja puerta apertura interior</p>
 <p>Ref. <b>21591</b> Tapeta vaivén</p>	 <p>Ref. <b>21592</b> Tapeta vaivén</p>	 <p>Ref. <b>21593</b> Inversor marco tenax</p>	 <p>Ref. <b>21594</b> Tapeta marco</p>
 <p>Ref. <b>21611</b> Marco con tapajuntas</p>	 <p>Ref. <b>21612</b> Marco coplanario</p>	 <p>Ref. <b>21618</b> Marco con tapajuntas</p>	 <p>Ref. <b>21629</b> Suplemento zócalo <b>*Consultar stock</b></p>

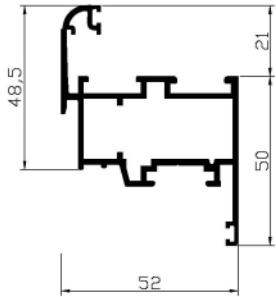

Ref. **21640**  
Hoja punto redondo resalte

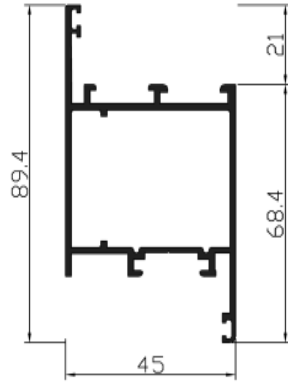

Ref. **21642**  
Hoja balconera

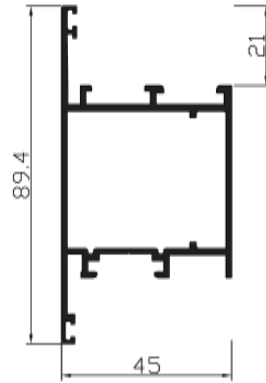

Ref. **21645**  
Hoja balconera apertura exterior

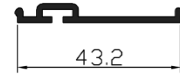

Ref. **21659**  
Suplemento zócalo

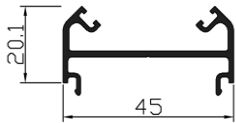

Ref. **21795**  
Acoplamiento tubo redondo  
\*Consultar stock

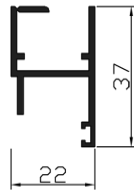

Ref. **24444**  
Perfil cajón registro

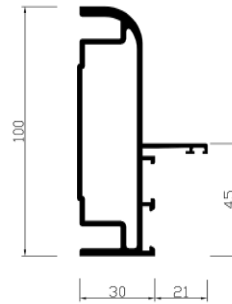

Ref. **24524**  
Semi rigidizador  
\* Consultar stock

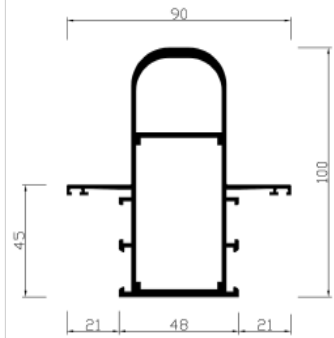

Ref. **24525**  
Rigidizador  
\* Consultar stock

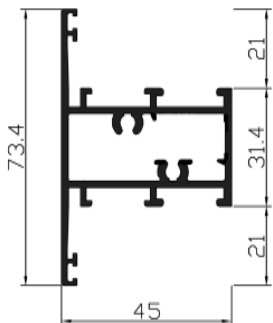

Ref. **24529**  
Travesaño

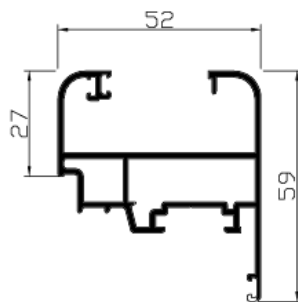



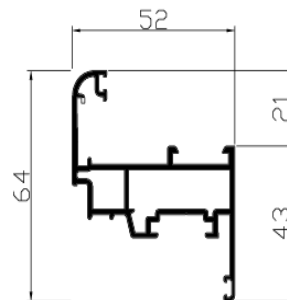

Ref. **24539**  
Hoja vidrio directo  
\* Consultar stock

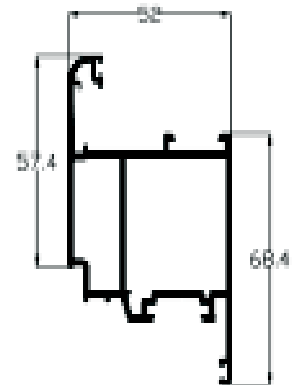

Ref. **24540**  
Hoja ventana de punto redondo

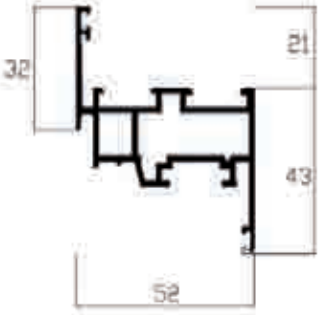
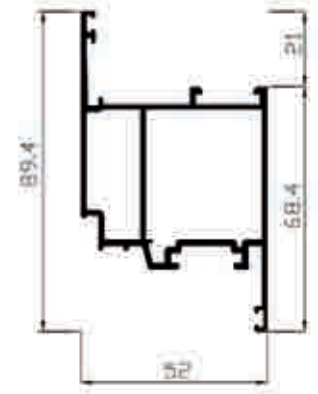
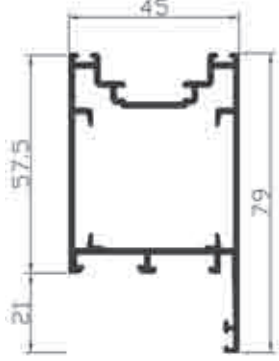

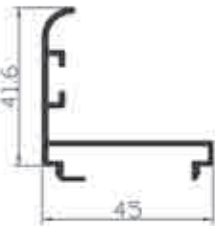
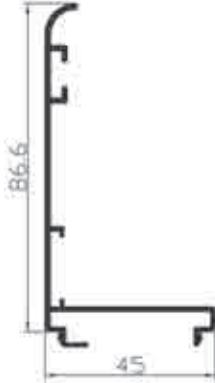
Ref. **24543**  
Hoja balconera

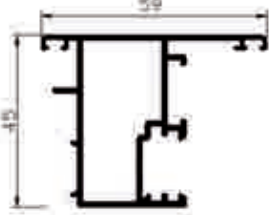
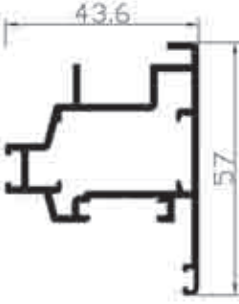
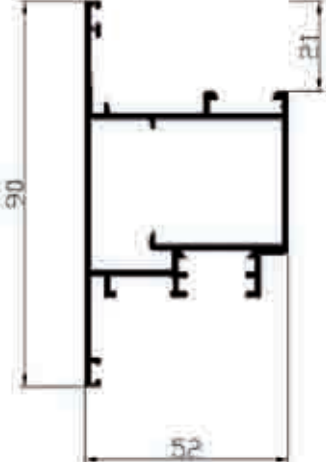
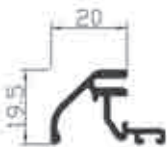
 <p>Ref. <b>24544</b> Hoja ventana recta</p>	 <p>Ref. <b>24546</b> Hoja balconera</p>	 <p>Ref. <b>24547</b> Hoja vaivén <b>* Consultar stock</b></p>	 <p>Ref. <b>24561</b> Tapeta base registro</p>
 <p>Ref. <b>24562</b> Angulo registro 41,6 mm. <b>* Consultar stock</b></p>	 <p>Ref. <b>24563</b> Angulo registro 86,6 mm. <b>* Consultar stock</b></p>	 <p>Ref. <b>24567</b> Tapeta marco vaivén.</p>	 <p>Ref. <b>24573</b> Acoplamiento central doble hoja</p>
 <p>Ref. <b>21521</b> Acoplamiento pivotante</p>	 <p>Ref. <b>21527</b> Hoja pivotante</p>	 <p>Ref. <b>27532</b> Perfil vierteaguas para zócalo</p>	

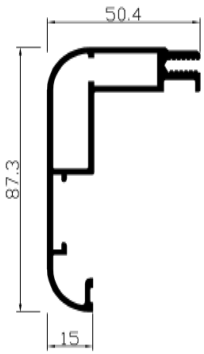

Ref. **121581**  
Semi marco exterior

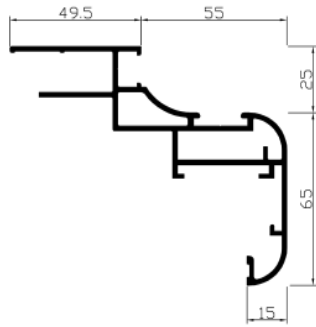

Ref. **121582**  
Semi marco interior

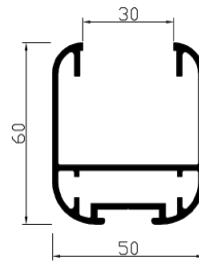

Ref. **121585**  
Hoja

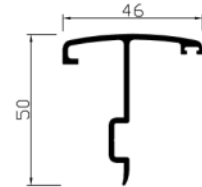

Ref. **121596**  
Acoplamiento dos hojas

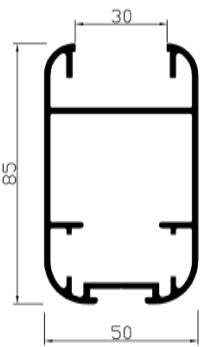

Ref. **121685**  
Hoja reforzada

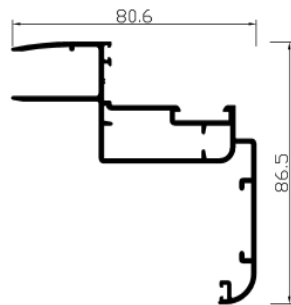

Ref. **121692**  
Semi marco interior

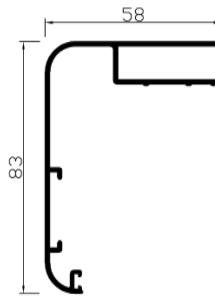

Ref. **121694**  
Semi marco exterior

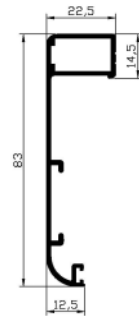

Ref. **121377**  
Semi marco exterior pared 60

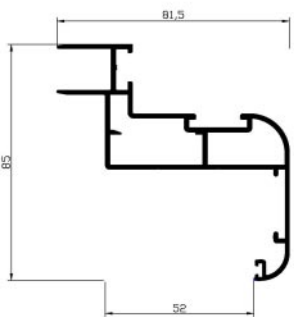

Ref. **121378**  
Semi marco interior pared 60

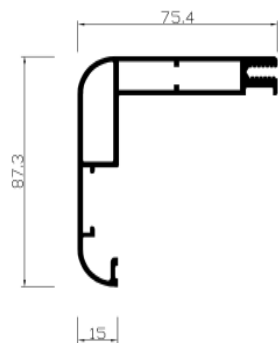

Ref. **121681**  
Semi marco exterior

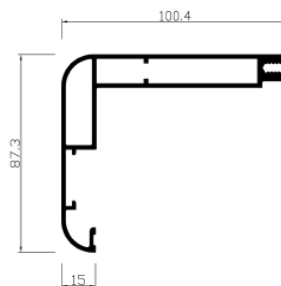

Ref. **121682**  
Semi marco exterior

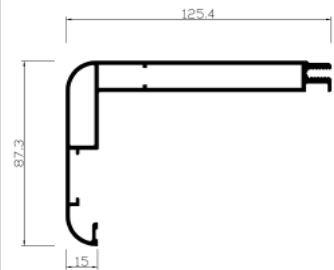

Ref. **121683**  
Semi marco exterior

# Practicable Abithal Euro-Keeper 45

Perfiles extrusionados en aleación 6060 (EN 573-3)  
Estado de suministro T-5 (EN 755-2)  
Tolerancias de dimensiones y espesores según norma EN 755-9

Los ensayos han sido realizados en ISTDIL (Roma), en una ventana de dos hojas de medidas 1200 x 1400 mm., con los siguientes resultados:

Permeabilidad al aire	Clase A-3
Estanqueidad al agua	Clase E-4
Resistencia al viento	Clase V-3
Transmitancia térmica	$U_w=2,75 \text{ W/m}^2 \text{ K}$

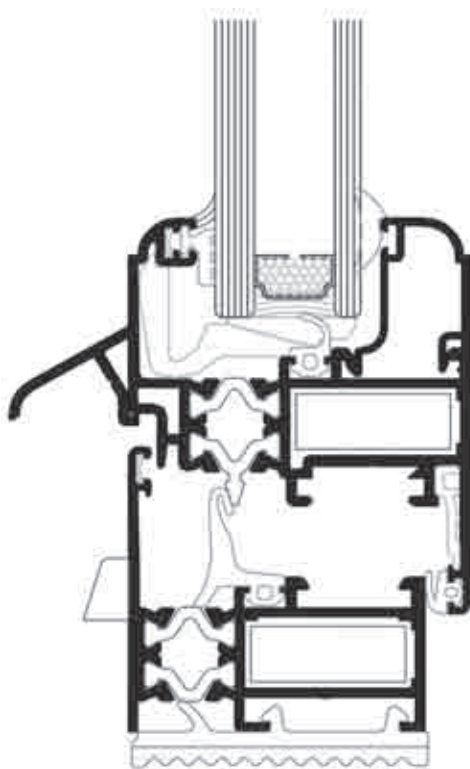

Atención, existe la posibilidad de realizar acabados en bicolor,  
**\*consultar**

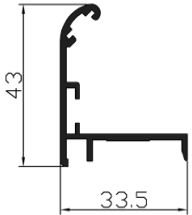
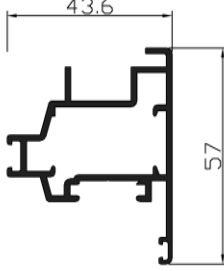
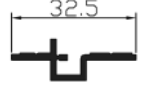
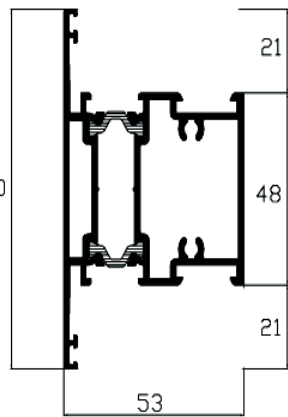
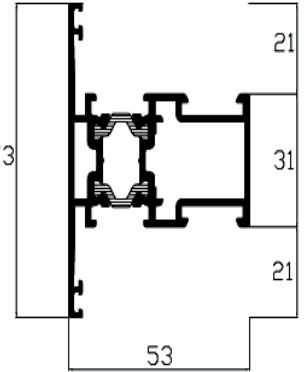
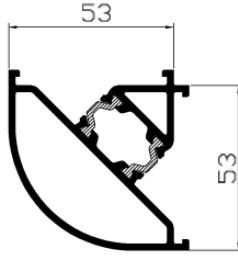
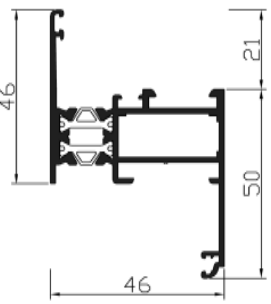
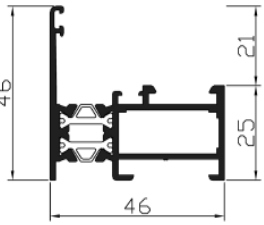
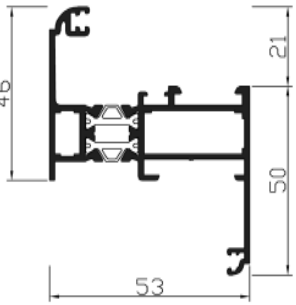
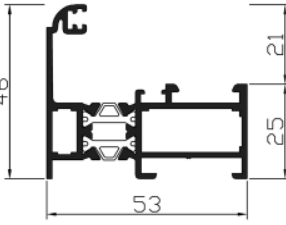
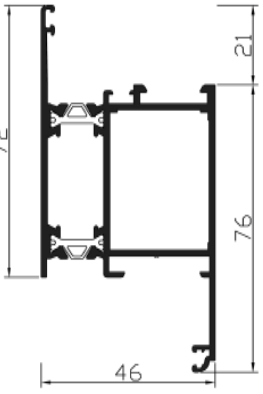

 <p>Ref. <b>20788</b> Pletina accionamiento cremona</p>	 <p>Ref. <b>21350</b> Angulo para registro</p>	 <p>Ref. <b>21521</b> Acoplamiento pivotante</p>	 <p>Ref. <b>21351</b> Base registro</p>
 <p>Ref. <b>22041</b> Travesaño</p>	 <p>Ref. <b>22046</b> Travesaño</p>	 <p>Ref. <b>22133</b> Esquinero</p>	 <p>Ref. <b>22700*</b> Marco ventana con tapajuntas</p>
 <p>Ref. <b>22701*</b> Marco ventana</p>	 <p>Ref. <b>22704</b> Marco de 53 mm con tapajuntas</p>	 <p>Ref. <b>22705</b> Marco de 53 mm</p>	 <p>Ref. <b>22706</b> Marco puerta con tapajuntas</p>





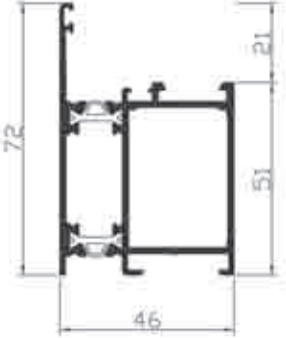
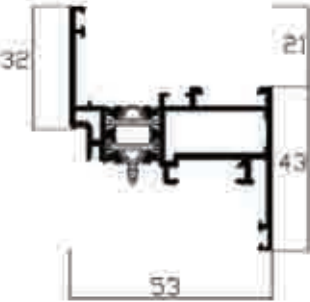
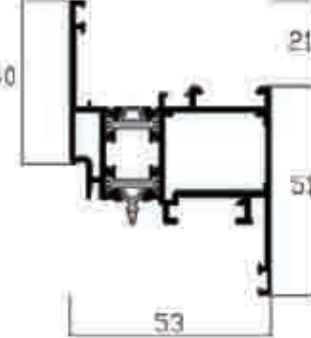
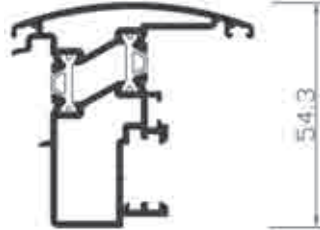
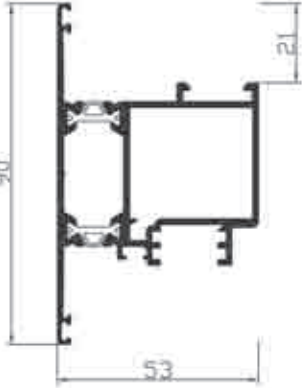
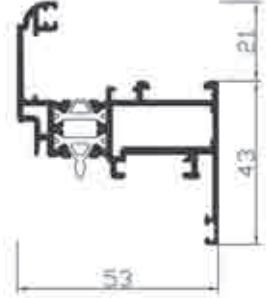
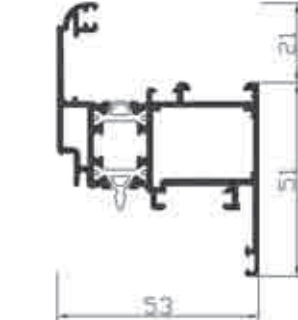
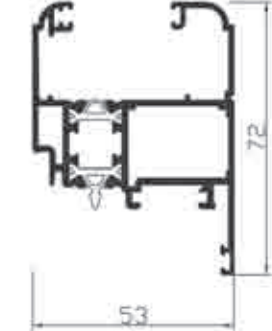
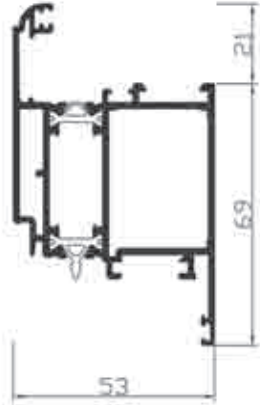
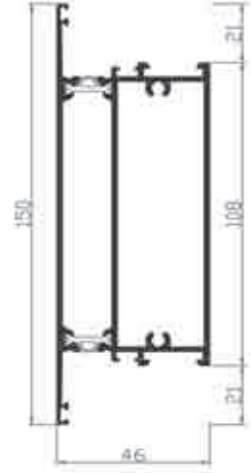

¡¡ATENCIÓN!!.. EXISTE LA POSIBILIDAD DE REALIZAR ACABADOS EN BICOLOR

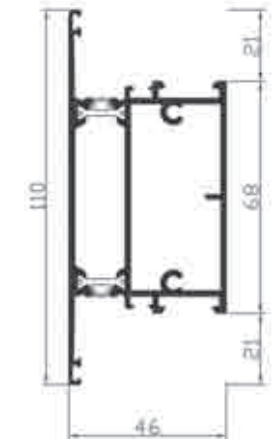
\* PERFILES QUE SE PUEDEN LACAR EN BICOLOR

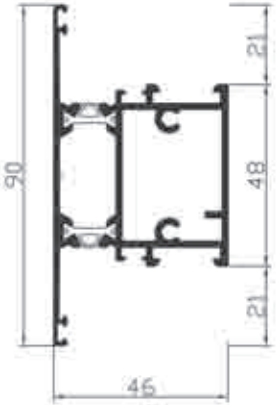

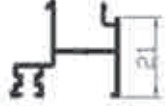
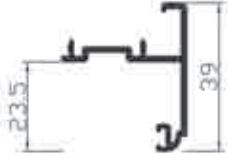
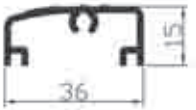
# Practicable Abithal Euro-Keeper 45

 <p><b>Ref. 22707*</b> Marco puerta</p>	 <p><b>Ref. 22720</b> Hoja ventana recta</p>	 <p><b>Ref. 22721</b> Hoja ventana recta</p>	 <p><b>Ref. 22733*</b> Acoplamiento dos hojas</p>
 <p><b>Ref. 22737</b> Hoja pivotante * Consultar stock</p>	 <p><b>Ref. 22738*</b> Hoja ventana</p>	 <p><b>Ref. 22739*</b> Hoja ventana</p>	 <p><b>Ref. 22740</b> Hoja ventana de directo vidrio</p>
 <p><b>Ref. 22741*</b> Hoja balconera.</p>	 <p><b>Ref. 22762</b> Franja / zócalo</p>	 <p><b>Ref. 22764</b> Suplemento zócalo</p>	 <p><b>Ref. 22766</b> Travesaño</p>

 <p>Ref. <b>22767*</b> Travesaño</p>	 <p>Ref. <b>24444</b> Perfil cajón registro</p>	 <p>Ref. <b>27528</b> Remate inferior franja / zócalo</p>	 <p>Ref. <b>27529</b> Cartela marco coplanario</p>
 <p>Ref. <b>27530</b> Remate suelo</p>	 <p>Ref. <b>27531</b> Remate acoplamiento franja / zócalo</p>	 <p>Ref. <b>27533</b> Acoplamiento marco bisagra tenax</p>	 <p>Ref. <b>27537</b> Vierteaguas</p>
 <p>Ref. <b>27994</b> Remate suelo</p>			

Perfiles extrusionados en aleación 6060 (EN 573-3)  
Estado de suministro T-5 (EN 755-2)  
Tolerancias de dimensiones y espesores según norma EN 755-9

Los ensayos han sido realizados en ICITE (Milán), en una ventana de dos hojas de medidas 1300 x 1400 mm., con los siguientes resultados:

Permeabilidad al aire	Clase A-3
Estanqueidad al agua	Clase E-4
Resistencia al viento	Clase V-3
Transmitancia térmica	$U_w=2,61 \text{ W/m}^2 \text{ K}$

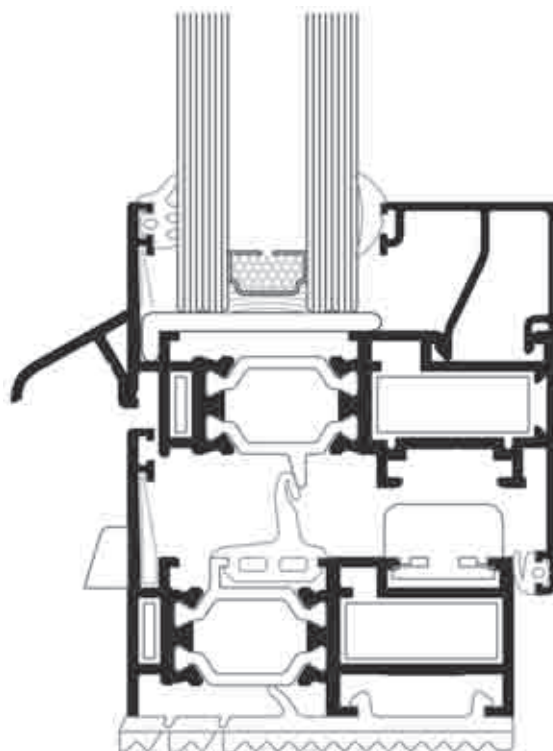

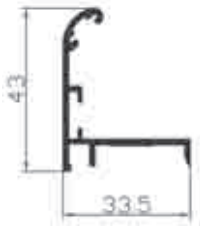

Ref **21350**  
Angulo para registro



Ref **21351**  
Base registro

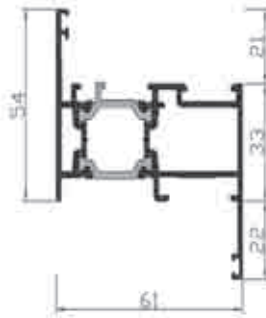

Ref **22052**  
Marco ventana con tapajuntas  
**\*Consultar stock**

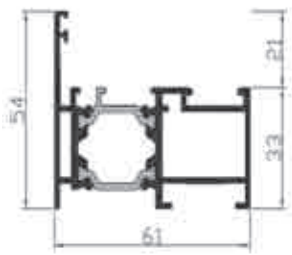

Ref **22155**  
Marco ventana  
**\*Consultar stock**

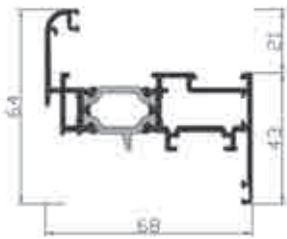

Ref **22062**  
Hoja ventana

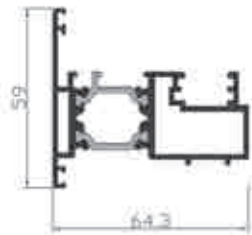

Ref **22067**  
Acoplamiento dos hojas

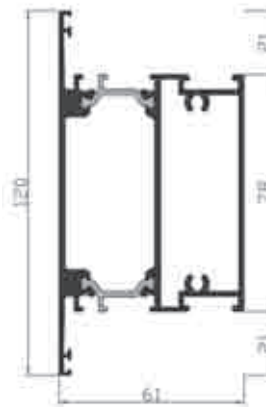

Ref **22070**  
Travesaño / franja



Ref **22073**  
Zócalo



Ref **22081**  
Acoplamiento zócalo



Ref **22083**  
Acoplamiento zócalo

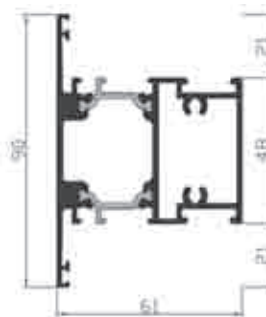

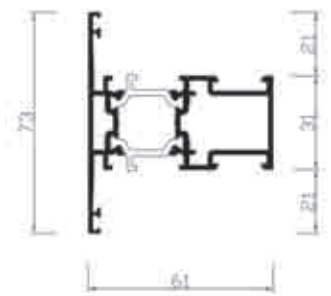

Ref **22091**  
Travesaño

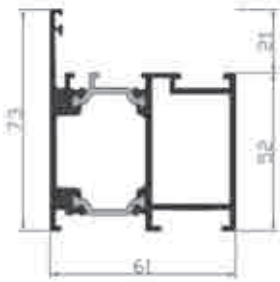
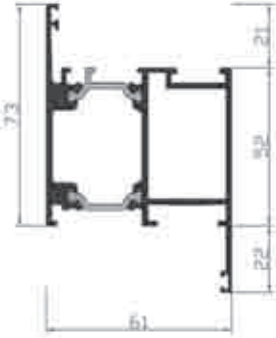
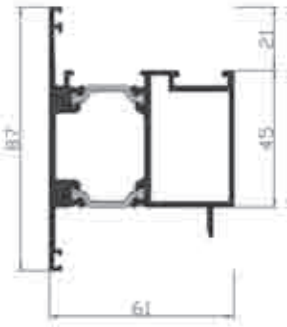
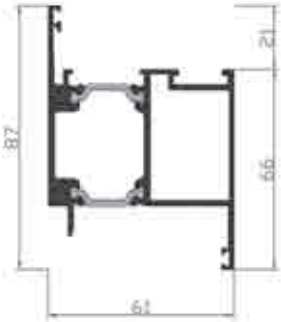
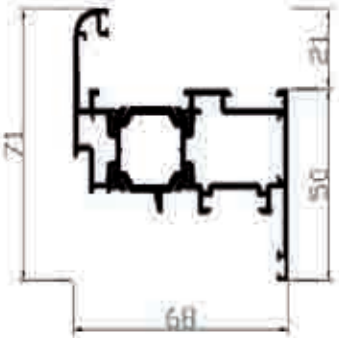
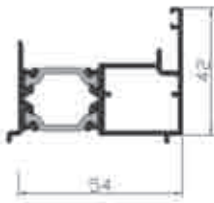
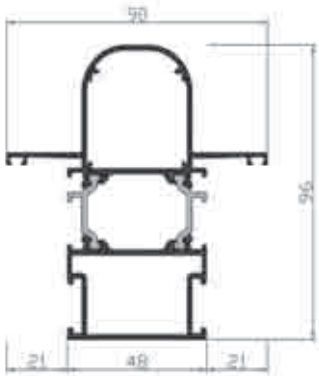
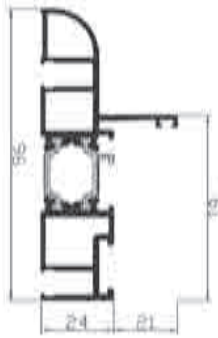
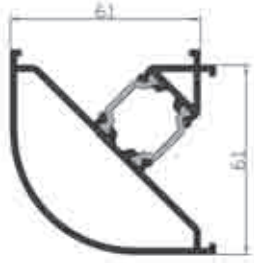
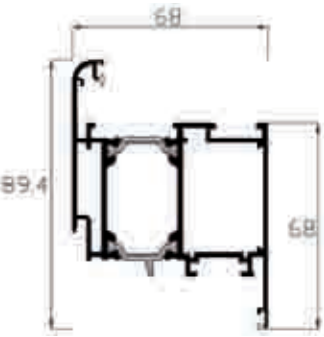

Ref **22093**  
Travesaño

# Practicable Abithal Keeper 61-68

 <p>Ref. <b>22121</b> Tapeta marco puerta</p>	 <p>Ref. <b>22150</b> Marco puerta</p>	 <p>Ref. <b>22151</b> Marco puerta con tapajuntas</p>	 <p>Ref. <b>22161</b> Hoja puerta apertura exterior * Consultar stock</p>
 <p>Ref. <b>22162</b> Hoja puerta apertura interior * Consultar stock</p>	 <p>Ref. <b>22164</b> Hoja ventana * Consultar stock</p>	 <p>Ref. <b>22172</b> Inversor marco puerta</p>	 <p>Ref. <b>22179</b> Rigidizador</p>
 <p>Ref. <b>22182</b> Semi rigidizador</p>	 <p>Ref. <b>22183</b> Esquinero 90°</p>	 <p>Ref. <b>22194</b> Hoja balconera punto redondo</p>	 <p>Ref. <b>24444</b> Perfil cajón registro</p>

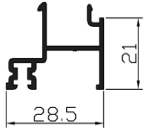

Ref. **27528**  
Remate inferior franja / zócalo

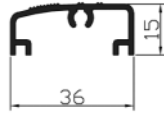

Ref. **27530**  
Remate suelo



Ref. **27531**  
Remate acoplamiento franja / zócalo

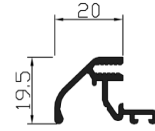

Ref. **27532**  
Perfil vierteaguas para zócalo

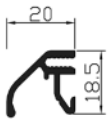

Ref. **27537**  
Vierteaguas

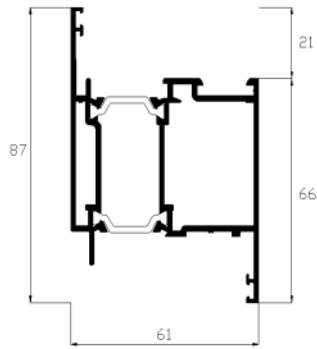

Ref. **22460**  
Hoja apertura interior  
**\*Consultar stock**

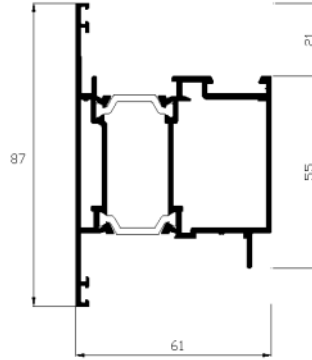

Ref. **22461**  
Hoja apertura exterior  
**\*Consultar stock**

Perfiles extrusionados en aleación 6060 (EN 573-3)  
Estado de suministro T-5 (EN 755-2)  
Tolerancias de dimensiones y espesores según norma EN 755-9

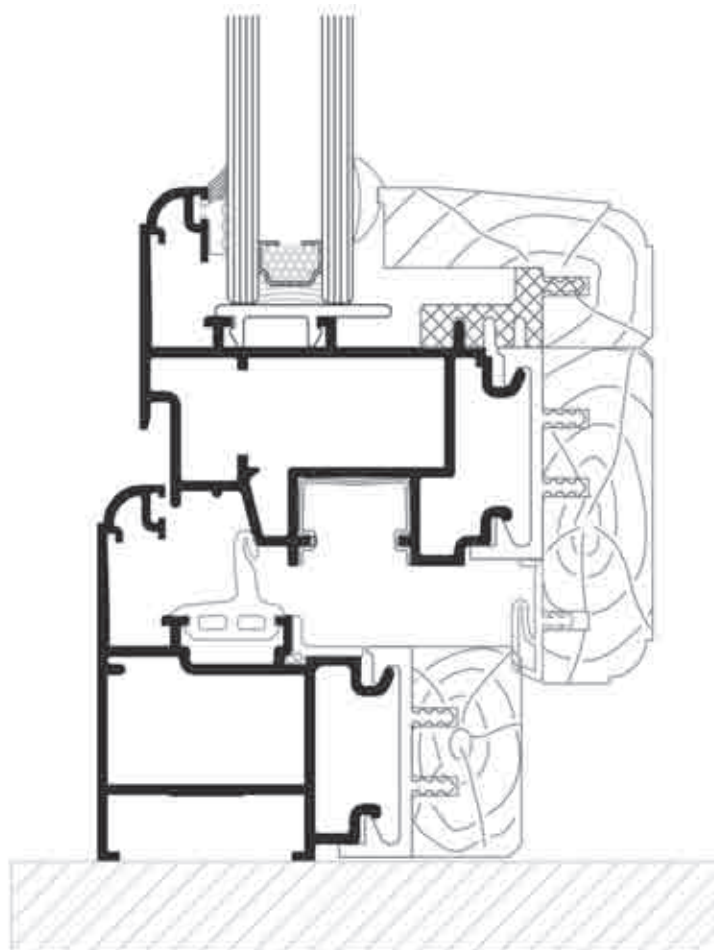

NOTA: LA MADERA SERÁ SIEMPRE ROBLE MACIZO NATURAL

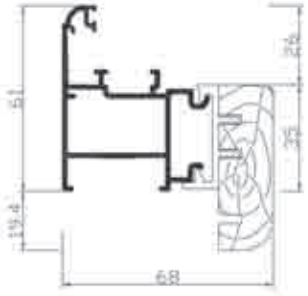

Ref. **21901+7L2**  
Marco ventana con tapajuntas

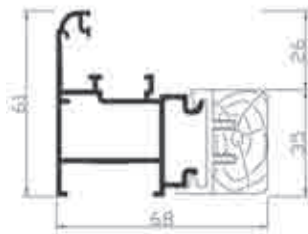

Ref. **21901+7L3**  
Marco ventana

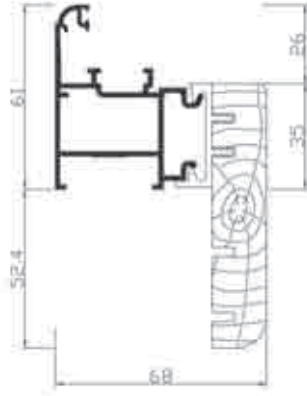

Ref. **21901+7L4**  
Marco ventana con tapajuntas

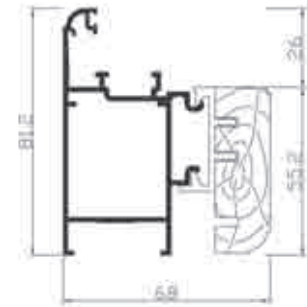

Ref. **21902+7L2**  
Marco puerta

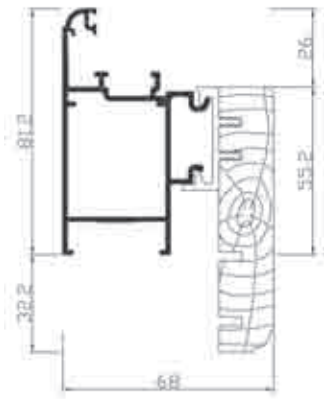

Ref. **21902+7L4**  
Marco puerta con tapajuntas

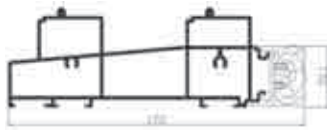

Ref. **21903+7L3**  
Marco inferior corredera elevable

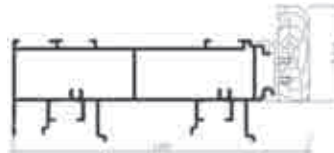

Ref. **21904+7L2**  
Marco superior corredera elevable

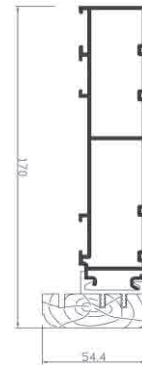

Ref. **21905+7L2**  
Marco lateal corredera elevable

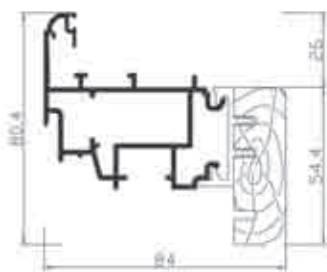

Ref. **21911+7L2**  
Hoja ventana

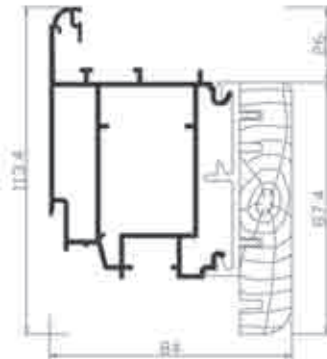

Ref. **21912+7L0**  
Hoja balconera

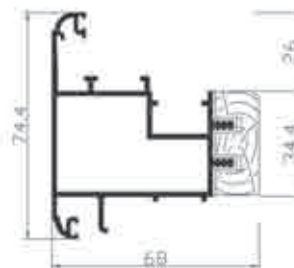



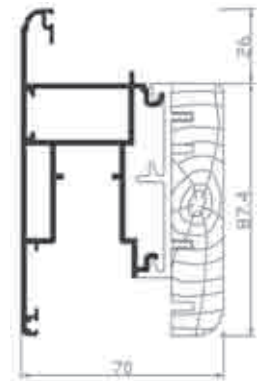



Ref. **21913+7L1**  
Acoplamiento dos hojas

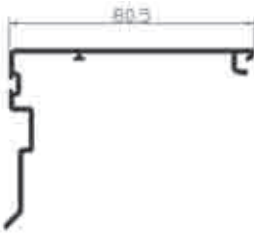
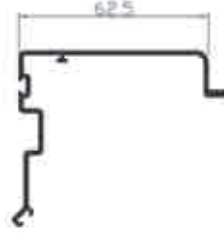
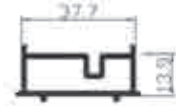

Ref. **21914+7L0**  
Hoja corredera elevable

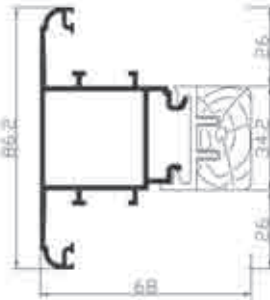
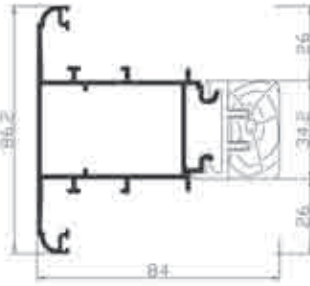
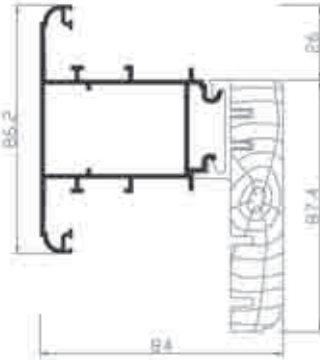
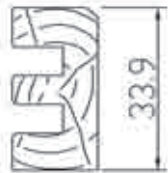

 <p>Ref. <b>21921</b> Perfil para cruce corredera</p>	 <p>Ref. <b>21922</b> Perfil para cruce corredera</p>	 <p>Ref. <b>21923</b> Acoplamiento marco lateral</p>	 <p>Ref. <b>21924</b> Acoplamiento hoja corredera fija</p>
 <p>Ref. <b>21925</b> Encuentro cuatro hojas correderas</p>	 <p>Ref. <b>21926</b> Guía superior marco</p>	 <p>Ref. <b>21927</b> Estanqueidad corredera</p>	 <p>Ref. <b>21928</b> Tapajuntas exterior marco corredera</p>
 <p>Ref. <b>21941+7L3</b> Travesaño marco</p>	 <p>Ref. <b>21942+7L3</b> Travesaño hoja</p>	 <p>Ref. <b>21942+7L4</b> Suplemento zócalo</p>	 <p>Ref. <b>7L1</b> Tapeta madera acoplamiento dos hojas</p>



Ref. **7L2**  
Tapeta madera 54,4 mm



Ref. **7L3**  
Tapeta madera 34,2 mm

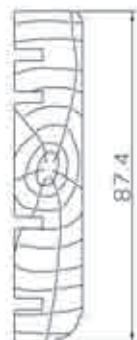

Ref. **7L4**  
Tapeta madera 87,4 mm



Ref. **7L5**  
Junquillo 29 mm

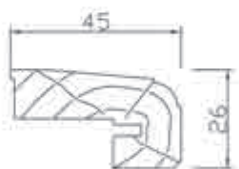



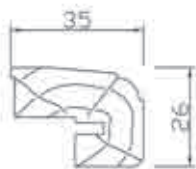



Ref. **7L6**  
Junquillo 45 mm

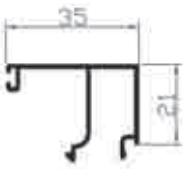
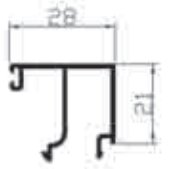

Ref. **7L7**  
Junquillo 35 mm

**\* Serie existente solamente en bruto. Consultar plazos de entrega.  
Madera acabado roble.**

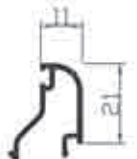
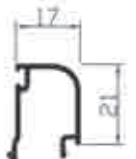
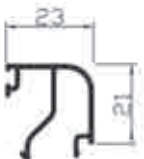
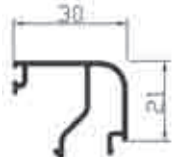
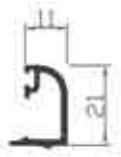
# Junquillos cámara europea

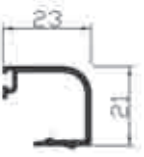
 <p>Ref. <b>20709</b> Junquillo recto de 35 mm</p>	 <p>Ref. <b>20710</b> Junquillo recto de 28 mm</p>	 <p>Ref. <b>20711</b> Junquillo recto de 21 mm</p>	 <p>Ref. <b>20712</b> Junquillo recto de 14 mm</p>
 <p>Ref. <b>21551</b> Junquillo recto de 9 mm</p>	 <p>Ref. <b>21565</b> Junquillo redondo de 11 mm clipado</p>	 <p>Ref. <b>21566</b> Junquillo redondo de 17 mm clipado</p>	 <p>Ref. <b>21567</b> Junquillo redondo de 23 mm clipado</p>
 <p>Ref. <b>21568</b> Junquillo redondo de 30 mm clipado</p>	 <p>Ref. <b>21675</b> Junquillo redondo de 11 mm con grapa</p>	 <p>Ref. <b>21676</b> Junquillo redondo de 17 mm con grapa</p>	 <p>Ref. <b>21677</b> Junquillo redondo de 23 mm con grapa</p>

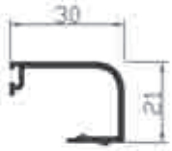

Ref. **21678**  
Junquillo redondo de 30 mm con grapa



Ref. **21780**  
Junquillo redondo de 14 mm con grapa

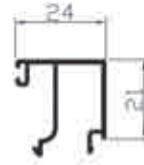

Ref. **21782**  
Junquillo recto de 24 mm

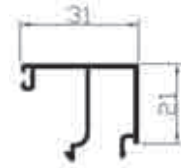

Ref. **21783**  
Junquillo recto de 31 mm.

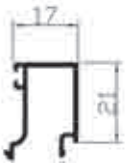

Ref. **21786**  
Junquillo recto de 17 mm.

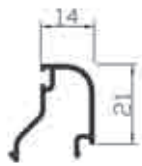

Ref. **21787**  
Junquillo redondo de 14 mm clipado

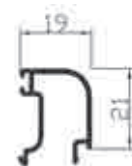

Ref. **21789**  
Junquillo redondo de 19mm clipado



Ref. **24558**  
Junquillo redondo de 19 mm con grapa



Ref. **20737**  
Junquillo recto de 4,5 mm

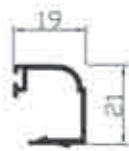

Ref. **24550**  
Junquillo redondo resalte de 19 mm con grapa

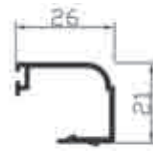

Ref. **24551**  
Junquillo redondo resalte de 26 mm con grapa

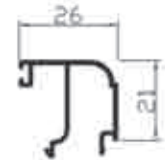

Ref. **24552**  
Junquillo redondo resalte de 26 mm clipado

# Junquillos cámara europea

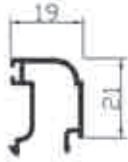

Ref **124553**

Junquillo redondo resalte de 19 mm clipado



Ref **124554**

Junquillo redondo resalte de 14 mm clipado

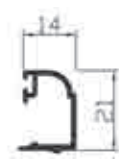

Ref **124555**

Junquillo redondo resalte de 14 mm con grapa

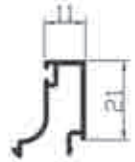

Ref **124556**

Junquillo recto de 11 mm

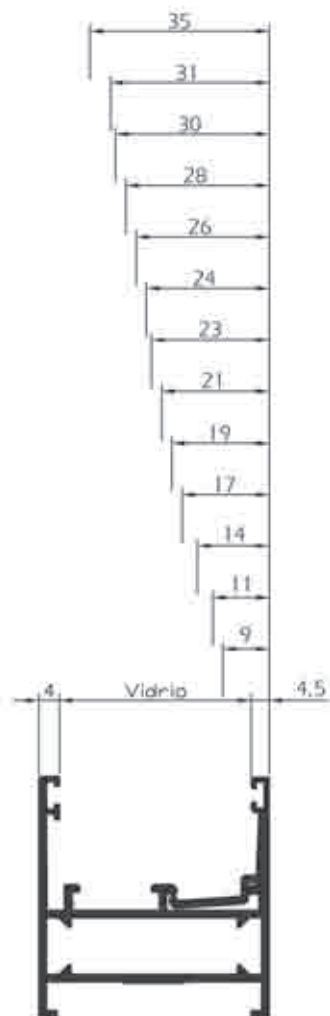







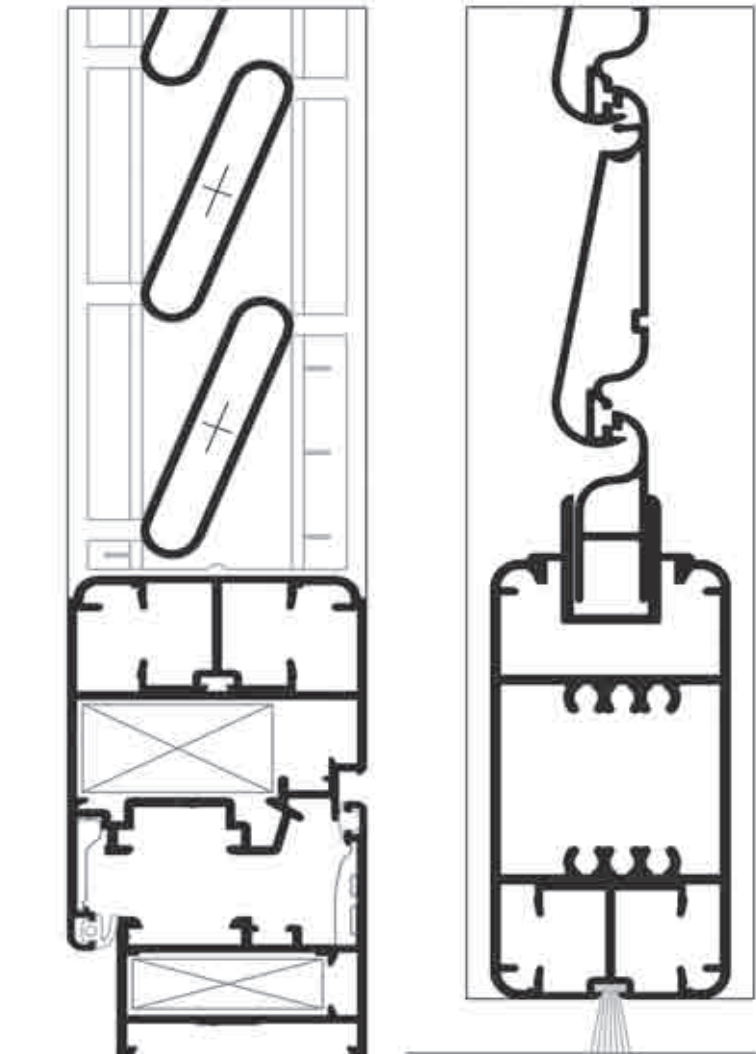

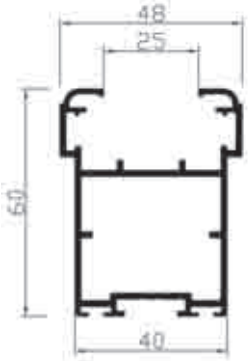
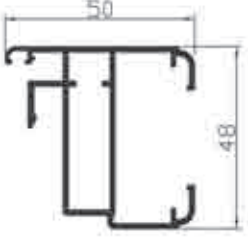
Ref <b>20709</b>				
Ref <b>21783</b>				
	Ref <b>21678</b>	Ref <b>21568</b>		
Ref <b>20710</b>				
			Ref <b>124551</b>	Ref <b>124552</b>
Ref <b>21782</b>				
	Ref <b>21677</b>	Ref <b>21567</b>		
Ref <b>20711</b>				
	Ref <b>24558</b>	Ref <b>21789</b>	Ref <b>124550</b>	Ref <b>124553</b>
Ref <b>21786</b>	Ref <b>21676</b>	Ref <b>21566</b>		
Ref <b>20712</b>	Ref <b>21780</b>	Ref <b>21787</b>	Ref <b>124555</b>	Ref <b>124554</b>
Ref <b>124556</b>	Ref <b>21675</b>	Ref <b>21565</b>		
Ref <b>21551</b>				
Ref <b>20737</b>				

Ejemplo de tabla de aplicación de junquillos para acristalamiento. Esquema representado serie GREEN.

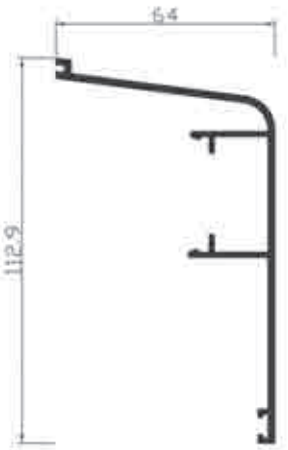
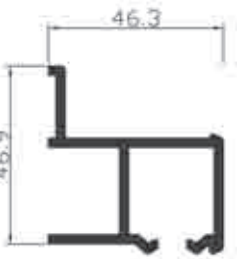
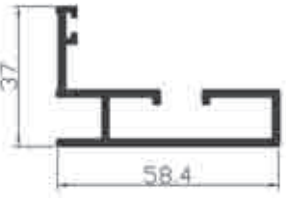

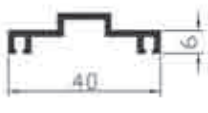
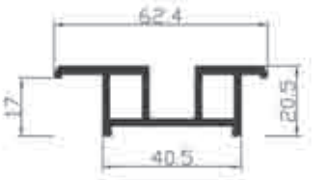

Perfiles extrusionados en aleación 6060 (EN 573-3)  
Estado de suministro T-5 (EN 755-2)  
Tolerancias de dimensiones y espesores según norma EN 755-9

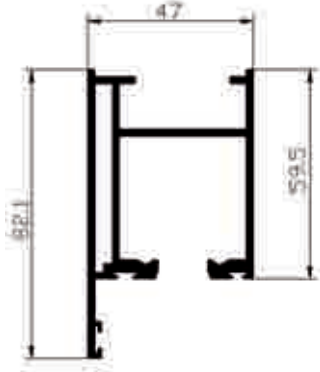
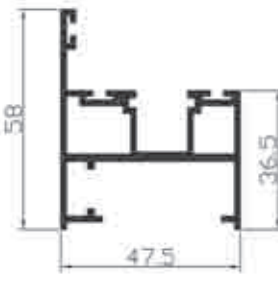
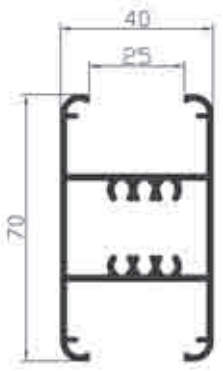
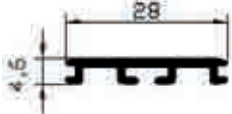
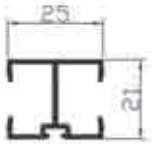
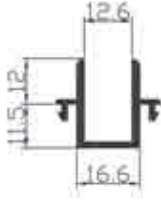
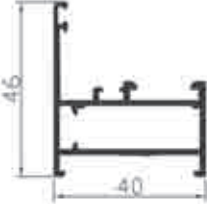
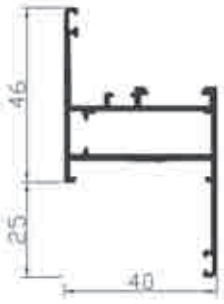
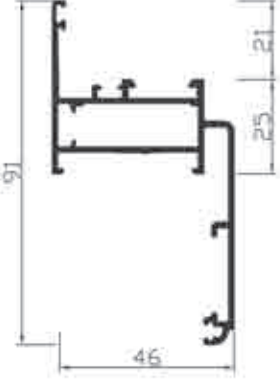
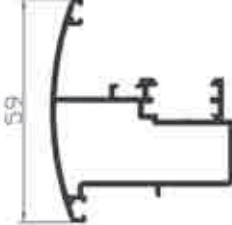
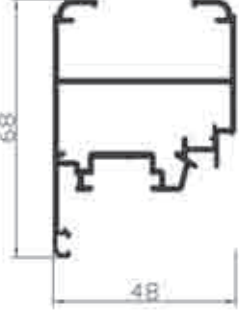

 <p>Ref. <b>503</b> Lama fija</p>	 <p>Ref. <b>2517</b> Hoja corredera / plegable</p>	 <p>Ref. <b>2518</b> Acoplamiento fijos</p>	 <p>Ref. <b>12506</b> Lama móvil</p>
 <p>Ref. <b>12507</b> Distanciador</p>	 <p>Ref. <b>12508</b> Distanciador</p>	 <p>Ref. <b>16073</b> Tapeta guia superior corredera</p>	 <p>Ref. <b>16074</b> Guia superior corredera</p>
 <p>Ref. <b>16075</b> Guia inferior corredera</p>	 <p>Ref. <b>16077</b> Tapeta hoja corredera</p>	 <p>Ref. <b>19632</b> Remate hoja plegable</p>	 <p>Ref. <b>19634</b> Guia inferior embutida plegable</p>

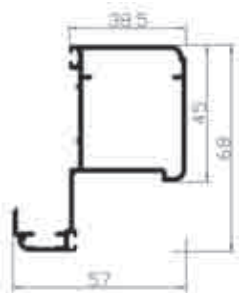
 <p>Ref. <b>19637</b> Tapeta solape</p>	 <p>Ref. <b>19643</b> Guia superior plegable</p>	 <p>Ref. <b>20373</b> Marco lateral / inferior plegable</p>	 <p>Ref. <b>24406</b> Travesaño horizontal</p>
 <p>Ref. <b>24455</b> Tapeta remate</p>	 <p>Ref. <b>24457</b> Acoplamiento travesaño / hoja</p>	 <p>Ref. <b>24459</b> Perfil para distanciadores</p>	 <p>Ref. <b>27000</b> Marco ventana</p>
 <p>Ref. <b>27001</b> Marco con tapajuntas</p>	 <p>Ref. <b>27006</b> Marco coplanario con tapajuntas * Consultar stock</p>	 <p>Ref. <b>27031</b> Acoplamiento dos hojas</p>	 <p>Ref. <b>27033</b> Hoja practicable</p>

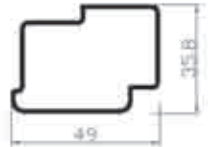

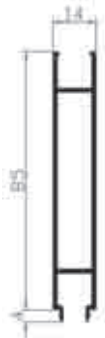
 <p>Ref. <b>21704</b> Hoja portalama</p>	 <p>Ref. <b>21707</b> Refuerzo intermedio</p>	 <p>Ref. <b>21708</b> Apoyo refuerzo</p>	 <p>Ref. <b>21751</b> Acoplamiento dos hojas</p>
 <p>Ref. <b>21752</b> Remate inferior</p>	 <p>Ref. <b>21757</b> Lama porticón</p>		



Perfiles extrusionados en aleación 6063 (UNE - 38337)  
Estado de suministro T-5  
Tolerancias de dimensiones y espesores según norma UNE 38066

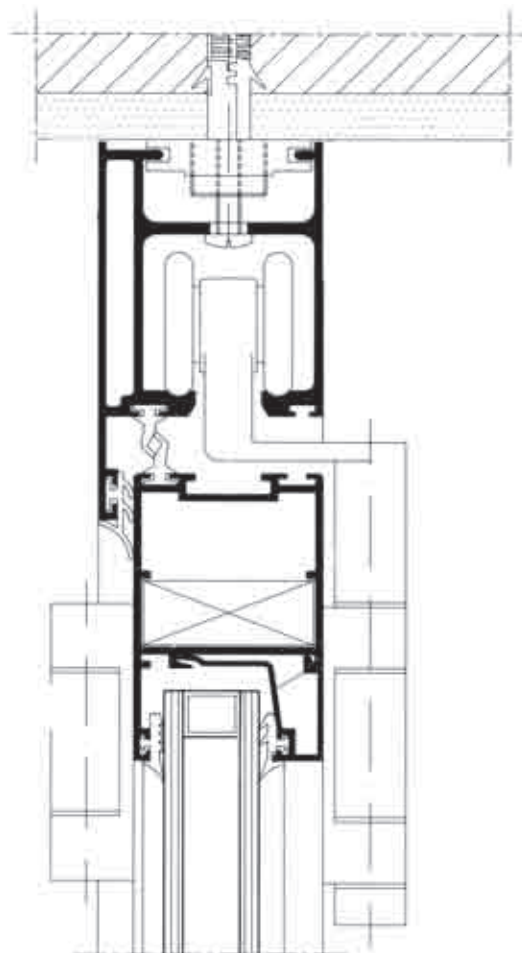

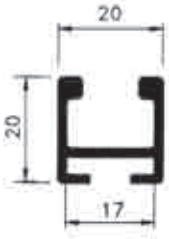

Ref. **16076**  
Guía central  
\* Consultar stock

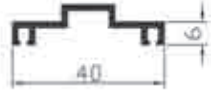

Ref. **19632**  
Remate inferior hoja

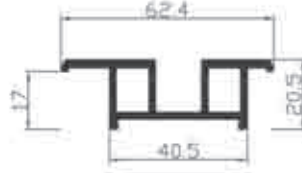

Ref. **19634**  
Guía inferior embutida

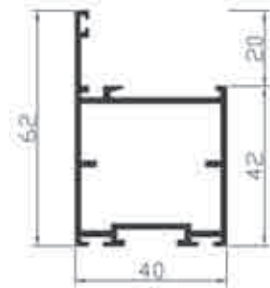

Ref. **19635**  
Hoja

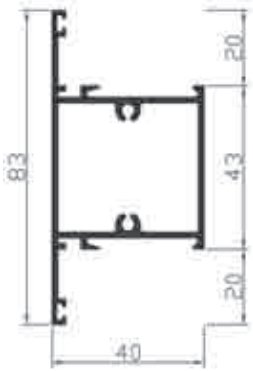

Ref. **19636**  
Travesaño



Ref. **19637**  
Tapeta solape

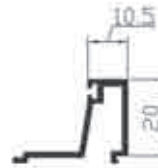

Ref. **19638**  
Junquillo recto de 10,5 mm



Ref. **19639**  
Junquillo recto de 24,5 mm

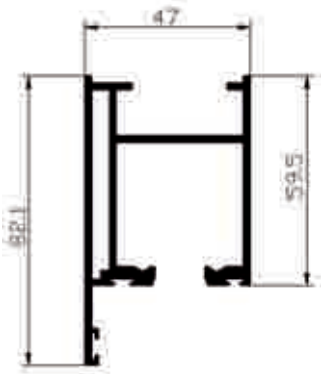

Ref. **19643**  
Guía superior

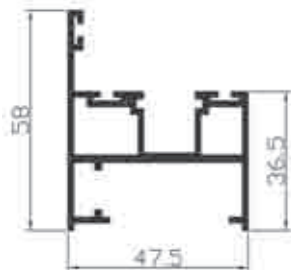

Ref. **20373**  
Marco lateral / inferior

Perfiles extrusionados en aleación 6060 (EN 573-3)  
Estado de suministro T-5 (EN 755-2)  
Tolerancias de dimensiones y espesores según norma EN 755-9

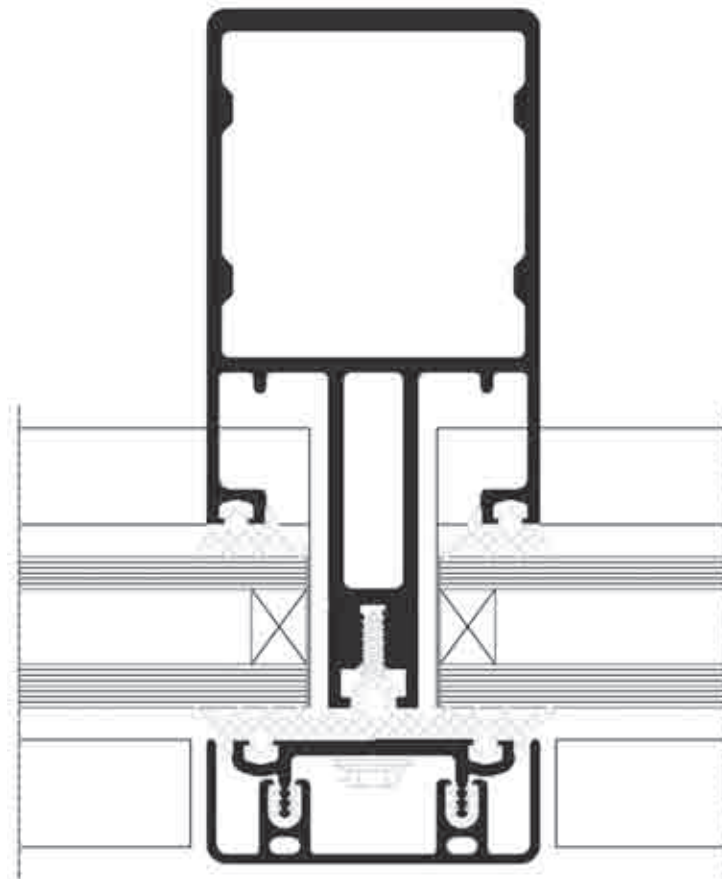

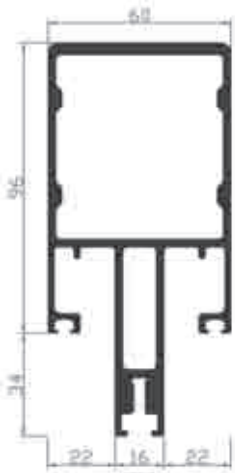

Ref. **21106**  
Montante

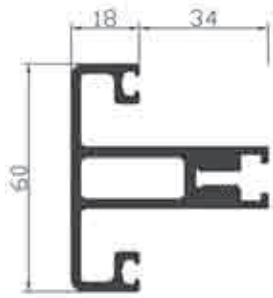

Ref. **21107**  
Travesaño

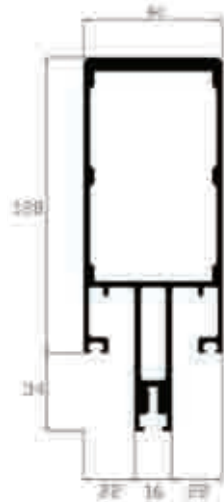

Ref. **21109**  
Rigidizador 162 mm.



Ref. **21110**  
Tapeta presión vidrio



Ref. **21111**  
Tapeta horizontal

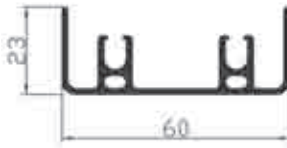

Ref. **21112**  
Tapeta vertical



Ref. **21115**  
Reductor vidrio

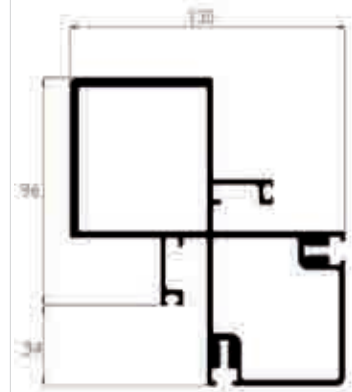

Ref. **21124**  
Esquinero

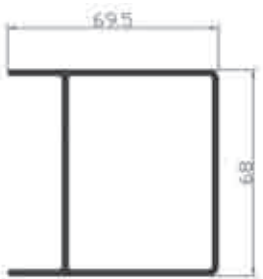

Ref. **21128**  
Refuerzo travesaño

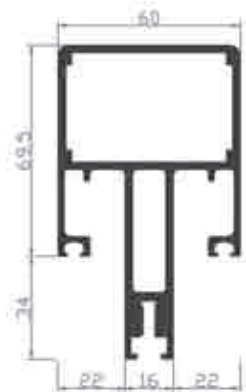

Ref. **21130**  
Montante



Ref. **21136**  
Marco abertura externa



Ref. **21137**  
Hoja estructural

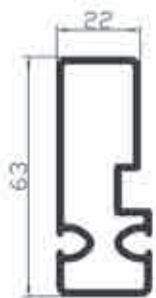

Ref. **21139**  
Remate pared

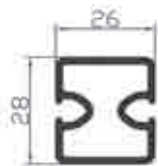

Ref. **21143**  
Suplemento remate



Ref. **21231**  
Refuerzo unión montantes



Ref. **21234**  
Refuerzo unión montantes

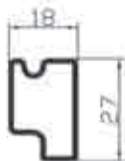

Ref. **21235**  
Canalón para drenaje en union de montantes

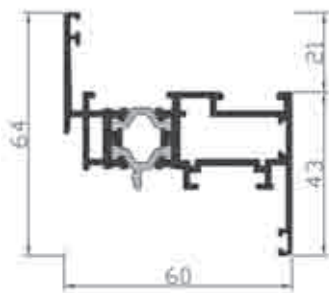

Ref. **22010**  
Hoja ventana

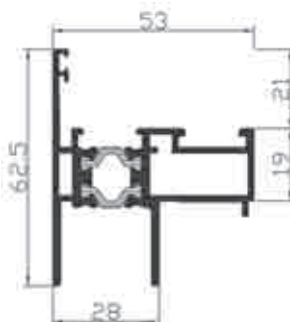

Ref. **22310**  
Marco ventana

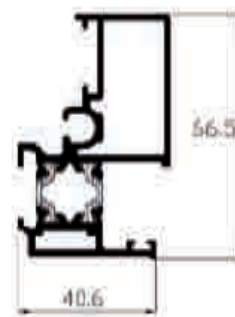

Ref. **22320**  
Hoja estructural wall

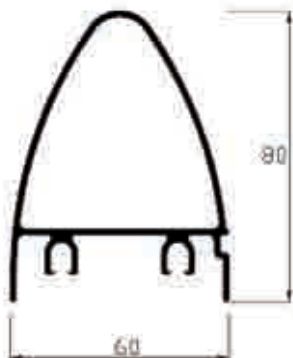

Ref. **24601**  
Tapeta ala avión

Esta serie se debe consultar los stocks

En el presente catalogo se han anulado los perfiles y accesorios de las siguientes series:

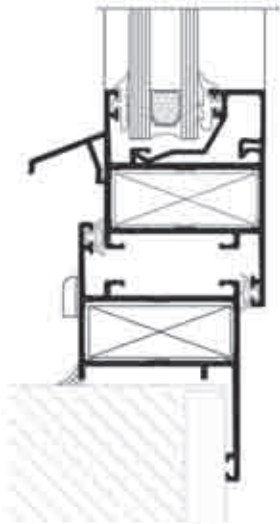

Practicable 40 lisa

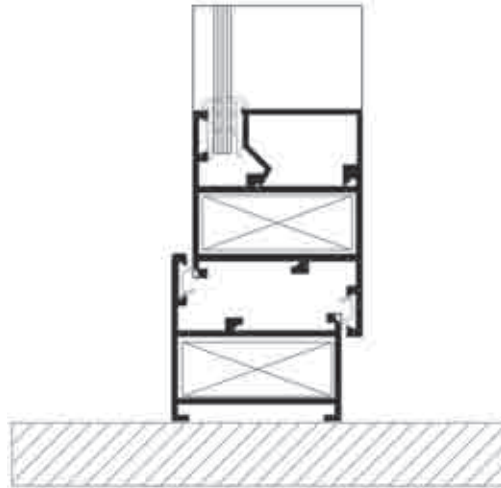

Practicable Samblex 40i

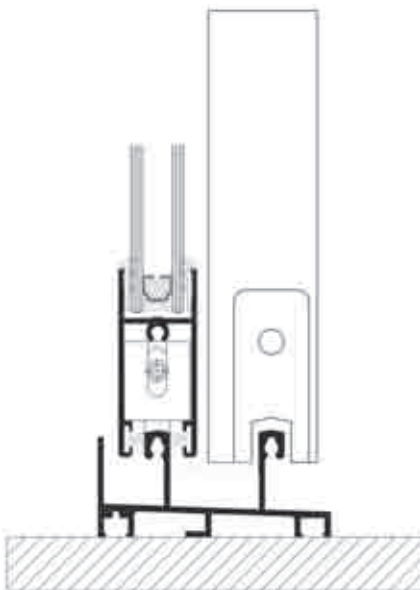

Corredera Samblex 65i

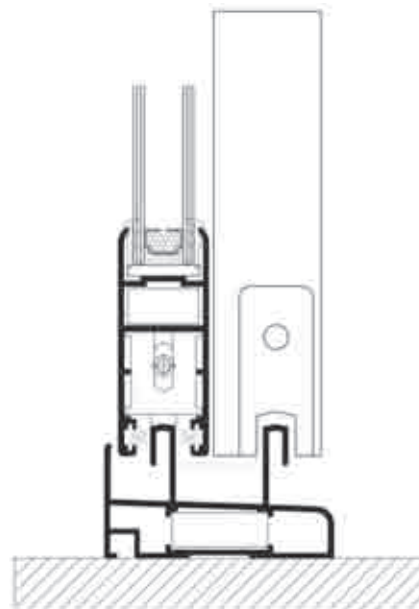

Corredera Samblex P65CO













































CATÁLOGO GENERAL 2008 | accesorios













# Accesorios

<u>Producto</u>	<u>Pág</u>
Escuadras	72
Bisagras	75
Fresas	76
Cremonas	77
Herrajes oscilo y compases	78
Decor-Stil	79
Uniones	80
Tapas estanqueidad	81
Juntas y gomas	82
Cerraduras, cierres y tiradores	84
Herrajes Euro Mallorquina	88
Accesorios varios	88
Ruedas y cortavientos	89
Barandilla Mixta	90
Accesorios barandillas	91
Herrajes Mallorquina Oscura	96
Herrajes Wood	98
Accesorios Euro Runner 250tt	104
Premarco	106
Accesorios Wall	107



















				
Forro 65018	Forro 65020	P70CO	P70CO	Cajón registro persiana 24444
Ref. <b>105</b> Escuadra de alineamiento 105	Ref. <b>120</b> Escuadra de alineamiento 120	Ref. <b>242</b> Escuadra de 11 x 24 mm	Ref. <b>243</b> Escuadra de 11 x 24 mm.	Ref. <b>308</b> Escuadra para perfil registro de persiana
				
	Forros	Forros		
Ref. <b>309</b> Escuadra para perfil 21704	Ref. <b>902</b> Escuadra de alineamiento 902	Ref. <b>903</b> Escuadra de alineamiento 903	Ref. <b>1215</b> Escuadra pequeña	Ref. <b>1240</b> Escuadra puerta rpt 65i
				
P 70 CO TT			Euro 40 Green Runner 61-90 tres carriles	Euro 40 Green
Ref. <b>1711</b> Escuadra de 11 x 16 mm.	Ref. <b>2215</b> Escuadra tetones hoja	Ref. <b>2240</b> Escuadra puerta	Ref. <b>9630</b> Escuadra de 11 x 32,5 mm.	Ref. <b>9632</b> Escuadra a grados variables
				
Keeper 45	Euro 40 Green	Euro 40 Green Wood	Series practicables Abithal	Euro-keeper 45 Green
Ref. <b>9633</b> Escuadra a grados variables	Ref. <b>9652</b> Escuadra de 36 x 32 mm.	Ref. <b>IAS02</b> Escuadra de 18 x 32,5 mm.	Ref. <b>IAS07</b> Escuadra de alineamiento Inox	Ref. <b>IAS28</b> Escuadra de 31,8 x 28,8 mm.

# Escuadras

				
Euro 40 Green Wood  Ref. <b>1AS36</b> Escuadra de 32 x 36 mm.	Euro 40 Green Wood  Ref. <b>1AS56</b> Escuadra de tornillos 36 x 32,5 mm.	Euro-keeper 45  Ref. <b>1AS87</b> Escuadra de alineamiento con excéntrica de presión marco	Keeper 61-68 Elevable Runner 250 tt  Ref. <b>1AS88</b> Escuadra de alineamiento con excéntrica de presión marco/hoja	Green Keeper 61-68  Ref. <b>1AS90</b> Escuadra de alineamiento en nylon para hoja
				
Euro 40 Green Euro-keeper 45 Keeper 61-68  Ref. <b>1AS96</b> Escuadra de alineamiento en nylon para marco	Euro 40 Green Euro-keeper 45  Ref. <b>1AS97</b> Escuadra de alineamiento en nylon para hoja	Euro 40 Green Euro-keeper 45 Keeper 61-68  Ref. <b>1AV01</b> Escuadra calzo vidrio con expansor	Euro-keeper 45 Keeper 61-68 Elevable Runner 250tt  Ref. <b>1BS01</b> Escuadra de 11 x 26 mm.	Green Euro-keeper 45 Keeper 61-68 Elevable Runner 250tt  Ref. <b>1BS02</b> Escuadra de 18 x 26 mm.
				
Euro-keeper 45 Keeper 61-68  Ref. <b>1BS03</b> Escuadra de 36 x 26 mm.	Runner 61-90  Ref. <b>1BS04</b> Escuadra de 11 x 41 mm.	Runner 61-90 Runner 61-90 tt  Ref. <b>1BS05</b> Escuadra de 11 x 21 mm.	Runner 61-90 tt  Ref. <b>1BS08</b> Escuadra de 11 x 18 mm.	Euro-keeper 45  Ref. <b>1BS31</b> Escuadra a grados variables de 18 x 26 mm.
				
Green Euro-keeper 45  Ref. <b>1BS65</b> Escuadra a grados variables de 11 x 26 mm.	Keeper 61-68  Ref. <b>2AS37</b> Escuadra de alineamiento	Keeper 61-68 Euro Keeper 45  Ref. <b>2AS55</b> Escuadra de tornillos 36 x 26	Euro-keeper 45 Keeper 61-68  Ref. <b>2AS81</b> Escuadra de alineamiento 3,7 x 11 mm.	Euro-keeper 45 Keeper 61-68  Ref. <b>2AS82</b> Escuadra de alineamiento 3,7 x 18 mm.

				
<p>Euro-keeper 45</p> <p>Ref. <b>2AS84</b> Escuadra de alineamiento para marco</p>	<p>Euro-keeper 45</p> <p>Ref. <b>2AS86</b> Escuadra de alineamiento</p>	<p>Euro-keeper 45</p> <p>Ref. <b>2AS87</b> Escuadra de alineamiento</p>	<p>Runner 61-90 tt</p> <p>Ref. <b>4AS01</b> Escuadra de alineamiento 3 x 11</p>	<p>Runner 61-90</p> <p>Ref. <b>4AS02</b> Escuadra de alineamiento 3 x 18</p>
				
<p>Euro mallorquina Plegable Garden</p> <p>Ref. <b>04A21</b> Escuadra 04A21</p>	<p>Runner 61-90</p> <p>Ref. <b>4MS65</b> Escuadra de plástico</p>	<p>Ref. <b>44039</b> Escuadra de alineamiento inox</p>	<p>Abithal Wall</p> <p>Ref. <b>5FS61</b> Escuadra a remarchar</p>	<p>Abithal Wall</p> <p>Ref. <b>5FS71</b> Escuadra a remarchar</p>
				
<p>Ref. <b>4500050-56-63</b> 50 -&gt; 50mm. 63 -&gt; 36,4 mm. 56 -&gt; 60 mm.</p>	<p>Forro 24563</p> <p>Ref. <b>6000005</b> Escuadra de alineamiento 8997/40</p>	<p>1AE02 Green 1AE03 Varias carpinterías 4AE01 Runner</p> <p>Ref. <b>Expansores</b> Expansores de fijación</p>		

# Bisagras

				
Series cámara europea  Ref. <b>3224</b> Distanciador interno en perfil para bisagras tenax	Series cámara europea  Ref. <b>3232</b> Suplemento para freno inferior	Series cámara europea  Ref. <b>5003</b> Suplemento hoja y marco resalte.	Series cámara europea  Ref. <b>1GC02D-I</b> Bisagra montada der-izq	Green Keeper 61-68 Keeper 45  Ref. <b>1GC35</b> Bisagra tenax dos palas desiguales para acople plano
				
Green Keeper 61-68 Keeper 45  Ref. <b>1GC55</b> Bisagra tenax apertura exterior dos palas iguales para acople plano	Keeper 61-68 Green  Ref. <b>1GC70</b> Bisagra tenax apertura exterior dos palas iguales para acople plano <b>*Consultar stock</b>	Series cámara europea  Ref. <b>1GC75</b> Bisagra inferior freno	Series cámara europea  Ref. <b>1GC85</b> Bisagra BRIDGE 1GC85	Series cámara europea  Ref. <b>1GC1410</b> Conjunto bisagra hoja pasiva oscilo batiente
				
Series cámara europea  Ref. <b>1GC1362</b> Bisagra 3ª hoja reversible	Series cámara europea  Ref. <b>1GC1397</b> Bisagra BRIDGE 3ª hoja	Green Euro-Keeper 45  Ref. <b>1GC29H-V</b> Juego de pivotes H Horizontal V Vertical	Euro mallorquina Plegable Garden  Ref. <b>30B05</b> Bisagra reversible 30B05	Euro mallorquina Plegable Garden  Ref. <b>30B06</b> Bisagra reversible 30B06
				
Series cámara europea  Ref. <b>90CEO</b> Bisagra reforzada dos palas	Europorticón  Ref. <b>81B01</b> Bisagra europorticón.	Wood  Ref. <b>M23626</b> Bisagra intermedia.	Euro mallorquina  Ref. <b>B4H</b> Bisagra 4ª hoja con eje distanciado	

				
Practicable tradicional	Practicable tradicional	Practicable tradicional	Practicable tradicional	
Ref. <b>9085</b> Bisagra 9085 para freno	Ref. <b>9086</b> Bisagra 9086 derecha Bisagra 9086 izquierda	Ref. <b>9087</b> Bisagra vaiven 9087	Ref. <b>9088</b> Bisagra vaiven 9088 para freno	



Universal

Ref. **7300**  
Freno MAB 7300









Fresas













				
Fresas	Green	Green	Green	Euro-keeper 45
Ref. <b>9901</b> Eje porta fresas	Ref. <b>9FR01</b> Fresas travesaño Green-Keeper	Ref. <b>9FR25</b> Fresas marco Euro-Keeper	Ref. <b>9FR26</b> Fresas hoja Euro-Keeper	Ref. <b>9FR27</b> Fresas travesaño vidrio directo Euro-Keeper
				
Keeper 61-68	Euro 40	Wood		
Ref. <b>9FR30</b> Fresas travesaño marco	Ref. <b>9FR40</b> Fresas travesaño Euro 40	Ref. <b>9FR45</b> Fresas travesaño hoja Wood		

# Cremonas

<p>Practicable tradicional</p> <p>Ref. <b>2080</b> Manubrio 2080</p>	<p>Serie cámara europea</p> <p>Ref. <b>1GR89</b> Base cremona oscilo batiente <b>*Consultar</b></p>	<p>Serie cámara europea</p> <p>Ref. <b>1GR90</b> Base cremona practicable <b>*Consultar</b></p>	<p>Serie cámara europea</p> <p>Ref. <b>1GR91</b> Maneta desmontable <b>*Consultar</b></p>	<p>Serie cámara europea</p> <p>Ref. <b>1GR92</b> Cremona practicable con llave.</p>
<p>Serie cámara europea</p> <p>Ref. <b>1GR93</b> Cremona oscilo con llave</p>	<p>Plegable Garden</p> <p>Ref. <b>13M30</b> Manubrio 13M30</p>	<p>Serie cámara europea</p> <p>Samblex 40i</p> <p>Ref. <b>1GM18</b> Cremona presión pivotante</p>	<p>Plegable Garden</p> <p>Euromallorquina</p> <p>Ref. <b>9800001</b> Maneta Slitta</p>	<p>Serie cámara europea</p> <p>Ref. <b>1GM1142</b> Cremona practicable Máxima Disponible en blanco y en negro</p>
<p>Serie cámara europea</p> <p>Ref. <b>1GM1146</b> Cremona apertura exterior. Disponible en blanco y en negro.</p>	<p>Serie cámara europea</p> <p>Ref. <b>1GR1144</b> Cremona oscilobatiente Maxima Disponible en blanco y en negro</p>	<p>Serie cámara europea</p> <p>Ref. <b>1GM14</b> Cremona practicable Globo Dispon. en oro, blanco y negro</p>	<p>Serie cámara europea</p> <p>Ref. <b>1GR27</b> Cremona oscilobatiente Globo Dispon. en oro, blanco y negro</p>	<p>P70CO Runner</p> <p>Ref. <b>1GM1651</b> Cremona para cierre multipunto en correderas (oro, blanco y negro)</p>
<p>P70CO Runner</p> <p>Ref. <b>1GM3050</b> Cremona para cierre multipunto en correderas</p>				











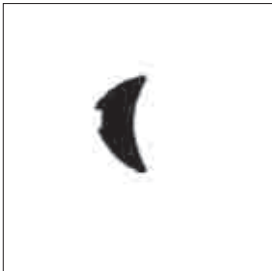
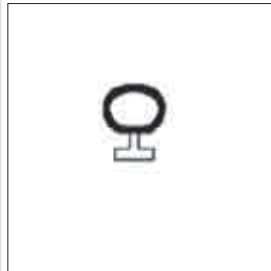
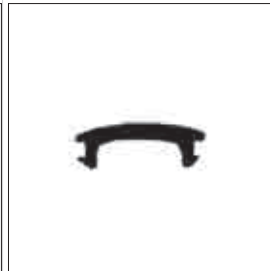
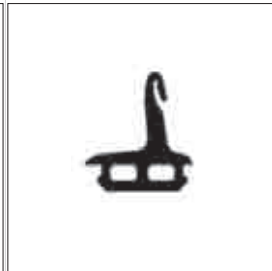

				
<p>Series cámara europea</p> <p>Ref <b>1GR02</b> Herraje oscilo batiente de 70 Kg</p>	<p>Series cámara europea</p> <p>Ref <b>1GR03</b> Herraje oscilo batiente 130 Kg</p>	<p>Series cámara europea</p> <p>Ref <b>1GR17</b> Compás oscilo batiente tipo 1</p>	<p>Series cámara europea</p> <p>Ref <b>1GR16</b> Compás oscilo batiente tipo 2</p>	<p>Series cámara europea</p> <p>Ref <b>1GR1843</b> Suplemento vertical / horizontal 1GR13</p>
				
<p>Series cámara europea</p> <p>Ref <b>1GR1846</b> Compás suplementario 1GR15</p>	<p>Series cámara europea</p> <p>Ref <b>1GD10</b> Compás basculante Inox</p>	<p>Series cámara europea</p> <p>Ref <b>1GD11</b> Compás basculante</p>	<p>Wood</p> <p>Ref <b>M52469</b> Compás basculante</p>	

				
Decor-Stil	Decor-Stil	Decor-Stil	Decor-Stil	Decor-Stil
Ref <b>R1</b> Reja decorativa 80 x 320 mm	Ref <b>R2</b> Reja decorativa 80 x 700 mm.	Ref <b>R3</b> Reja decorativa 80 x 1100 mm	Ref <b>R7</b> Reja decorativa 75 x 200 mm	Ref <b>R8</b> Reja decorativa 90 x 250 mm
				
Decor-Stil	Decor-Stil	Decor-Stil	Decor-Stil	Decor-Stil
Ref <b>R10</b> Reja decorativa 65 x 600 mm	Ref <b>A504</b> Florón	Ref <b>A507</b> Florón	Ref <b>A540</b> Terminal	Ref <b>A541</b> Terminal
				
Decor-Stil	Decor-Stil	Decor-Stil		
Ref <b>C201</b> Unión cruceta celosías	Ref <b>C202</b> Unión cruceta celosías	Ref <b>C203</b> Unión cruceta celosías		

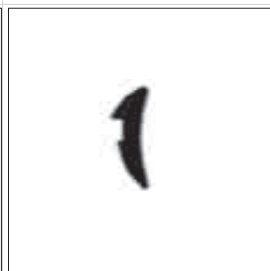
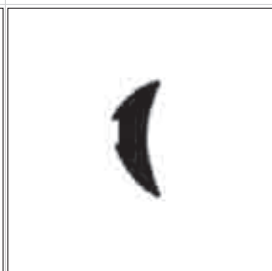
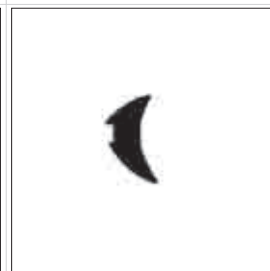
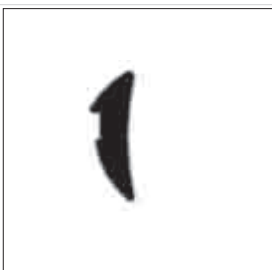

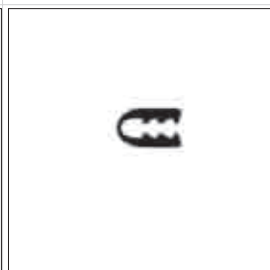

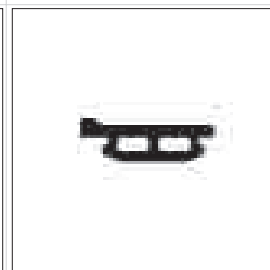

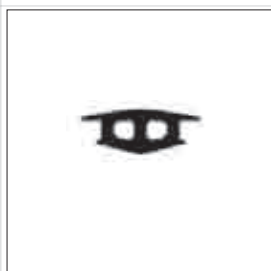
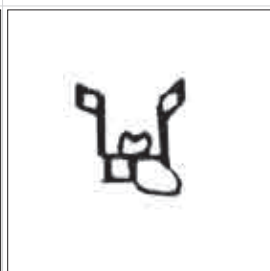
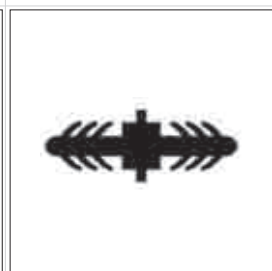
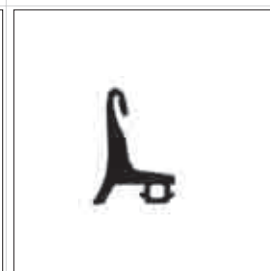









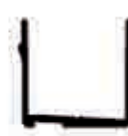

				
<p>Green Euro 40</p> <p>Ref. <b>1AG57</b> Unión travesaño 1AG57</p>	<p>Euro 40 Green</p> <p>Ref. <b>1AG58</b> Unión travesaño 1AG58</p>	<p>Green Euro-keeper 45</p> <p>Ref. <b>1AG91</b> Unión travesaño 1AG91</p>	<p>Euro 40 Euro-keeper 45</p> <p>Ref. <b>1MG60</b> Unión travesaño 1MG60</p>	<p>Green Keeper 61-68</p> <p>Ref. <b>2AG42</b> Unión travesaño 2AG42</p>
				
<p>Keeper 61-68</p> <p>Ref. <b>2AG43</b> Unión travesaño 2AG43</p>	<p>Wood</p> <p>Ref. <b>7AG01</b> Unión travesaño 7AG01</p>	<p>Divisiones oficina</p> <p>Ref. <b>10470</b> Unión mampara división oficinas</p>	<p>Serie Garden</p> <p>Ref. <b>04E21</b> Unión para marco 20373</p>	<p>Serie Garden</p> <p>Ref. <b>30E21</b> Unión complemento 04E21 para marco 20373</p>
				
<p>Ref. <b>4017-18</b> 4017 Unión pequeña 4018 Unión grande</p>				

# Tapas estanqueidad y grapas

				
Plegable Garden	Green	Green	Euro 40	Euro 40
Ref. <b>1AT01</b> Tapa estanqueidad	Ref. <b>1AT10</b> Tapa estanqueidad perfil 21633 apertura exterior	Ref. <b>1AT11</b> Tapa estanqueidad perfil 21633 apertura interior	Ref. <b>1AT19</b> Tapa para franja 24406	Ref. <b>1AT50</b> Tapa para perfil 27530.
				
Series cámara europea	Series cámara europea	Todas las practicables	Keeper 61-68	Keeper 61-68
Ref. <b>1AZ21</b> Inglete zamac junquillos canto redondo	Ref. <b>1AB48</b> Grapa junquillo curvo	Ref. <b>1GT90-15D01</b> Tapeta salida agua	Ref. <b>2AT11</b> Tapa estanqueidad	Ref. <b>2AT15</b> Tapa estanqueidad
				
Euro 40 Euro-keeper 45	Keeper 61-68	Green	Euro 40 Green Euro-keeper 45 Keeper 61-68	Runner
Ref. <b>2AT53</b> Tapa estanqueidad	Ref. <b>2AT67</b> Tapa estanqueidad	Ref. <b>3AT01</b> Tapa estanqueidad	Ref. <b>3AT32</b> Tapa estanqueidad vierteaguas	Ref. <b>4MT13</b> Estanqueidad adhesiva marco corte recto
				
Series cámara europea	Wood	Wood	Runner	Runner
Ref. <b>44660</b> Tapa inversor	Ref. <b>7AT01</b> Tapa estanqueidad	Ref. <b>7AV01</b> Grapa fijación junquillo.	Ref. <b>4MT12</b> Tapón	Ref. <b>4MT85</b> Tapa estanqueidad 4 hojas

				
Serie çámara europea	Serie çámara europea	Serie çámara europea	Green Keeper 61-68	Green Keeper 61-68
Ref <b>8005</b> Junta de acristalar interior - exteriormente de cuña 6 mm	Ref <b>8021</b> Junta de solape entre marco y hoja	Ref <b>8030</b> Junta de condensación en marcos	Ref <b>8031</b> Junta EPDM estanqueidad central	Ref <b>8032</b> Angulo EPDM sella e ingletado a 90°
				
Serie çámara europea	Serie çámara europea	Serie çámara europea	Serie çámara europea	Serie çámara europea
Ref <b>8033</b> Junta de solape entre marco y hoja	Ref <b>8034</b> Junta de acristalar exteriormente guiadas 3 mm	Ref <b>8035</b> Junta de acristalar interior - exteriormente de cuña 2 mm	Ref <b>8036</b> Junta de acristalar interior - exteriormente de cuña 3 mm	Ref <b>8037</b> Junta de acristalar interior - exteriormente de cuña 4 mm
				
Serie çámara europea	Green Keeper 61-68	Wall	Open Green	Open Green
Ref <b>8038</b> Junta de acristalar interior - exteriormente de cuña 5 mm	Ref <b>8039</b> Junta de estanqueidad para acoplamiento pivotantes	Ref <b>8040</b> Junta de dilatación de montantes	Ref <b>8042</b> Junta de solape	Ref <b>8043</b> Junta tapa
				
Green Keeper 61-68	8031 Green / Keeper 61-68 4GT72 Runner 8053 Euro-Keeper 45 8055 Euro 40 DD67 P70CO	Euro-keeper 45	Euro-keeper 45	Euro-Keeper 45
Ref <b>8044</b> Junta de dilatación de montantes	Ref <b>8045</b> Junta de dilatación de montantes	Ref <b>8048</b> Junta de estanqueidad para acoplamiento pivotantes	Ref <b>8050</b> Junta de dilatación	Ref <b>8053</b> Junta EPDM estanqueidad central

# Juntas y gomas

				
Euro-Keeper 45	Euro 40	Euro-Keeper 45	Euro 40	Green Keeper 61-68
Ref. <b>8054</b> Junta de condensación en marcos	Ref. <b>8055</b> Junta EPDM estanqueidad central	Ref. <b>8056</b> Angulo EPDM sella e ingletado a 90°	Ref. <b>8057</b> Angulo EPDM sella e ingletado a 90°	Ref. <b>8064</b> Junta de condensación en marcos
				
Goma	Euro-Keeper 45 Keeper 61-68	Green keeper 61-68	Wood	Wood
Ref. <b>8066</b> Remate inferior zócalos	Ref. <b>8067</b> Junta de aislamiento	Ref. <b>8090</b> Goma abertura exterior	Ref. <b>8230</b> Junta térmica marco	Ref. <b>8233</b> Junta hoja
				
Open Green Keeper	Runner 61 - 68		Runner 61 - 68	Runner 61 - 68
Ref. <b>8442</b> Junta solape puerta	Ref. <b>4GT71</b> Junta aislamiento marco	Ref. <b>4GT72</b> Poliamida cruce	Ref. <b>4GT73</b> Guarnición de vidrio	Ref. <b>4GT74</b> Junta marco recto
				
Runner	P 70 P 70 tt	Plegable garden	Plegable garden	mallorquina
Ref. <b>4GT75</b> Junta para perfil 21985	Ref. <b>90G14</b> Goma de vidrio	Ref. <b>90G59</b> Goma interior cuña	Ref. <b>90G75</b> Goma exterior	Ref. <b>90G97</b> Goma vertical garden

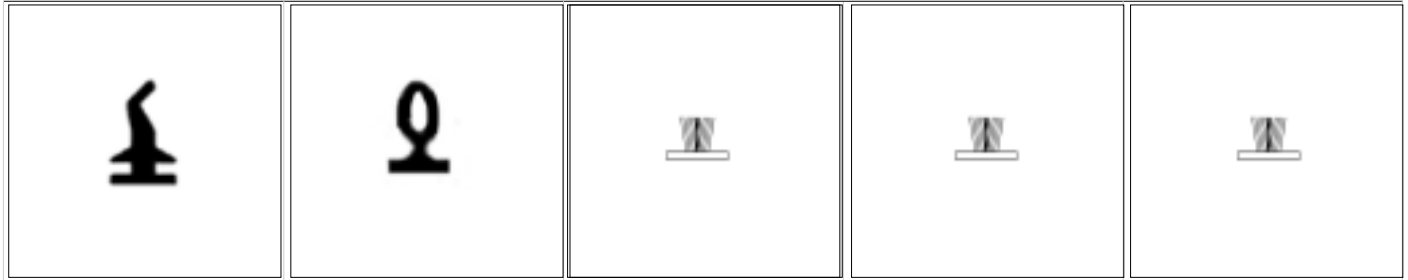

plegable garden	P 70	7 x 5 S 72 6 x 5,3 S 62 7 x 5,5 P 70 7 x 5,5 Runner 7 x 8 P 70 6 x 6,5 S 72 6 x 4,8 S 62 3 x 13 Plegable	6,5 x 4,8 Itesal 7 x 6 P 70 TT 6,5 x 5,3 Itesal 3,8 x 5 Green 5 x 6 Itesal 4,8 x 11 Green 7 x 7,5 P 70 TT 6,9 x 5,5 Runner	5 x 6 Guia p 7 x 8 5 x 8 Guia p 6 x 5 Vitrina 23 x 10 Cortav. 6,9 x 5,5 Runner TT
Ref. <b>90G99</b> Goma central	Ref. <b>DD67</b> Goma cruce P 70	Ref. <b>Cepillos</b> Cepillos con lámina de plástico	Ref. <b>Cepillos</b> Cepillos con lámina de plástico	Ref. <b>Cepillos</b> Cepillos sin lámina de plástico

## Cerraduras



Series cámara europea	Series cámara europea	Series cámara europea	Series cámara europea	Series cámara europea
Ref. <b>11C02</b> Medio cilindro.	Ref. <b>13C08</b> Encuentro sup/inf de 3 puntos. <b>*Consultar stock</b>	Ref. <b>13C09</b> Encuentro central. <b>*Consultar stock</b>	Ref. <b>13S28</b> Cerradura sup / inf 3 puntos <b>*Consultar stock</b>	Ref. <b>13S29</b> Cerradura vertical

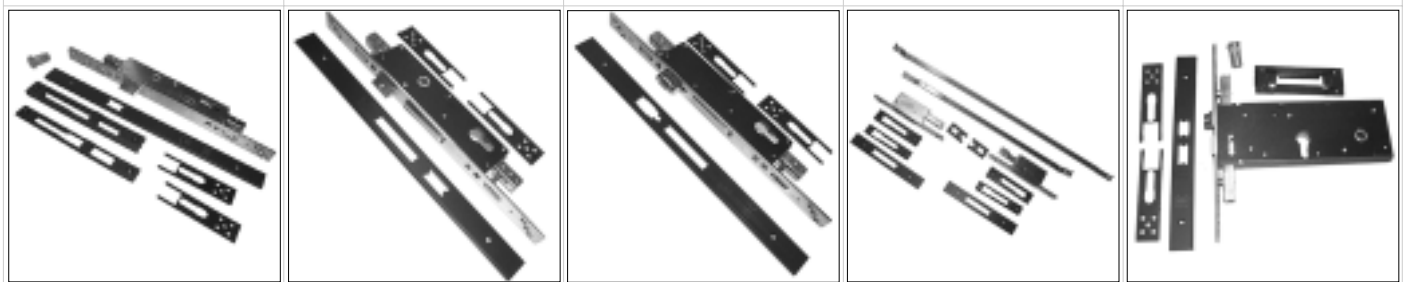









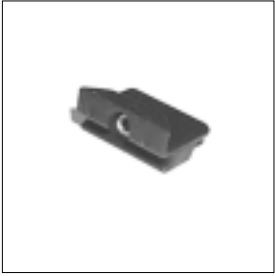
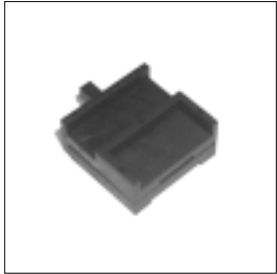

Series cámara europea	Series cámara europea	Series cámara europea	Series cámara europea	Series cámara europea
Ref. <b>13S30</b> Cerradura	Ref. <b>13S31</b> Cerradura central 3 puntos <b>*Consultar stock</b>	Ref. <b>13S34</b> Cerradura	Ref. <b>13S52</b> Cerradura	Ref. <b>13S55</b> Cerradura

# Cerraduras, cierres y tiradores

Euro mallorquina (2517) Plegable Garden  Ref. <b>30S01</b> Cerradura para llave cruz (sin bombin)	Euro mallorquina (2517) Plegable Garden  Ref. <b>30S02</b> Cerradura para llave de bombin	Series cámara europea  Ref. <b>46525</b> Cerradura de 3 puntos sin cilindro. <b>*Consultar stock</b>	Series cámara europea  Ref. <b>80S13</b> Cerradura golpe y llave	Series cámara europea  Ref. <b>80S14</b> Bombin de 54 mm centrado 22 + 10 + 22
Series cámara europea  Ref. <b>80S15</b> Bombin de 66 mm descentrado 22 + 10 + 34	Universal  Ref. <b>80S16</b> Bombin de 60 mm descentrado 22 + 10 + 28	Universal  Ref. <b>80S20</b> Bombin de 60 mm descentrado 22 + 10 + 28	Universal  Ref. <b>80S21</b> Bombin de 54 mm centrado 22 + 10 + 22	Universal  Ref. <b>80S22</b> Bombin de 66 mm 22 + 10 + 34
Series cámara europea  Ref. <b>80S36</b> Cerradura	Series cámara europea  Ref. <b>80S41-42</b> Cerradura eléctrica	Euro 40 Green  Ref. <b>8999917-18</b> Llave de recambio D - I	Guia vitrina  Ref. <b>P30</b> Cierre de vitrina P30	Guia vitrina  Ref. <b>AGA155</b> Cierre de vitrina AGA 155
Series cámara europea  Ref. <b>1GM26 + 1011</b> 1GM26 -> Kit abertura exterior 1011 -> Bulon	Series cámara europea  Ref. <b>1GM35</b> Piezas ensamble pletina cremona	Series cámara europea  Ref. <b>1GM36</b> Terminal pletina cremona	Series cámara europea  Ref. <b>13D19</b> Encuentro terminal cremona	Series cámara europea  Ref. <b>M23705</b> Dedal metálico

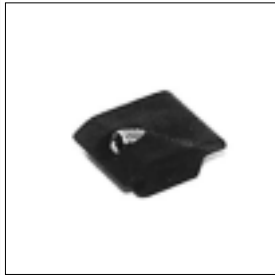
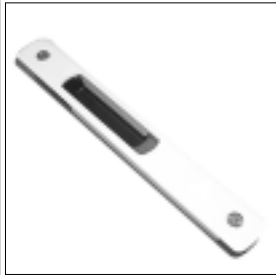

				
Series cámara europea  Ref. <b>1GD06</b> Cierre golpete basculante	Series cámara europea  Ref. <b>1GD30</b> Bulón excéntrico	Series cámara europea  Ref. <b>1GD43</b> Encuentro 3er punto de cierre		
Cierres y tiradores				
				
Euro mallorquina Plegable Garden  Ref. <b>30D03</b> Piezas conexión pletina/varillas con cremona	Euro mallorquina Plegable Garden  Ref. <b>30D10</b> Terminal varilla	Euro mallorquina Plegable Garden  Ref. <b>30D15</b> Cierre de varillas	Euro mallorquina Plegable Garden  Ref. <b>30M16</b> Uñero tirador	Europorticon  Ref. <b>3030</b> Manilla europorticon.
				
Series cámara europea  Ref. <b>13D12</b> Pasador puerta superpuesto	Series cámara europea  Ref. <b>13D13</b> Pasador puerta guiado	Series cámara europea  Ref. <b>1GM31</b> Resbalón de apoyo hoja	S-72 S-62 Runner P70 / P70 TT Ref. <b>9500010</b> Cierre alfa	S-62  Ref. <b>CM62</b> Cierre manual S-62

# Cierres y tiradores

S-72 S-62 P70 / P 70 TT Runner *todas con cierre alfa Ref. <b>9500013</b> Tirador alfa	S-72 Runner P70 / P70 TT Ref. <b>9500014</b> Cierre alfa interior - exterior	Runner P 70 CO P 70 TT Ref. <b>9500028</b> Cierre con llave	Runner P 70 CO P 70 TT Ref. <b>9500029</b> Cierre con asa y llave	Runner P 70 CO P 70 TT Ref. <b>9500030</b> Cierre con uñero y llave
Runner Ref. <b>4MM04-05</b> Cierre embutido	P 70 CO / Runner / P70 TT Ref. <b>4MM65-66-67</b> Cierre multipunto 65 -> 1,80 mts    66 -> 1 mt    67 -> 60 cms		S-72 Ref. <b>9500011</b> Kit gancho cierre alfa S-72	P 70 CO Runner Ref. <b>9500012</b> Kit gancho alfa P 70 CO y Runner
S-72 Ref. <b>9500016</b> Kit gancho cierre S-62	Runner Ref. <b>4MM10</b> Kit gancho cierre Medal Runner	Series cámara europea Ref. <b>13S08</b> Encuentro cerradura	Series cámara europea Ref. <b>13S09</b> Encuentro cerradura	Series cámara europea Ref. <b>3001</b> Kit cierre una hoja
Series cámara europea Ref. <b>3002</b> Kit cierre dos hojas	Series cámara europea Ref. <b>3009</b> Kit cierre segunda hoja	P 70 tt Ref. <b>9508008</b> Calzo multipunto	P 70 CO Ref. <b>9508009</b> Calzo multipunto	Series cámara europea Ref. <b>1GP1768</b> Juego passador 2ª hoja

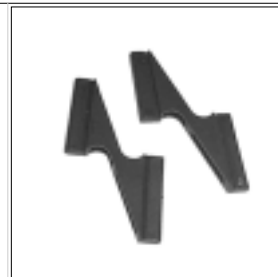

S662506 - 6 lamas	S662510 - 10 lamas	<b>S662514 - 14 lamas</b>	S662518 - 18 lamas	S662522 - 22 lamas	S662526 - 26 lamas	S662530 - 30 lamas
S662507 - 7 lamas	S662511 - 11 lamas	S662515 - 15 lamas	S662519 - 19 lamas	S662523 - 23 lamas	S662527 - 27 lamas	S662531 - 31 lamas
S662508 - 8 lamas	S662512 - 12 lamas	<b>S662516 - 16 lamas</b>	S662520 - 20 lamas	S662524 - 24 lamas	S662528 - 28 lamas	S662532 - 32 lamas
S662509 - 9 lamas	S662513 - 13 lamas	<b>S662517 - 17 lamas</b>	S662521 - 21 lamas	S662525 - 25 lamas	S662529 - 29 lamas	S662533 - 33 lamas

Euro Mallorca

**Mecanismos lama movil**  
Mecanismos de accionamiento de lama movil en Euro Mallorca

**Ref. 6BS00**  
Pieza soporte lama fija



Euro Mallorca



Euro Mallorca



Euro Mallorca



Euro Mallorca

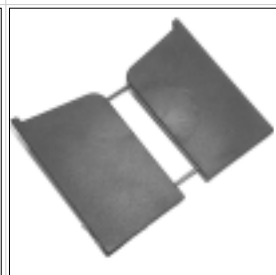

Euro Mallorca

**Ref. 6BS10**  
Piezas inicio / final de lama fija

**Ref. Ropo24**  
Pomo accionamiento lamas

**Ref. 9800001**  
Tirador accionamiento lamas

**Ref. Soporte pared autom.**  
Soporte pared automático, para mallorquina practicable

**Ref. 30D30**  
Tapetas perfil corredera corredera de peso suspendido



Euro Mallorca

**Ref. 30M12**  
Cierre empotrado 2 hojas

## Accesorios varios



Green  
Euro 40

**Ref. 1RG01**  
Rodillo de guia / presión en junta central



perfiles lacados

**Ref. 8500052**  
Limpiador para perfiles lacados



Maquinas de corte

**Ref. 8500075**  
Bidón de aceite lubricante



perfiles lacados

**Ref. 8500049**  
Stick reparador (varios colores)



perfiles y accesorios













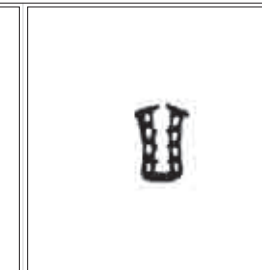
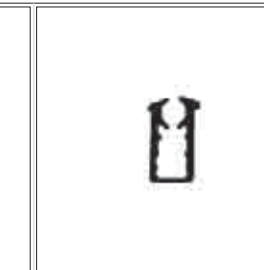



**Ref.**  
Spray de pintura (varios colores)









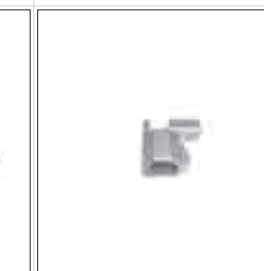











Guia vitrina	Guia vitrina	P70CO	P70CO	S-72
Ref. <b>R31</b> Rueda R31 para vidrio de 5 - 6 mm	Ref. <b>R45</b> Rueda R45 + tope para vidrio de 8 mm.	Ref. <b>11R70</b> Conjunto 4 ruedas regulables de aguja (80 kgs por hoja)	Ref. <b>11R71</b> Conjunto 4 ruedas regulables de aguja (40 kgs por hoja)	Ref. <b>RAA72</b> Rueda regulable de agujas (80Kgs por hoja)
S-62	S-72	S-72	P70 CO	S-72
Ref. <b>RRT62</b> Rueda regulable de agujas (80 Kgs por hoja)	Ref. <b>RR72</b> Rueda regulable (40 Kgrs por hoja).	Ref. <b>RR72M</b> Rueda tandem (120Kgs por hoja)	Ref. <b>RT70M</b> Rueda tandem (120 Kgrs por hoja)	Ref. <b>RT72R</b> Rueda tandem (120 Kgs por hoja)
Euro mallorquina Plegable Garden	Euro mallorquina Plegable Garden	Euro mallorquina Plegable Garden	Euro mallorquina Plegable Garden	P70CO
Ref. <b>30R01</b> Conjunto ruedas / bisagra para plegable de 2 palas	Ref. <b>30R02</b> Conjunto ruedas / bisagra para plegable de 1 pala	Ref. <b>30R10-11</b> 30R10 Tope guia superior 30R11 Guia inferior	Ref. <b>30R12</b> Ruedas carril superior	Ref. <b>11G70-71</b> 11G70 Kit estanqueid. hoja gran. 11G71 Kit estanqueid. hoja peq.
S-62	S-72	Runner Runner TT	Runner Runner TT	P 70 CO TT
Ref. <b>11G62</b> Kit cortavientos - tapetas para dos / cuatro hojas	Ref. <b>11G72</b> Kit cortavientos - tapetas para dos / cuatro hojas	Ref. <b>4MT30</b> Kit cortavientos	Ref. <b>4MK74</b> Kit ruedas y tapas	Ref. <b>74055</b> Kit estanqueidad y rodamientos

# Barandilla Mixta

Barandilla mixta  Ref. <b>E-2</b> Prolongación barandilla E-2	Barandilla mixta  Ref. <b>B12803</b> Bisagra articulada B12803	Barandilla mixta  Ref. <b>E-8</b> Tapa base E-8	Barandilla mixta  Ref. <b>7200010</b> Soporte vertical	Barandilla mixta  Ref. <b>7200026</b> Soporte recto
Barandilla mixta  Ref. <b>T12801</b> Tapeta lateral perfil 12801	Barandilla mixta  Ref. <b>T12802D-I</b> Tapeta perfil 12802 D (dx)	Barandilla mixta  Ref. <b>T12804</b> Tapeta lateral perfil 12804	Barandilla mixta  Ref. <b>T12807</b> Tapeta perfil 12807	Barandilla mixta  Ref. <b>T12808</b> Tapeta perfil 12808
Barandilla mixta  Ref. <b>7200050</b> Base anclaje fundición	Barandilla mixta  Ref. <b>SP12803</b> Soporte pared 12803-12804	Barandilla mixta  Ref. <b>7212727</b> Tornillo perfil pilastra 12727	Barandilla mixta  Ref. <b>E12803</b> Escuadra 90° para perfiles 12803 y 12804	Barandilla mixta  Ref. <b>AB-6</b> Pletina i unión perpendicular





















# Accesorios HORIZONTAL

				
Ariane	Ariane	Ariane	Athys 3 Vallees	Athys 3 Vallees
Ref. <b>1760200</b> Soporte Ariane 200 mm	Ref. <b>1760400</b> Soporte Ariane 400 mm	Ref. <b>1760600</b> Soporte Ariane 600 mm.	Ref. <b>DJP25</b> Junta EPDM para chapa 2 - 3 mm.	Ref. <b>DJP66</b> Junta EPDM acristalamiento de 3 + 3 mm
				
Athys 3 Vallees	Ranch	Ranch	Ranch	Ranch
Ref. <b>DJP88</b> Junta EPDM acristalamiento 4 + 4 mm.	Ref. <b>FB226</b> Unión interior pasamano superior e inferior modelo Ranch	Ref. <b>FB601</b> Brida fijación pasamano inferior rigidizador modelo RANCH recto	Ref. <b>FB602</b> Soporte articulado para pasamano RANCH tramo inclinado	Ref. <b>FB603</b> Soporte combinado con FB602 para pasamano RANCH
				
Ranch	Ranch	Ranch	Ranch	Ranch
Ref. <b>FB604</b> Brida fijación pasamano inferior / intermedio, tramo RANCH en inclinado	Ref. <b>FB607</b> Soporte fijación pared pasamano superior / inferior modelo RANCH	Ref. <b>FB609D-I</b> Tapetas laterales perfil pasamano inferior RANCH	Ref. <b>FB611</b> Codo 90° fijo perfil pasamano superior modelo RANCH	Ref. <b>FB612</b> Codo 90° fijo perfil pasamano inferior modelo RANCH
				
Ranch	Ranch	Ranch	Ranch	Ranch
Ref. <b>FB615</b> Unión articulada vertical para pasamano superior / inferior modelo RANCH	Ref. <b>FB616</b> Unión articulada horizontal para pasamano superior / inferior modelo RANCH	Ref. <b>FB666D-I</b> Codo 90° articulado en bajada/ subida, pasamano superior modelo RANCH	Ref. <b>FB667D-I</b> Codo 90° articulado subida / bajada, pasamano superior modelo RANCH	Ref. <b>FB670</b> Soporte superior pasamano modelo RANCH. Tramo recto.



















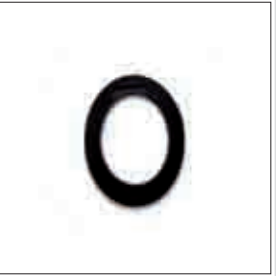

				
Ranch  Ref. <b>FB674</b> Soporte superior modelo RANCH.	Ranch  Ref. <b>FB715Z</b> Tapa pasamano superior modelo RANCH con hueco.	Ranch  Ref. <b>FB718Z</b> Tapeta lateral pasamano superior modelo RANCH sin hueco.	Fijaciones pilastras  Ref. <b>FM12</b> Conjunto tornillo métrico 12 x 90 y taco metálico.	Fijaciones a pared  Ref. <b>FM8</b> Conjunto tornillo métrico 8 x 20 y taco metálico.
				
Athys 3 Vallees Antares  Ref. <b>HO040</b> Perfil largo pasamano modelos ATHYS, 3 VALLEES y ANTARES.	Athys 3 Vallees Antares  Ref. <b>HO041</b> Escuadra 90° perfil pasamano superior modelos ATHYS, 3 VALLEES y ANTARES.	Combinación con R819  Ref. <b>HO049</b> Conjunto base anclaje para fijación frontal a forjado	Athys 3 Vallees Antares Ranch  Ref. <b>HO095D-I</b> Soporte fijación a pared pasamano ATHYS, 3 VALLEES y ANTARES.	Athys 3 Vallees Antares  Ref. <b>HO105D-I</b> Soporte fijación a pared pasamano
				
3 Vallees  Ref. <b>HO108D-I</b> Soporte fijación a pared perfiles R666 y R667	Athys 3 Vallees Antares  Ref. <b>HO110</b> Escuadra articulada para pasamano	3 Vallees  Ref. <b>HO112D-I</b> Tapeta lateral perfiles R666 y R667	3 Vallees ATHYS  Ref. <b>HO114</b> Tapeta para pasamano R758.	Athys 3 Vallees Antares Ranch  Ref. <b>HO1201</b> Spal fijación altura 980 mm. <b>*A sustituir por HO610Z</b>
				
3 Vallees  Ref. <b>HO136</b> Escuadra articulada vertical.	Separaciones balcón  Ref. <b>HO140</b> Conjunto mordaza para vidrio de mampara separación de balcón.	Separaciones balcón  Ref. <b>HO142</b> Refuerzo de la mordaza HO140. <b>* Consultar</b>	Ranch  Ref. <b>HO146</b> Pieza fijación pasamano desplazado sobre R819.	Ranch 3 Vallees Athys  Ref. <b>HO148</b> Tapeta final pilastra R819.























# Accesorios HORIZONTAL

				
Ranch 3 Vallees Athys  Ref. <b>HO147 + HO165</b> Conjunto fijación pasamano a pilastra en tramos inclinados, modelos ATHYS y 3 VALLEES.	Athys 3 Vallees Antares  Ref. <b>HO169D-I</b> Fijación pared perfil R666 y R667.	Athys 3 Vallees Antares  Ref. <b>HO178</b> Pieza soporte pasamano a pilastra, modelos ATHYS, 3 VALLEES y ANTARES.	Athys 3 Vallees Antares Ranch  Ref. <b>HO202</b> Spal fijación a suelo altura 1080 mm. <b>* A sustituir por HO611Z</b>	Athys 3 Vallees Antares Ranch  Ref. <b>HO205</b> Base para regular Spal 1201 o HO604Z
				
Athys  Ref. <b>HO217</b> Spal L200-45, fijación frontal a murete. <b>* Consultar</b>	Athys 3 Vallees Antares Ranch  Ref. <b>HO229 + HO205</b> Base y soporte para fijación sobre forjado de pilastra R819. <b>* Consultar</b>	Antares  Ref. <b>HO292</b> Brida fijación inferior de modelo ANTARES	Athys 3 Vallees Antares  Ref. <b>HO354D-I</b> Soporte fijación articulado a pared de pasamano	3 Vallees Antares  Ref. <b>HO355D-I</b> Soporte fijación articulado a pared de perfiles R666 y R667
				
Exclusivamente para R460  Ref. <b>HO358</b> Codo 90° pasamano R460	Exclusivamente para R460  Ref. <b>HO360</b> Tapeta lateral pasamano R460	Exclusivamente para R460  Ref. <b>HO364</b> Tapeta lateral pasamano R460	Athys  Ref. <b>HO400</b> Soporte frontal a pared de pasamano R460	Exclusivamente para R460  Ref. <b>HO402</b> Codo articulado graduable de 80° a 137° en pasamano R460
				
Exclusivamente para R460  Ref. <b>HO407</b> Codo articulado graduable de 133° a 180° en pasamano R460	Athys 3 Vallees  Ref. <b>HO419Z</b> Base y soporte para fijación sobre forjado de pilastra R819	Exclusivamente para R560  Ref. <b>HO469D-I</b> Tapeta lateral pasamano	3 Vallees  Ref. <b>HO544</b> Codo 90° para perfiles R666 y R667	3 Vallees  Ref. <b>HO552</b> Escuadra 90° canto redondo para perfiles R666 y R667



				
Athys	Athys 3 Vallees Antares Ranch	Athys	Athys 3 Vallees Antares Ranch	Athys 3 Vallees Antares Ranch
Ref: <b>HO555</b> Brida fijación perfiles RN30 y R630	Ref: <b>HO604Z</b> Base fijación frontal a forjado	Ref: <b>HO606</b> Conjunto unión alargó perfil R630	Ref: <b>HO610Z</b> Spal con tapeta altura 980 mm. para fijación sobre forjado	Ref: <b>HO611Z</b> Spal con tapeta altura 1080 mm. sobre forjado
				
Athys 3 Vallees Antares Ranch	Fijaciones pilastras	Exclusivamente para R620	Ariane	Exclusivamente para R638
Ref: <b>HO612Z</b> Base y soporte con tapeta para fijación sobre forjado de pilastra R819	Ref: <b>HO613</b> Base regulación Spal HO610Z - HO611Z o soportes HO604Z - HO612Z y HO419Z.	Ref: <b>HO620D-I</b> Tapeta lateral pasamano	Ref: <b>HO630</b> Base para soporte fijación frontal HO804	Ref: <b>HO638D-I</b> Tapeta lateral perfiles
				
3 Vallees Antares	3 Vallees Antares	3 Vallees Antares	Ariane	Ariane
Ref: <b>HO642</b> Accesorio unión alargó perfiles R638, R666 y R667	Ref: <b>HO643</b> Codo 90° para perfiles R638, R666 y R667	Ref: <b>HO644</b> Codo articulado para perfiles R638, R666 y R667	Ref: <b>HO649</b> Base regulación soporte HO650	Ref: <b>HO650</b> Base fijación sobre murete
				
Athys	Athys 3 Vallees	Athys 3 Vallees	Athys	Athys Ariane
Ref: <b>HO655+HO656</b> Conjunto brida articulada fijación R630 y RN30 a pilastra	Ref: <b>HO692</b> Roseta central cruz San Andres	Ref: <b>HO693+HOC60</b> Conjunto fijación Cruz de San Andres perfiles R630	Ref: <b>HO693+HO694</b> Conjunto fijación Cruz de San Andrés a perfiles R666 y R667	Ref: <b>HO7001</b> Codo 90° perfiles R630 y RN30

# Accesorios HORIZONTAL

				
Athys Ariane  Ref. <b>HO705</b> Soporte fijación a pared perfiles RN30 y R630	Athys Ariane  Ref. <b>HO706</b> Unión interior alargó perfil RN30	Athys Ariane  Ref. <b>HO708</b> Tapeta perfiles RN30 y R630	Ariane  Ref. <b>HO710</b> Fijación pared perfil RN30	Athys 3 Vallees Antares  Ref. <b>HO740D-I</b> Tapeta lateral pasamano perfiles R720 y R740
				
Athys Ariane  Ref. <b>HO743</b> Codo 90° fijo para perfil RN30	Athys Ariane  Ref. <b>HO744</b> Codo articulado para perfil RN30	Ariane  Ref. <b>HO756</b> Placa fijación tubo RN30 a pilastra en Ariane	Ariane  Ref. <b>HO778</b> Unión fijación pilastra a pasamano R460 en Ariane	Athys Ariane  Ref. <b>HO802</b> Codo articulado de 117° a 152° para perfiles RN30 y R630
				
Athys Ariane  Ref. <b>HO803</b> Codo articulado de 152° a 178° para perfiles RN30 y R630	Athys Antares 3 Vallees Ranch  Ref. <b>HO819</b> Terminal superior perfil rigidizador R819	Athys Ariane  Ref. <b>HO843</b> Codo 90° para perfil R630	Athys Ariane  Ref. <b>HO844</b> Codo articulado para perfil R630	3 Vallees Antares  Ref. <b>HO845</b> Codo articulado para perfil R630
				
Athys Ariane  Ref. <b>MH461</b> Unión alargó pasamano R460	Athys 3 Vallees Antares  Ref. <b>MH476</b> Unión alargó pasamano R560	Athys 3 Vallees Antares  Ref. <b>MH620</b> Unión alargó pasamano R620	Athys 3 Vallees Antares  Ref. <b>MH720</b> Unión alargó pasamano R720	Athys 3 Vallees Antares  Ref. <b>MH740</b> Unión alargó pasamano R740

				
Mallorquina oscura	Mallorquina oscura	Mallorquina oscura	Mallorquina oscura	Mallorquina oscura
Ref. <b>M14072</b> Bisagra central cruce	Ref. <b>M14094</b> Soporte pared fijo	Ref. <b>M14128</b> Terminal	Ref. <b>M14132</b> Terminal	Ref. <b>M14140</b> Eje soporte bisagra L=147 mm.
				
Mallorquina oscura	Mallorquina oscura	Mallorquina oscura	Mallorquina oscura	Mallorquina oscura
Ref. <b>M14144</b> Eje soporte bisagra L=172 mm.	Ref. <b>M14200</b> Conjunto maneta	Ref. <b>M14204</b> Conjunto maneta <b>*Consultar stock</b>	Ref. <b>M14248</b> Soporte fijación puerta	Ref. <b>M14360</b> Maneta pletina <b>*Consultar stock</b>
				
Mallorquina oscura	Mallorquina oscura	Mallorquina oscura	Mallorquina oscura	Mallorquina oscura
Ref. <b>M14376</b> Bisagra soporte fijación	Ref. <b>M14380</b> Bisagra soporte fijación	Ref. <b>M14416</b> Eje soporte bisagra L=145 mm.	Ref. <b>M14420</b> Eje soporte bisagra L=170 mm.	Ref. <b>M14474</b> Soporte pared fijación hoja
				
Mallorquina oscura	Mallorquina oscura	Mallorquina oscura	Mallorquina oscura	Mallorquina oscura
Ref. <b>M23705</b> Casquillo empotrado	Ref. <b>M41882</b> Espesor bisagra	Ref. <b>M42306</b> Taco para eje	Ref. <b>M42929</b> Tope cierre pared	Ref. <b>M43559</b> Tope cierre fijación















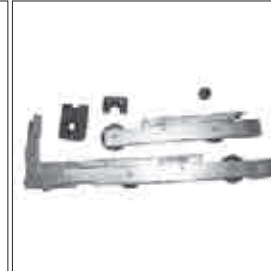





# Herrajes Mallorquina Oscura

Mallorquina oscura	Mallorquina oscura	Mallorquina oscura	Mallorquina oscura	Mallorquina oscura
Ref. <b>M43648</b> Guía varilla	Ref. <b>M52627</b> Plantilla bisagra	Ref. <b>M94101</b> Varilla accionamiento 2400 mm.	Ref. <b>M94126</b> Varilla accionamiento 1400 mm.	<b>M94134</b> Varilla accionamiento 2600 mm.
Mallorquina oscura	Mallorquina oscura	Mallorquina oscura	Mallorquina oscura	Mallorquina oscura
Ref. <b>44285</b> Varilla accionamiento 1600 mm.	Ref. <b>14210</b> Encuentro de cierre	Ref. <b>94148</b> Leva apoyo 2 hojas	Ref. <b>94151</b> Gancho para encuentro de cierre	Ref. <b>94153</b> Encuentro para cierre
Mallorquina oscura	Mallorquina oscura	Mallorquina oscura		
Ref. <b>94163</b> Gancho de cierre	Ref. <b>6BT00</b> Tapas acoplamiento central	Ref. <b>6BT30</b> Tapa terminal 21730		

# Herrajes Wood

Wood	Wood	Wood	Wood	Wood
Ref. <b>M10993 - 10538</b> Puntal terminal	Ref. <b>M34710 - 33607</b> Encuentro cierre acoplamiento central	Ref. <b>34943</b> Punto cierre bulon	Ref. <b>38754</b> Prolongador 1000 mm	Ref. <b>52321</b> Base bisagra intermedia hoja
Wood	Wood	Wood	Wood	Wood
Ref. <b>54132</b> Maneta plata practicable	Ref. <b>M22221 - M54556</b> Cierre basculante 500 - 700 mm.	Ref. <b>M22223 - M54558</b> Cierre basculante 1301- 1700mm.	Ref. <b>M11002 - 55877</b> Angulo reenvio especial oscilobatiente 280-650 mm.	Ref. <b>M52615 - 59469</b> Soporte superior / intermedia hoja
Wood	Wood	Wood	Wood	Wood
Ref. <b>M52616-17 - 59916-17</b> Bisagra inferior hoja Sx Bisagra inferior hoja Dc	Ref. <b>M43654 - 441520</b> Conjunto guia oscilo paralela L = 1960 mm	Ref. <b>M43655 - 441521</b> Conjunto guia oscilo paralela L = 2460 mm	Ref. <b>M43656 - 441522</b> Conjunto guia oscilo paralela L = 2960 mm	Ref. <b>M43657 - 441523</b> Conjunto guia oscilo paralela L = 3460 mm
Wood	Wood	Wood	Wood	Wood
Ref. <b>I990001 - 40SR50</b> Bloqueo cerradura	Ref. <b>M96460 - 96860</b> Cierre doble	Ref. <b>I12001 - I12011</b> Conjunto ángulos reenvio * Consultar plazo	Ref. <b>I12003</b> Conjunto ángulos reenvio * Consultar plazo	Ref. <b>I21926 - I52408</b> Accionamiento puerta H = 1850 - 2100 mm.

# Herrajes Wood

				
Wood	Wood	Wood	Wood	Wood
Ref. <b>I21927 - I52410</b> Accionamiento puerta H = 2100-2350 mm.	Ref. <b>I23829A - I52462A</b> Falso compás	Ref. <b>M10617 - I70620</b> Kit embellecedor bisagra Dx	Ref. <b>M10618 - I70621</b> Kit embellecedor bisagra Sx	Ref. <b>M10059</b> Conjunto rodamientos 250 kgs máximo hoja
				
Wood	Wood	Wood	Wood	Wood
Ref. <b>M10287</b> Maneta oro	Ref. <b>M10995 - M10587</b> Prolongación 400-600 mm.	Ref. <b>M10994 - M10585</b> Prolongación 250 mm.	Ref. <b>M10993 - M10795</b> Puntal terminal	Ref. <b>M11023</b> Plantilla accionamiento cremona
				
Wood	Wood	Wood	Wood	Wood
Ref. <b>M11325</b> Pernio de cierre en plata	Ref. <b>M21398</b> Plantilla encuentro cierres	Ref. <b>M22548</b> Passador 2º Hoja inferior	Ref. <b>M23626</b> Bisagra intermedia	Ref. <b>M23711 - M23731</b> Cierre pasador
				
Wood	Wood	Wood	Wood	Wood
Ref. <b>M24658</b> Maneta oscilo paralela	Ref. <b>M24897</b> Accionamiento cremona H = 600 - 800 mm.	Ref. <b>M29443 - M27687</b> Guía brazo complementario Longitud 230 - 600 mm	Ref. <b>M29444 - M27688</b> Guía brazo complementario Longitud 600 - 800 mm	Ref. <b>M29445 - M27689</b> Guía brazo complementario Longitud 800 -1050 mm





Wood

Wood

Wood

Wood

Wood

Ref. **M29446 - M27690**  
Guía brazo complementario  
Longitud 1050 - 1300 mm.

Ref. **M29447 - M27691**  
Guía brazo complementario  
Longitud 1300 - 1550 mm

Ref. **M27815**  
Cerradura elevable 730 - 800

Ref. **X49011 - M28576**  
Manilla

Ref. **M28597**  
Plantilla bisagra



Wood

Wood

Wood

Wood

Wood

Ref. **M28773**  
Guía deslizante posterior

Ref. **M28774**  
Guía deslizante posterior

Ref. **M30765**  
Cuadradillo cremona

Ref. **M33107 - M33932**  
Encuentro cierre oscilo inferior

Ref. **X49009 - M36415**  
Embellecedor maneta

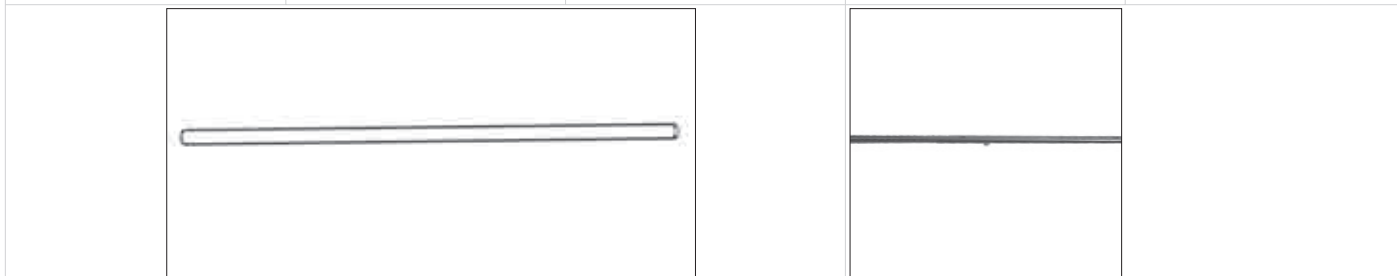

Wood

Wood

Wood

Wood

Ref. **M37647**  
Barra unión rodamiento  
Longitud 1,10 mts

Ref. **M37648**  
Barra unión rodamiento  
Longitud 1,60 mts

Ref. **M37649**  
Barra unión rodamiento  
Longitud 2,10 mts

Ref. **M39186**  
Alargo cerradura 1 mt.



Wood

Wood

Wood

Wood









Ref. **M41053**  
Conjunto tapeta ruedas O.P.  
L = 1150 mm

Ref. **M41057**  
Conjunto tapeta ruedas O.P.  
L = 1650 mm

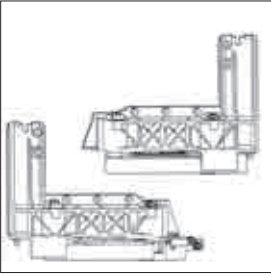
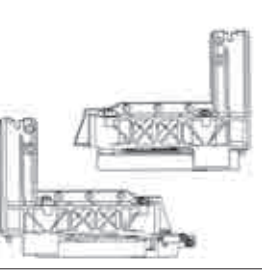



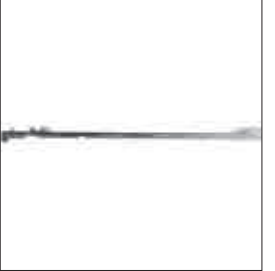

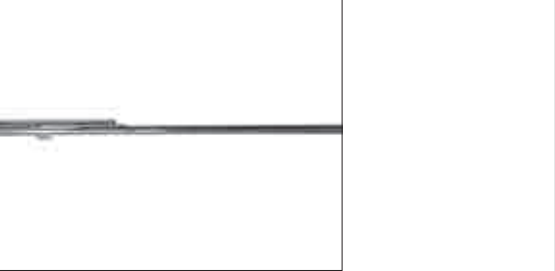







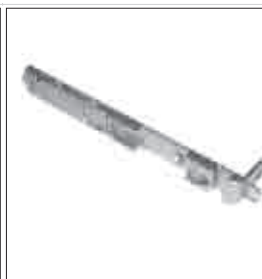

Ref. **M41263**  
Espesor para pasador

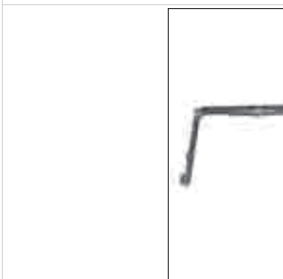
Ref. **M41985**  
Bloqueo accionamiento



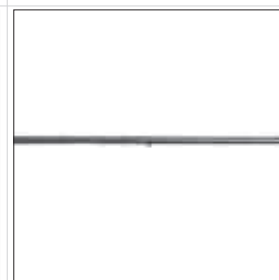





# Herrajes Wood

				
<p>Wood</p> <p>Ref: <b>M22402 - M42011</b> Cierre elevable 1,80 mts</p>	<p>Wood</p> <p>Ref: <b>M22403 - M42012</b> Cierre elevable 2 mts</p>	<p>Wood</p> <p>Ref: <b>M42098 - M42099</b> Embelledor bisagra intermedia marco</p>	<p>Wood</p> <p>Ref: <b>M42106 - M42107</b> Embelledor bisagra intermedia hoja</p>	<p>Wood</p> <p>Ref: <b>M43645</b> Conjunto carro O.P. Dx</p>
				
<p>Wood</p> <p>Ref: <b>M43646</b> Conjunto carro O.P. Sx</p>	<p>Wood</p> <p>Ref: <b>M40901 - M43883</b> Compas superior oscilo paralela</p>	<p>Wood</p> <p>Ref: <b>M50603 - M52401</b> Accionamiento cremona H = 431 - 680 mm</p>		
				
<p>Wood</p> <p>Ref: <b>M50606 - M52404</b> Accionamiento cremona H = 801 - 1000 mm</p>	<p>Wood</p> <p>Ref: <b>M50607 - M52405</b> Accionamiento cremona H = 1001 - 1250 mm</p>	<p>Wood</p> <p>Ref: <b>M50608 - M52406</b> Accionamiento cremona H = 1250 - 1500 mm</p>	<p>Wood</p> <p>Ref: <b>M50609 - M52407</b> Accionamiento cremona H = 1501 - 1750 mm</p>	<p>Wood</p> <p>Ref: <b>M50610 - M52408</b> Accionamiento cremona H = 1851 - 2100 mm</p>
				
<p>Wood</p> <p>Ref: <b>M50612 - M52410</b> Accionamiento cremona H = 2101 - 2350 mm</p>	<p>Wood</p> <p>Ref: <b>M29442 - M52443</b> Guía oscilobatiente L 280 - 429 mm</p>	<p>Wood</p> <p>Ref: <b>M29443 - M52444</b> Guía oscilobatiente L = 430 - 630 mm</p>	<p>Wood</p> <p>Ref: <b>M29444 - M52445</b> Guía oscilobatiente L = 601 - 800 mm</p>	<p>Wood</p> <p>Ref: <b>M29445 - M52446</b> Guía oscilobatiente L = 801 - 1050</p>



				
<p>Wood</p> <p>Ref. <b>M52447</b> Guía compás oscilo</p>	<p>Wood</p> <p>Ref. <b>M21985 - M52457</b> Cierre suplementario 1500 - 1750 mm.</p>	<p>Wood</p> <p>Ref. <b>M21986 - M52458</b> Cierre suplementario 1750 - 2350 mm.</p>	<p>Wood</p> <p>Ref. <b>M20990 - M52469</b> Cierre suplementario 1250-1500</p> <p>Ref. <b>M21913 - M52481</b> Bisagra marco superior / intermedia</p>	
				
<p>Wood</p> <p>Ref. <b>M21931 - M52484</b> Soporte inferior marco</p>	<p>Wood</p> <p>Ref. <b>M52488</b> Cierre suplementario. 1751-1950</p>	<p>Wood</p> <p>Ref. <b>M22548 - M52504</b> Pasador inferior 2ª hoja</p>	<p>Wood</p> <p>Ref. <b>M22962 - M52505</b> Pasador superior 2ª hoja</p>	<p>Wood</p> <p>Ref. <b>M11000 - M54592</b> Angulo reenvío oscilobatiente 280-650 mm.</p>
				
<p>Wood</p> <p>Ref. <b>M21982 - M54674</b> Cierre suplementario 750 - 1050 mm.</p>	<p>Wood</p> <p>Ref. <b>M21983 - M54675</b> Cierre suplementario 1050 - 1300 mm.</p>	<p>Wood</p> <p>Ref. <b>M21984 - M54676</b> Cierre suplementario 1250 - 1500 mm.</p>	<p>Wood</p> <p>Ref. <b>M28273 - M54944</b> Componente horizontal L = 530 mm</p>	<p>Wood</p> <p>Ref. <b>M28274 - M54945</b> Componente horizontal L = 790 mm</p>
				
<p>Wood</p> <p>Ref. <b>M28275 - M54946</b> Componente horizontal L = 1280 mm</p>	<p>Wood</p> <p>Ref. <b>M28276 - M54947</b> Componente altura posterior H = 1125 mm</p>	<p>Wood</p> <p>Ref. <b>M28277 - M54946</b> Componente altura posterior H = 1525 mm</p>	<p>Wood</p> <p>Ref. <b>M28278 - M54949</b> Componente altura posterior H = 2010 mm</p>	<p>Wood</p> <p>Ref. <b>M50611 - M55158</b> Accionamiento cremóna H = 1601 - 1850 mm</p>















# Herrajes Wood

				
<p>Wood</p> <p>Ref. <b>M10999 - M55907</b> Reenvlo oscilo 1 cierre</p>	<p>Wood</p> <p>Ref. <b>M28791 - M55987</b> Encuentro</p>	<p>Wood</p> <p>Ref. <b>M53562 - M56001</b> Cerradura H = 2400 mm</p>	<p>Wood</p> <p>Ref. <b>M94030</b> Soporte bisagra basculante</p>	<p>Wood</p> <p>Ref. <b>M38661 - M94491</b> Eje pasador para bisagra</p>
				
<p>Wood</p> <p>Ref. <b>M95013</b> Encuentro hoja</p>	<p>Wood</p> <p>Ref. <b>M34107 - M95113</b> Encuentro cierre marco</p>	<p>Wood</p> <p>Ref. <b>7GL13</b> Guarnición unión</p>		









# Accesorios Euro Runner 250tt



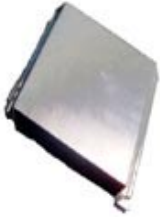















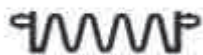

Euro Runner 250tt  Ref: <b>40GU01</b> Poliamida porta junta 40GU03	Euro Runner 250tt  Ref: <b>40GU02</b> Junta estanquidad guia superior	Euro Runner 250tt  Ref: <b>40GU03</b> Junta estanquidad hoja	Euro Runner 250tt  Ref: <b>40GU04</b> Junta estanquidad central marco lateral / superior	Euro Runner 250tt  Ref: <b>40GU05</b> Junta estanquidad hoja
Euro Runner 250tt  Ref: <b>40GU06</b> Junta estanquidad guia superior	Euro Runner 250tt  Ref: <b>D910065</b> Junta estanquidad	Euro Runner 250tt  Ref: <b>40TP01</b> Clip de fijación perfil cruce	Euro Runner 250tt  Ref: <b>40TP02</b> Puente estanquidad superior	Euro Runner 250tt  Ref: <b>40TP03</b> Tapón HS inferior adhesivo
Euro Runner 250tt  Ref: <b>40TP04</b> Tapeta guia posterior cruce	Euro Runner 250tt  Ref: <b>40TP05</b> Tapeta guia anterior	Euro Runner 250tt  Ref: <b>40TP06</b> Tope	Euro Runner 250tt  Ref: <b>40TP07</b> Tapa cruce inferior	Euro Runner 250tt  Ref: <b>40TP08</b> Goma tapeta inferior
Euro Runner 250tt  Ref: <b>40TP09</b> Terminal corredera	Euro Runner 250tt  Ref: <b>40TP10</b> Terminal corredera	Euro Runner 250tt  Ref: <b>40SQ01</b> Escuadra refuerzo	Wood  Ref: <b>40SR50</b> Bloqueo cerradura	Euro Runner 250 tt  Ref: <b>38754</b> Prolongador 1000 mm













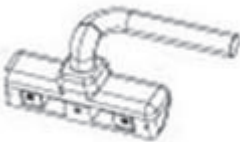

# Accesorios Euro Runner 250tt

				
<p>Euro Runner 250tt</p> <p>Ref. <b>M10059</b> Conjunto carros elevable de 250 Kgs</p>	<p>Euro Runner 250tt</p> <p>Ref. <b>M11325</b> Punto de pernio cierre lateral en plata</p>	<p>Euro Runner 250tt</p> <p>Ref. <b>M13341</b> Manillón + uñero exterior Plata</p>	<p>Euro Runner 250tt</p> <p>Ref. <b>M13343</b> Manillón interior / exterior Plata</p>	<p>Euro Runner 250tt</p> <p>Ref. <b>M22402</b> Cerradura de 1775 a 2060 mm</p>
				
<p>Euro Runner 250tt</p> <p>Ref. <b>M22403</b> Cerradura de 1925 a 2560 mm.</p>	<p>Euro Runner 250tt</p> <p>Ref. <b>M37647</b> Varilla unión carros de 1100 mm</p>	<p>Euro Runner 250tt</p> <p>Ref. <b>M37648</b> Varilla unión carros de 1600 mm.</p>	<p>Euro Runner 250tt</p> <p>Ref. <b>M37649</b> Varilla unión carros de 2100 mm.</p>	<p>Wood</p> <p>Ref. <b>M42011</b> Cerradura elevable</p>
				
<p>Euro Runner 250 tt</p> <p>Ref. <b>M42144</b> Guía varilla</p>	<p>Euro Runner 250 tt</p> <p>Ref. <b>M42278</b> Tope fin carrera</p>	<p>Euro Runner 250 tt</p> <p>Ref. <b>M42497</b> Terminal corredera</p>	<p>Euro Runner 250 tt</p> <p>Ref. <b>N21222</b> Cubre fresado</p>	

# Accesorios Premarco

				
<p>premarco</p> <p>Ref. <b>4500052</b> Cruceta 0,60 mm.</p>	<p>premarco</p> <p>Ref. <b>4500054</b> Garras</p>	<p>premarco</p> <p>Ref. <b>4500055</b> Cajetin cinta persiana</p>	<p>premarco</p> <p>Ref. <b>4500057</b> Cruceta 1 mt.</p>	<p>premarco</p> <p>Ref. <b>4500058</b> Placa pasacintas</p>
				
<p>premarco</p> <p>Ref. <b>4500059</b> Juego soporte reforzado.</p>	<p>premarco</p> <p>Ref. <b>4500060</b> Juego soporte simple</p>	<p>premarco</p> <p>Ref. <b>4500064</b> Cruceta 0,30 mm.</p>	<p>premarco</p> <p>Ref. <b>4500065</b> Escuadra premarco travesaño</p>	

				
Ref. <b>1AS80</b> Clavija para escuadra <b>*Consultar stock</b>	Ref. <b>5CG06</b> Junta de vidrio 6 mm <b>*Consultar stock</b>	Ref. <b>5CG71</b> Junta de solape hoja <b>*Consultar stock</b>	Ref. <b>5CG72</b> Junta de solape hoja <b>*Consultar stock</b>	Ref. <b>5CG73</b> Goma estanqueidad <b>*Consultar stock</b>
				
Ref. <b>5CG74</b> Goma abertura hoja <b>*Consultar stock</b>	Ref. <b>5CG80</b> Junta unión dilatación <b>*Consultar stock</b>	Ref. <b>5CG81</b> Junta marco <b>*Consultar stock</b>	Ref. <b>5CG82</b> Junta de dilatación <b>*Consultar stock</b>	Ref. <b>5FAC1</b> Conjunto anclaje central <b>*Consultar stock</b>
				
Ref. <b>5FAL1</b> Conjunto anclaje lateral <b>*Consultar stock</b>	Ref. <b>5FAV6 - 5AFV6</b> Tornillo para fijación de montante <b>*Consultar stock</b>	Ref. <b>5FB02</b> Apoyo hoja estanqueidad fija <b>*Consultar stock</b>	Ref. <b>5FC01</b> Compás abertura <b>*Consultar stock</b>	Ref. <b>5FK01</b> Kit de fijación de hoja fija <b>*Consultar stock</b>
				
Ref. <b>5FG00</b> Junta de presión <b>*Consultar stock</b>	Ref. <b>5FG01</b> Goma de estanqueidad <b>*Consultar stock</b>	Ref. <b>5FG02</b> Goma de 2 mm <b>*Consultar stock</b>	Ref. <b>5FM05</b> Maneta proyectable <b>*Consultar stock</b>	Ref. <b>5FM20</b> Encuentro manilla <b>*Consultar stock</b>

				
Ref: <b>5FP01</b> Pletina fijación travesaño *Consultar stock	Ref: <b>5FS61</b> Escuadra a remachar *Consultar stock	Ref: <b>5FS71</b> Escuadra remache *Consultar stock	Ref: <b>5FT01</b> Junta de dilatación travesaño *Consultar stock	Ref: <b>5FT28</b> Tapón para perfil 21128 *Consultar stock
				
Ref: <b>5FT60</b> Tapeta para perfil 24601 *Consultar stock	Ref: <b>50MA01</b> Cremona Dx *Consultar stock	Ref: <b>50PA02</b> Tope cierre *Consultar stock	Ref: <b>8033</b> Junta solape interior/exterior	Ref: <b>8035</b> Junta cuña 2 mm
				
Ref: <b>8039</b> Junta para pivotante	Ref: <b>8040</b> Junta de fijación *Consultar stock	Ref: <b>8044</b> Junta de dilatación interior *Consultar stock	Ref: <b>8201</b> Goma para hoja semiestanca *Consultar stock	Ref: <b>8202</b> Junta hoja estanca *Consultar stock

