

SISTEMI PER SERRAMENTI

**UNIFORM**

*Sistema 5000/S – BRONZO*

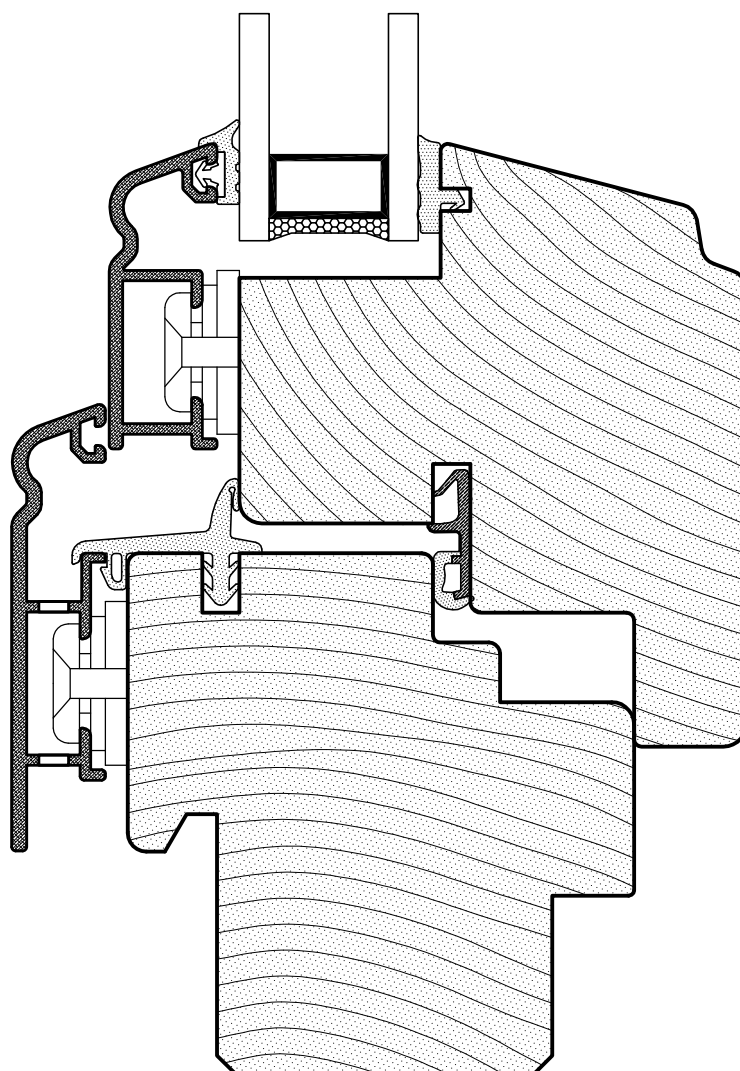

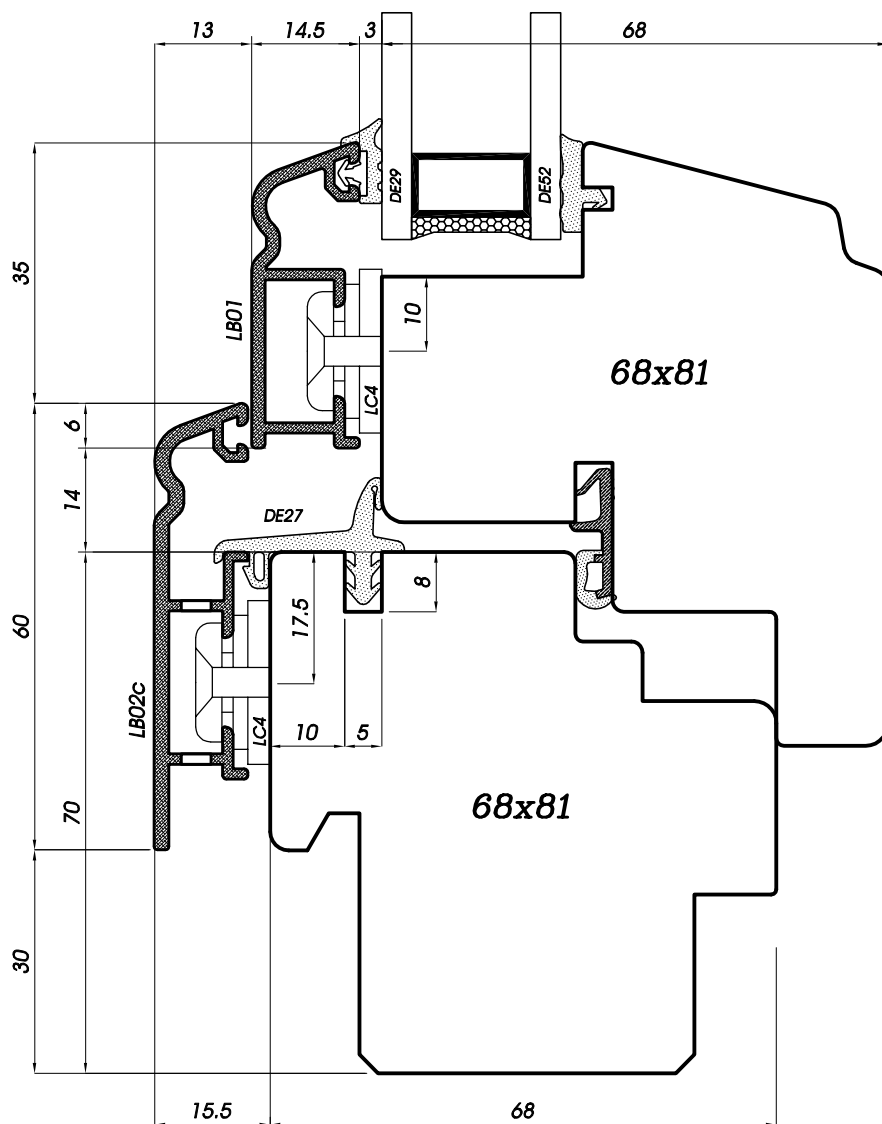

Sezione verticale traverso inferiore finestra  
 Vertikalschnitt Fenster unten quer  
 Sección vertical travesaño inferior de la ventana  
 Coupe verticale traverse inférieure fenêtr  
 Vertical section of the window's lower ledger

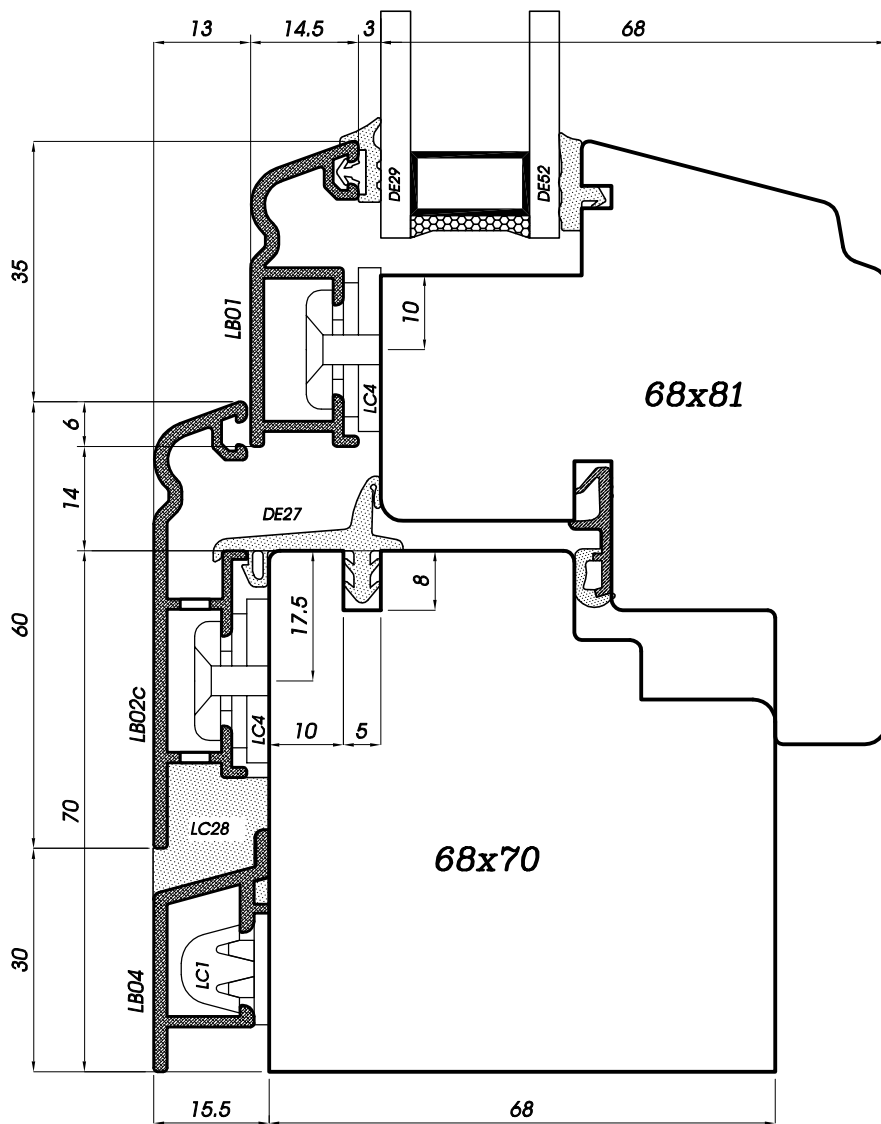

Sezione verticale traverso inferiore finestra  
 Vertikalschnitt Fenster unten quer  
 Sección vertical travesaño inferior de la ventana  
 Coupe verticale traverse inférieure fenêtr  
 Vertical section of the window's lower ledger

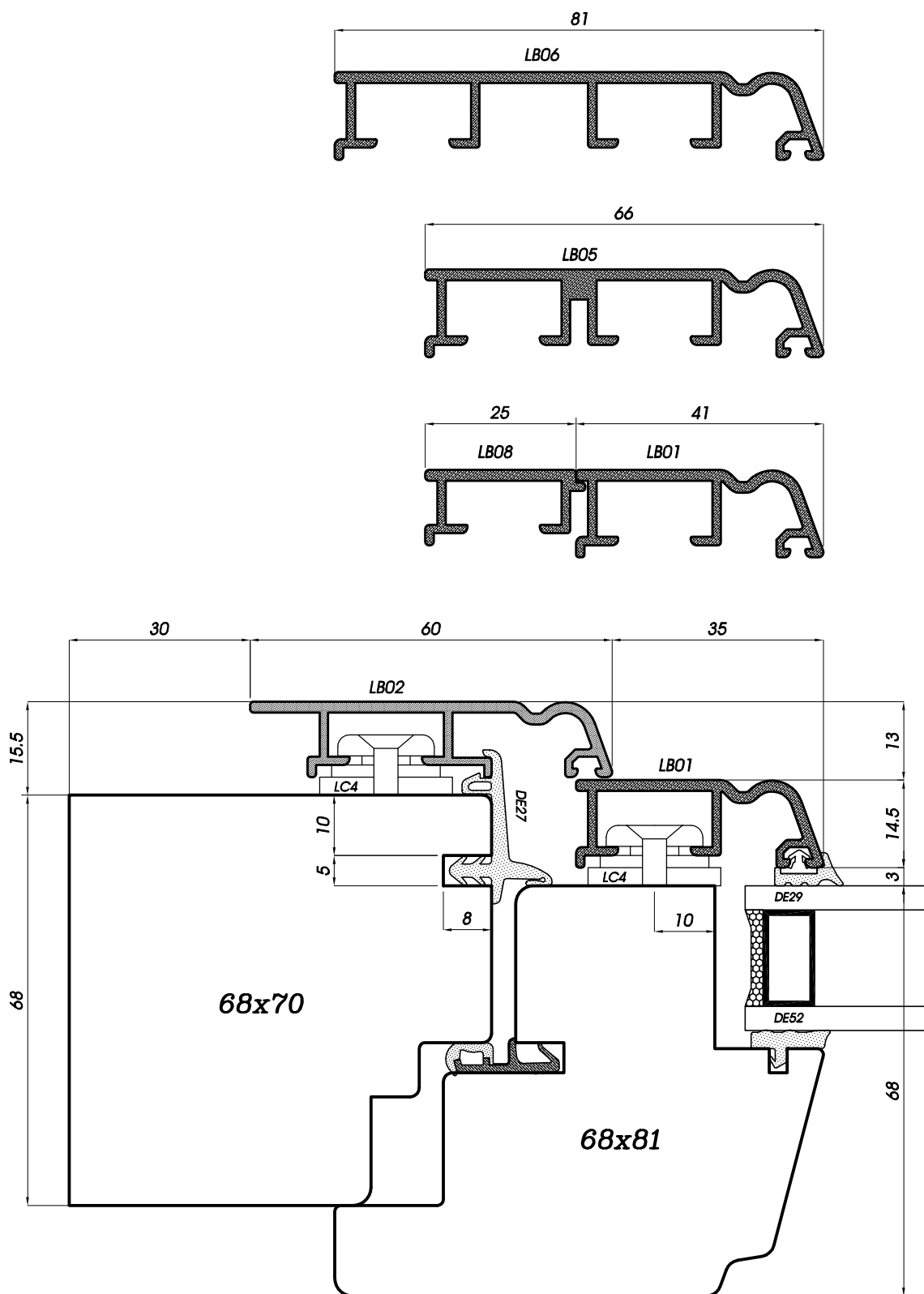

Sezione orizzontale montanti laterali  
 Horizontalschnitt senkrecht seitlich  
 Sección horizontal de montantes laterales  
 Coupe horizontale montants latéraux  
 Horizontal section of the lateral jamb

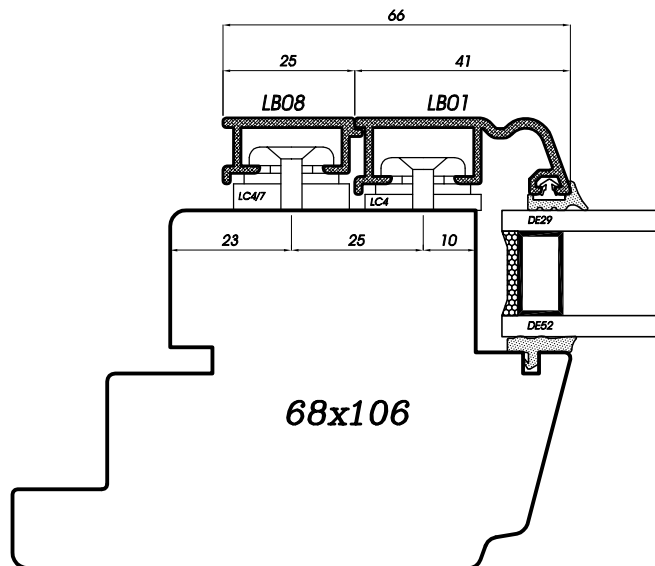
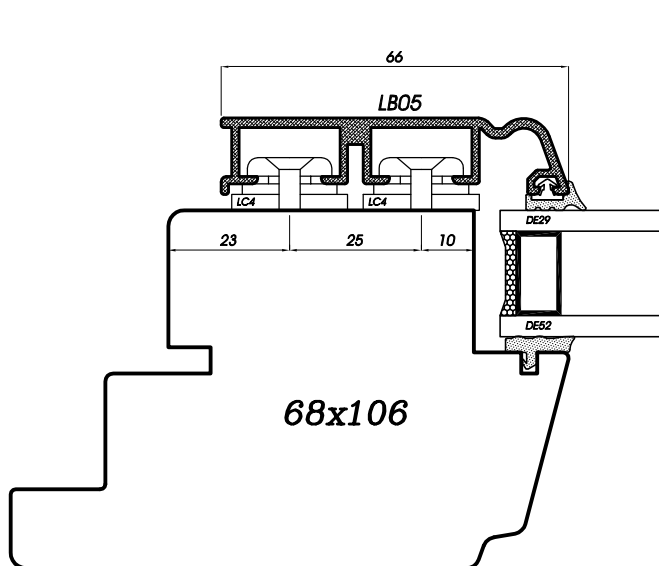
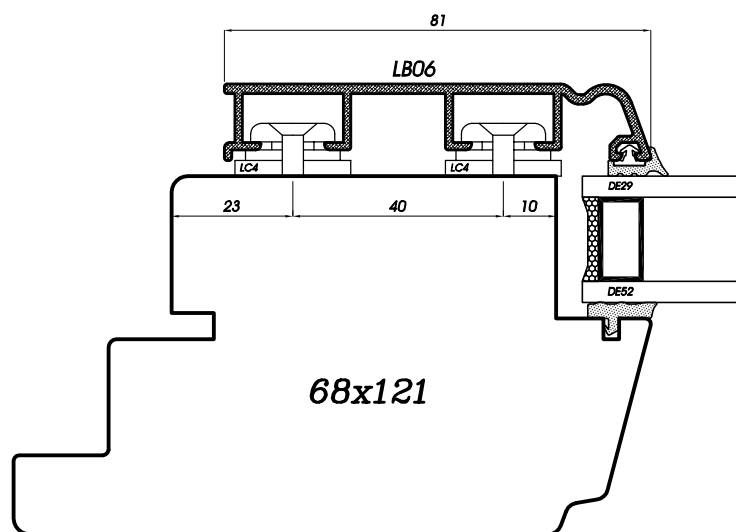
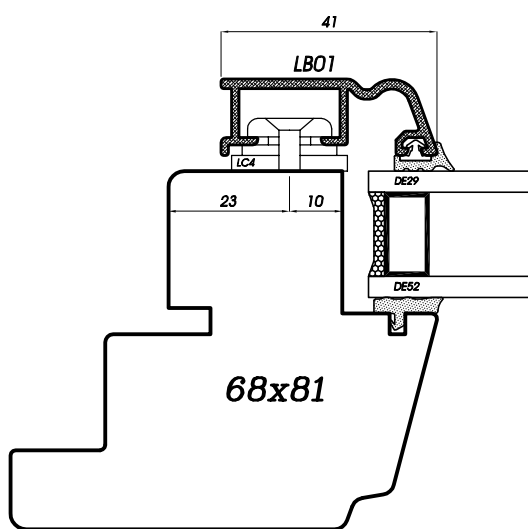

Sezioni orizzontali battenti  
 Horizontalschnitt Flügel  
 Secciones horizontales hojas  
 Coupes horizontales vantaux  
 Horizontal section of the wings

Terminali LC247

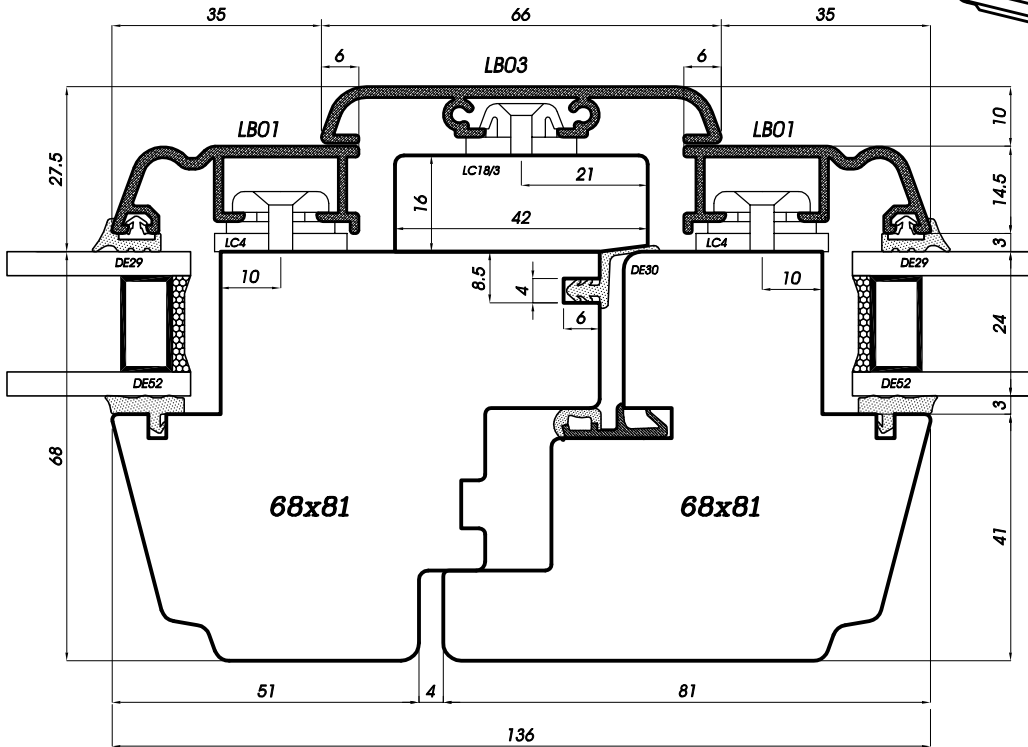

Terminali LC35

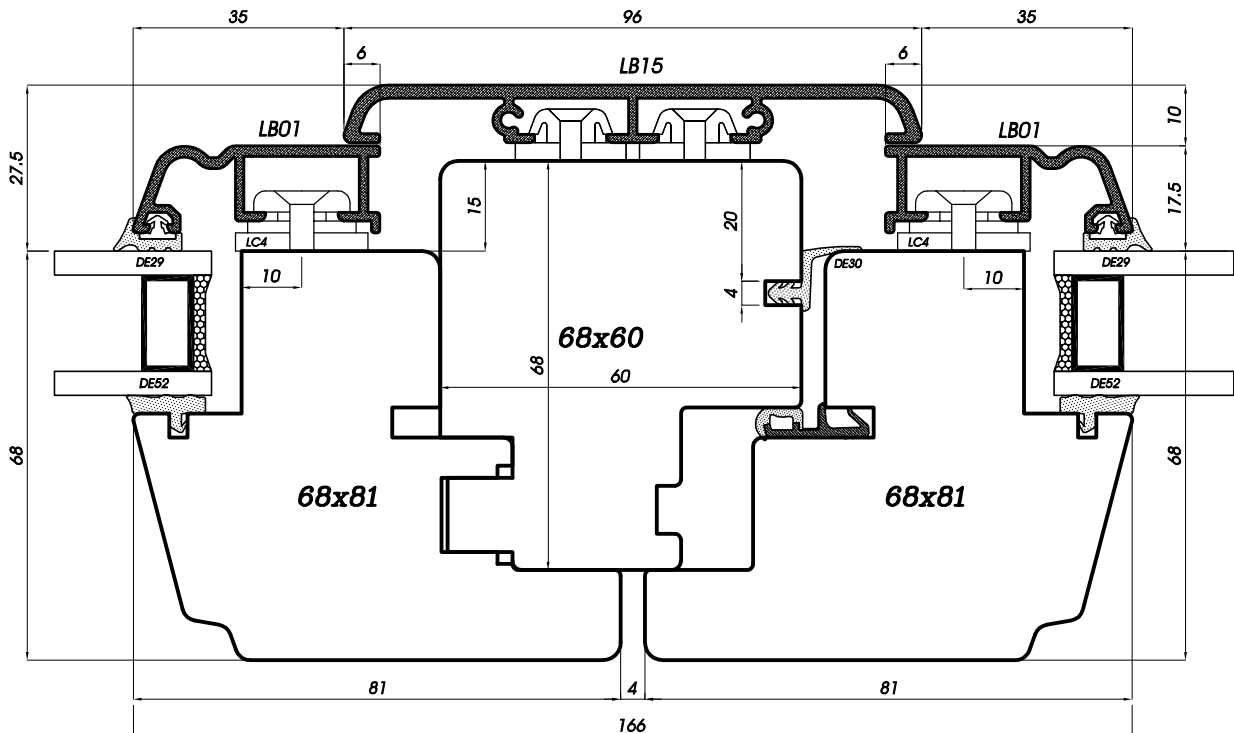

Sezione orizzontale chiusura centrale con profili LB03-LB15  
 Horizontalschnitt Stulpprofil LB03-LB15  
 Sección horizontal del cierre central con perfiles LB03-LB15  
 Coupe horizontale battement central avec profil LB03 - LB15  
 Horizontal section of the middle clamp with profiles LB03-LB15

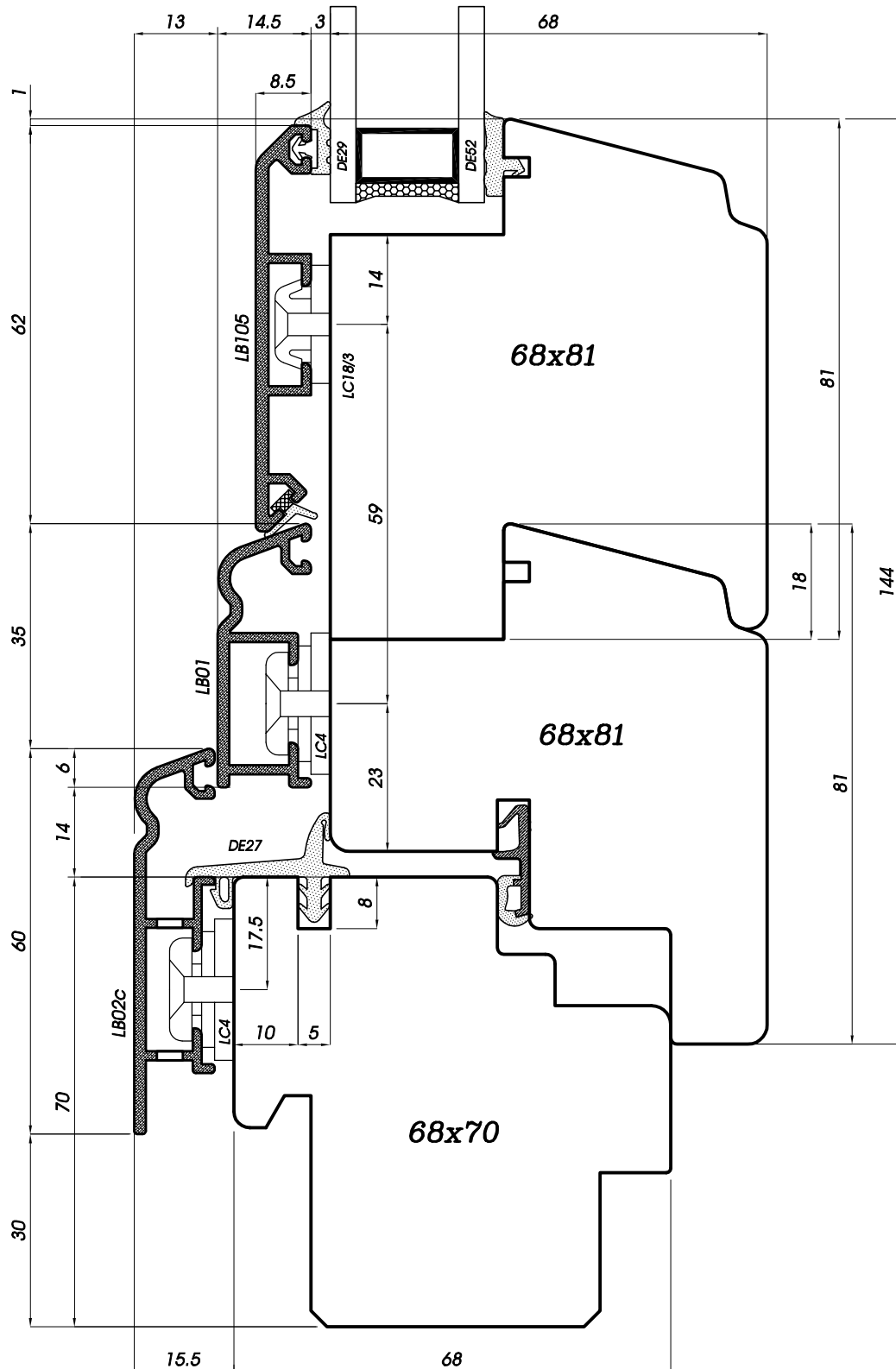

Sezione verticale traverso inferiore portafinestra  
 Vertikalschnitt Balkontür quer unten  
 Sección vertical travesaño inferior puertaventana  
 Coupe verticale traverse inférieure porte-fenêtre  
 Vertical section of the window-door's lower ledger

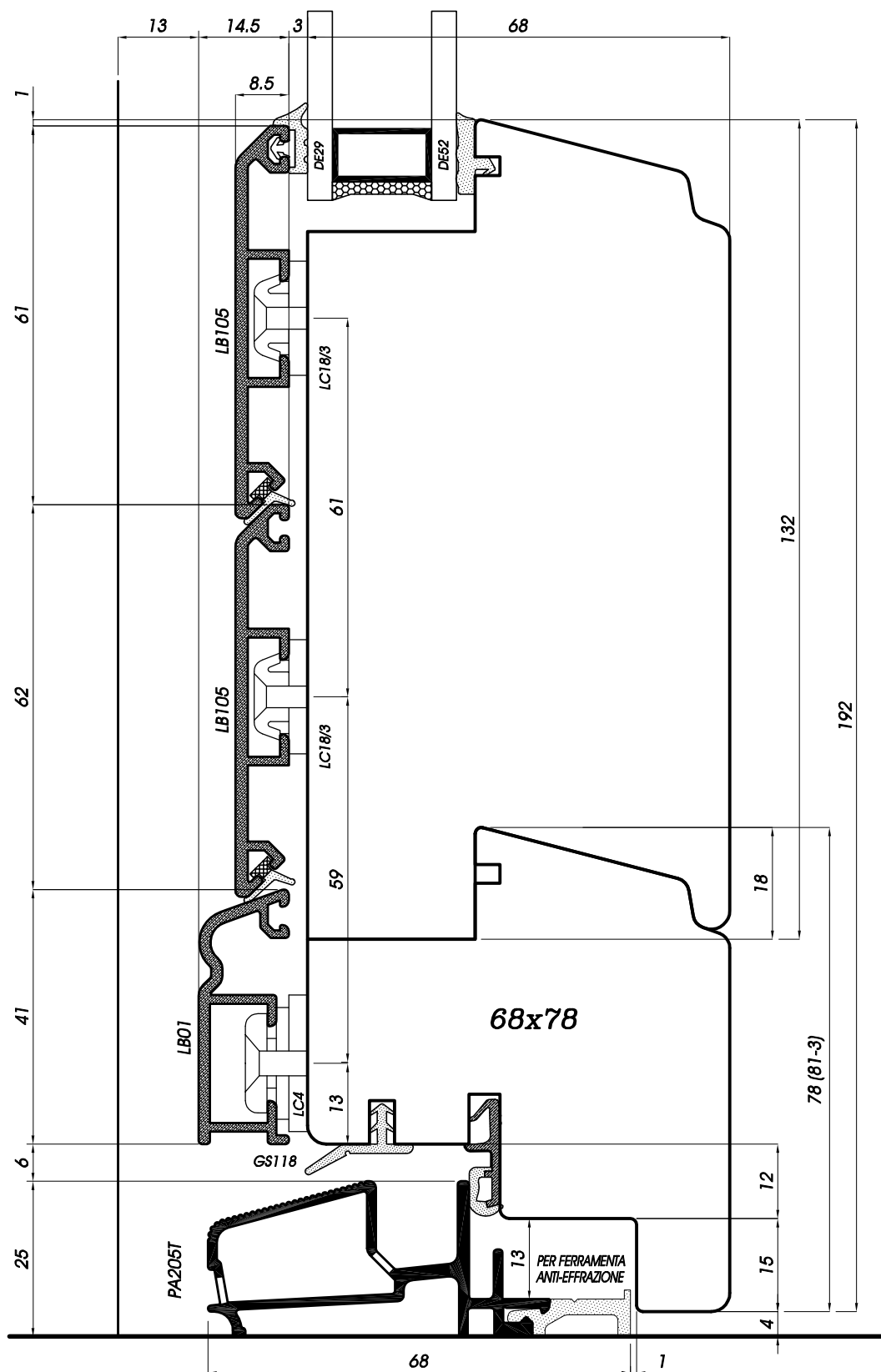

Sezione verticale traverso inferiore portafinestra con soglia a pavimento PA205T  
 Vertikalschnitt Balkontür quer unten mit Schwelle PA205T  
 Sección vertical travesaño inferior puertaventana con umbral PA205T  
 Coupe verticale traverse inférieure porte-fenêtre avec seuil PA205T  
 Vertical section of the window-door's lower ledger with aluminium sill PA205T



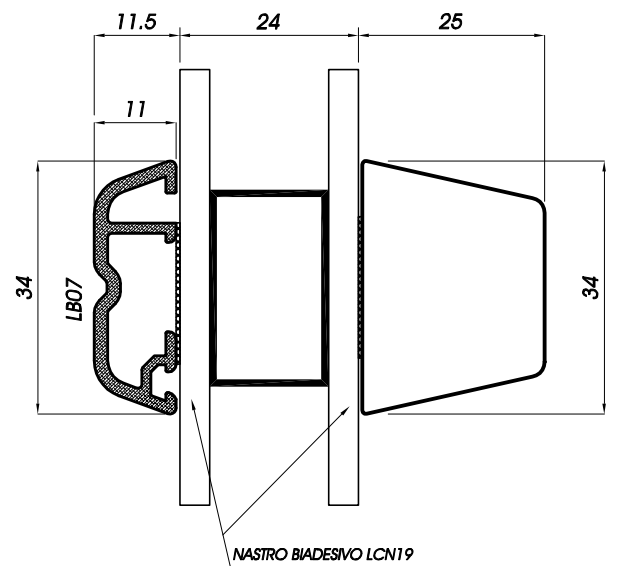
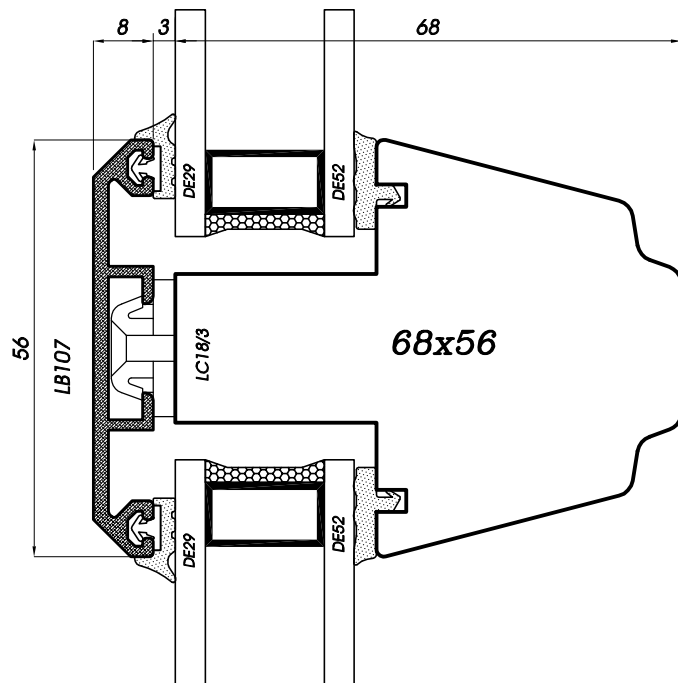
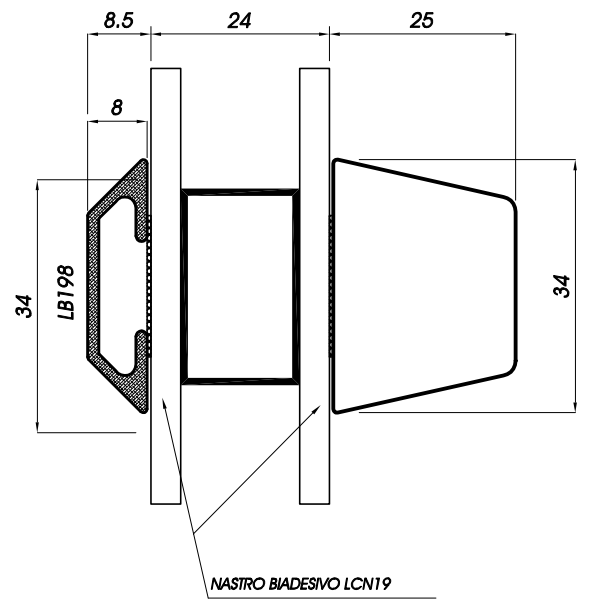
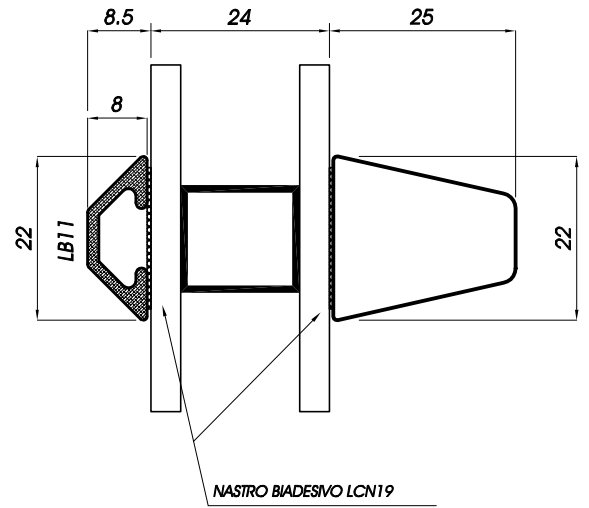
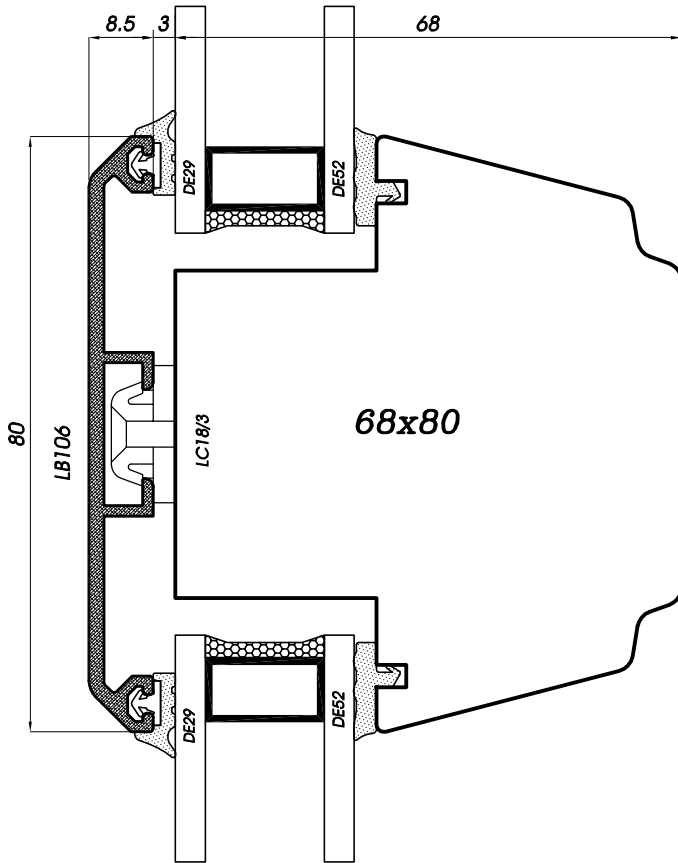

Sezione verticale traversi intermedi anta  
 Vertikalschnitt der Sprossen im Flügel  
 Sección vertical travesaños intermedios hojas  
 Coupe verticale des traverses intermédiaires du vantail  
 Vertical section of the wing's lower ledgers

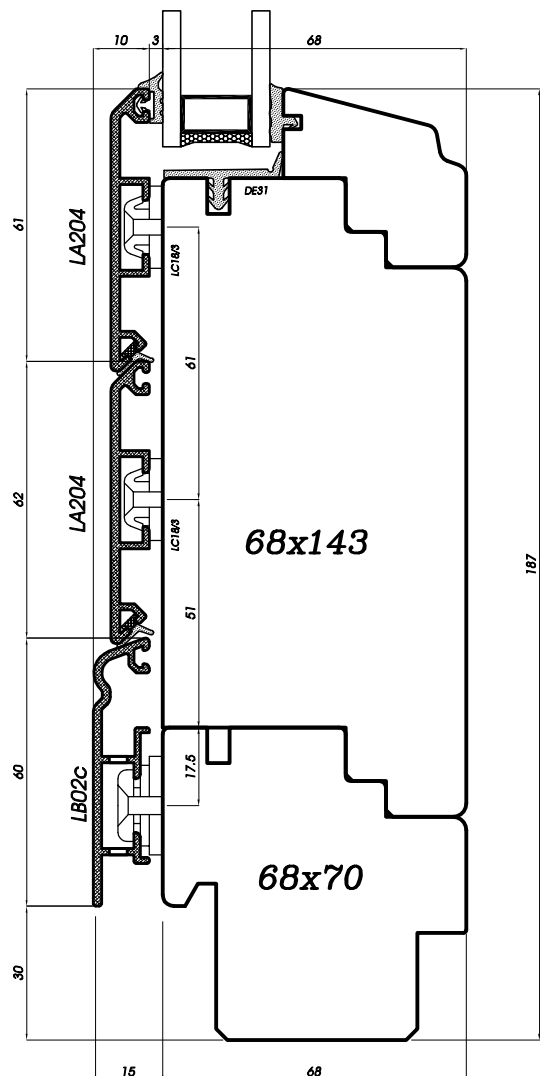
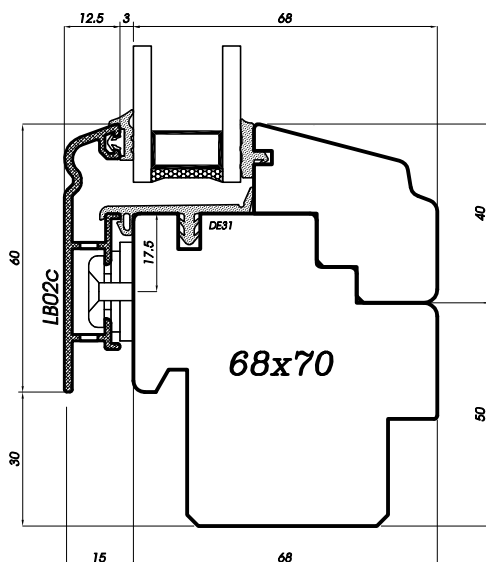
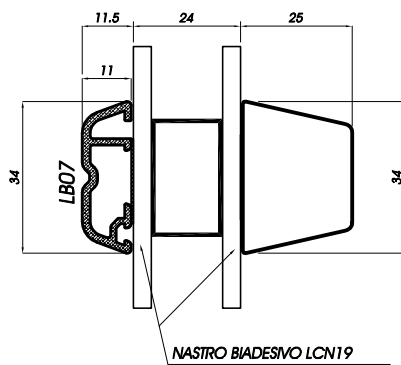
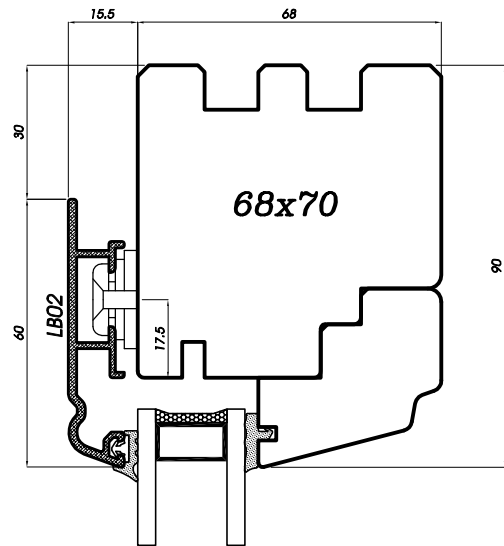
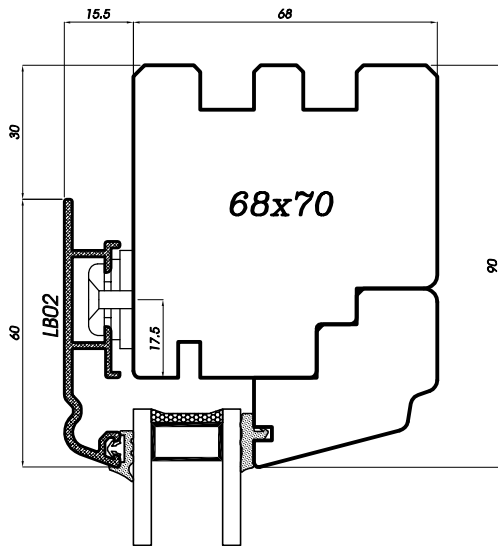

**Sezione verticale finestra e portafinestra con vetro fisso**  
**Vertikalschnitt Fenster und Balkontür mit Fixverglasung**  
**Sección vertical ventana y puertaventana con cristal fijo**  
**Coupe verticale fenêtre et porte-fenêtre avec vitre fixe**  
**Vertical section of the window and window-door with fixed glass**

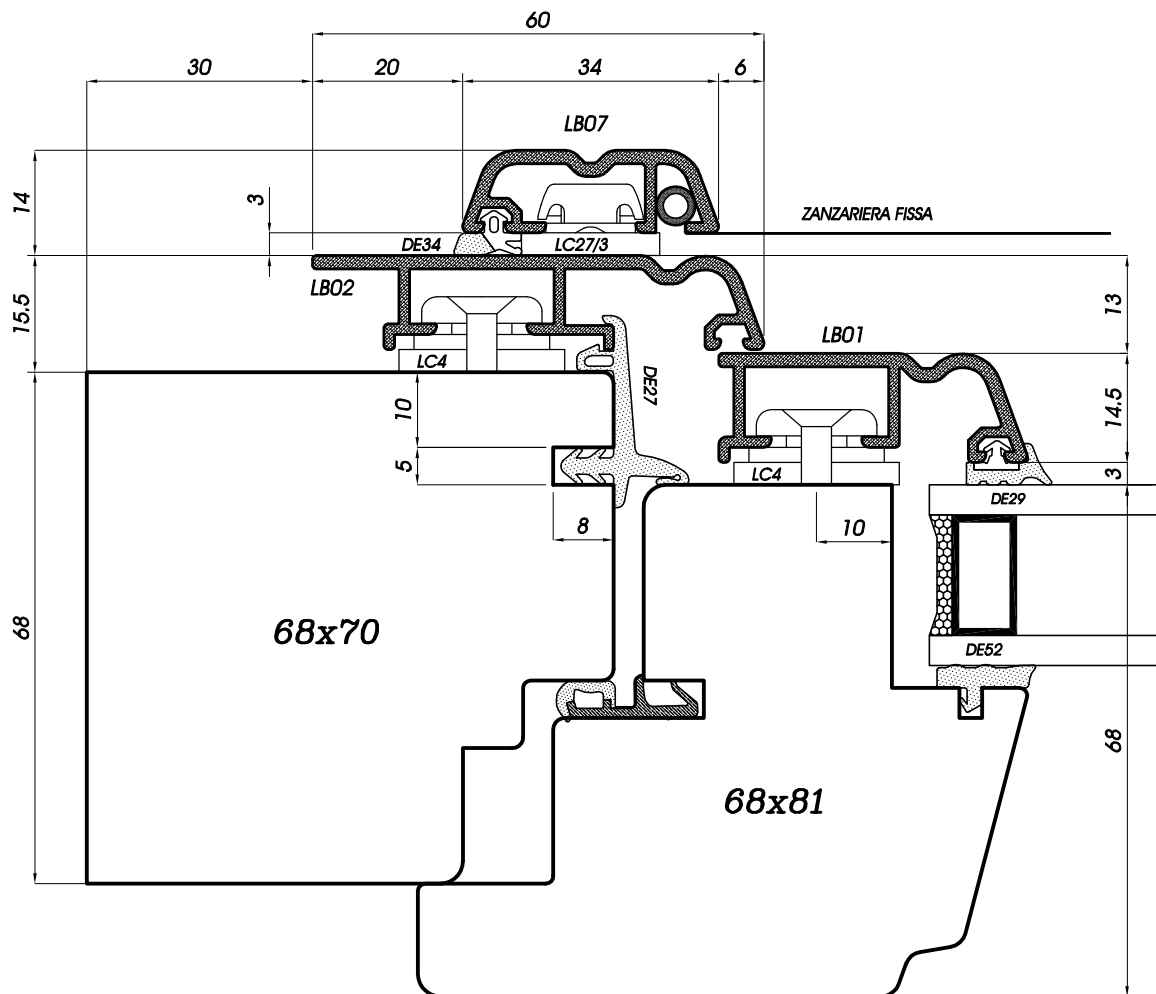

Sezione orizzontale con zanzariera  
 Horizontalschnitt Fenster mit vorge-setztem Fliegengitter  
 Sección horizontal ventana con mosquitera  
 Coupe horizontale avec moustiquaire  
 Horizontal section with mosquito-net

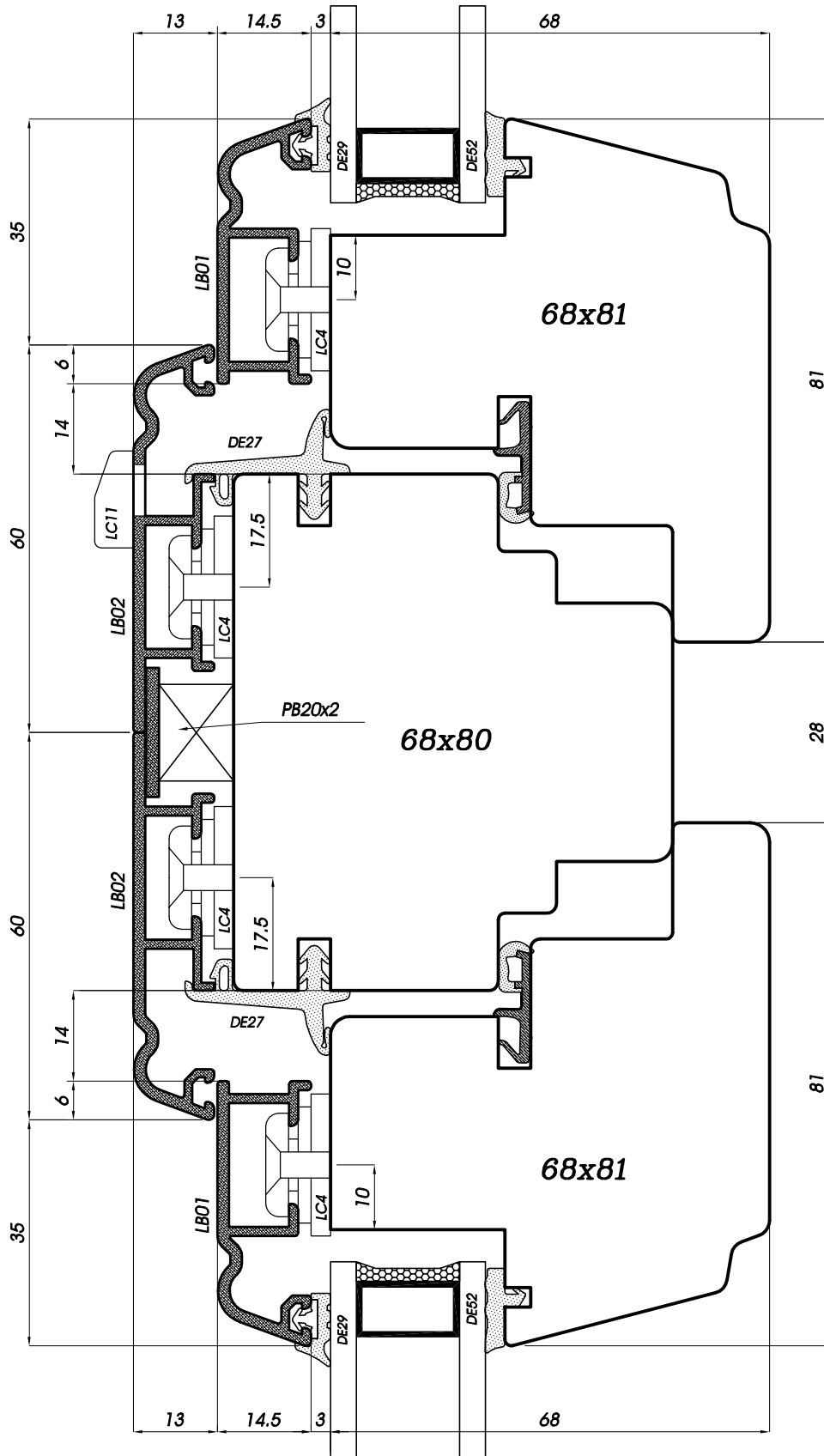

Sezione verticale traverso intermedio telaio  
 Vertikalschnitt Rahmensprossen  
 Sección vertical travesañio intermedio del marco  
 Coupe verticale de la traverse intermédiaire du dormant  
 Vertical section of the middle lower ledger

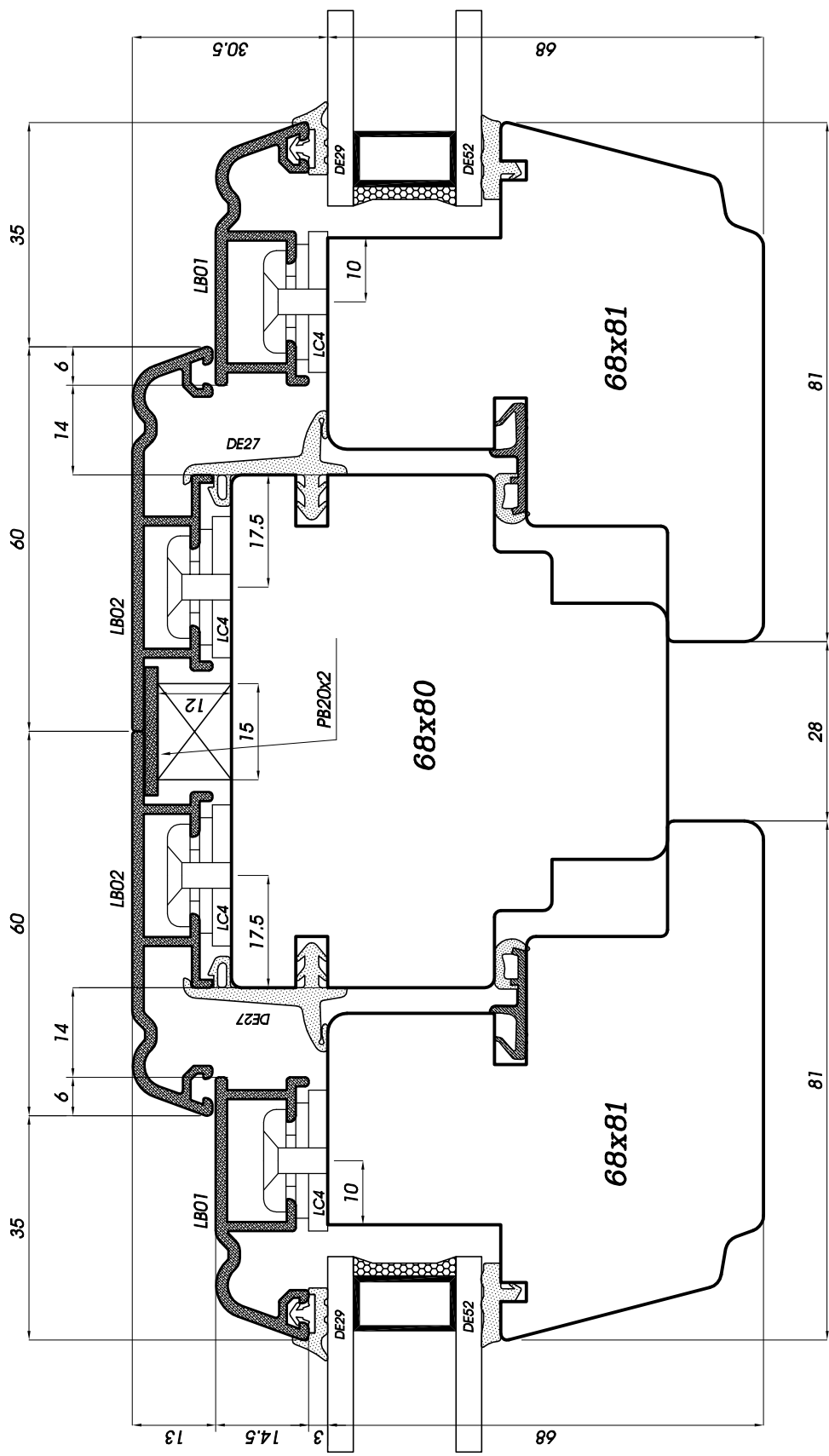

Sezione orizzontale montante intermedio telaio  
 Horizontalschnitt Setzholz Rahmen  
 Sección horizontal montante intermedio del marco  
 Coupe horizontale montant intermédiaire dormant  
 Horizontal section with the frame's middle jamb

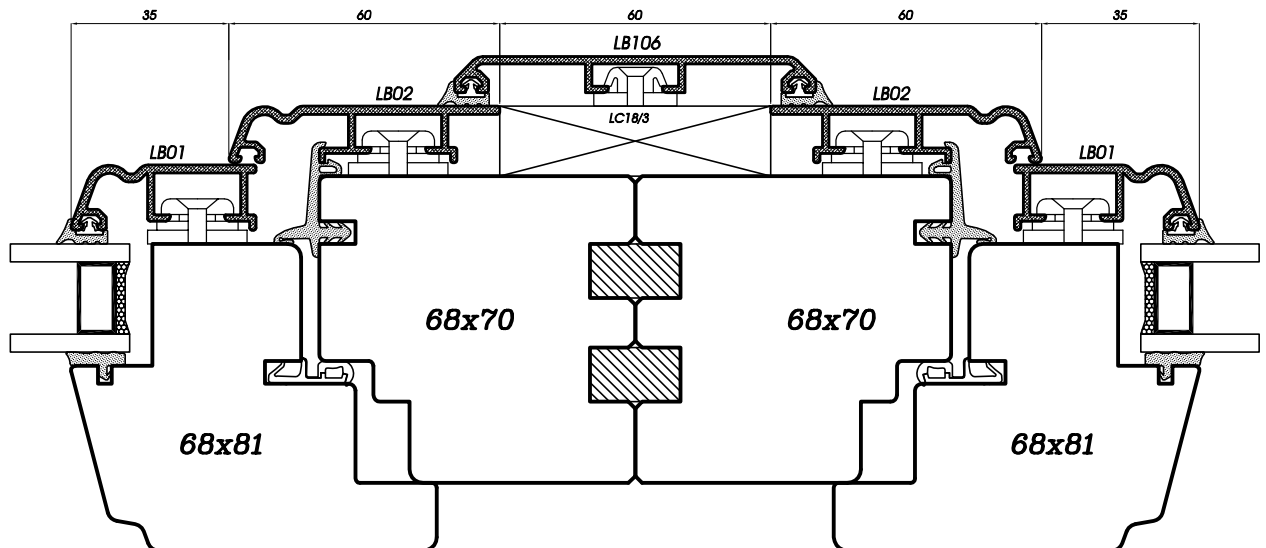
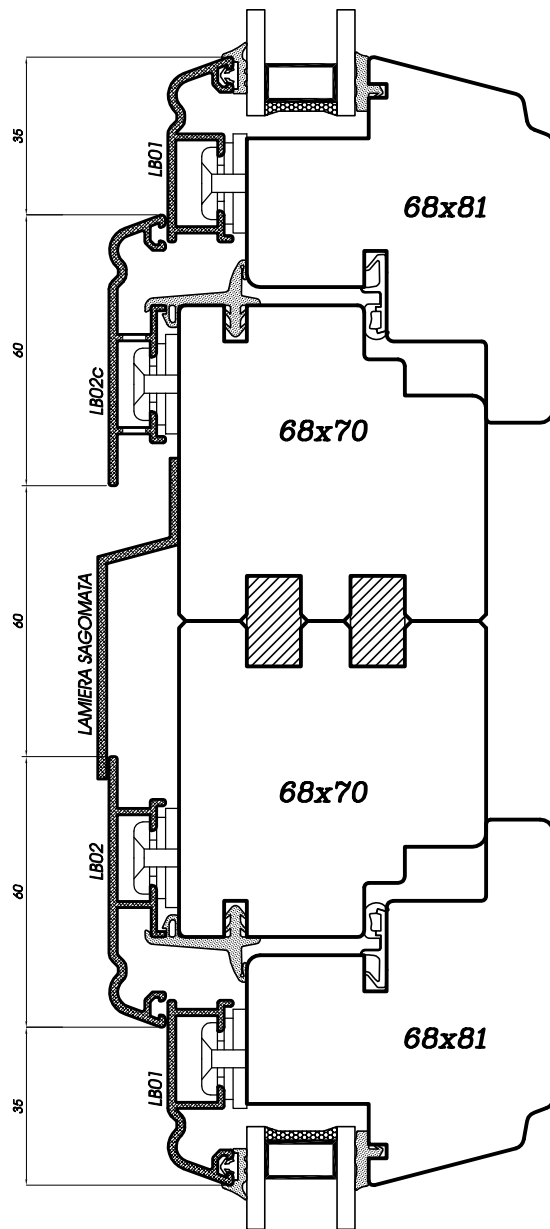
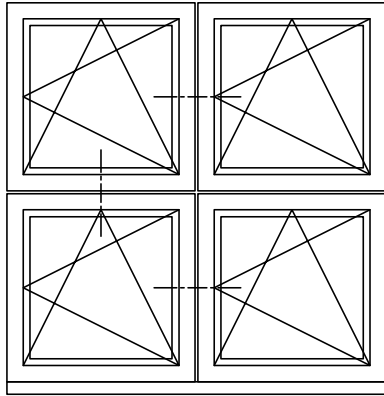

Sezione orizzontale e verticale finestre accoppiate con telaio larghezza 70 mm.  
 Horizontal- und Vertikalschnitt gekoppelte Fenster Holzbreite 70mm  
 Sección horizontal y vertical de ventanas acopladas con anchura del marco de madera de 70 mm  
 Coupe horizontale et verticale accouplement de dormants largeur 70 mm  
 Horizontal and vertical section of connected windows with frame's breadth of 70 mm

# GEOMETRIE REALIZZABILI

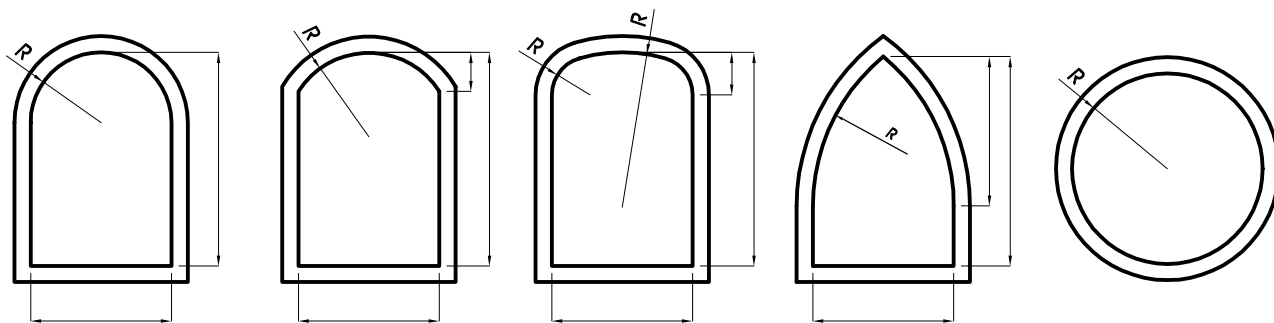

RAGGI MINIMI DI CURVATURA (esterno profilo)	
PROFILI BRONZO	RAGGIO (ext.)
LB01	300 mm
LB02	300 mm
LB05	500 mm
LB06	650 mm
LB13	1000 mm

*I PROFILI NON CONTRASSEGNA TI SONO DA FARE SU ORDINAZIONE*

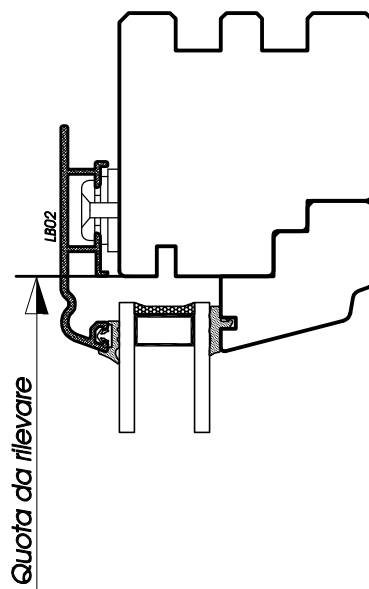
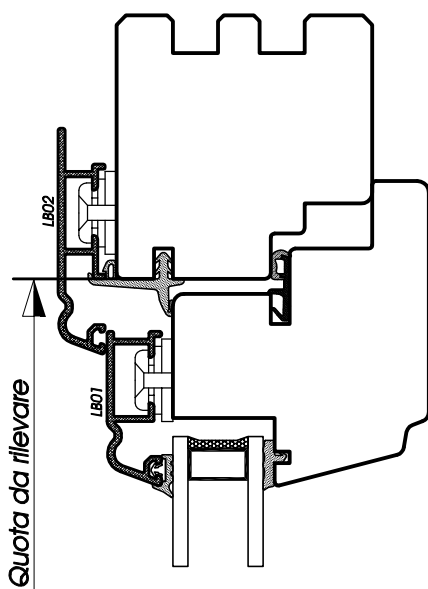

*Sezione verticale di riferimento per la rilevazione dei raggi di curvatura*  
*Vertikalschnitt zur Berechnung der Radien*  
*Sección vertical de referencia para medir los radios de curvatura del aluminio*  
*Coupe verticale de référence pour mesurer les rayons du cintrage*  
*Datum vertical section for the measurement of the sweep's radius*

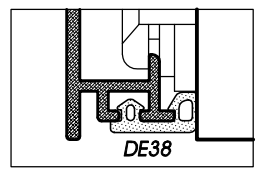
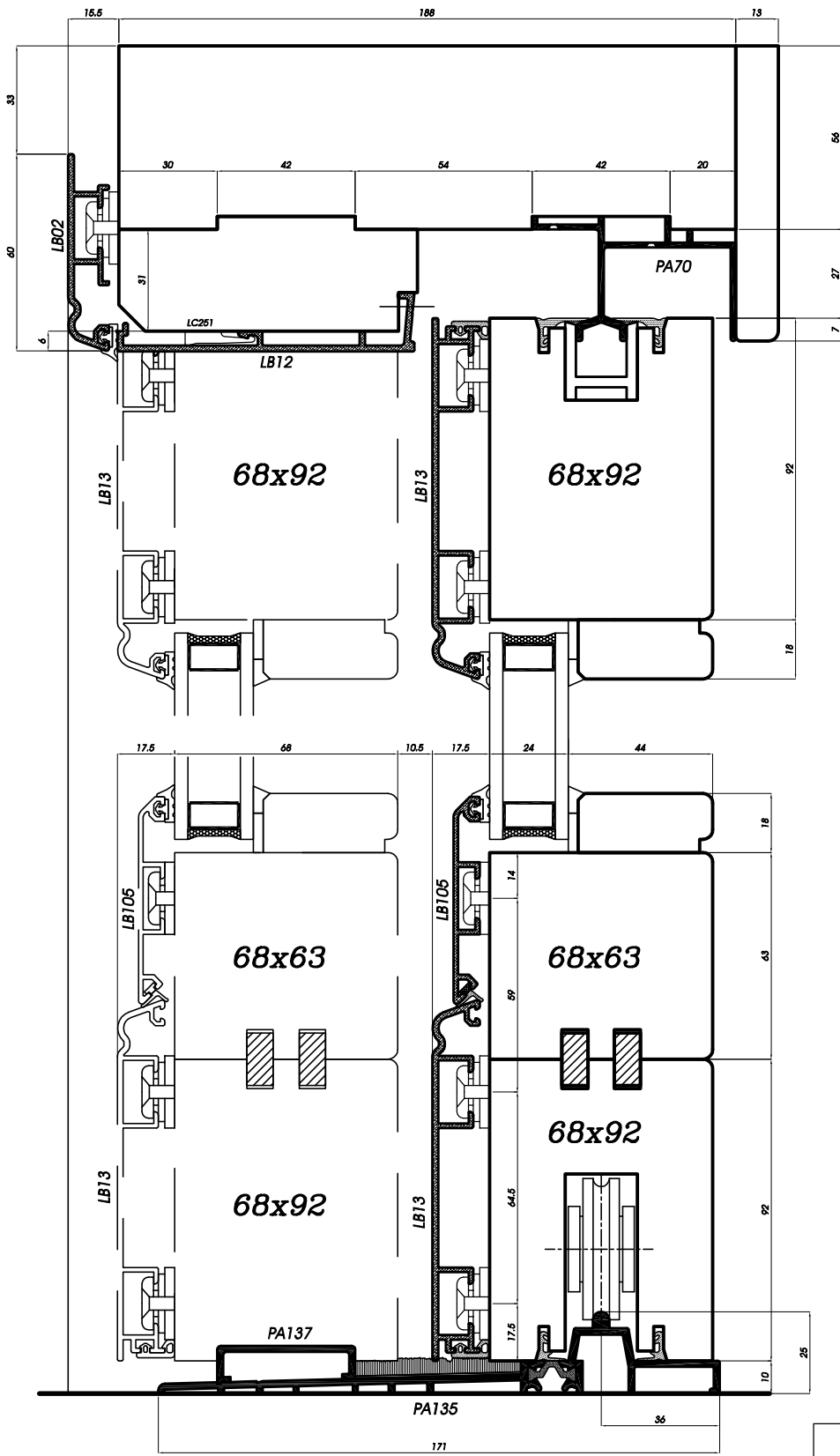

Sezione verticale serramento alzante scorrevole sp.68mm  
 Vertikalschnitt Hebe-Schiebe-Tür Holzstärke 68mm  
 Sección vertical corredera elevadora con madera espesor 68mm  
 Coupe verticale fenêtre levante-coulissante épaisseur 68mm  
 Vertical section of sliding window-door with a thickness of 68 mm



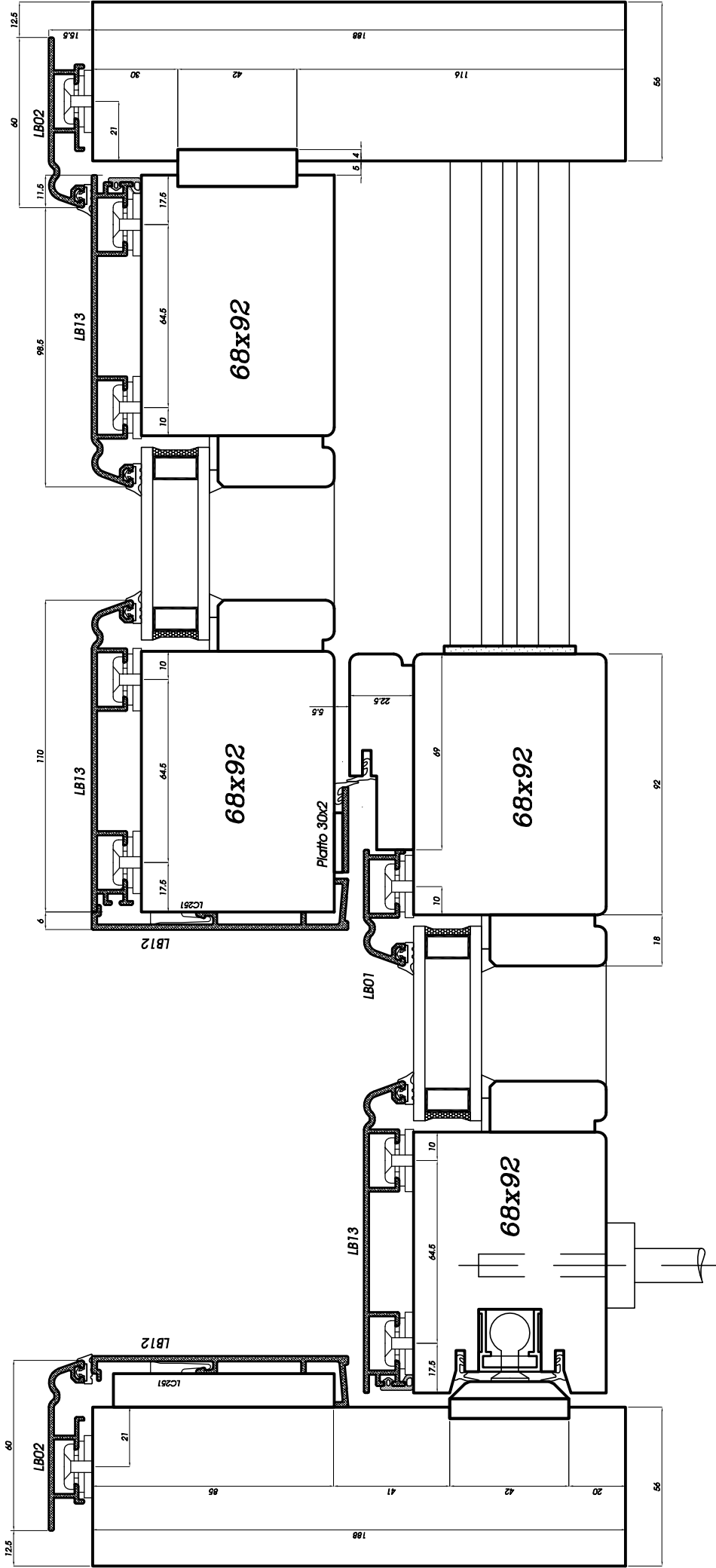

Sezione orizzontale serramento alzante scorrevole sp.68mm  
 Horizontalschnitt Hebe-Schiebe-Tür Holzstärke 68mm  
 Sección horizontal corredera elevadora con madera esesor 68mm  
 Coupe horizontale fenêtre levante-couissante épaisseur 68mm  
 Horizontal section of sliding window-door with a thickness of 68 mm

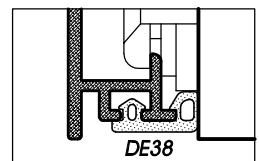
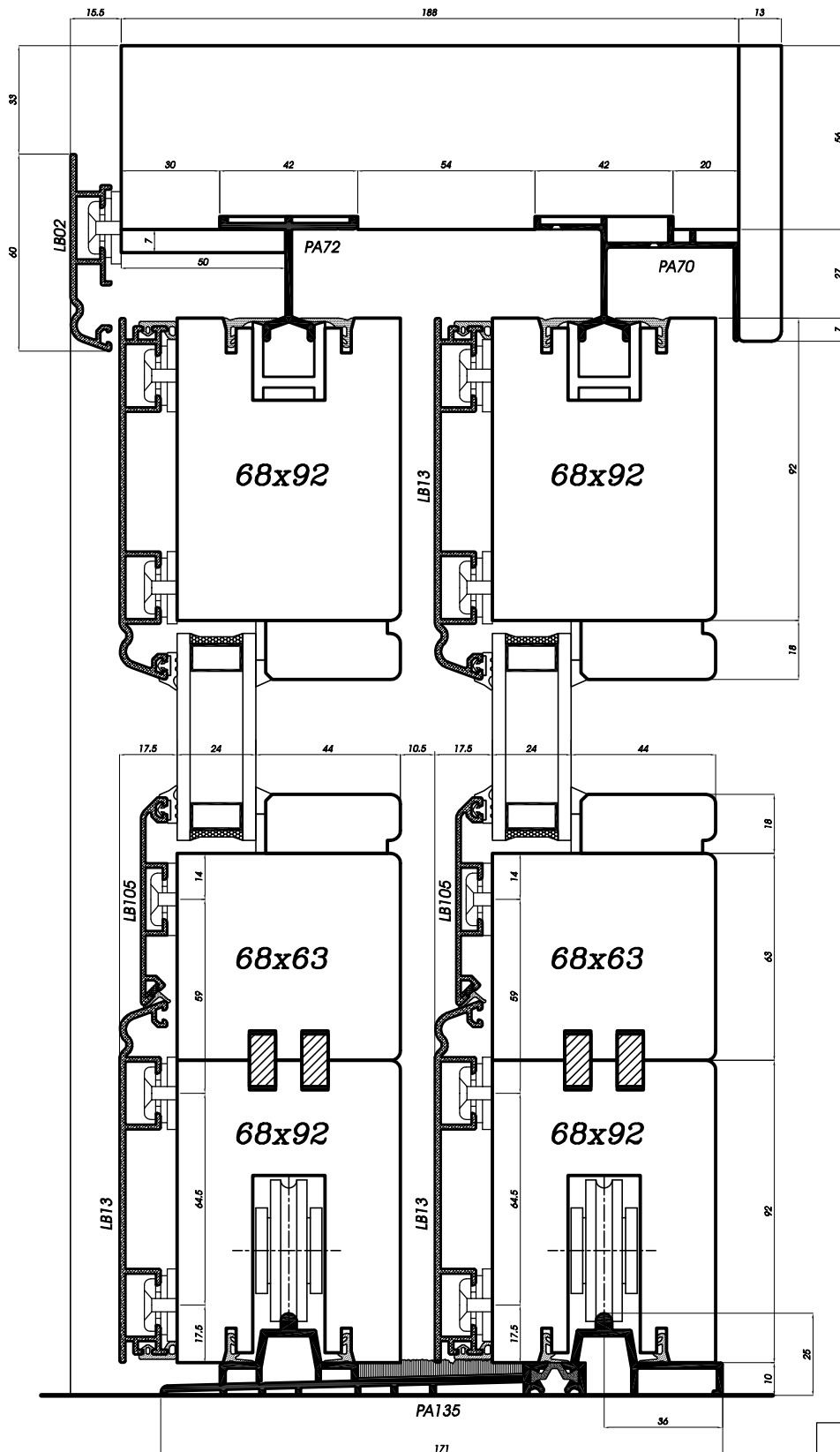

Sezione verticale serramento alzante scorrevole sp.68mm con doppia anta mobile  
 Vertikalschnitt Hebe-Schiebe-Tür, zwei-flügelig, Holzstärke 68mm  
 Sección vertical corredera elevadora con madera espesor 68mm con doble hoja practicable  
 Coupe verticale fenêtre levant-coulissante épaisseur 68 mm - 2 vantaux mobiles  
 Vertical section of the sliding window-door with a thickness of 68 mm and double movable wing

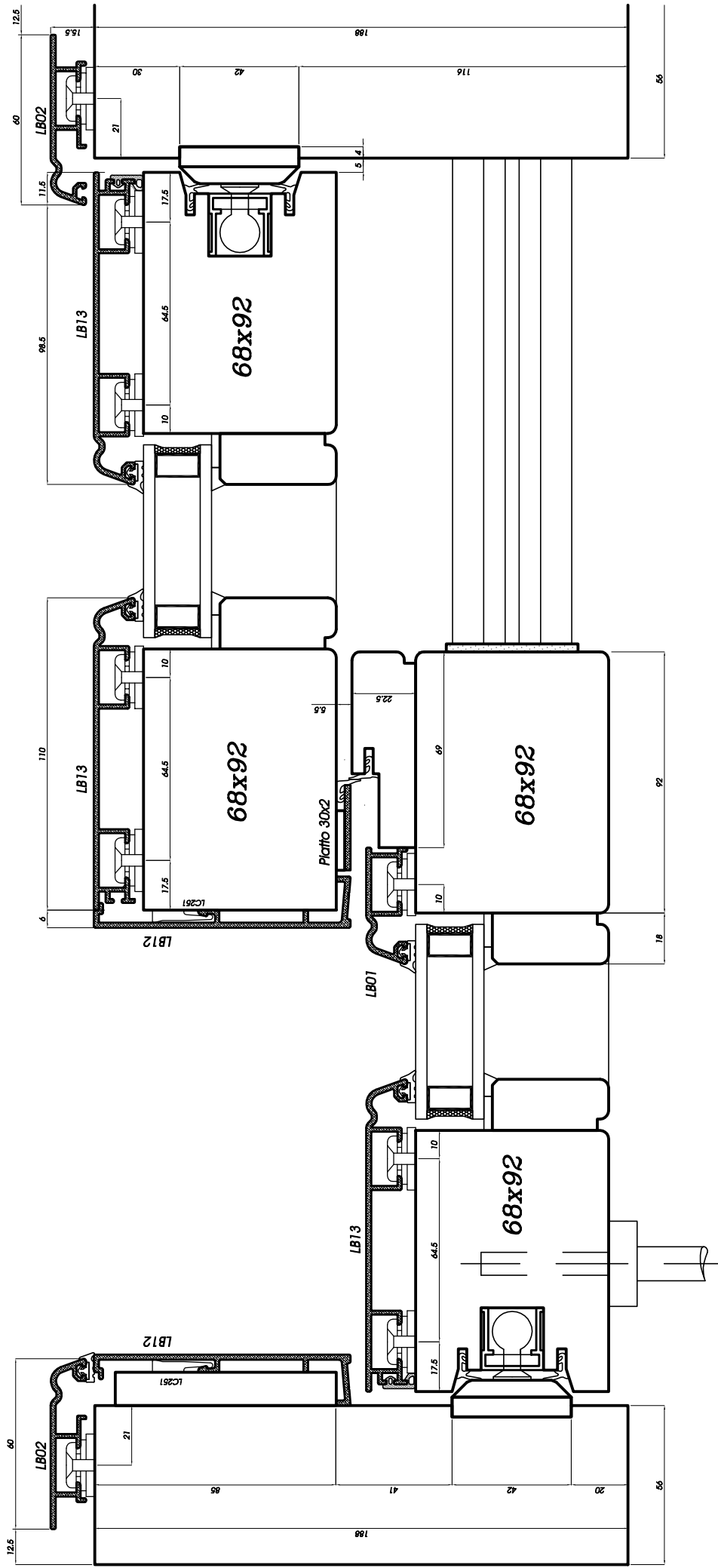

Sezione orizzontale serramento alzante scorrevole sp.68mm con doppia anta mobile

Horizontalschnitt Hebe-Schiebe-Tür, 2-flg., Holzstärke 68mm

Sección horizontal corredera elevadora con madera espesor 68mm con doble hoja practicable

Coupe horizontale fenêtre levant-coulissante épaisseur 68 mm - 2 vantaux mobiles

Horizontal section of the sliding window-door with a thickness of 68 mm and double movable wing

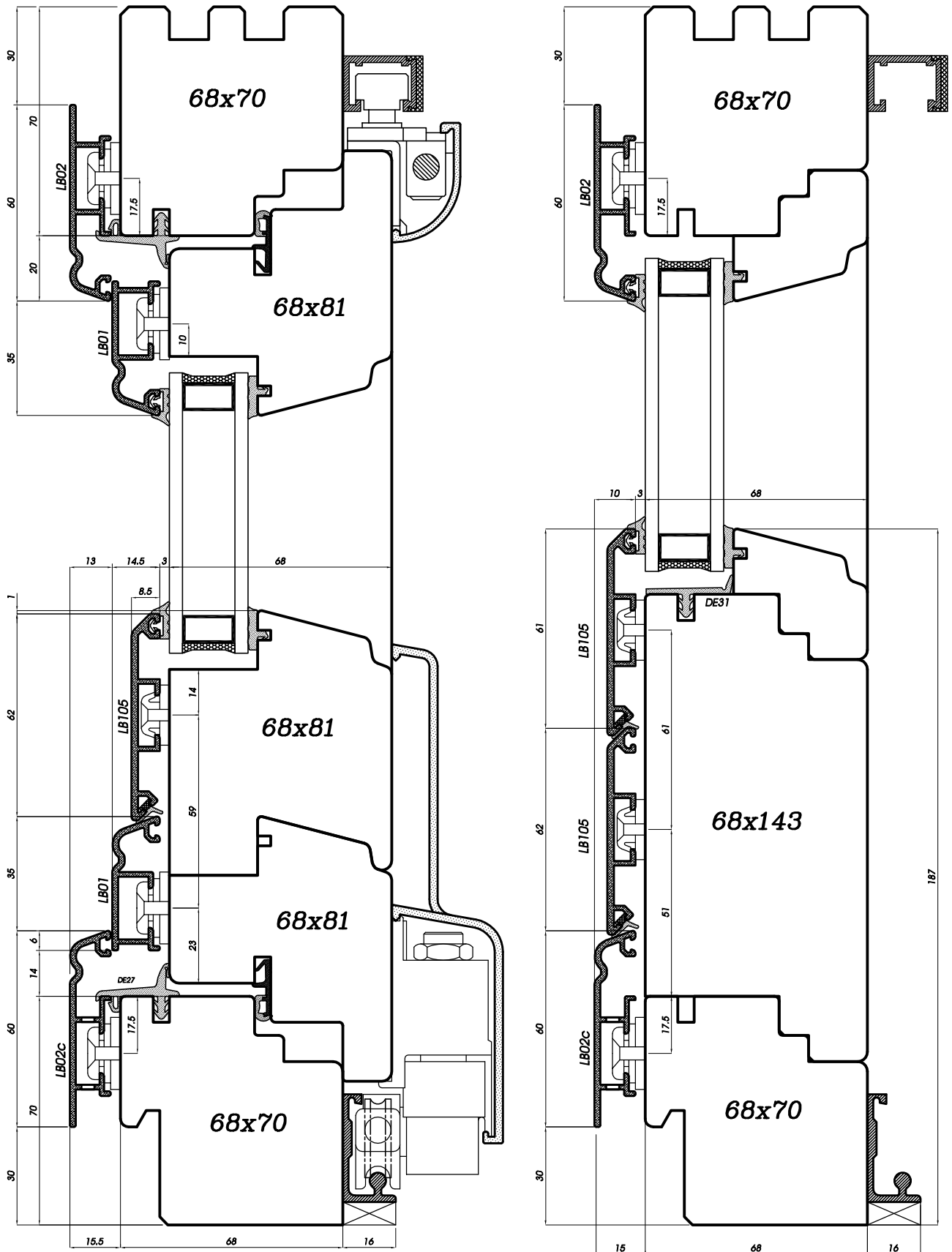

Sezione verticale portafinestra con scorrevole parallelo  
 Vertikalschnitt Parallelschiebekipptür  
 Sección vertical puertaventana con corredera paralela  
 Coupe verticale porte-fenêtre coulissante à translation  
 Vertical section of the window-door with parallel sliding door

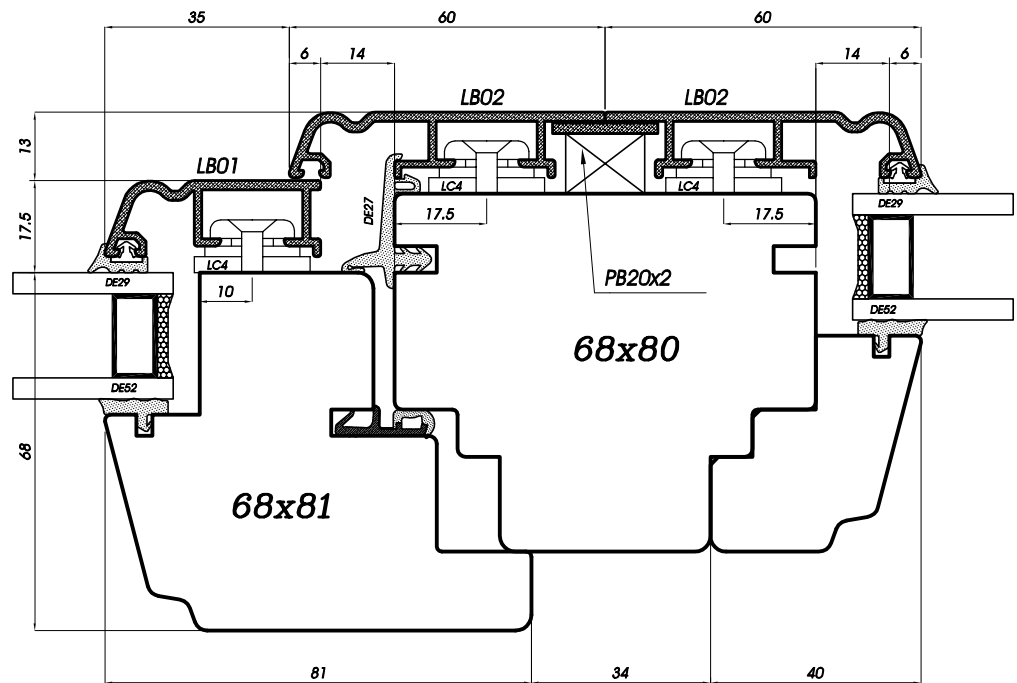
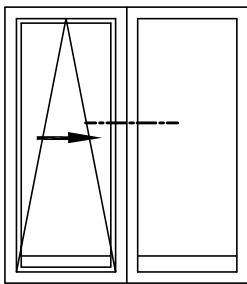
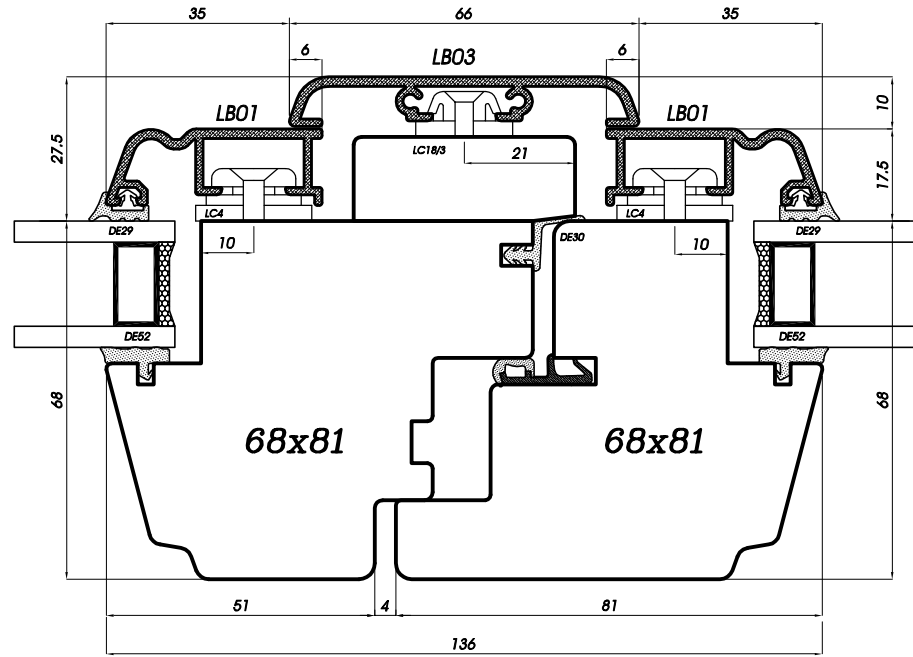
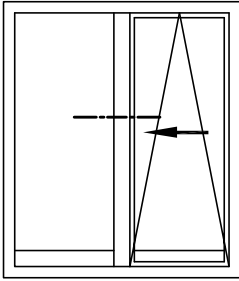

**Sezione orizzontale portafinestra con scorrevole parallelo**  
**Horizontalschnitt Parallelschiebekipptür**  
**Sección horizontal puertaventana con corredera paralela**  
**Coupe horizontale porte-fenêtre coulissante à translation**  
**Horizontal section of the window-door with parallel sliding door**

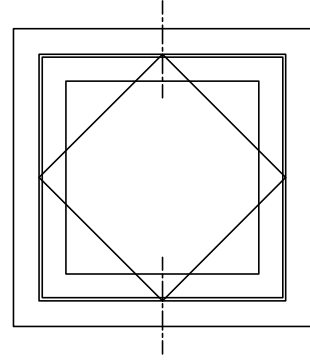
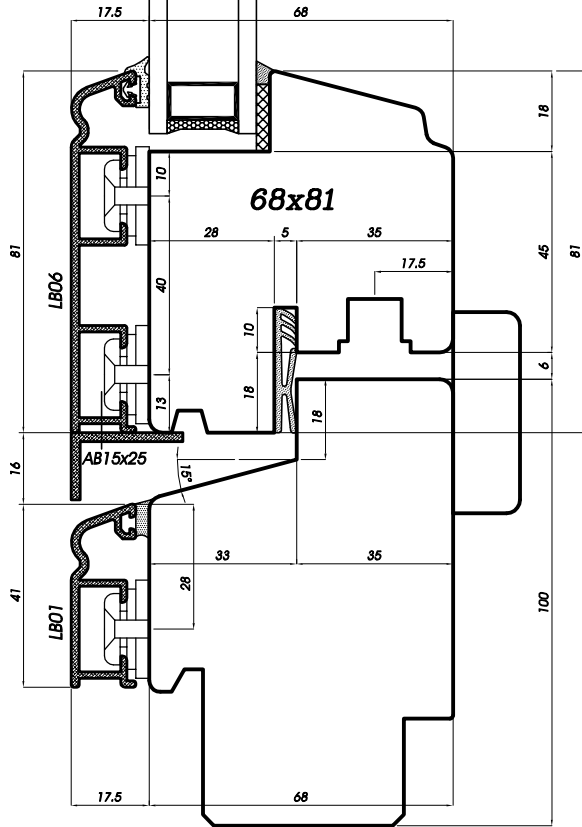
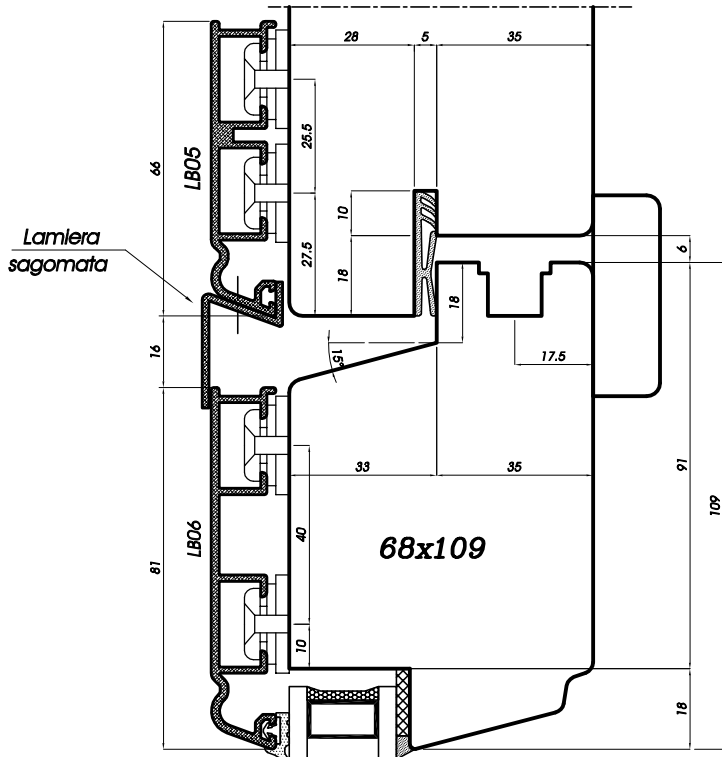

Sezione verticale bilico orizzontale  
 Vertikalschnitt Schwingflügel  
 Sección vertical de basculante horizontal  
 Coupe verticale fenêtre basculante  
 Vertical section of the horizontal bascule window

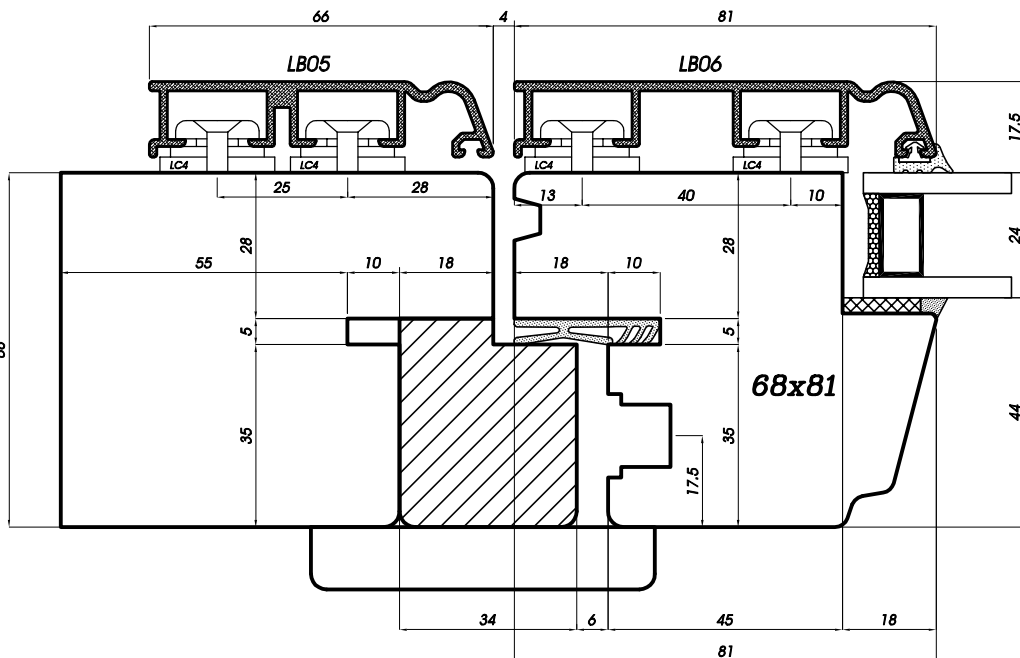
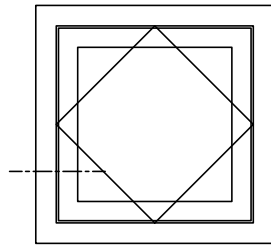
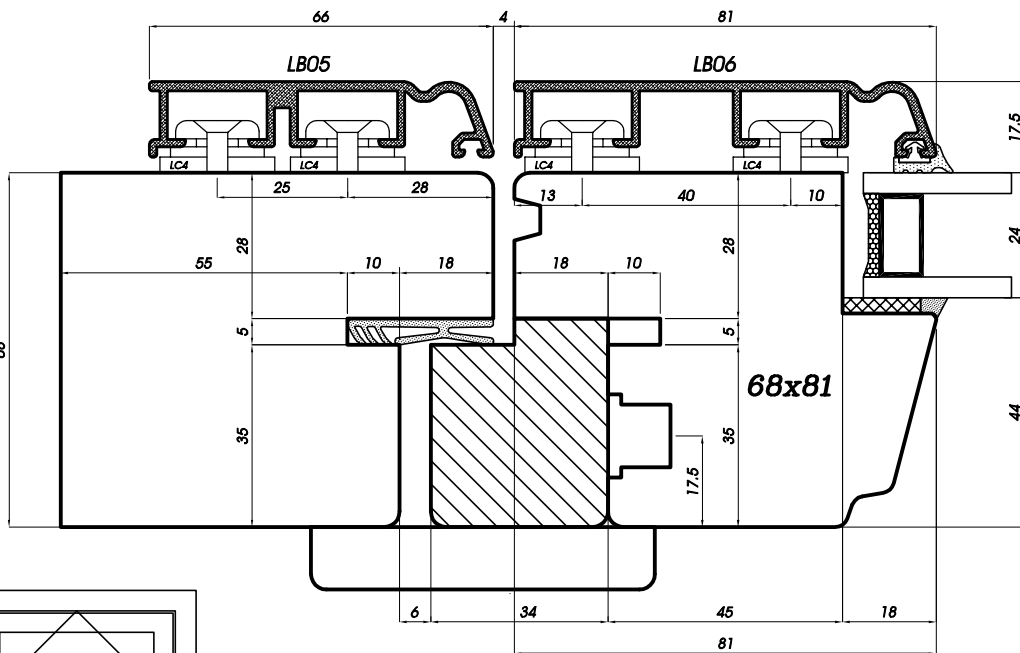
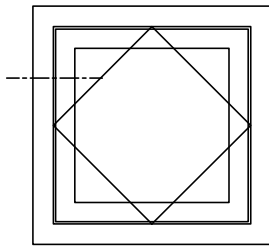

**Sezione orizzontale bilico orizzontale**  
**Horizontalschnitt Schwingflügel**  
**Sección horizontal de basculante horizontal**  
**Coupe horizontale fenêtre basculante**  
**Horizontal section of the horizontal bascule window**

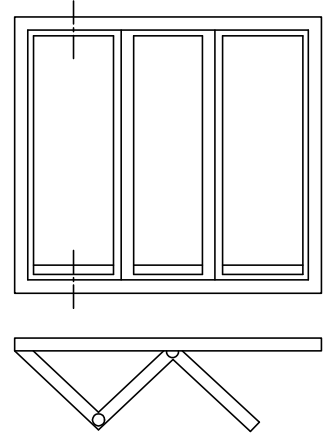
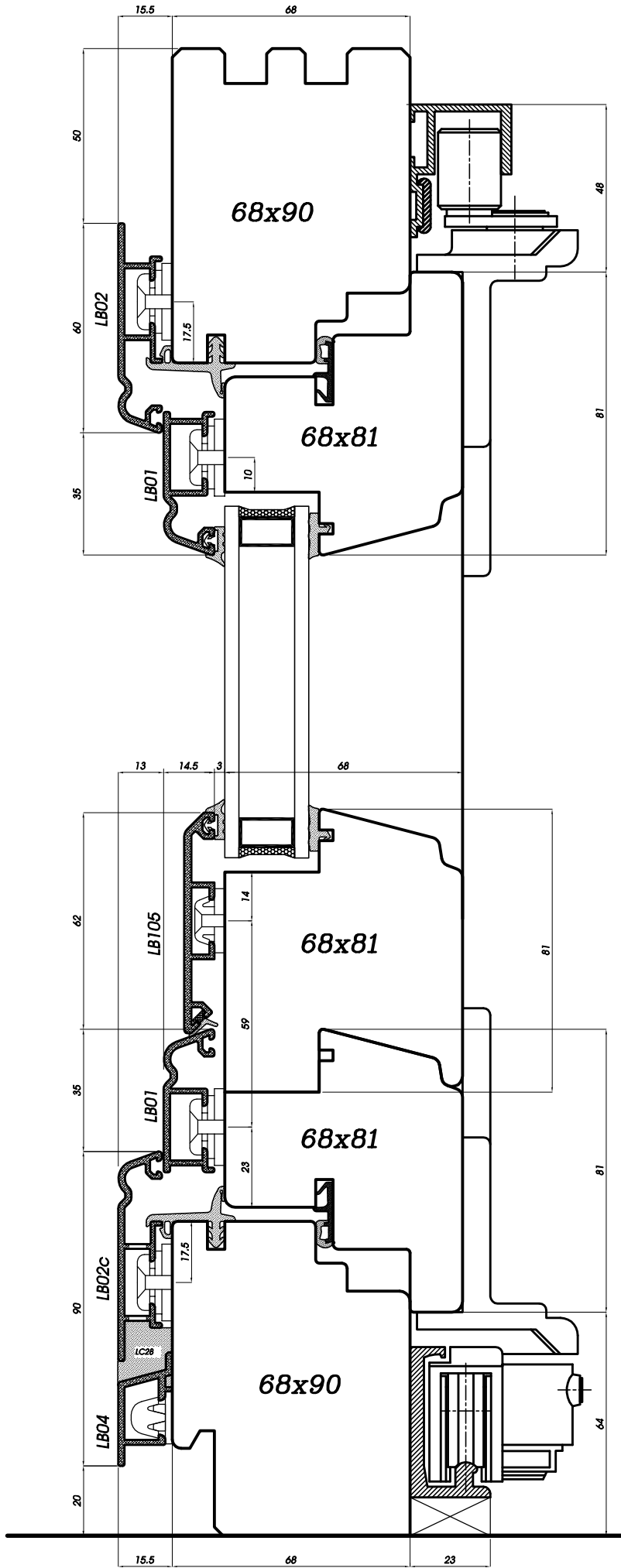

**Sezione verticale serramento a libro**  
**Vertikalschnitt Falttür**  
**Sección vertical de cerramiento a libro**  
**Coupe verticale fenêtre coulissante pliante**  
**Vertical section for sliding-folding window**



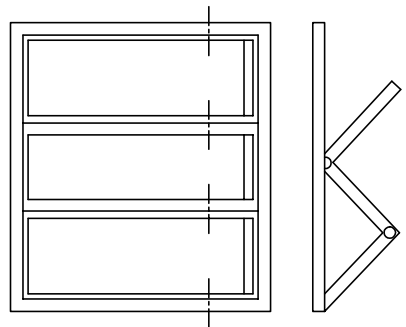
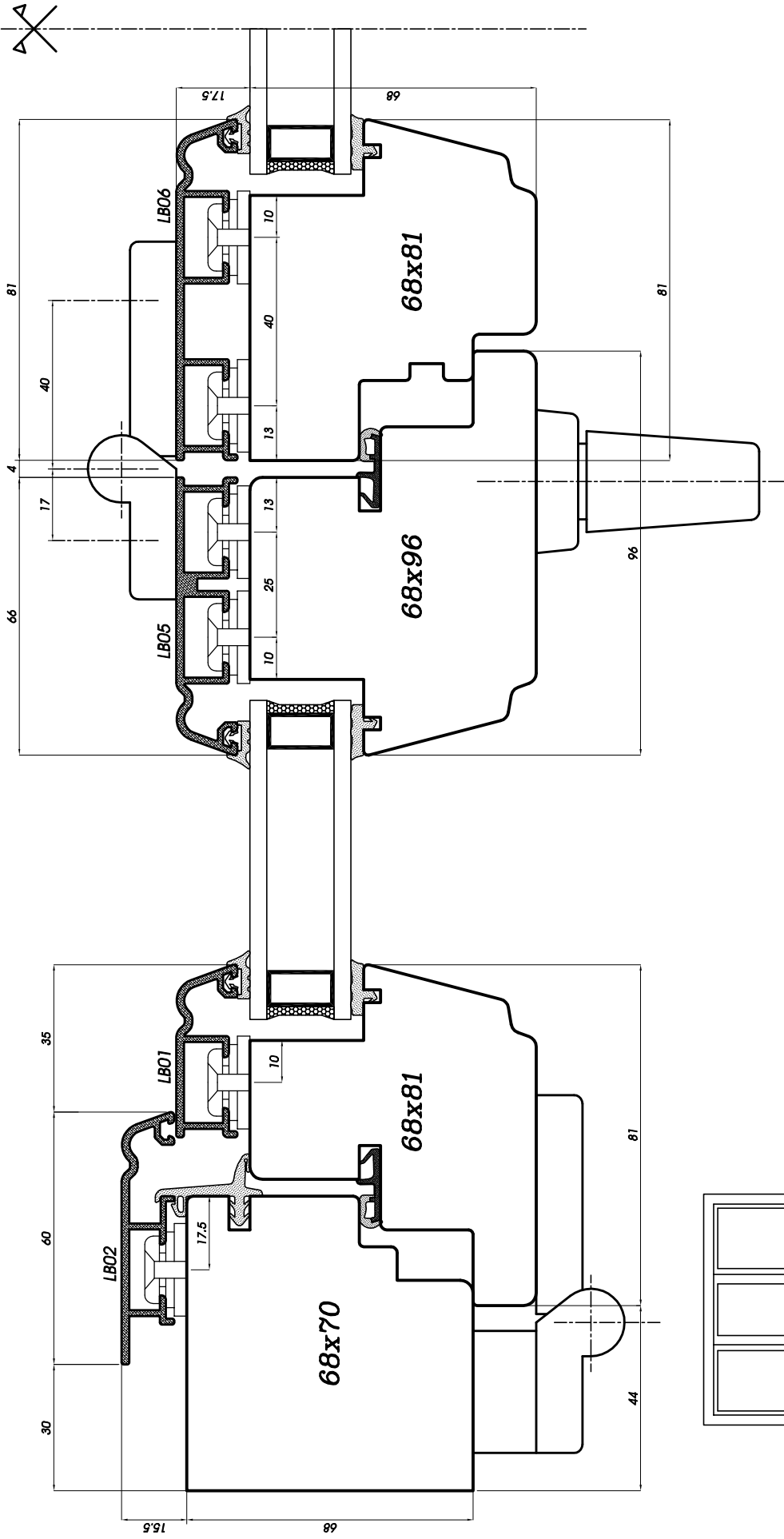

**Sezione orizzontale serramento a libro**  
**Horizontalschnitt Falttür**  
**Sección horizontal de cerramiento a libro**  
**Coupe horizontale fenêtre coulissante pliante**  
**Vertical section for sliding-folding window**

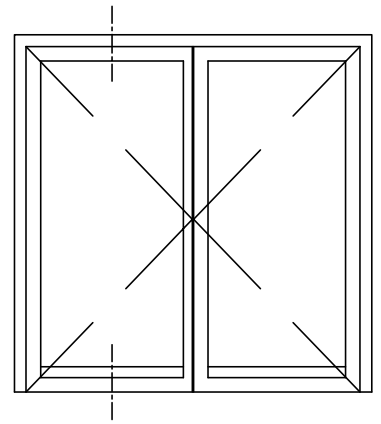
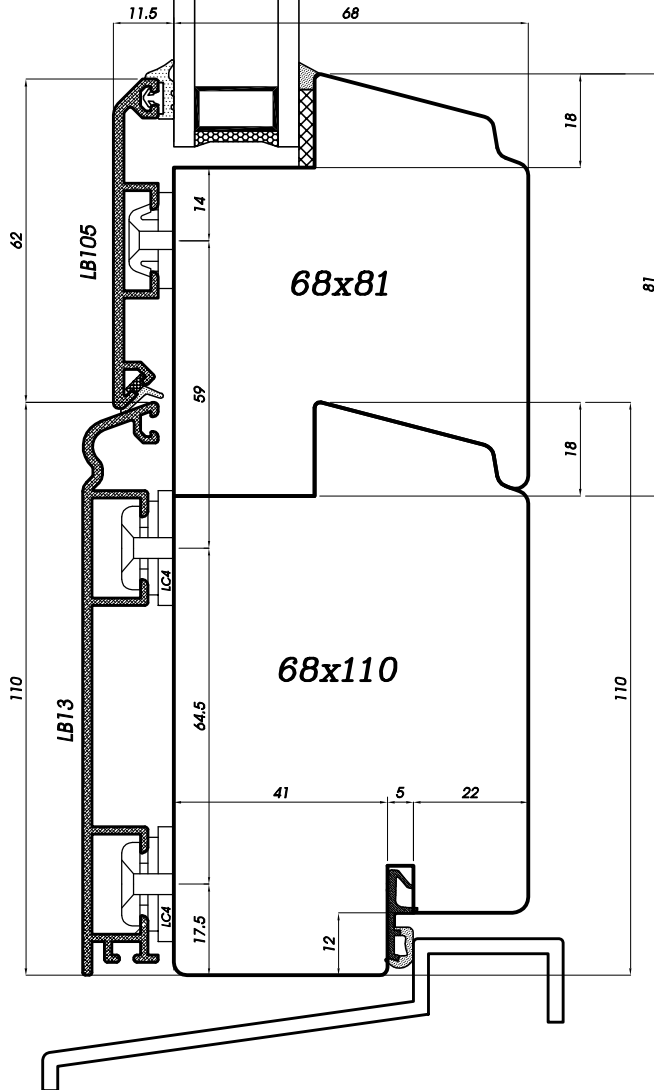
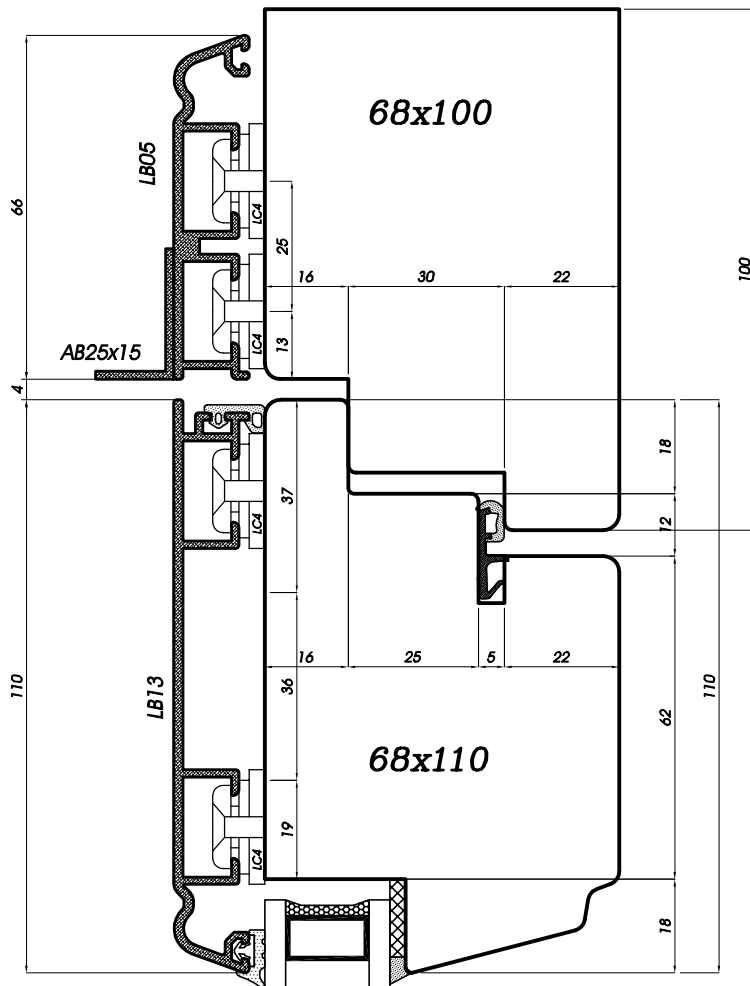

Sezione verticale serramento con apertura a sporgere  
 Vertikalschnitt Tür nach außen öffnend  
 Sección vertical de cerramiento con apertura hacia el exterior  
 Coupe verticale fenêtre avec ouverture vers l'extérieur  
 Vertical section of top-hinged window

Nuova cerniera regolabile nelle tre direzioni

FS06/7F -Argento

FS06/5F -Bronzo scuro

FS06/7F -Bianco RAL9016

FS06/9F -GREZZA

Portata: Legno tenero kg.100

Legno duro kg.120

H 20mm

Distanziali cod.1.346 6681

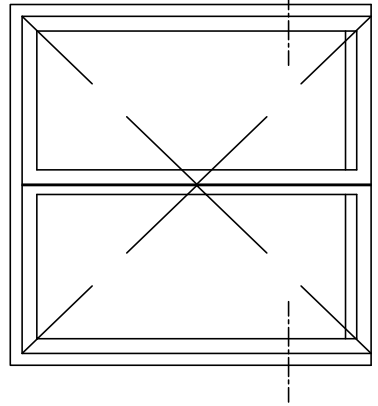
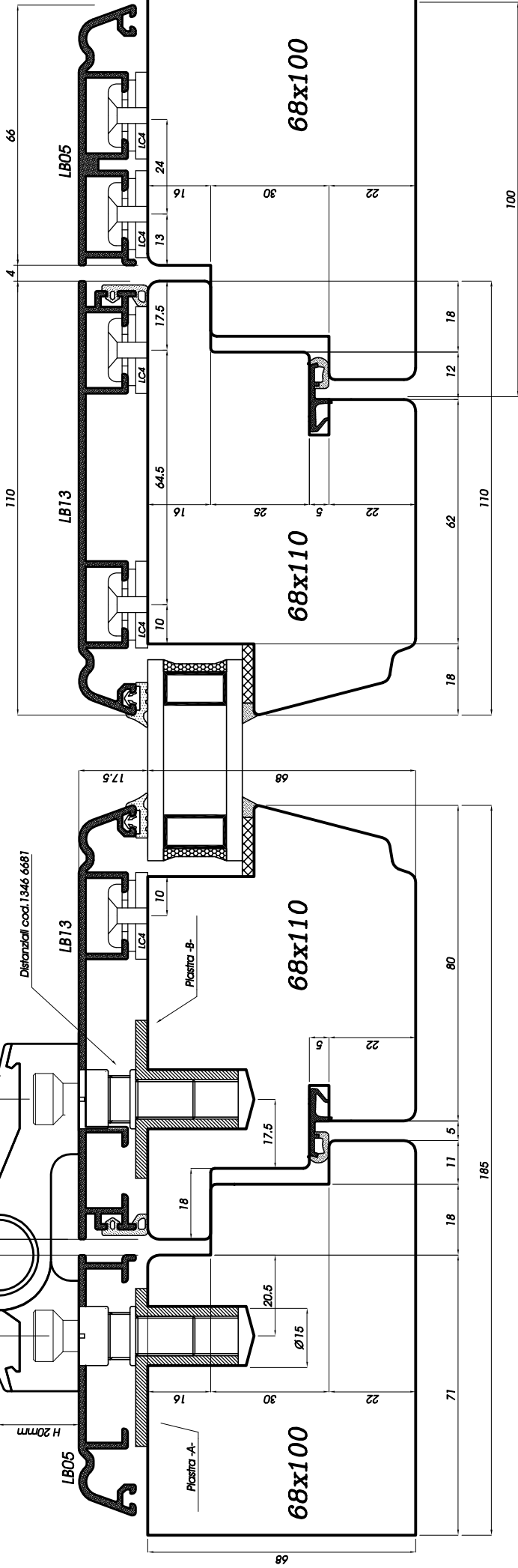

Sezione orizzontale serramento con apertura a sporgere  
 Horizontalschnitt Tür nach außen öffnend  
 Sección horizontal de cerramiento con apertura hacia el exterior  
 Coupe horizontale fenêtre avec ouverture vers l'extérieur  
 Horizontal section of top-hinged window

**ATTENZIONE:**

per il sistema 5000/S-Bronzo  
inserire sei distanziali  
cod. 1346 6681

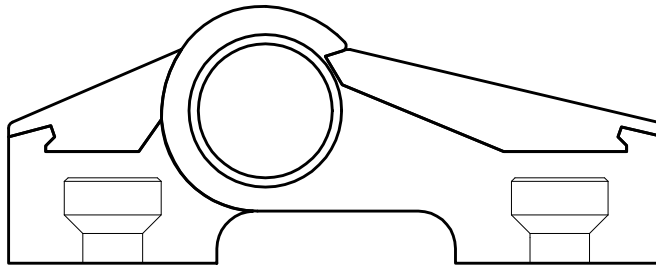

Nuova cerniera regolabile nelle tre direzioni con chiave LD30

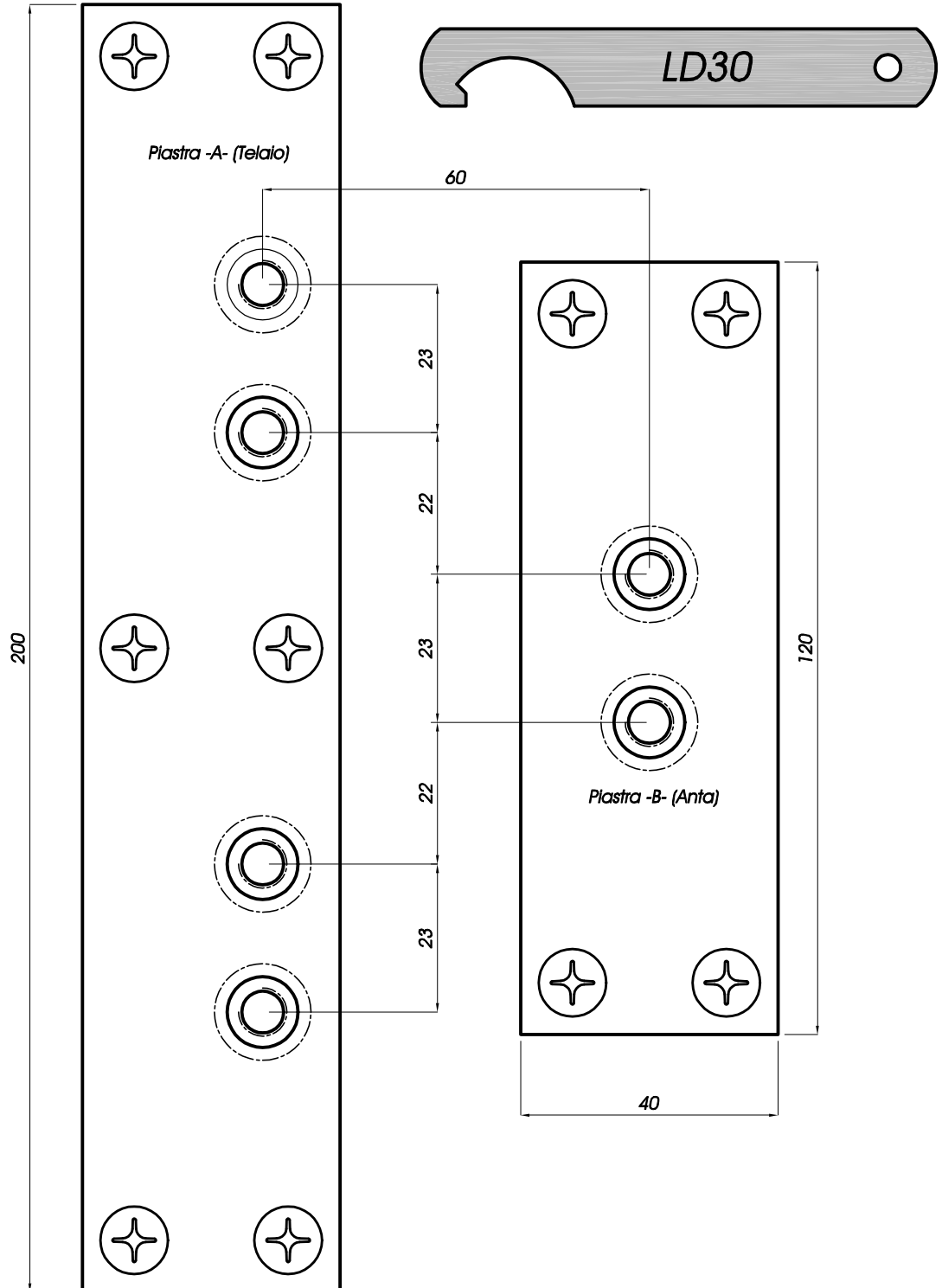

**Cerniera per apertura a sporgere**  
**Scharniere für nach Aussen aufgehende Öffnung**  
**Bisagra para apertura hacia el exterior**  
**Charnières pour ouverture vers l'extérieur**  
**H-Hinge for projected opening**

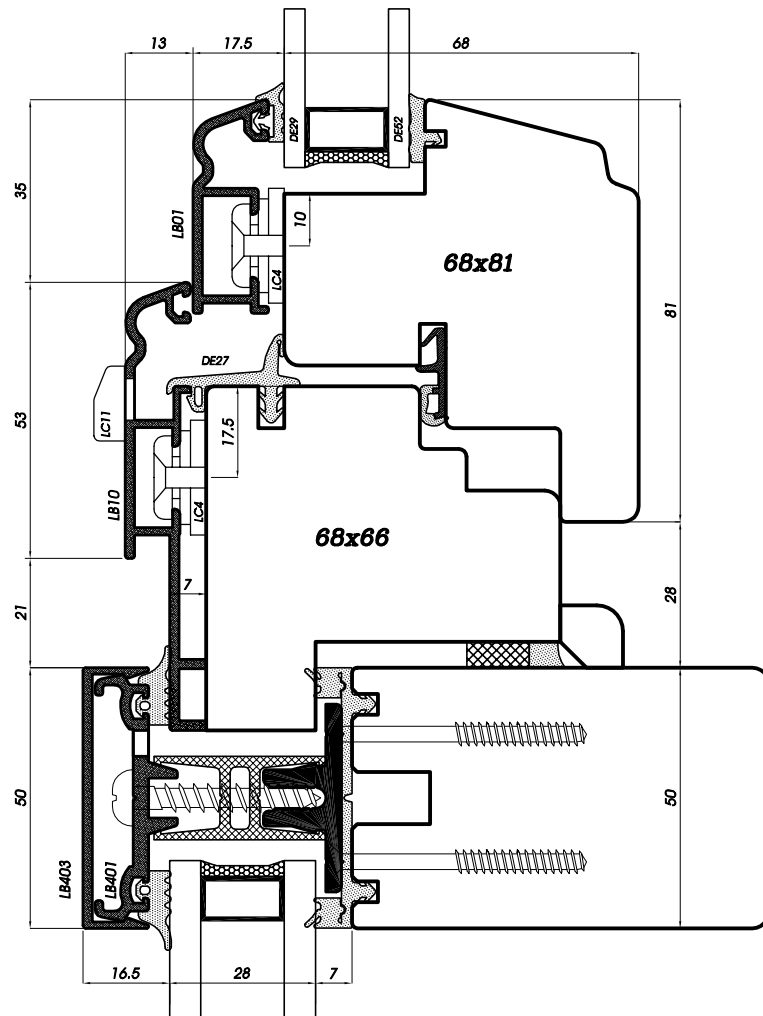
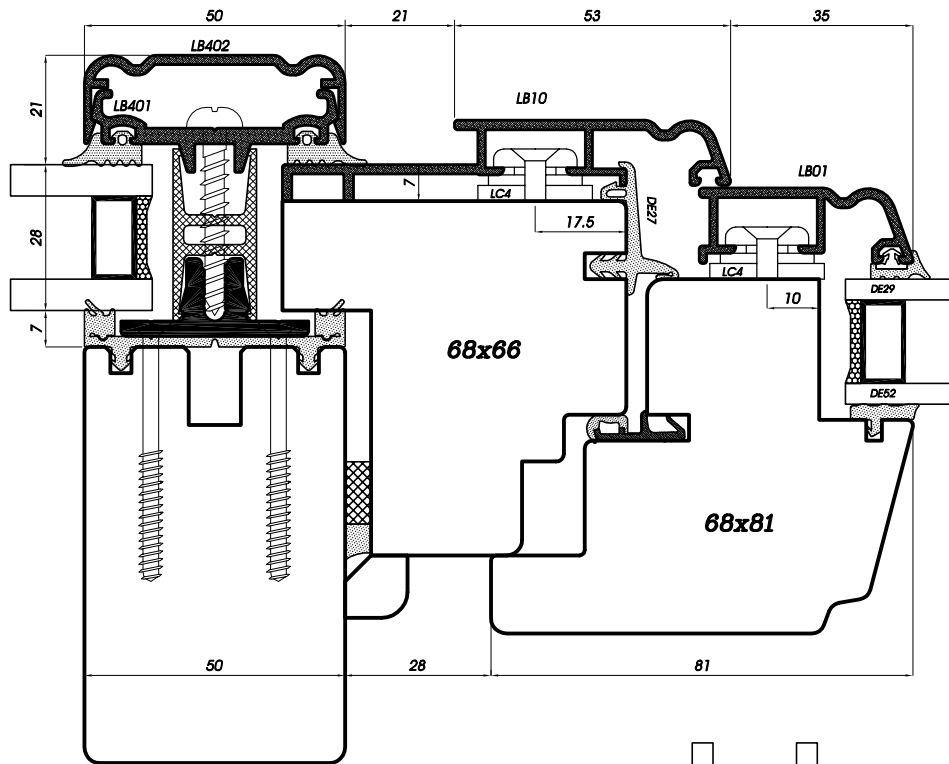

**Sezione orizzontale e verticale traversi con facciata Unitherm**  
**Horizontal- und Vertikalschnitt Fassade Unitherm - Riegel**  
**Sección horizontal y vertical travesaños con fachada Unitherm**  
**Coupe horizontale et verticale des traverses avec façade Unitherm**  
**Horizontal and vertical section of the ledgers with Unitherm curtain wall**

# NUOVO SISTEMA PER PANNELLI BUGNATI IN BRONZO

Nuovo sistema per la realizzazione e applicazione di pannelli bugnati su misura

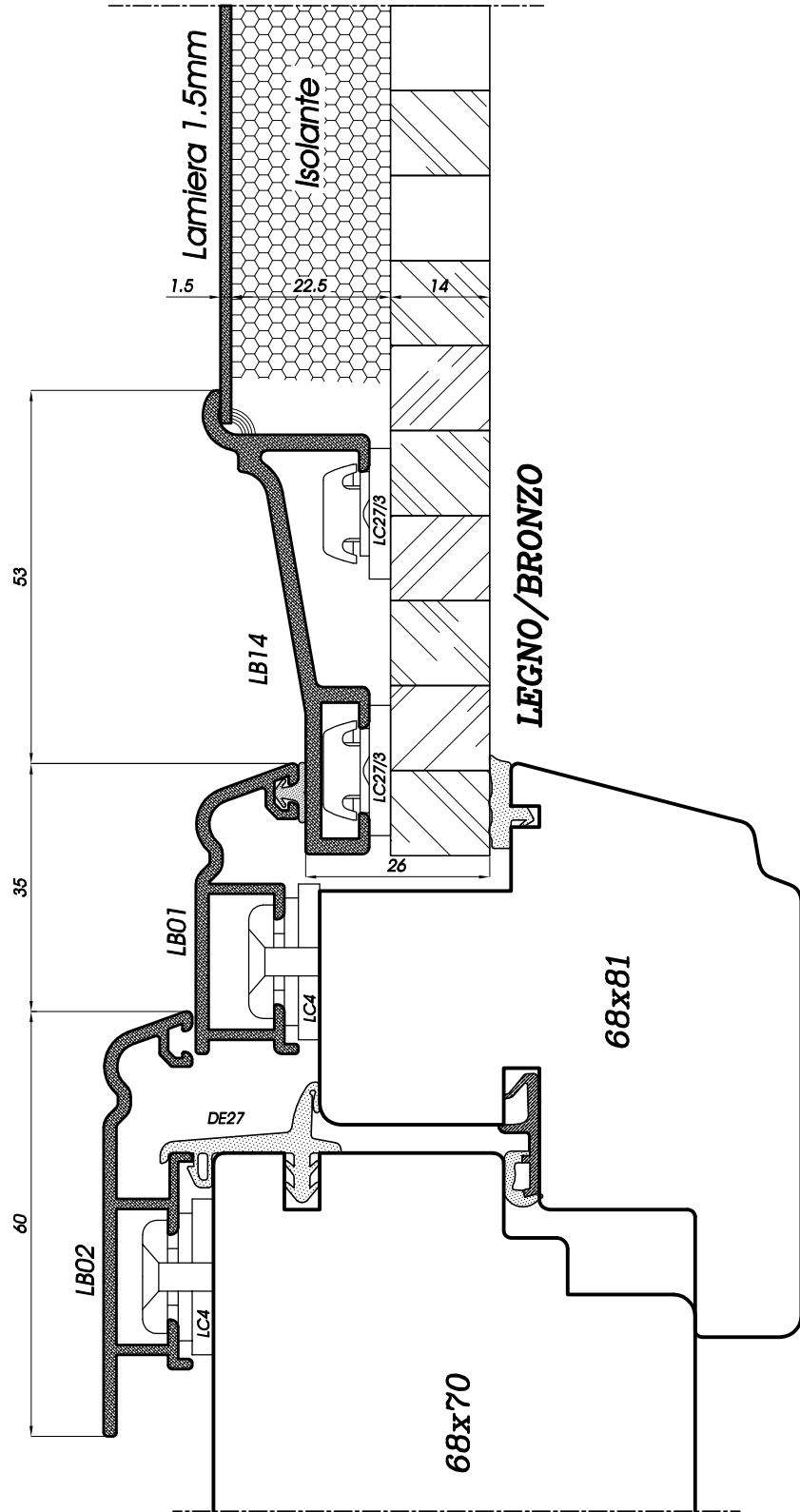

Pannelli bugnati su misura con profilo LB14  
 Profilierte Paneelen auf Mass mit Profil LB14  
 Paneles almohadillados a medida con perfil LB14  
 Panneaux moulurés sur mesure avec profil LB14  
 Raised panels on size with profile LB14

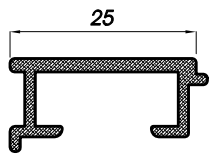

**LB08**  
L=25mm

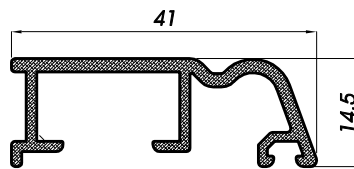

L=41mm **LB01**

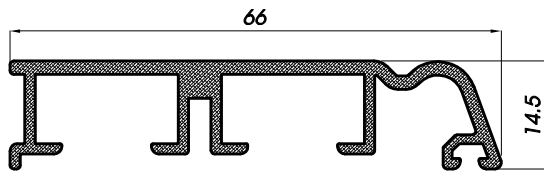

L=66mm **LB05**

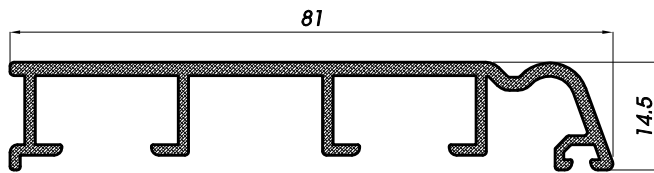

L=81mm **LB06**

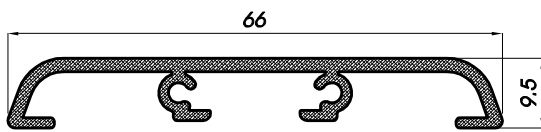

L=66mm **LB03**  
con terminale LC247

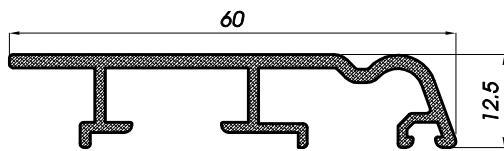

L=60mm **LB02** **LB02c**  
con asole  
scarico acqua

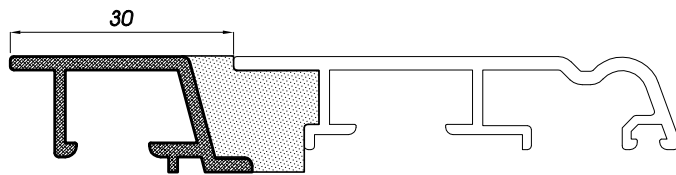

**LC28** Terminale  
in gomma

L=30mm **LB04**

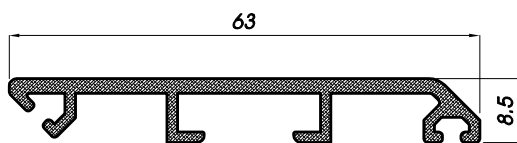

L=62mm **LB105**  
MODULO

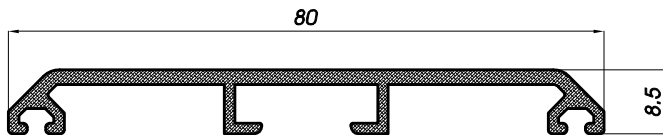

L=80mm **LB106**

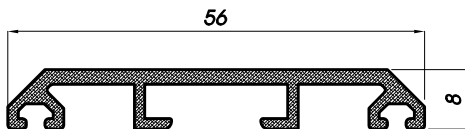

L=56mm **LB107**

**Profili in bronzo**  
**Bronzprofile**  
**Perfiles de bronce**  
**Profils en bronze**  
**Bronze profiles**

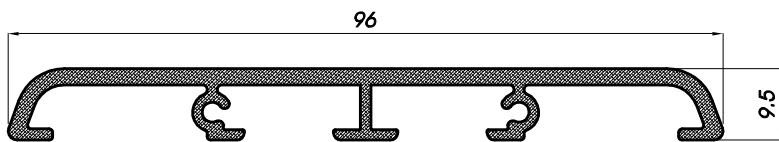

L=96mm **LB15**  
con terminale LC35

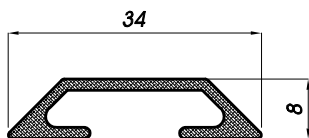

**LB198**  
L=34mm

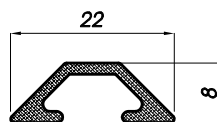

**LB11**  
L=22mm

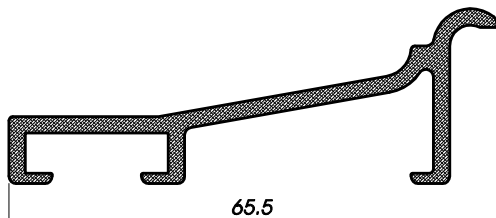

**LB14**  
L=65.5mm

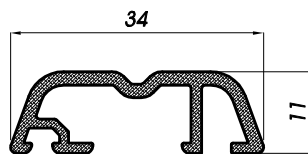

**LB07**  
L=34mm

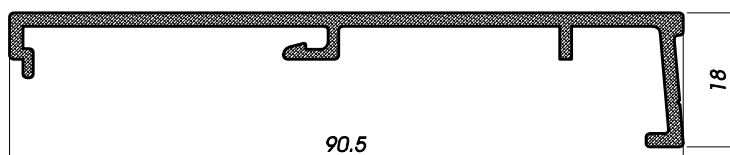

L=90.5mm **LB12**  
PER SPESSORE LEGNO 68mm

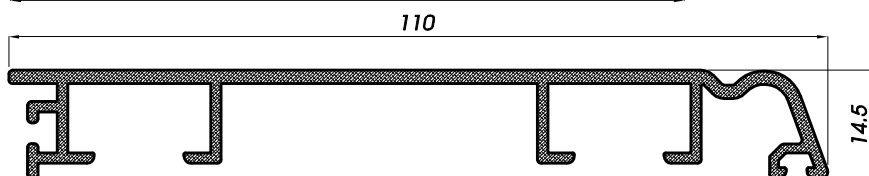

L=110mm **LB13**

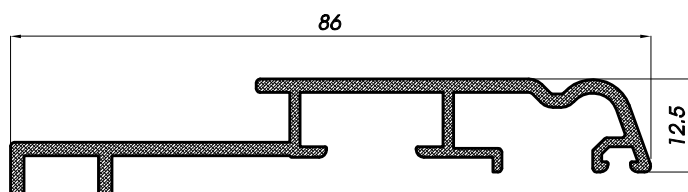

L=86mm **LB10**

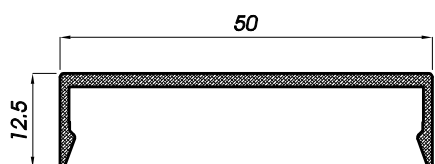

**LB403**

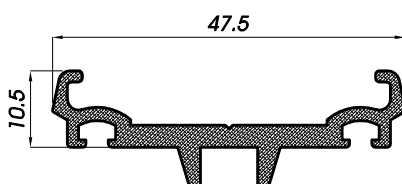

**LB401**

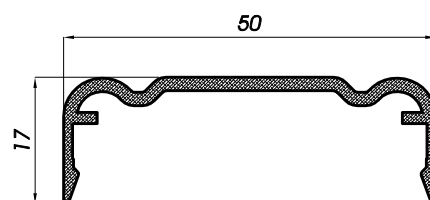

**LB402**

### PROFILI ANGOLARI IN BRONZO



**AB25x15** 25x15x2

**AB40x20** 40x20x2

### PROFILI PIANI IN BRONZO



**PB20x2** 20x2

**PB40x2** 40x2

Profili in bronzo  
Bronzprofile  
Perfiles de bronce  
Profils en bronze  
Bronze profiles