



J



PARAMOUNT POOLS
ECOLOGICAL PRODUCTS FOR
POOL MAINTENANCE

PARAMOUNT POOLS
PRODUCTOS ECOLOGICOS PARA
EL MANTENIMIENTO DE LA PISCINA

PARAMOUNT POOLS
PRODUITS ÉCOLOGIQUES POUR
L'ENTRETIEN DE PISCINE

2016

PV3 - IN FLOOR AUTOMATIC CLEANING AND CIRCULATION SYSTEM FOR CONCRETE POOLS
PV3 - SISTEMA AUTOMÁTICO INTEGRADO DE LIMPIEZA Y CIRCULACIÓN PISCINAS DE HORMIGÓN
PV3 - SYSTÈME DE NETTOYAGE ET CIRCULATION AUTOMATIQUE INTEGRE POUR PISCINES BETON



Code Código Code	Product Description Descripción Producto Désignation des Articles	Case Qty. Unid. Caja Unit. Boîte
------------------------	---	--

	PV3 - Complete Cleaning and Circulation System PV3 - Sistema Completo de Limpieza y Circulación PV3 - Système Complete de Nettoyage et Circulation	
UEP V3I 630 CS	1 Complete System PV3 1 Sistema Completo PV3 1 Système Complete PV3	1

	Components Componentes Composants	
UEV D06 100 01	Water Valve Paramount 6 Ports Valvula Distribuidora - 6 puertos Vanne de Commande Paramount 6 Sorties	1
UEP V3I 630 01	PV3 Nozzle Complete PV3 Boquilla Completa PV3 Buse Complete	12
UEP V3H 000 01	Installation Tool PV3 Herramienta Instalación PV3 Clef Special de Montage PV3	1
UEM DX2 H75 01	Main Drain Active Paramount Sumidero Activo MDX Bonde de Fond Active Paramount	1
UEM DX0 DS0 00	MDX - Security Screwdriver MDX - Destornillador Seguridad MDX - Tournevis de Sécurité	1
UEM DX0 TH0 00	MDX - Construction Cover for Concrete MDX - Tapa de construcción para gunitado MDX - Couverture de Construction por beton	1
UEC RM6 300 01	Debris Canister "ADR" Cesta de Recogida Piege a Feuilles "ADR"	1
UEC RT6 300 01	Debris Canister - Deck Lid & Ring Cesta de Recogida - Tapa registro con marco Piege a Feuilles - Couverture avec cadre et anneau	1

PV3 COMPLETE SYSTEM

*PV3 system has been especially designed for concrete pools. Its components are:

- 1 Paramount Water Valve 6 ports
- 12 complete Nozzles (bodies and jets)
- 1 Installation Tool
- 1 Active Main Drain-MDX-for concrete
- 1 Debris Canister with Cover

SISTEMA COMPLETO PV3

*El Sistema de limpieza y circulación automático integrado PV3 es diseñado especialmente para piscinas de hormigón y se compone básicamente de:

- 1 Válvula Distribuidora - 6 puertos
- 12 Boquillas completas (cuerpos e impulsores)
- 1 Herramienta de instalación
- 1 Sumidero Activo MDX - hormigón
- 1 Cesta de Recogida con cubierta

SYSTÈME COMPLET PV3

*Le système de nettoyage intègre PV3 est spécialement étudié pour les piscines béton. Il se compose de:

- 1 Vanne de Commande Paramount—6 sorties
- 12 Buses Complètes (niches et jets)
- 1 Clef Spéciale de Montage
- 1 Bonde de Fond Active- MDX-pour béton
- 1 Piège a Feuilles "ADR" avec Couverture

1 PV3 Complete System
1 Sistema Completo PV3
1 Systeme Complet PV3



8 colors available
8 colores disponibles
8 couleurs disponibles



CYCLEAN - IN FLOOR AUTOMATIC CLEANING AND CIRCULATION SYSTEM FOR CONCRETE POOLS
CYCLEAN - SISTEMA AUTOMÁTICO INTEGRADO DE LIMPIEZA Y CIRCULACIÓN PISCINAS DE HORMIGÓN
CYCLEAN - SYSTÈME DE NETTOYAGE ET CIRCULACION AUTOMATIQUE INTEGRE POUR PISCINES BETON



Code Código Code	Product Description Descripción Producto Désignation des Articles	Case Qty. Unid. Caja Unit. Boîte
------------------------	---	--

	CYCLEAN - Complete Cleaning System CYCLEAN - Sistema Completo de Limpieza CYCLEAN - Système Complete de Nettoyage	
UEC YI6 300 CS	1 Complete System CYCLEAN 1 Sistema Completo CYCLEAN 1 Système Complete CYCLEAN	1

	Components Componentes Composants	
UEV D06 100 01	Water Valve Paramount 6 Ports Valvula Distribuidora - 6 puertos Vanne de Commande Paramount 6 Sorties	1
UEC YI6 300 01	CYCLEAN Nozzle Complete CYCLEAN Boquilla Completa CYCLEAN Buse Complete	12
UEC YH0 000 01	Installation Tool CYCLEAN Herramienta Instalación CYCLEAN Clef Special de Montage CYCLEAN	1
UEM DX2 H75 01	Main Drain Active Paramount Sumidero Activo MDX Bonde de Fond Active Paramount	1
UEM DX0 DS0 00	MDX - Security Screwdriver MDX - Destornillador Seguridad MDX - Tournevis de Sécurité	1
UEM DX0 TH0 00	MDX - Construction Cover for Concrete MDX - Tapa de construcción para gunitado MDX - Couverture de Construction por beton	1
UEC RM6 300 01	Debris Canister "ADR" Cesta de Recogida Piege a Feuilles "ADR"	1
UEC RT6 300 01	Debris Canister - Deck Lid & Ring Cesta de Recogida - Tapa registro con marco Piege a Feuilles - Couverture avec cadre et anneau	1

CYCLEAN COMPLETE SYSTEM

*CYCLEAN system has been especially designed for concrete pools. Its components are:

- 1 Paramount Water Valve 6 ports
- 12 complete Nozzles (bodies and jets)
- 1 Installation Tool
- 1 Active Main Drain-MDX-for concrete
- 1 Debris Canister with Cover

SISTEMA COMPLETO CYCLEAN

*El Sistema de limpieza y circulación automático integrado CYCLEAN es diseñado especialmente para piscinas de hormigón y se compone básicamente de:

- 1 Válvula Distribuidora - 6 puertos
- 12 Boquillas completas (cuerpos e impulsores)
- 1 Herramienta de instalación
- 1 Sumidero Activo MDX - hormigón
- 1 Cesta de Recogida con cubierta

SYSTÈME COMPLET CYCLEAN

*Le système de nettoyage intègre CYCLEAN est spécialement étudié pour les piscines béton. Il se compose de:

- 1 Vanne de Commande Paramount—6 sorties
- 12 Buses Complètes (niches et jets)
- 1 Clef Spéciale de Montage
- 1 Bonde de Fond Active- MDX-pour béton
- 1 Piège a Feuilles "ADR" avec Couverture

1 CYCLEAN Complete System
1 Sistema Completo CYCLEAN
1 Systeme Complet CYCLEAN



8 colors available
8 colores disponibles
8 couleurs disponibles



MDX²



POOL VALET - IN FLOOR AUTOMATIC CLEANING AND CIRCULATION SYSTEM FOR CONCRETE POOLS
POOL VALET - SISTEMA AUTOMÁTICO INTEGRADO DE LIMPIEZA Y CIRCULACIÓN PISCINAS DE HORMIGÓN
POOL VALET - SYSTÈME DE NETTOYAGE ET CIRCULATION AUTOMATIQUE INTEGRE POUR PISCINES BETON



Code Código Code	Product Description Descripción Producto Désignation des Articles	Case Qty. Unid. Caja Unit. Boîte
------------------------	---	--

	Pool Valet Pool Valet Pool Valet	
UEP VBC 200 CS	1 Complete System Pool Valet 1 Sistema Completo Pool Valet 1 Système Complete Pool Valet	1

	Components Componentes Composants	
UEM DX2 H75 01	Main Drain Active Paramount Sumidero Activo MDX Bonde de Fond Active Paramount	1
UEV D06 100 01	Water Valve Paramount 6 Ports Valvula Distribuidora - 6 puertos Vanne de Commande Paramount 6 Sorties	1
UEC RM6 300 01	Debris Canister "ADR" Cesta de Recogida Piege a Feuilles "ADR"	1
UEP VHM 000 01	Installation Tool Pool Valet Herramienta Instalación Pool Valet Clef Special de Montage Pool Valet	1
UEP VBC 200 01	Pool Valet Nozzle Complete Pool Valet Boquilla Completa Pool Valet Buse Complete	12
UEM DX0 DS0 00	MDX - Security Screwdriver MDX - Destornillador Seguridad MDX - Tournevis de Sécurité	1
UEM DX0 TH0 00	MDX - Construction Cover for Concrete MDX - Tapa de construcción para gunitado MDX - Couverture de Construction por beton	1
UEC RT6 300 01	Debris Canister - Deck Lid & Ring Cesta de Recogida - Tapa registro con marco Piege a Feuilles - Couverture avec cadre et anneau	1

POOL VALET COMPLETE SYSTEM

*Pool Valet system has been especially designed for concrete pools. Its components are:

- 1 Paramount Water Valve 6 ports
- 12 complete Nozzles (bodies and jets)
- 1 Installation Tool
- 1 Active Main Drain-MDX-for concrete
- 1 Debris Canister with Cover

SISTEMA COMPLETO POOL VALET

*El Sistema de limpieza y circulación automático integrado Pool Valet es diseñado especialmente para piscinas de hormigón y se compone básicamente de:

- 1 Válvula Distribuidora - 6 puertos
- 12 Boquillas completas (cuerpos e impulsores)
- 1 Herramienta de instalación
- 1 Sumidero Activo MDX - hormigón
- 1 Cesta de Recogida con cubierta

SYSTÈME COMPLET POOL VALET

*Le système de nettoyage intègre Pool Valet est spécialement étudié pour les piscines béton. Il se compose de:

- 1 Vanne de Commande Paramount—6 sorties
- 12 Buses Complètes (niches et jets)
- 1 Clef Spéciale de Montage
- 1 Bonde de Fond Active- MDX-pour béton
- 1 Piège a Feuilles "ADR" avec Couverture

1 Pool Valet Complete System
 1 Sistema Completo Pool Valet
 1 Systeme Complet Pool Valet



x 1



x 1

MDX²



x 1



x 12

PCC 2000 - IN FLOOR AUTOMATIC CLEANING AND CIRCULATION SYSTEM PROFESIONAL FOR CONCRETE POOLS
PCC 2000 - SISTEMA DE LIMPIEZA Y CIRCULACIÓN AUTOMÁTICO PROFESIONAL PARA PISCINA DE HORMIGÓN
PCC 2000 - SYSTÈME DE NETTOYAGE ET CIRCULACION AUTOMATIQUE PROFESSIONNEL PISCINES DE BÉTON



Code Código Code	Product Description Descripción Producto Désignation des Articles	Case Qty. Unid. Caja Unit. Boîte
	PCC 2000 - PROFESSIONAL SYSTEM PCC 2000 - SISTEMA PROFESIONAL PCC 2000 - SYSTEME PROFESSIONNEL	
UEP CCI R63 CS	1 PCC 2000 Complete System 1 Sistema Completo PCC 2000 1 Systeme Complete PCC 2000	1
	Components Componentes Composants	
UEV D06 100 01	Water Valve Paramount 6 Ports Valvula Distribuidora - 6 puertos Vanne de Commande Paramount 6 Sorties	1
UEP CCI R63 01	PCC 2000 Kit Floor Nozzle Complete - Rotating PCC 2000 Kit Boquilla Suelo Completo - Rotativo PCC 2000 Kit Buse Sol Complete - Rotatif	3
UEP CCI F63 01	PCC 2000 Kit Floor Nozzle Complete - Fixed PCC 2000 Kit Boquilla Suelo Completo - Fijo PCC 2000 Kit Buse Sol Complete - Fixe	2
UEP CCB E63 01	PCC 2000 Kit Step Nozzle (Body + Nozzle) PCC 2000 Kit Boquilla Escalon (Cuerpo + Impulsor) PCC 2000 Kit Buse Escalier (Niche + Jet)	4
UEP CCH IS0 01	Installation Tool PCC 2000 - Floor Herramienta Instalación PCC 2000 - Suelo Clef Special de Montage PCC 2000 - Sol	1
UEP CCH IE0 01	Installation Tool PCC 2000 - Step Herramienta Instalación PCC 2000 - Escalon Clef Special de Montage PCC 2000 - Escalier	1
UEM DX2 H75 01	MDX Main Drain Active for Concrete Sumidero Activo MDX para Hormigón Bonde de Fond Active MDX pour Béton	1
UEM DX0 DS0 00	MDX - Security Screwdriver MDX - Destornillador Seguridad MDX - Tournevis de Sécurité	1
UEM DX0 TH0 00	MDX - Construction Cover for Concrete MDX - Tapa de construcción para Hormigón MDX - Couverture de Construction pour Béton	1
UEC RM6 300 01	Debris Canister "ADR" - Metric Cesta de Recogida - Metrica Piège a Feuilles "ADR" - Metrique	1
UEC RT6 300 01	Debris Canister - Deck Lid & Ring Cesta de Recogida - Tapa registro con marco Piège a Feuilles - Couverture avec cadre et anneau	1
UED J00 001 00	Down Jet Ball - 90° down jet Bola Down Jet - chorro a 90° hacia abajo Boule Jet de Paroi - jet à 90° vers le bas	4
UEP CCT ACT 63	PCC Riser for floor Nozzles Adaptador PCC para boquillas suelo PCC Tube Adaptateur Métrique pour buse de sol	5

PCC 2000 COMPLETE SYSTEM

*PCC 2000 system it is the best designed professional System for concrete pools. Its components are:

- 1 Paramount Water Valve 6 ports
- 3 Rotating Floor Nozzles Kit
- 2 Fixed Floor Nozle Kit
- 4 Step Nozzle Kit
- 4 Down Jet Ball for Wall Returns
- 1 Active Main Drain-MDX
- 1 Debris Canister w/cover
- 1 Installation Tool Floor
- 1 Installation Tool Step
- 5 Metric adaptors for floor nozzles

PCC 2000 SYSTEMA COMPLETO

*El Sistema Automático Integrado de Limpieza y Circulación - PCC 2000 es el mejor Sistema profesional diseñado especialmente para piscinas de hormigón y se compone básicamente de:

- 1 Válvula Distribuidora - 6 Puertos
- 3 Kit Boquillas Rotativas - Suelo
- 2 Kit Boquillas Fijas - Suelo
- 4 Kit Boquillas Escalones
- 4 Bolas Down Jet - para los retornos de pared
- 1 Sumidero Activo - MDX con/tapa/destornillador
- 1 Cesta de Recogida con/cubierta
- 1 Herramienta de Instalación Suelo
- 1 Herramienta de Instalación Escalón
- 5 Adaptadores métricos boquillas suelo

PCC 2000 SYSTEME COMPLETE

*Le système de nettoyage intégré PCC 2000 est spécialement étudié pour les piscines de béton. Il se compose de:

- 1 Vanne de Commande Paramount—6 sorties
- 3 Kit Buses Rotatives - Sol
- 2 Kit Buses Fixes - Sol
- 4 Kit Buses Escalier
- 4 Boule Jet de Paroi
- 1 Bonde de Fond Active- MDX avec/couv./torn.
- 1 Piège a Feuilles "ADR" avec couverture
- 1 Clef Spéciale de Montage Sol
- 1 Clef Spéciale de Montage Escalier
- 5 Adapter métriques pour buses de sol.

8 colors available
8 colores disponibles
8 couleurs disponibles



VANQUISH - IN FLOOR AUTOMATIC CLEANING AND CIRCULATION SYSTEM FOR LINER POOLS
VANQUISH - SISTEMA DE LIMPIEZA Y CIRCULACIÓN AUTOMÁTICO INTEGRADO PARA PISCINAS LINER
VANQUISH - SYSTÈME DE NETTOYAGE ET CIRCULACION AUTOMATIQUE INTEGRE POUR PISCINES LINER



Code Código Code	Product Description Descripción Producto Désignation des Articles	Case Qty. Unid. Caja Unit. Boîte
------------------------	---	--

	Vanquish Vanquish Vanquish	
UEV ANQ KR0 CS	1 Vanquish Complete System 1 Sistema Completo Vanquish 1 Systeme Complet Vanquish	1

	Components Componentes Composants	
EUM DX2 L75 01	Main Drain Active for Liner Sumidero Activo MDX para Liner Bonde de Fond Active por Liner	1
UEV D06 100 01	Water Valve Paramount 6 Ports Valvula Distribuidora - 6 puertos Vanne de Commande Paramount 6 Sorties	1
UEC RM6 300 01	Debris Canister "ADR" Cesta de Recogida Piege a Feuilles "ADR"	1
UEV ANQ HSO 00	Installation Tool Vanquish Herramienta Instalación Vanquish Clef Special de Montage Vanquish	1
UEV ANQ KR0 01	Vanquish Kit Nozzle Complete Vanquish Kit Boquilla Completa Vanquish Kit Buse Complete	4
UEM DX0 DS0 00	MDX - Security Screwdriver MDX - Destornillador Seguridad MDX - Tournevis de Sécurité	1
UEM DX0 TL0 00	MDX - Construction Cover for Liner MDX - Tapa de construcción para Liner MDX - Couverture de Construction por Liner	1
UEC RT6 300 01	Debris Canister - Deck Lid & Ring Cesta de Recogida - Tapa registro con marco Piege a Feuilles - Couverture avec cadre et anneau	1
UED J00 001 00	Down Jet Ball - 90° down jet Bola Down Jet - chorro a 90° hacia abajo Boule Jet de Paroi - jet à 90° vers le bas	6

VANQUISH COMPLETE SYSTEM

*Vanquish system has been especially designed for liner pools. Its components are:

- 1 Paramount Water Valve 6 ports
- 4 Rotating Nozzles Kit
- 6 Wall Returns
- 1 Active Main Drain-MDX-for liner
- 1 Debris Canister w/cover
- 1 Installation Tool

VANQUISH SYSTEME COMPLET

*El Sistema Automático Integrado de Limpieza y Circulación - Vanquish es diseñado especialmente para piscinas cubiertas por Liner y se compone básicamente de:

- 1 Válvula Distribuidora - 6 Puertos
- 4 Kit Boquillas Rotativas
- 6 Bolas Down Jet
- 1 Sumidero Activo - MDX para liner
- 1 Cesta de Recogida con/cubierta
- 1 Herramienta de Instalación

VANQUISH SYSTEME COMPLET

*Le système de nettoyage integre Vanquish est spécialement étudie pour les piscines liner. Il se compose de:

- 1 Vanne de Commande Paramount—6 sorties
- 4 Kit Buses Rotatives
- 6 Jets de Paroi
- 1 Bonde de Fond Active- MDX- pour liner
- 1 Piege a Feuilles "ADR" avec couverture
- 1 Clef Spéciale de Montage

1 Complete System Vanquish
1 Sistema Completo Vanquish
1 Systeme Complete Vanquish



8 colors available
8 colores disponibles
8 couleurs disponibles



VANTAGE - IN FLOOR AUTOMATIC CLEANING AND CIRCULATION SYSTEM FOR FIBERGLASS POOLS
VANTAGE - LIMPIEZA Y CIRCULACIÓN AUTOMÁTICA INTEGRADA PARA PISCINAS PREFABRICADAS
VANTAGE - SYSTÈME DE NETTOYAGE ET CIRCULACION AUTOMATIQUE INTEGRE PISCINES FIBRE DE VERRE



Code Código Code	Product Description Descripción Producto Désignation des Articles	Case Qty. Unid. Caja Unit. Boîte
------------------------	---	--

	Vantage Vantage Vantage	
UEV ANT KR0 CS	Complete System Vantage Sistema Completo Vantage Systeme Complet Vantage	1

	Components Componentes Composants	
EUM DX2 P75 01	Main Drain Active for Fiberglass Sumidero Activo MDX para piscinas prefabricadas Bonde de Fond Active pour Fibre de Verre	1
UEV D06 100 01	Water Valve Paramount 6 Ports Valvula Distribuidora - 6 puertos Vanne de Commande Paramount 6 Sorties	1
UEC RM6 300 01	Debris Canister "ADR" Cesta de Recogida Piege a Feuilles "ADR"	1
UEV ANT HS0 00	Installation Tool Vantage Herramienta Instalación Vantage Clef Special de Montage Vantage	1
UEV ANT KR0 01	Vantage Rotating Nozzle Complete Kit Vantage Kit Boquilla Rotativa Completa Vantage Kit Buse Rotatif Complete	3
UEV ANT KF0 01	Vantage Fixed Nozzle Complete Kit Vantage Kit Boquilla Fija Completa Vantage Kit Buse Fixe Complete	1
UEM DX0 DS0 00	MDX - Security Screwdriver MDX - Destornillador Seguridad MDX - Tournevis de Sécurité	1
UEM DX0 TP0 00	MDX - Construction Cover for Fiberglass MDX - Tapa de construcción piscinas fibra MDX - Couverture de Construction pour fibre de verre	1
UEC RT6 300 01	Debris Canister - Deck Lid & Ring Cesta de Recogida - Tapa registro con marco Piege a Feuilles - Couverture avec cadre et anneau	1

8 colors available
8 colores disponibles
8 couleurs disponibles



VANTAGE COMPLETE SYSTEM

*Vantage System for One Piece Pools it is study and designed with the Pool Manufacturer. Its basic components are:

- 1 Paramount Water Valve 6 ports
- 3 Rotating Nozzles
- 1 Fixed Nozzle
- 1 Active Main Drain-MDX for fiber
- 1 Debris Canister w/cover
- 1 Installation Tool

SISTEMA COMPLETO VANTAGE

*El Sistema de Limpieza Vantage para piscinas prefabricadas se estudia especialmente con el fabricante de las piscinas y se compone basicamente de:

- 1 Válvula Distribuidora - 6 puertos
- 3 Boquillas Rotativas
- 1 Boquilla Fija
- 1 Sumidero Activo MDX - Fibra
- 1 Cesta de Recogida con cubierta
- 1 Herramienta de Instalación

SYSTEME COMPLET VANTAGE

*Le systeme de nettoyage integre Vantage est specialement etudie pour les piscines fibre de verre. Il se compose de:

- 1 Vanne de Commande Paramount—6 sorties
- 3 Buses Rotatives
- 1 Buse Fixe
- 1 Bonde de Fond Active- MDX- Fibre de verre
- 1 Piege a Feuilles "ADR" avec couverture
- 1 Clef Spéciale de Montage

1 Vantage Complete System
1 Sistema Completo Vantage
1 Système Complete Vantage

PARAMOUNT POOLS - WATER VALVES
VÁLVULAS DISTRIBUIDORAS - PARAMOUNT POOLS
VANNES DE COMMANDE - PARAMOUNT POOLS

Code Código Code	Product Description Descripción Producto Désignation des Articles	Case Qty. Unid. Caja Unit. Boîte
------------------------	---	--

	WATER VALVES VÁLVULAS DISTRIBUIDORAS VANNES DE COMMANDE	
UEV D06 100 01	Water Valve 6 ports - 63 mm Válvula Distribuidora 6 salidas - 63 mm Vanne de Commande 6 sorties - 63 mm	1
UEV D09 100 02	Water Valve 9 ports - 63 mm Válvula Distribuidora 9 salidas - 63 mm Vanne de Commande 9 sorties - 63 mm	1
UEV D12 100 04	Water Valve 12 ports - 63 mm Válvula Distribuidora 12 salidas - 63 mm Vanne de Commande 12 sorties - 63 mm	1
UEM V06 100 01	Inside Module for Water Valve 6 ports Módulo Interior Válvula Distribuidora 6 salidas Module Vanne de Commande 6 sorties	1
UEM V02 100 03	Inside Module for Water Valve 2 ports Módulo Interior Válvula Distribuidora 2 salidas Module Vanne de Commande 2 sorties	1
UEM V03 100 06	Inside Module for Water Valve 3 ports Módulo Interior Válvula Distribuidora 3 salidas Module Vanne de Commande 3 sorties	1
UET V06 CP0 01	Top Valve Complete Tapa completa Válvula Couverture Complète Vanne	1
UEB V06 100 01	Valve Base 6 ports - 63 mm Base Válvula 6 salidas - 63 mm Base Vanne 6 sorties - 63 mm	1
UEJ GV0 610 01	Valve O-Ring Junta Válvula Distribuidora Anneau pour Vanne	1
UEC CV0 T00 01	Clamp Band for Water Valve Abrazadera Cierre Válvula Collier De Serrage pour Vanne	1
UET ISV 000 01	Winterizing Plug for Water Valve port Tapón Invernar salida Válvula Distribuidora Bouchon d'Hiver pour la Sortie de la Vanne	6

** Hydraulic Water Valves with proved efficiency, reliability and durability in many installations in all conditions, from many years, all over the world. The unique completely hydraulic (not electric) distributor water valves with 9 and 12 ports. * Hydraulic Water Valves with proved efficiency, reliability and durability in many installations in all conditions, from many years, all over the world. The unique completely hydraulic (not electric) distributor water valves with 9 and 12 ports. * Válvulas Distribuidoras hidráulicas con una eficiencia, fiabilidad y durabilidad probadas en muchas instalaciones, en diversas condiciones, durante muchos años en todo el mundo. Las únicas Válvulas Distribuidoras de 9 y 12 salidas, completamente hidráulicas (no eléctricas). * Vannes de Commande hydrauliques avec une efficience, une fiabilité et une durabilité prouvées dans beaucoup d'installations, dans diverses conditions, pendant de nombreuses années dans le monde. Les seules Vannes de Commande de 9 et*



Water Valve 6 ports - 63 mm
Válvula Distribuidora 6 salidas - 63 mm
Vanne de Commande 6 sorties - 63 mm



Inside Module for Water Valve 6 ports
Módulo Interior Válvula Distribuidora 6 salidas
Module Vanne de Commande 6 sorties

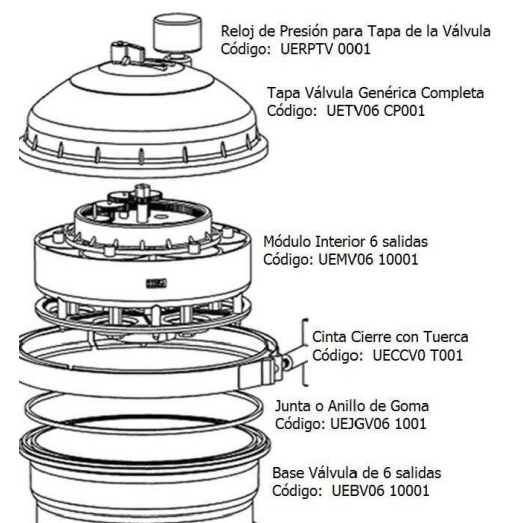

MDX - ACTIVE MAIN DRAIN
MDX - SUMIDERO ACTIVO
MDX - BONDE DE FOND ACTIVE



Code Código Code	Product Description Descripción Producto Désignation des Articles	Case Qty. Unid. Caja Unit. Boîte
------------------------	---	--

	MDX - ACTIVE MAIN DRAIN MDX - SUMIDERO ACTIVO MDX - BONDE DE FOND ACTIVE	
UEM DX3 H75 01	MDXR3 - Main Drain Active for Concrete Pools MDXR3 - Sumidero Activo para piscinas de hormigón MDXR3 - Bonde de Fond Active pour piscines de béton	1
EUM DX3 L75 01	MDXR3 - Main Drain Active for Liner Pools MDXR3 - Sumidero Activo para piscinas Liner MDXR3 - Bonde de Fond Active pour piscines Liner	1
EUM DX3 P75 01	MDXR3 - Main Drain Active for One Piece Pools MDXR3 - Sumidero Activo para piscinas de poliester MDXR3 - Bonde de Fond Active pour piscines de Poliester	1
UEM DX2 H75 01	MDX2 - Main Drain Active for Concrete Pools MDX2 - Sumidero Activo para piscinas de hormigón MDX2 - Bonde de Fond Active pour piscines de béton	1
EUM DX2 L75 01	MDX2 - Main Drain Active for Liner Pools MDX2 - Sumidero Activo para piscinas Liner MDX2 - Bonde de Fond Active pour piscines Liner	1
EUM DX2 P75 01	MDX2 - Main Drain Active for One Piece Pools MDX2 - Sumidero Activo para piscinas de poliester MDX2 - Bonde de Fond Active pour piscines de Poliester	1
005 202 2206 XX	MDX - Main Drain Active for Concrete Pools MDX - Sumidero Activo para piscinas de hormigón MDX - Bonde de Fond Active pour piscines de béton	1
004 212 2206 XX	MDX - Main Drain Active for Liner Pools MDX - Sumidero Activo para piscinas Liner MDX - Bonde de Fond Active pour piscines Liner	1
UES DXP H00 01	SDX - High Flow Suction Device SDX - Toma Aspiración Alto Caudal SDX - Prise Aspiration Haut Débit	1

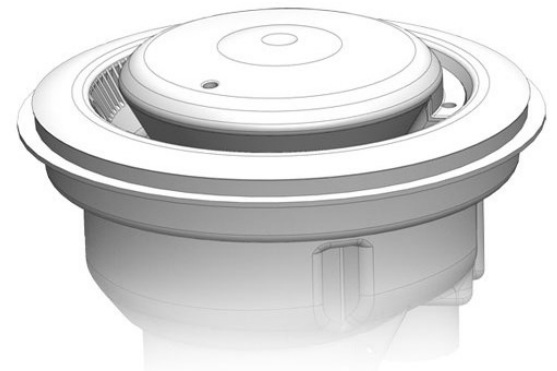

MDX R3



MDX²



SDX



HIGH FLOW SAFETY DRAIN

** MDX is the most secure and the unique active drain in the world. Made specially for Swimming Pools with or without an In-Floor Cleaning System installed, can take out from the pool big quantities of debris without creating any restriction. In combination with the SDX it is the most secure Main Drain in the market today.*

** MDX es el más seguro y el único Sumidero Activo en el mundo. Hecho especialmente para Piscinas que tengan o no un Sistema Integrado de Limpieza instalado, puede remo-ver grandes cantidades de residuos de dentro de la piscina sin crear ninguna restricción. Combinado con el SDX es el Sumidero más seguro del mercado hoy en día.*

** MDX est le seul Drain Actif dans le monde. Fabriqué spécialement pour des Piscines avec ou sans un Système Intégré de Propreté installé, il peut décaler de grandes quantités de résidus de dans la piscine sans créer aucune restriction. En combinaison avec le SDX, c'est le Drain qui fournit davantage de sécurité de nos jours.*

8 colors available
 8 colores disponibles
 8 couleurs disponibles

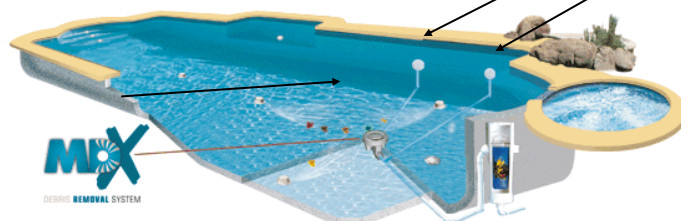

DESIGN REMOVAL SYSTEM

ADR - AUTOMATIC DEBRIS REMOVAL
ADR - RECOGIDA AUTOMÁTICA DE RESIDUOS
ADR - PIÈGE À FEUILLES AUTOMATIQUE

Code Código Code	Product Description Descripción Producto Désignation des Articles	Case Qty. Unid. Caja Unit. Boîte
------------------------	---	--

	ADR - AUTOMATIC DEBRIS REMOVAL ADR - RECOGIDA AUTOMÁTICA DE RESIDUOS ADR - PIÈGE À FEUILLES AUTOMATIQUE	
UEC RM6 300 01	Debris Canister - Metric Cesta de Recogida - Métrica Piège à Feuille - Métrique	1
UEC RT6 300 01	Deck Lid & Ring for Canister Tapa de Registro con Aro empotrar para la Cesta Couverture avec cadre et anneau pour le Piège a Feuilles	1
UEC RBI 000 00	Bag for Canister Mesh Bolsa Interior Cesta de Recogida Sac pour Piège à feuilles	1
UEC RCI A00 00	Basket Canister Stainless Steel Canasta Interior Metálica - Cesta de Recogida Panier intérieur métallique pour Piège à Feuille	1
PS1 FGI 1001 00	Pressured Debris Canister - Metric Cesta de Recogida Presiurizada - Métrica Piège à Feuille sous Pression - Métrique	1
STO RC1 10CR 75	Kit Connection Pressured Debris Canister - Metric Kit Conexion Cesta de Recogida Presiurizada - Métrica Kit Connexion Piège à Feuille sous Pression - Métrique	1



**DEBRIS CANISTER
CESTA DE RECOGIDA
PIÈGE À FEUILLE**



**PRESSURED DEBRIS CANISTER
CESTA DE RECOGIDA PRESIÓN
PIÈGE À FEUILLE SOUS PRESSION**

** Manufactured to house extra large amount of debris, the Canister is more than recommended to be installed in all the swimming pools which are closer of trees, plants or any other debris sources. The special design provides a high dirt holding capacity thus decreasing its cleaning frequency.*

** Construida para recoger una gran cantidad de residuos, la Cesta es más que recomendada para ser instalada en piscinas que tienen cerca fuentes de suciedad como árboles o plantas. Su diseño especial le confiere una gran capacidad de almacenamiento que significa una frecuencia de limpieza muy reducida.*

** Construite pour recueillir une grande quantité de résidus, le Piège à Feuille, est recommandé qu'il soit installé dans des piscines qui ont près des sources de saleté comme arbres ou plantes. Sa conception spéciale lui confère une grande capacité de stockage qui signifie une fréquence de propreté très réduite.*

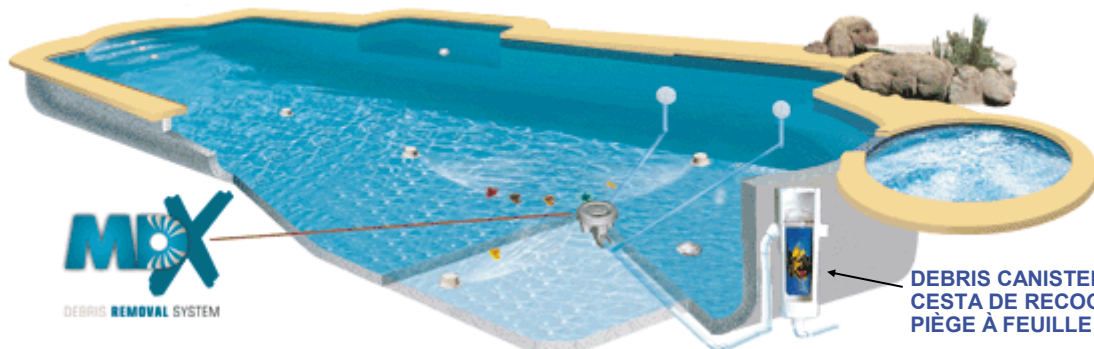

**DEBRIS CANISTER
CESTA DE RECOGIDA
PIÈGE À FEUILLE**

Code Código Code	Product Description Descripción Producto Désignation des Articles	Case Qty. Unid. Caja Unit. Boîte
------------------------	---	--

	POOL VALET RETRO POOL VALET RETRO POOL VALET RETRO	
UEP VKR 000 01	POOL VALET RETRO KIT - WHITE KIT POOL VALET RETRO - BLANCO KIT POOL VALET RETRO - BLANC	1
UEP VKR 000 02	POOL VALET RETRO KIT - DARK GREY KIT POOL VALET RETRO - GRIS OSCURO KIT POOL VALET RETRO - GRIS FONCÉ	1
UEP VKR 000 03	POOL VALET RETRO KIT - BLACK KIT POOL VALET RETRO - NEGRO KIT POOL VALET RETRO - NOIR	1
UEP VKR 000 04	POOL VALET RETRO KIT - TAUPE KIT POOL VALET RETRO - MARRON OSCURO KIT POOL VALET RETRO - TAUPE	1
UEP VKR 000 05	POOL VALET RETRO KIT - DARK BLUE KIT POOL VALET RETRO - AZUL OSCURO KIT POOL VALET RETRO - BLEU FONCÉ	1
UEP VKR 000 06	POOL VALET RETRO KIT - LIGHT BLUE KIT POOL VALET RETRO - AZUL CLARO KIT POOL VALET RETRO - BLEU CLAIRE	1
UEP VKR 000 07	POOL VALET RETRO KIT - BEIGE KIT POOL VALET RETRO - MARRON CLARO KIT POOL VALET RETRO - BEIGE	1
UEP VKR 000 08	POOL VALET RETRO KIT - LIGHT GREY KIT POOL VALET RETRO - GRIS CLARO KIT POOL VALET RETRO - GRIS CLAIRE	1
UEP VRH 000 01	INSTALLATION TOOL POOL VALET RETRO HERRAMIENTA INSTALACIÓN POOL VALET RETRO CLEF DE MONTAGE POOL VALET RETRO	1

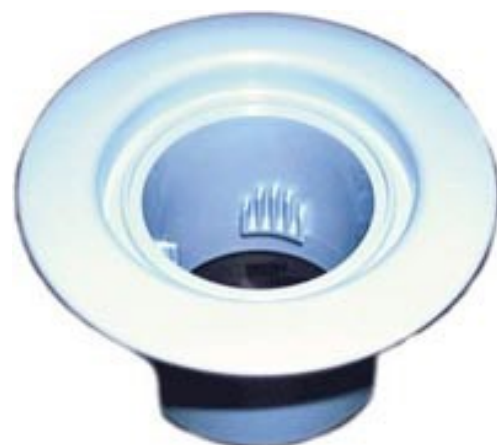

* Specially designed for Swimming Pools with a Pool Valet System installed, this nozzle can be glued in minutes inside the old Pool Valet body, increasing in this way the cleaning radius up to 2 m. Manufactured in 8 different colors, It also can adapt the entire System to the color of the pool.

* Especialmente diseñado para piscinas que tengan un Sistema Pool Valet instalado, esta boquilla se puede instalar en pocos minutos, dentro del cuerpo de la boquilla Pool Valet antigua, incrementando de este modo el radio de limpieza en hasta 2 metros. Fabricada en 8 colores diferentes, se puede adaptar perfectamente al color del acabado de la piscina.

* Spécialement conçu pour des piscines qui ont un Système Pool Valet installé, cette buse peut être installée dans quelques minutes, dans le corps de les buses de Pool Valet, en augmentant de cette manière le rayon de nettoyage dans jusqu'à 2 mètres. Fabriquée dans 8 couleurs différentes, il peut parfaitement s'adapter à la couleur de la piscine.

8 colors available
 8 colores disponibles
 8 couleurs disponibles

INSTALLATION TOOL POOL VALET RETRO
 HERRAMIENTA INSTALACIÓN POOL VALET RETRO
 CLEF DE MONTAGE POOL VALET RETRO

RETRO JET NOZZLE
IMPULSOR RETRO JET
BUSE RETRO JET



Code Código Code	Product Description Descripción Producto Désignation des Articles	Case Qty. Unid. Caja Unit. Boîte
	RETRO JET NOZZLE IMPULSOR RETRO JET BUSE RETRO JET	
UER IQ2 001 00	RETRO JET - QUICKCLEAN2 - WHITE RETRO JET - QUICKCLEAN2 - BLANCO RETRO JET - QUICKCLEAN2 - BLANC	1
UER IQ2 003 00	RETRO JET - QUICKCLEAN2 - BLACK RETRO JET - QUICKCLEAN2 - NEGRO RETRO JET - QUICKCLEAN2 - NOIR	1
UER IQ2 007 00	RETRO JET - QUICKCLEAN2 - BEIGE RETRO JET - QUICKCLEAN2 - BEIGE RETRO JET - QUICKCLEAN2 - BEIGE	1
UER IQ2 009 00	RETRO JET - QUICKCLEAN2 - CREAM RETRO JET - QUICKCLEAN2 - CREMA RETRO JET - QUICKCLEAN2 - CREME	1
UER IQ2 010 00	RETRO JET - QUICKCLEAN2 - GREY RETRO JET - QUICKCLEAN2 - GRIS RETRO JET - QUICKCLEAN2 - GRIS	1
UER IC9 901 00	RETRO JET - CARETAKER99 - WHITE RETRO JET - CARETAKER99 - BLANCO RETRO JET - CARETAKER99 - BLANC	1
UER IC9 903 00	RETRO JET - CARETAKER99 - BLACK RETRO JET - CARETAKER99 - NEGRO RETRO JET - CARETAKER99 - NOIR	1
UER IC9 904 00	RETRO JET - CARETAKER99 - TAUPE RETRO JET - CARETAKER99 - TAUPE RETRO JET - CARETAKER99 - TAUPE	1
UER IC9 908 00	RETRO JET - CARETAKER99 - LIGHT GREY RETRO JET - CARETAKER99 - GRIS CLARO RETRO JET - CARETAKER99 - GRIS CLAIRE	1
UER IC9 909 00	RETRO JET - CARETAKER99 - CREAM RETRO JET - CARETAKER99 - CREMA RETRO JET - CARETAKER99 - CREME	1
UER IC9 911 00	RETRO JET - CARETAKER99 - BLUE WATER RETRO JET - CARETAKER99 - AZUL AGUA RETRO JET - CARETAKER99 - BLEU L'EAU	1
UER IH0 000 00	INSTALLATION TOOL - RETRO HERRAMIENTA INSTALACIÓN - RETRO OUTIL INSTALATIÓN - RETRO	1



INSTALLATION TOOL
HERRAMIENTA INSTALACIÓN
OUTIL INSTALLATION

** Reliable Nozzles designed to replace defective nozzles of different manufacturers.*
** Impulsores de una fiabilidad excepcional, diseñados para reemplazar los impulsores originales de otros fabricantes.*
** Jets d'une fiabilité exceptionnelle, conçus pour remplacer les jets originaux d'autres fabricants.*



SMART UNDERWATER LIGHTS
FOCOS SUBACUÁTICOS SMART
LUMIERES SOUS-MARINES SMART

SmartAquaLight

Code Código Code	Product Description Descripción Producto Désignation des Articles	Case Qty. Unid. Caja
	Underwater automatic color changing light Luz Subacuatica con cambio automatico de colores Systeme d'eclairage sous l'eau a ch. aut. de couleur	
CDN AQU 0001 RR	Smart Aqua Light Complete with Housing—8 programs Smart Aqua Light Foco Completo con nicho —8 programas Smart Aqua Light avec Niche—8 programme	1
BEL 252 5619 FP	Smart Flat Light Complete - 252 LED - 19 programs Smart Foco Plano Completo - 252 LED - 19 programas Smart Lumière Plat Complet - 252 LED - 19 programme	1
BEL 252 56WH FP	Smart Flat Light Complete - 252 LED White Light Smart Foco Plano Completo - 252 LED Luz Blanca Smart Lumière Plat Complet - 252 LED Lumière Blanche	1
BEL 252 5616 PB	Smart Aqua Light PAR56 252 LED 16 Programs Smart Aqua Light PAR56 252 LED 16 Programas Smart Aqua Light PAR56 252 LED 16 Programmes	6
BEL 252 5619 PB	Smart Aqua Light PAR56 252 LED 19 Programs Smart Aqua Light PAR56 252 LED 19 Programas Smart Aqua Light PAR56 252 LED 19 Programmes	6
BEL 252 56WH BB	Smart Aqua Light PAR56 252 LED White Light Smart Aqua Light PAR56 252 LED Luz Blanca Smart Aqua Light PAR56 252 LED Lumière Blanche	6
BEL PLR EM10 00	Remote Controller With 220 V to 12 V AC transformer Mando a Distancia con transformador 220 v a 12 V AC Contrôleur à distance avec transformateur 220 V-12 V AC	1
BEL PLR EMST 00	Remote Controller Without Transformer Mando a Distancia sin transformador Contrôleur à distance sans transformateur	1

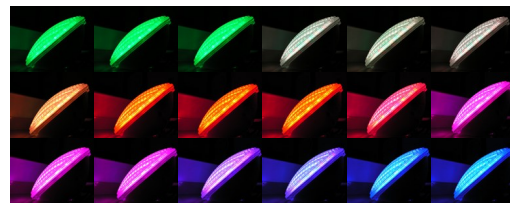

Smart PAR 56 LED Bulb
 Smart PAR56 Bombilla LED
 Smart PAR56 Ampoule LED



Smart Flat Light Complete
 Smart Foco Plano Completo
 Smart Lumière Plat Complet

** New LED Digital Technology-10 Times Longer life than regular bulbs. Eight to Nineteen Color Combinations at the flip of the switch. * Low Voltage -Low Power Lighting System 15 to 35 watt .*

** Nueva tecnología digital LED – Una vida útil 10 veces mayor que las bombillas convencionales. Ocho a 19 combinaciones de colores con accionar un botón. Sistema de Iluminación de Bajo Voltaje- Consumo Reducido 15 a 35 vatios.*

** Nouvelle technologie digital– durée de vie 10 fois supérieure a celle des ampoules ordinaires. * Huit à dix-neuf combinaisons de couleurs au simple toucher de l'interrupteur. * Système d'illumination de Bas Voltage- Consommation Réduite 15 a 35 watts.*

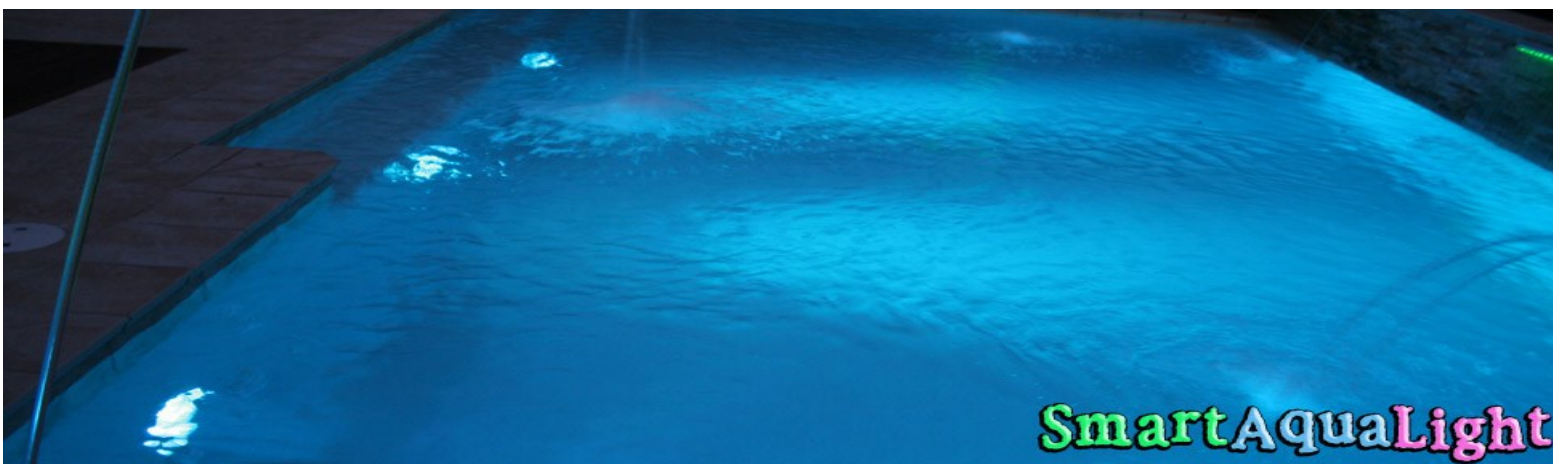

SmartAquaLight

**SMART FILTERS
FILTROS SMART
FILTRES SMART**

Smart Filters

Code Código Code	Product Description Descripción Producto Désignation des Articles	Case Qty. Unid. Caja Unit. Boîte
------------------------	---	--

	Smart Pools Filter Smart Pools Filtro Smart Pools Filtre	
WAT 021 6540 MA	Smart Pools Ecological Filter Smart Pools Filtro Ecológico Smart Pools Filtre Écologique	1

* Built to house extra large filter cartridges with surface areas of up to 37 m², max. pressure working up to 3,5 bar. The design provides a high dirt holding capacity thus decreasing its cleaning frequency. Considered Ecological because of the water savings compared with the sand filters.

* Construido con una superficie filtrante de 37 m² y resistente a una presión máxima de 3,5 bar. Su diseño le confiere una gran capacidad de filtrado que significa una frecuencia de limpieza muy reducida. Considerado Ecológico por su ahorro importante de agua.

* Construit avec une superficie filtrante de 37 m² et résistant a une pression maxime de 3,5 bar. Conçu spécialement avec une grande capacité filtrante qui signifie une fréquence de nettoyage très réduit. Considéré Ecologique par les économies important d'eau.

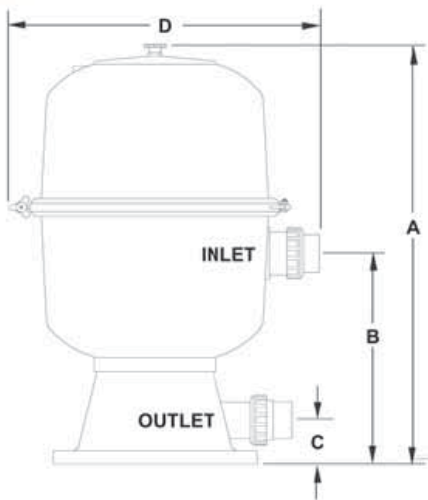

A	B	C	D
1250mm	615mm	95mm	500mm

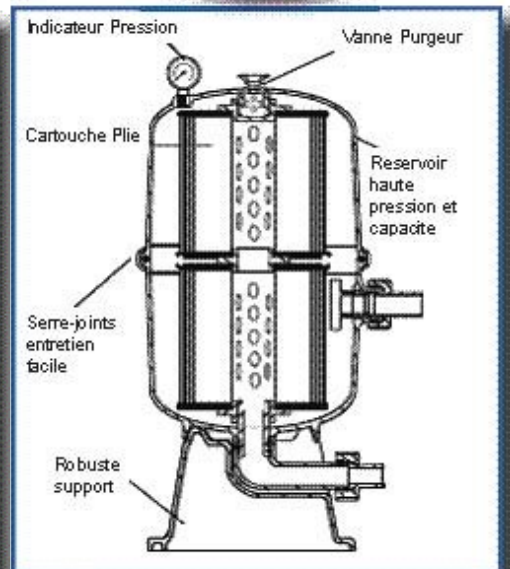
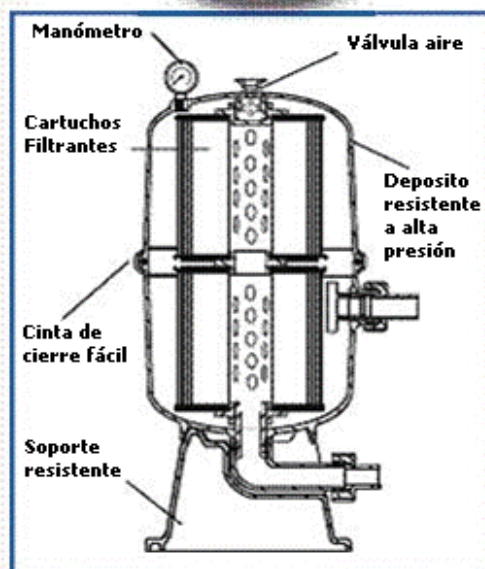
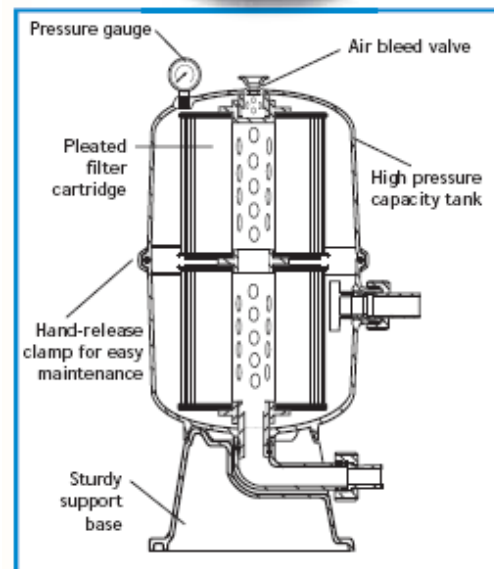

Code Código Code	Product Description Descripción Producto Désignation des Articles	Case Qty. Unid. Caja Unit. Boîte
------------------------	---	--

	Smart Pools Pre-Filter Smart Pools Pre-Filtro Smart Pools Pre-Filtre	
WAT 020 0375 MA	Smart Cyclone Pre-Filter Smart Cyclone Pre-Filtro Smart Cyclone Pre-Filtre	1

** Smart Cyclone works with a centrifugal filtration of the water. It does not have any component that with the water movement are worn away as well as it is not necessary to clean or to replace the filtrate system (cartridge, sand, etc.). Smart Cyclone is ideal as pre-filter that helps to prolong the life of its present filter. Its method of operation can eliminate until a 80% of the dirt that is deposited in the swimming pool. Recommended to be installed as pre-filter for the water valves of the automatic cleaning systems, as well as for waterfalls or water games that require filtered water.*

** Smart Cyclone funciona a base de una filtración centrífuga del agua. No posee componentes que con el movimiento se desgasten así como tampoco es necesario limpiar o sustituir el sistema de filtrado (cartucho, arena, etc.). Smart Cyclone es ideal como prefiltro que ayuda a prolongar la vida de su filtro actual. Su método de funcionamiento conseguirá que elimine hasta un 80% de la suciedad que se deposita en su piscina. Ideal para ser instalado como pre-filtro para las válvulas de los sistemas de limpieza automática, así como para cascadas o juegos de agua que requieren agua filtrada.*

** Smart Cyclone fonctionne sur base d'une filtration centrifuge de l'eau. Il ne possède pas de composants qu'avec le mouvement ils sont usés et non plus il est nécessaire de nettoyer ou de remplacer le système de filtrat (cartouche, sable, etc.). Smart Cyclone est idéal comme pre-filtre qui aide à prolonger la vie de son filtre actuel. Sa méthode de fonctionnement obtiendra qu'elle élimine jusqu'à 80% de la saleté qui se dépose dans sa piscine. Idéal pour être installé comme pre-filtre pour les valves des systèmes de nettoyage*



**SMART PUMPS
BOMBAS SMART
POMPES SMART**

Code Código Code	Product Description Descripción Producto Désignation des Articles	Case Qty. Unid. Caja Unit. Boîte
------------------------	---	--

	Smart Pumps Smart Bombas Smart Pompes	
WA2 405 075E UM	Smart HydroStorm Plus 75	1
WA2 405 100E UM	Smart HydroStorm Plus 100	1
WA2 405 150E UM	Smart HydroStorm Plus 150	1
WA2 405 200E UM	Smart HydroStorm Plus 200	1
WA2 405 250E UM	Smart HydroStorm Plus 250	1



*Large 2.25 liter hair & lint basket-reduces maintenance. Quarter lid and lock ring assembly easy access to strainer basket.316 stainless steel hardware-improved corrosion resistance.

*Con una cesta de más de 2,25 litros de capacidad - se reduce el mantenimiento. Una tapa transparente con un simple aro, facilitan el acceso a la cesta. El acero de alta resistencia empleado para la fabricación de las bombas aumenta su resistencia.

* Vaste panier de 2.25 litres pour cheveux et fibres- entretien réduit. Couvercle et ser-ure d'anneau assemblée diviser par quartier- accès facile au panier passoire. 316 acier inoxydable hardware résistance du corrosion supérieure.

SMART PUMPS AVAILABLE MODELS

MODELOS DISPONIBLES BOMBAS SMART

MODELES DISPONIBLES POMPES SMART

Pump	HP	kW	Amps/ Phase	Phase	Total Length	Motor Frame
100	1.00	0.91	4.0	1	676	71
125	1.25	1.08	4.8	1	676	80
150	1.50	1.31	6.0	1	676	80
200	2.00	1.46	6.6	1	676	80
250	2.50	1.92	8.9	1	697	80
300	3.00	2.37	11.0	1	719	90
350	3.50	2.57	12.1	1	719	90

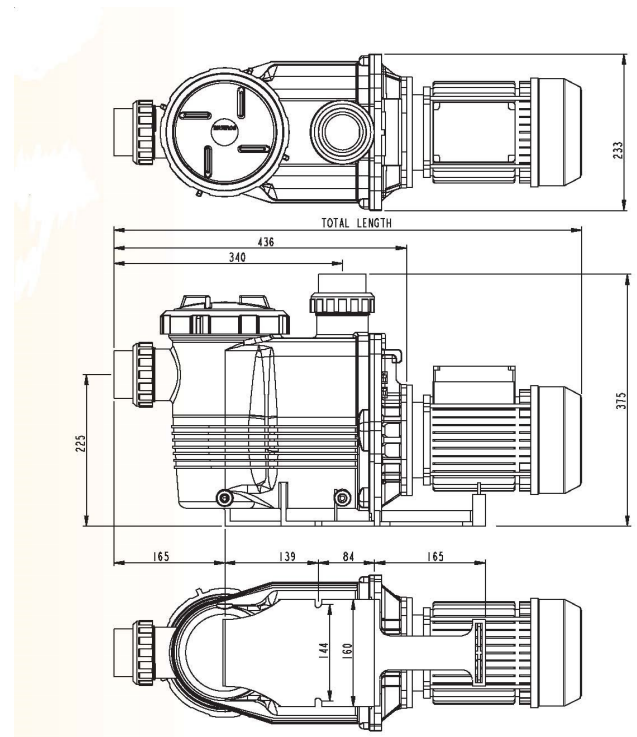

SMART PUMP PERFORMANCE CHART

CURVAS DE RENDIMIENTO BOMBAS SMART

TABLEAU DE PERFORMANCE SMART POMPE

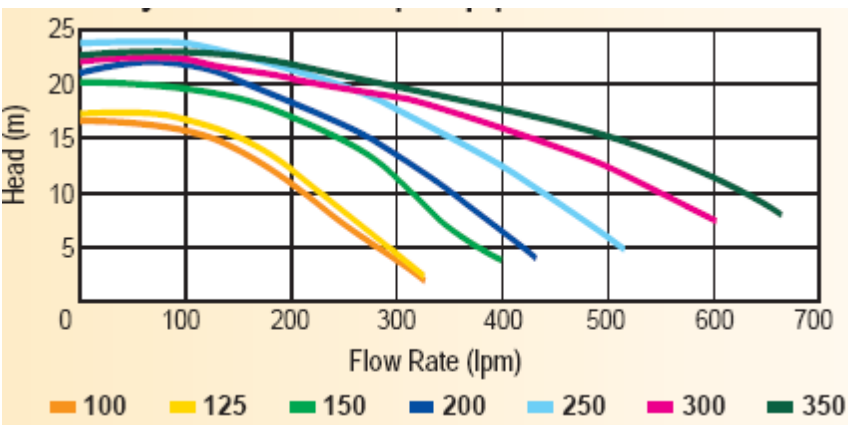

SMART SKIMMERS
SKIMMERS SMART
SKIMMERS SMART

Code Código Code	Product Description Descripción Producto Désignation des Articles	Case Qty. Unid. Caja Unit. Boîte
------------------------	---	--

	Smart Skimmers Skimmers Smart Skimmers Smart	
WAT 002 9201 MA	Smart Pool Skimmers Smart Pool Skimmers Smart Pool Skimmers	1

**Large capacity skimmer box which is deal for use in large domestic, semi commercial, and commercial swimming pools. Because of its large capacity 5.9 litre debris collection it is also ideal for any swimming pool that is constructed in leafy environments.*

**Skimmer de alta capacidad recomendable para grandes piscinas domesticas, publicas o piscinas comerciales. La gran capacidad de su cesta de 5,9 litros hacen que sea recomendable en especial en aquellas zonas donde abundan las hojas de plantas.*

** Boite skimmer avec une capacité grande, idéal pour l'utiliser aux piscines vastes, domestiques, moitié commercial, et commercial. Du au fait que la capacité est de 5.9 litres collection de débris, le skimmer est idéal pour quelqu'une piscine qui est construit dans une environnement au feuillage abondant.*



Max Surface Area	Suction Pipe mm	Side Port mm	Opening mm	Basket Capacity liters	Overall Height mm	Overall Depth mm	Unit Weight kg
Superficie Máxima	Tubería Aspiración mm	Salida Lateral mm	Apertura mm	Capacidad Del cesto litros	Altura Total mm	Profundidad Total mm	Peso Unidad kg
Max Aire Superficie	Tuyau Succión mm	Sortie Lateral mm	Ouverture mm	Panier Capacité litres	Hauteur General mm	Profondeur General mm	Poids Unite kg
75m ²	2 x 63	2 x 40	247x152	5.9	580	500	5.6

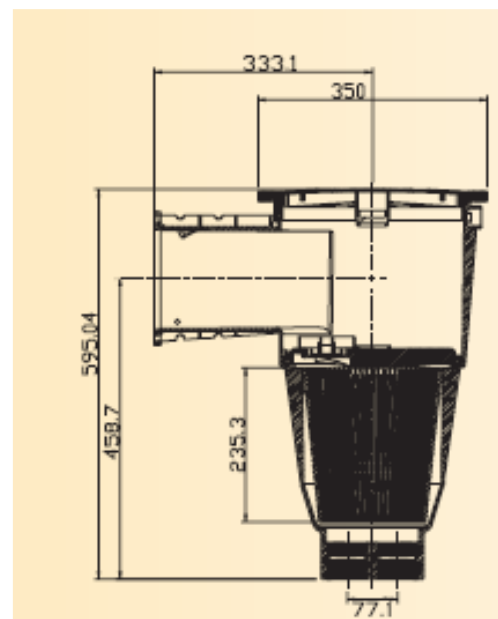
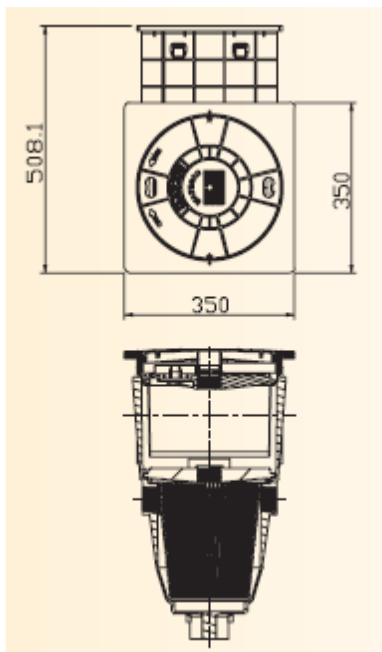

SMART VALVES
VÁLVULAS SMART
VANNES SMART

Code Código Code	Product Description Descripción Producto Désignation des Articles	Case Qty. Unid. Caja Unit. Boîte
------------------------	---	--

	Smart Valves Válvulas Smart Vannes Smart	
WAT 001 4653 MA	Check Valve 63/75mm 180° - clear top Valvula anti-retorno 63/75mm 180° - visor Valve anti-retour 63/75mm 180° - viseur	12
WAT 001 4650 EU	Check Valve 63mm Valvula anti-retorno 63mm Valve anti-retour 63mm	12
WAT 014 8563 MA	Valve 2 ways - teflon Válvula 2 vías 63/75mm con teflón Valve 2 voies 63/75mm avec teflón	12
WAT 014 8603 MA	Valve 3 ways - teflon Válvula 3 vías 63/75mm con teflón Valve 3 voies 63/75mm avec teflón	12



**Teflon Valves in 63 / 75 mm ports with 2 or 3 ways, ideal for motorize.*
**Válvulas impregnadas con teflón, en 63 / 75 mm, con 2 o 3 vías, ideales para automatizarlas.*
**Valves imprégnées avec téflon, dans 63 / 75 mm, avec 2 ou 3 voies, idéals pour les automatiser.*



SMART WATERFALLS
CASCADAS SMART
CASCADES SMART

Code Código Code	Product Description Descripción Producto Désignation des Articles	Case Qty. Unid. Caja Unit. Boîte
	Smart Waterfalls Cascadas Smart Cascades Smart	
OJ4 001 001W BF	Smart Waterfall Sheer descent - 30,48 cm Smart Cascada Lámina de agua - 30, 48 cm Smart Cascade lame déau- 30,48 cm	1
OJ4 001 004W BF	Smart Waterfall Sheer descent - 121,92 cm Smart Cascada Lámina de agua - 121,92 cm Smart Cascade lame déau- 121,92 cm	1
OJ4 011 070W 03	Smart Waterfall Sheer descent - 213,36 cm Smart Cascada Lámina de agua - 213,36 cm Smart Cascade lame déau- 213,36 cm	1
OJ4 011 080W 03	Smart Waterfall Sheer descent - 243,84 cm Smart Cascada Lámina de agua - 243,84 cm Smart Cascade lame déau- 243,84 cm	1
OJ4 012 010J SR	Smart Waterfall Rain descent - 30,48 cm Smart Cascada Lluvia - 30, 48 cm Smart Cascade pluie- 30,48 cm	1
OJ4 012 030W 03	Smart Waterfall Rain descent - 91,44 cm Smart Cascada Lluvia - 91,44 cm Smart Cascade pluie- 91,44 cm	1
OJ4 012 040J SR	Smart Waterfall Rain descent - 121,92 cm Smart Cascada Lluvia - 121,92 cm Smart Cascade pluie- 121,92 cm	1
OJ4 012 070J SR	Smart Waterfall Rain descent - 213,36 cm Smart Cascada Lluvia - 213,36 cm Smart Cascade pluie- 213,36 cm	1
OJ4 019 040J 03	Smart Garden Box Waterfall Smart Cascada Jardinera Smart Cascade Boîte de Jardin	1
FBC LSL L000 OH	Smart Deck Laminar LED programmable light Smart Jet Laminar LED Luz programmable Smart Jet Laminaire LED Lumière Programmable	1
FBC LSD ML00 OH	Smart Deck Laminar Mini LED programmable light Smart Jet Laminar Mini LED Luz Programmable Smart Jet Laminaire Mini LED Lumière Programmable	1
FBC LSR W488 OH	Smart Waterfall Rain 1,21 m LED Programmable light Smart Cascada Lluvia 1,21 m LED Luz Programable Smart Cascade pluie 1,21 m LED Lumière Programmable	1
FB2 CLS LBK0 OH	Smart Bubbler LED Programmable Light Smart Generador Burbujas LED Luz Programable Smart Barboteur LED Lumière Programmable	1

**All Smart Waterfalls come with metric adaptors. An easy installation to create great effects. The LED lighted products are composed by 4 basic colors which can automatically change, or can be stopped in the desired color. All LED products synchronized between.*

**Todas las cascadas Smart se entregan con adaptadores métricos. Una instalación sencilla para crear sorprendentes efectos. Los productos que se iluminan con LED tienen 4 colores básicos que cambian de forma automática o pueden iluminar en un color fijo. Los productos se sincronizan entre ellos.*

**Toutes les cascades Smart sont livrées avec des adaptateurs métriques. Installation facile pour créer des effets surprenants. Les produits allumés par LED se composent par 4 couleurs de base qui peuvent automatiquement changer, ou peuvent être arrêtés dans la couleur désirée. Tous les produits de LED synchronisés.*



PARAMOUNT - CLEAR O³ - OZONE GENERATOR
 PARAMOUNT - CLEAR O³ - GENERADOR DE OZONO
 PARAMOUNT - CLEAR O³ - GÉNÉRATEUR DE L'OZONE



Code Código Code	Product Description Descripción Producto Désignation des Articles	Case Qty. Unid. Caja Unit. Boîte
------------------------	---	--

	OZONE GENERATOR GENERADOR DE OZONO GÉNÉRATEUR DE L'OZONE	
UEC 03G 030 00	CLEAR O3 - Ozone Generator CLEAR O3 - Generador de Ozono CLEAR O3 - Générateur de l'Ozone	1
UEC 03G 030 20	CLEAR O3 - Ozone Generator Double Unit CLEAR O3 - Generador de Ozono Unidad Doble CLEAR O3 - Générateur de l'Ozone Unité Double	1

* The Clear O3 unit complements the water treatment equipment and it works together with chlorine, bromine or active oxygen, reducing their consumption up to 70%, oxidizing most of the organic debris that the pool water contains. Destroys algae, bacteria, mold, viruses, prolongs equipment life. The single unit works for pools up to 200 m3, and the double unit works for pools up to 400 m3.

* El Clear O3 complementa el equipamiento de tratamiento de agua, trabajando en conjunto con el cloro, bromo u oxígeno activo, reduciendo su consumo en hasta un 70%, oxidiando la mayoría de los contaminantes orgánicos. Destruye algas, bacterias, virus y pro-longa la vida útil del equipamiento de la piscina. La unidad básica se instala in piscinas de hasta 200 m3, mientras la unidad doble, trabaja para piscinas de hasta 400 m3.

* Le Clear O3 complète l'équipement de traitement d'eau, travaillant dans l'ensemble avec le chlore, brome ou oxygène actif, en réduisant sa consommation dans jusqu'à 70%, en oxydant la majorité des polluants organiques. Il détruit des algues, des bactéries, virus et prolonge la vie utile de l'équipement de la piscine. L'unité de base est installée in piscines de jusqu'à 200 m3, tandis que l'unité double, travaille pour des piscines de jusqu'à 400 m3.



HIDROZONE - ECOLOGICAL WATER TREATMENT
HIDROZONE - TRATAMIENTO ECOLÓGICO DE AGUA
HIDROZONE - TRAITEMENT ÉCOLOGIQUE DE L'EAU

Ecological Water Treatment

Hidrozone

Code Código Code	Product Description Descripción Producto Désignation des Articles	Case Qty. Unid. Caja Unit. Boîte
------------------------	---	--

	Hydrolysis with OZONE Hidrólisis con OZONO Hydrolyse avec OZONE	
SV1 075 3881 PH	HIDROZONE 75 with pH & Redox Controller HIDROZONE 75 con Control del pH y Redox HIDROZONE 75 avec Contrôle du pH et Redox	1
SV2 150 3881 PH	HIDROZONE 150 with pH & Redox Controller HIDROZONE 150 con Control del pH y Redox HIDROZONE 150 avec Contrôle du pH et Redox	1
SV3 200 3881 PH	HIDROZONE 200 with pH & Redox Controller HIDROZONE 200 con Control del pH y Redox HIDROZONE 200 avec Contrôle du pH et Redox	1
SV3 250 3881 PH	HIDROZONE 250 with pH & Redox Controller HIDROZONE 250 con Control del pH y Redox HIDROZONE 250 avec Contrôle du pH et Redox	1
SV1 075 3881 CD	HIDROZONE 75 (with conductivity tester) HIDROZONE 75 (con sensor de conductividad) HIDROZONE 75 (avec testeur de conductivité)	1
SV2 150 3881 CD	HIDROZONE 150 (with conductivity tester) HIDROZONE 150 (con sensor de conductividad) HIDROZONE 150 (avec testeur de conductivité)	1
SV3 200 3881 CD	HIDROZONE 200 (with conductivity tester) HIDROZONE 200 (con sensor de conductividad) HIDROZONE 200 (avec testeur de conductivité)	1
SV3 250 3881 CD	HIDROZONE 250 (with conductivity tester) HIDROZONE 250 (con sensor de conductividad) HIDROZONE 250 (avec testeur de conductivité)	1

* The Hydrolysis with Ozone equipment, provides a disinfection of the water without needing chemical products, being based on the conductivity of the water. In situations where the conductivity is reduced, is recommended to be added a minimum of 1.5 g of salts/l to secure the optimal conductivity of the water that the equipment needs to work properly.

* El equipo de Hidrólisis con Ozono proporciona una desinfección del agua sin necesidad de productos químicos, basándose en la conductividad del agua. En situaciones donde la conductividad es reducida, se pueden añadir un mínimo de 1,5 g de sales/l para conseguir la conductividad óptima de trabajo para el equipo.

* L'équipement d'Hydrolyse avec Ozone fournit une désinfection de l'eau sans avoir besoin de produits chimiques, en se basant sur la conductivité de l'eau. Dans des situations où la conductivité est réduite, on peut ajouter un minimum de 1.5 g de sel/l pour obtenir la conductivité minimale de travail pour l'équipement.

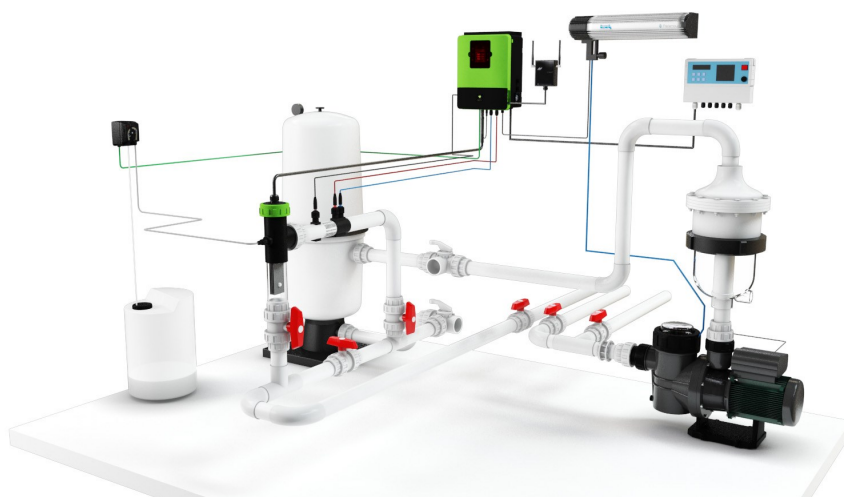

BASIC INSTALLATION DIAGRAM
ESQUEMA BÁSICO DE INSTALACIÓN
INSTALLATION DE BASE



HIDROZONE COMMERCIAL
HIDROZONE COMERCIAL



HIDROZONE RESIDENTIAL
HIDROZONE RESIDENCIAL
HIDROZONE RÉSIDENTIEL

SMART SOLARIX - SOLAR ENERGY SYSTEM
SMART SOLARIX - SISTEMA DE ENERGÍA SOLAR
SMART SOLARIX - SYSTÈME D'ÉNERGIE SOLAIRE



Code Código Code	Product Description Descripción Producto Désignation des Articles	Case Qty. Unid. Caja Unit. Boîte
------------------------	---	--

	SOLARIX Solar Water Heater for home and pool SOLARIX Calentador Solar de agua para casa y piscina SOLARIX Chauffe—eau Solaire pour maison et piscine	
SLX 300 220V SC	SOLARIX Water Heater—300 L SOLARIX Calentador de Agua—300 L SOLARIX Chauffe d'Eau—300 L	1
SLX 800 220V CT	SOLARIX Water Heater—800 L SOLARIX Calentador de Agua—800 L SOLARIX Chauffe d'Eau—800 L	1
SLX 10M 220V CT	SOLARIX Water Heater—1000 L SOLARIX Calentador de Agua—1000 L SOLARIX Chauffe d'Eau—1000 L	1
SLX 16M 220V CT	SOLARIX Water Heater—1600 L SOLARIX Calentador de Agua—1600 L SOLARIX Chauffe d'Eau—400 L	1
SLX 20M 220V CT	SOLARIX Water Heater—2000 L SOLARIX Calentador de Agua—2000 L SOLARIX Chauffe d'Eau—2000 L	1



* Smart Solarix System is a Solar based energy system that heat the water for homes and pools. The water heated is used for sanitary use (shower, bathroom, kitchen...etc.), for heating the home and for heating the pool with green energy. Can reduce up to 80% the regular energy costs. Smart Solarix is a kit that come complete with all components.

* El Sistema Smart Solarix está basado en la energía solar que se utiliza para calentar el agua para casas y piscinas. El agua calentada es destinada al uso sanitario (duchas, baños, cocinas...etc.), para la calefacción de la vivienda y para calentar la piscina con energía removable. Puede reducir los costes energeticos en hasta el 80%. Smart Solarix se suministra en un Kit Completo con todos sus componentes.

* Solarix Smart System est basé sur l'énergie solaire utilisée pour chauffer l'eau pour les maisons et les piscines. L'eau chauffée est destiné à un usage domestique (douches, salles de bains, cuisines ... etc.), pour le chauffage domestique et pour chauffer la pis-cine avec l'énergie renouvelable. Peut réduire les coûts énergétiques jusqu'à 80%. Smart Solarix est fourni dans un kit complet avec toutes ses composantes.

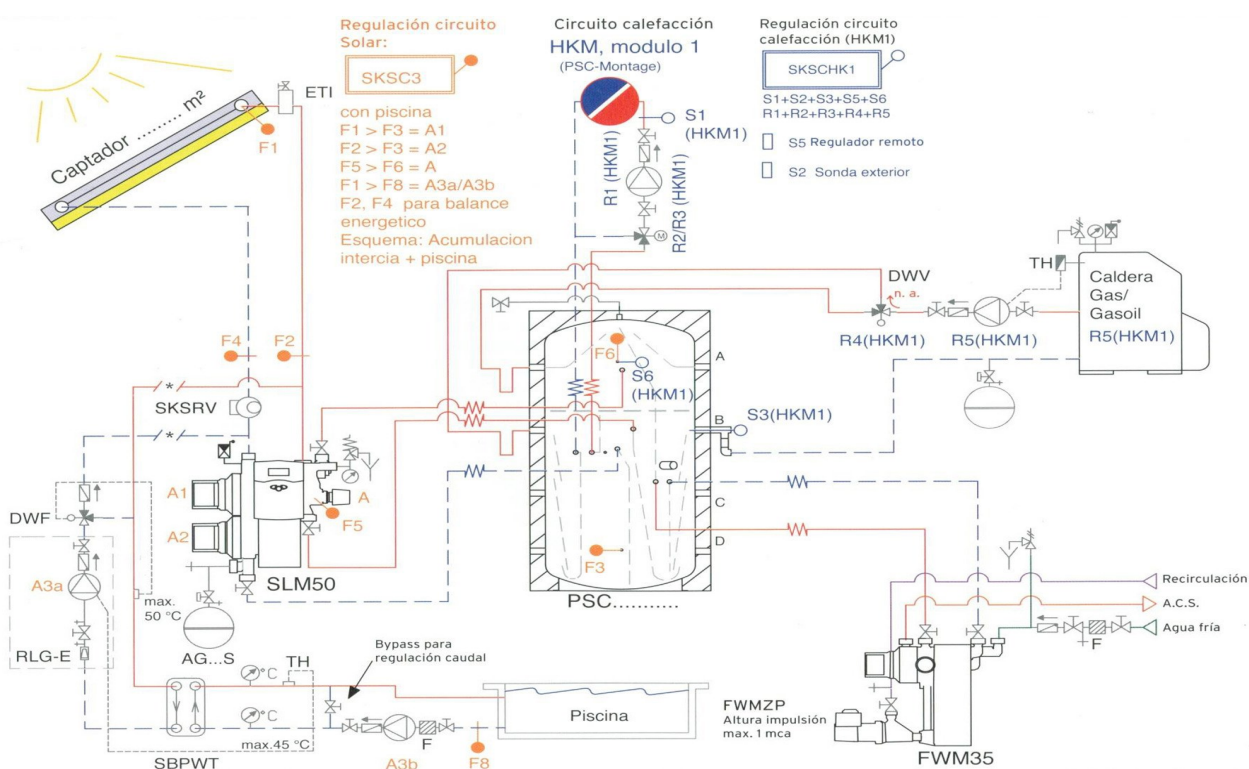

SMART POOLS PRODUCTS
SMART POOLS PRODUCTOS
SMART POOLS PRODUITS

Code Código Code	Product Description Descripción Producto Désignation des Articles	Case Qty. Unid. Caja Unit. Boîte
------------------------	---	--

Universal Pool Return Fittings Retornos para Empotrar Refolements a Sceller		
UEP SGT0 01	SWING JET Return Fitting for 1 1/2" thread SWING JET Retorno para 1 1/2" rosca SWING JET Refoulement 1 1/2" fil	1
UEP VGT0 01	VECTOR JET COMPLETE KIT VECTOR JET KIT COMPLETO VECTOR JET COMPLETE KIT	1
UERH 50001	Aquadaptor Return Fitting for 50 mm PN10 PVC Pipe Retorno 50 mm encolar en PVC 50 mm PN10 Refolement 50 mm pour PVC 50 mm PN10	12



SWING JET

* **SWING JET** is a special wall return fitting that rotate in 3 steps and 90°. **VECTOR JET** is a Floor Jet who can be set up to rotate between 22,5° to 360° to clean special zones. **Aquadaptor** has four function eyeball kits for new and existing pools. Each kit features a pressure test/winter plug, 90 degree down jet, regular 3/4" eyeball and high pressure cone. Available to suit 1 1/2" threaded adaptors retro and new. Also available as a self aligning insider to suit 1 1/2" Sch40 & Sch200 pipes. Lines up flush to the pool wall regardless of pipe angle.

* **SWING JET** es una boquilla de retorno de pared, que gira automáticamente en 3 pasos hasta 90°. **VECTOR JET** es una boquilla de fondo que se puede configurar para que gire desde 22,5° hasta 360° para poder limpiar zonas especiales. **Aquadaptor** es un Kit de cuatro adaptadores con chorros orientables para las piscinas nuevas y existentes. Cada kit ofrece un tapon para la prueba de presión o invierno, chorro 90 grados, chorro regular de 3/4" y cono de alta presión. Se alinea al ras de la pared de la piscina sin importar el ángulo de la tubería.

- **SWING JET** est une buse de refolement de paroi qui pivoté automatiquement en 3 étapes à 90°. **VECTOR JET** est une buse de fonds qui peut être configuré pour faire tourner de 22,5 ° à 360 ° pour nettoyer les zones spéciales. **Aquadaptor** sont Jets orientables pour nouvelles piscines ou existantes, avec quatre fonctions. Chaque kit comprend: 1 bouchon pour le test de pression/hiver, 90 degrees jet en bas, jet régulier 3/4" et cône a haute pression. S'aligne a niveau avec le mur de la piscine indépendamment de l'angle du tuyaux.



VECTOR JET COMPLETE KIT
VECTOR JET KIT COMPLETO



AQUADAPTOR RETURN FITTING
RETORNO AQUADAPTOR
REFOULEMENT AQUADAPTOR

VECTOR JET CLEANING A BEACH
VECTOR JET LIMPIADO UNA PLAYA
VECTOR JET NETTOYE UNE PLAGE

