

# WALL ASSEMBLIES [BRA] CLAMPS & TOPS [BRD] [RMA]

CONJUNTOS MURALES - BRIDAS & REMATES

## [BRA] Brackets



136

BRA-81



136

BRA-70



137

BRA-4000  
BRA-4400



138

BRA-1600



136

BRA-2200



136

BRA-71



137

BRA-5400



138

BRA-1800



136

BRA-21100



136

BRA-85



137

BRA-2300



138

BRA-1000



138

BRA-1100



139

BRA-5100



141

BRA-5500



138

BRA-1200



140

BRA-5200

### [BRD] Clamps



BRD-K



BRD-KT



BRD-SM

142

BRD-KL



138

BRA-3000



140

BRA-88

### [RMA] Tops



139

BRA-5000



141

BRA-5300



RMA-300

RMA-400

RMA-500

RMA-568

RMA-700

143

# BRA/NL

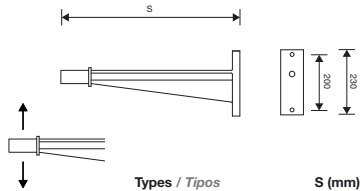

Types / Tipos	S (mm)
BRA-811 LP	600
BRA-812 LP	1000

Vertical and suspended fixations also available  
(replace LP for AP for vertical or SP for suspended)

Fijación vertical y suspendida también disponibles  
(reemplazar LP por AP para vertical o SP para suspendida)



## BRA-81

Cast Aluminium\*  
Fundición de Aluminio\*

\* Also available in Galvanized Steel  
\* También disponible en Acero Galvanizado

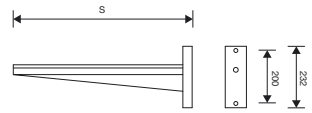

Types / Tipos	S (mm)
BRA-22070	600
BRA-22100	1000



## BRA-2200

Cast Aluminium\*  
Fundición de Aluminio\*

\* Also available in Galvanized Steel  
\* También disponible en Acero Galvanizado

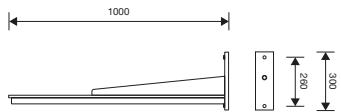

## BRA-21100

Cast Aluminium\*  
Fundición de Aluminio\*

\* Also available in Galvanized Steel  
\* También disponible en Acero Galvanizado

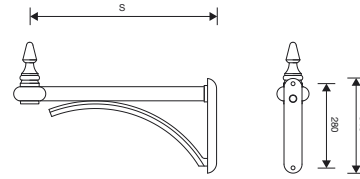

Types / Tipos	S (mm)
BRA-701	600
BRA-703	800



## BRA-70

Cast Aluminium  
Fundición de Aluminio

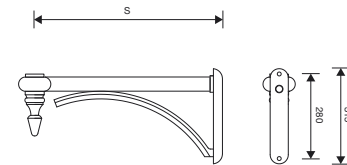

Types / Tipos	S (mm)
BRA-711	600
BRA-713	800



## BRA-71

Cast Aluminium  
Fundición de Aluminio

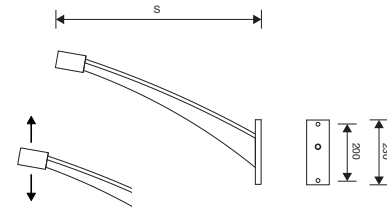

Types / Tipos	S (mm)
BRA-8560 LP	600
BRA-85100 LP	1000



## BRA-85

Cast Aluminium  
Fundición de Aluminio

Vertical and suspended fixations also available  
(replace LP for AP for vertical or SP for suspended)

Fijación vertical y suspendida también disponibles  
(reemplazar LP por AP para vertical o SP para suspendida)

 HISTORICAL CENTERS  
CENTROS HISTÓRICOS

 URBAN MODERN DESIGN  
DISEÑO URBANO MODERNO

 RESIDENTIAL  
ZONAS RESIDENCIALES

 PEDESTRIAN AREAS  
ZONAS PEATONALES

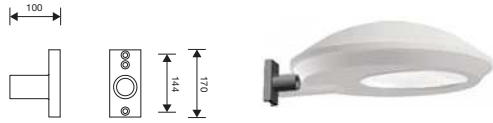

### BRA-4000

Cast Iron  
Fundición de Hierro

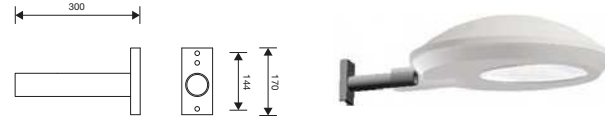

### BRA-4400

Galvanized Steel  
Acero Galvanizado

10° Tilt available  
Posibilidad de 10° de inclinación

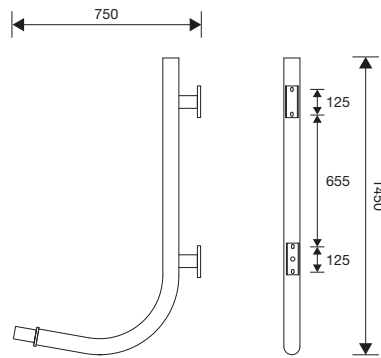

### BRA-5400

Galvanized Steel  
Acero Galvanizado

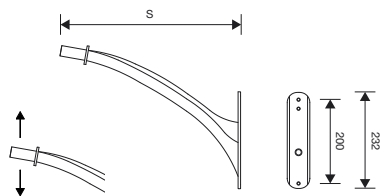

### BRA-2300

Cast Aluminium\*  
Fundición de Aluminio\*

Types / Tipos	S (mm)
BRA-23501 LP	500
BRA-23701 LP	700

Vertical and suspended fixations also available  
(replace LP for AP for vertical or SP for suspended)

Fijación vertical y suspendida también disponibles  
(reemplazar LP por AP para vertical o SP para suspendida)

\* Also available in Galvanized Steel  
\* También disponible en Acero Galvanizado



# BRA/NL

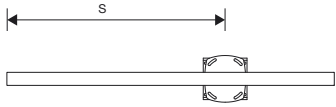

Types / Tipos	S (mm)
BRA-1600	Customizable

Support fixing through clamp BRD-SM  
Fijación a soporte mediante brida BRD-SM



## BRA-1600

Galvanized Steel  
Acero Galvanizado

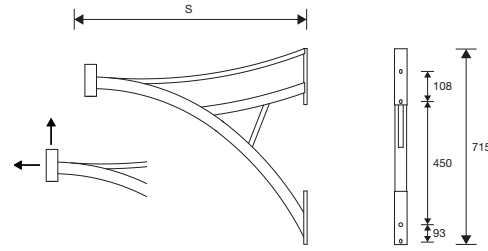

Types / Tipos	S (mm)
BRA-1170 SP	700
BRA-11100 SP	1000

Vertical and lateral fixations also available  
(replace SP for AP for vertical or LP for lateral)  
Fijación vertical y lateral también disponibles  
(reemplazar SP por AP para vertical o LP para lateral)



## BRA-1100

Galvanized Steel  
Acero Galvanizado

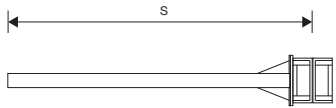

Types / Tipos	S (mm)
BRA-1800	Customizable

Support fixing through clamp BRD-SM  
Fijación a soporte mediante brida BRD-SM



## BRA-1800

Galvanized Steel  
Acero Galvanizado

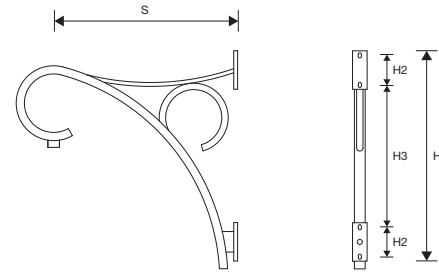

Types / Tipos	S (mm)	H1 (mm)	H2 (mm)	H3 (mm)
BRA-1270	700	850	115	555
BRA-12100	1000	1200	115	905



## BRA-1200

Galvanized Steel  
Acero Galvanizado

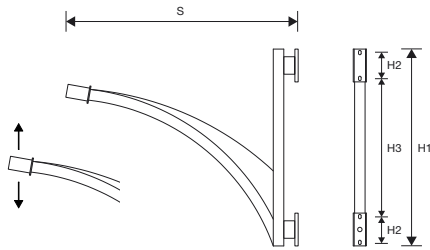

Types / Tipos	S (mm)	H1 (mm)	H2 (mm)	H3 (mm)
BRA-1070 LP	700	570	118	302
BRA-10100 LP	1000	905	118	637
BRA-10150 LP	1500	1260	118	970

Vertical and suspended fixations also available  
(replace LP for AP for vertical or SP for suspended)

Fijación vertical y suspendida también disponibles  
(reemplazar LP por AP para vertical o SP para suspendida)



## BRA-1000

Galvanized Steel  
Acero Galvanizado

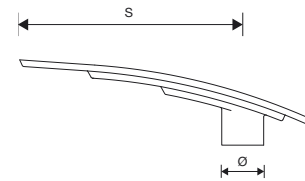

Types / Tipos	S (mm)	Ø* (mm)
BRA-3070	700	127-130-140-152
BRA-30100	1000	127-130-140-152

\* Ø of the support.



## BRA-3000

Cast Aluminium  
Fundición de Aluminio

 HISTORICAL CENTERS  
CENTROS HISTÓRICOS

 URBAN MODERN DESIGN  
DISEÑO URBANO MODERNO

 RESIDENTIAL  
ZONAS RESIDENCIALES

 PEDESTRIAN AREAS  
ZONAS PEATONALES

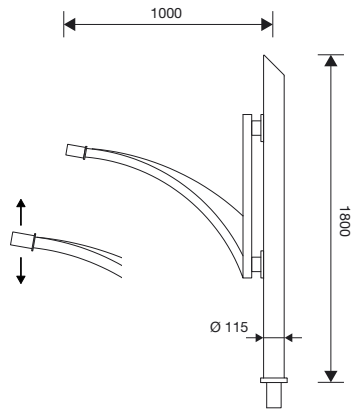

Vertical and suspended fixations also available  
(replace LP for AP for vertical or SP for suspended)  
*Fijación vertical y suspendida también disponibles  
(reemplazar LP por AP para vertical o SP para suspendida)*



**BRA-5000 LP**  
Galvanized Steel  
Acero Galvanizado

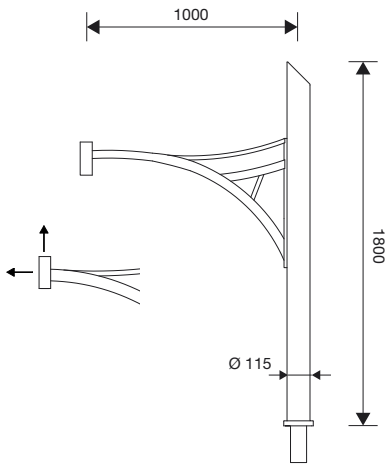

Vertical and lateral fixations also available  
(replace SP for AP for vertical or LP for lateral)  
*Fijación vertical y lateral también disponibles  
(reemplazar SP por AP para vertical o LP para lateral)*



**BRA-5100 SP**  
Galvanized Steel  
Acero Galvanizado



# BRA/NL

140

ROSLIGHTING

STREET LIGHTING SOLUTIONS  
www.roslighting.com

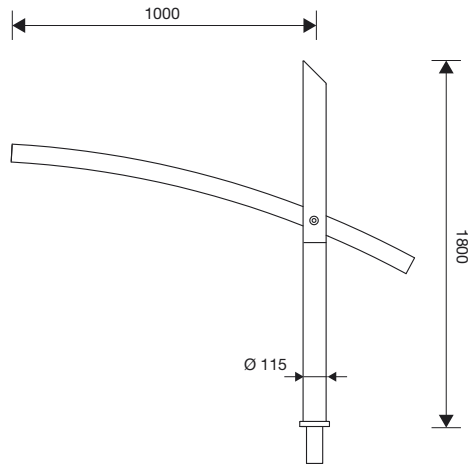

**BRA-5200**  
Galvanized Steel  
Acero Galvanizado

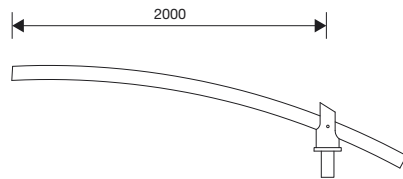
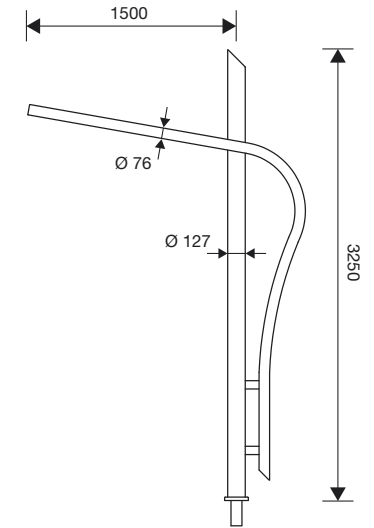

**BRA-88**  
Galvanized Steel  
Acero Galvanizado

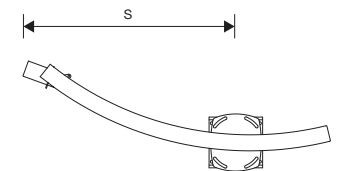

Direct fixing on pole top.  
Only for CRA-3000 poles.  
Fijado directamente a la parte superior del fuste.  
Únicamente para columnas de la serie CRA-3000.

Types / Tipos	S (mm)
BRA-55105	600
BRA-55150	800

Support fixing through clamp BRD-SM  
Fijación a soporte mediante brida BRD-SM

 HISTORICAL CENTERS  
CENTROS HISTÓRICOS

 URBAN MODERN DESIGN  
DISEÑO URBANO MODERNO

 RESIDENTIAL  
ZONAS RESIDENCIALES

 PEDESTRIAN AREAS  
ZONAS PEATONALES



**BRA-5300**  
Galvanized Steel  
*Acero Galvanizado*



**BRA-5500**  
Galvanized Steel  
*Acero Galvanizado*





Clamps  
Bridas

# BRD/NL

142

ROS  
STREET LIGHTING SOLUTIONS  
www.roslighting.com

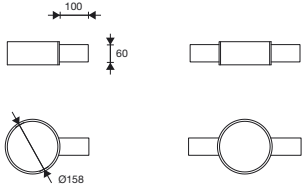

## BRD-K

Cast Iron  
Fundición de Hierro

Designed for CRA/ET-1000 pole  
Diseñada para su uso en columna CRA/ET-1000

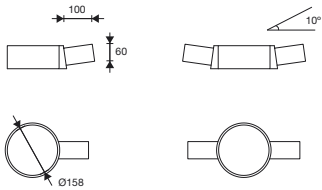

## BRD-KT

Cast Iron  
Fundición de Hierro

Designed for CRA/ET-1000 pole  
Diseñada para su uso en columna CRA/ET-1000

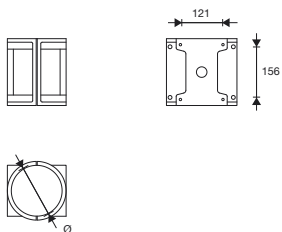

## BRD-KL/SM

Cast Iron  
Fundición de Hierro

Types / Tipos	Ø (mm)
BRD-KL	168
BRD-SM	127-130-140-152

Various Diameters  
Diferentes Diámetros

# RMA/NL

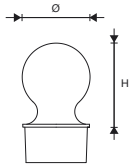

**RMA-300**

Types / Tipos	Ø (mm)	H (mm)
RMA-352	152	190
RMA-340	140	175
RMA-327	127	157
RMA-315	115	142

Cast Aluminium  
Fundición de Aluminio



**RMA-400**

Types / Tipos	Ø (mm)
RMA-410	100
RMA-412	120
RMA-414	140

Polished Brass  
Latón pulido

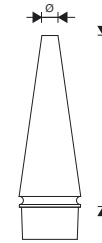

**RMA-700**

Types / Tipos	Ø (mm)	H (mm)
RMA-770/152	55	733
RMA-750/127	40	525
RMA-730/115	30	320
RMA-730/100	20	165
RMA-715/76	20	165

Cast Aluminium  
Fundición de Aluminio

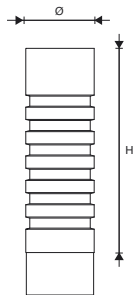

**RMA-500**

Types / Tipos	Ø (mm)	H (mm)
RMA-552*	152	455
RMA-540	140	420
RMA-527*	127	385
RMA-515*	115	350
RMA-510	100	300
RMA-508	76	250

Cast Aluminium  
Fundición de Aluminio

\*Cast Iron  
\*Fundición de Hierro

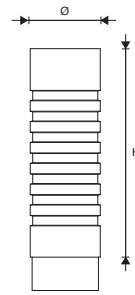

**RMA-568**

Types / Tipos	Ø (mm)	H (mm)
RMA-568/1	168	500
RMA-568/2	168	350

Cast Iron  
Fundición de Hierro  
Designed for CRA/ET-100 pole  
Diseñado para columna CRA/ET-1000

