

Fiber Optics

www.afo.es

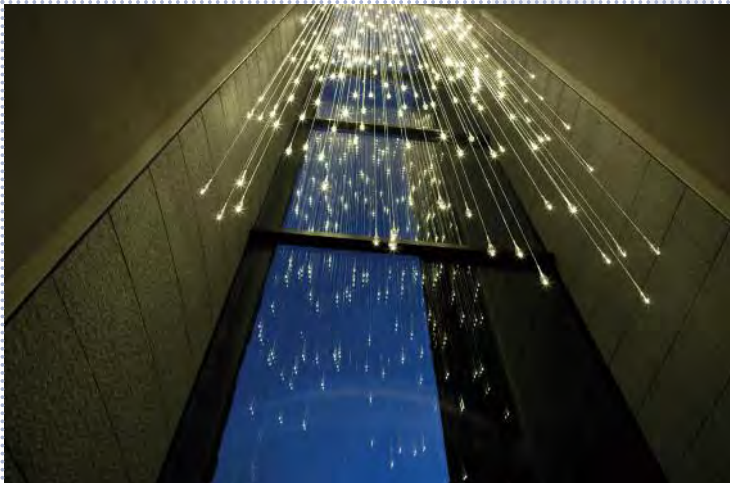

ADVANCED[®]
FIBER OPTICS



All images appearing in the Advanced Fiber Optics Catalogue site are copyrighted © 2001 – 2010 and the exclusive property of Advanced Fiber Optics distributors, clients and collaborators and protected under International Copyright laws.
The images may not be reproduced, copied, transmitted or manipulated without the written permission of the copyright holder(s).
Cover photograph © Bruce Munro.

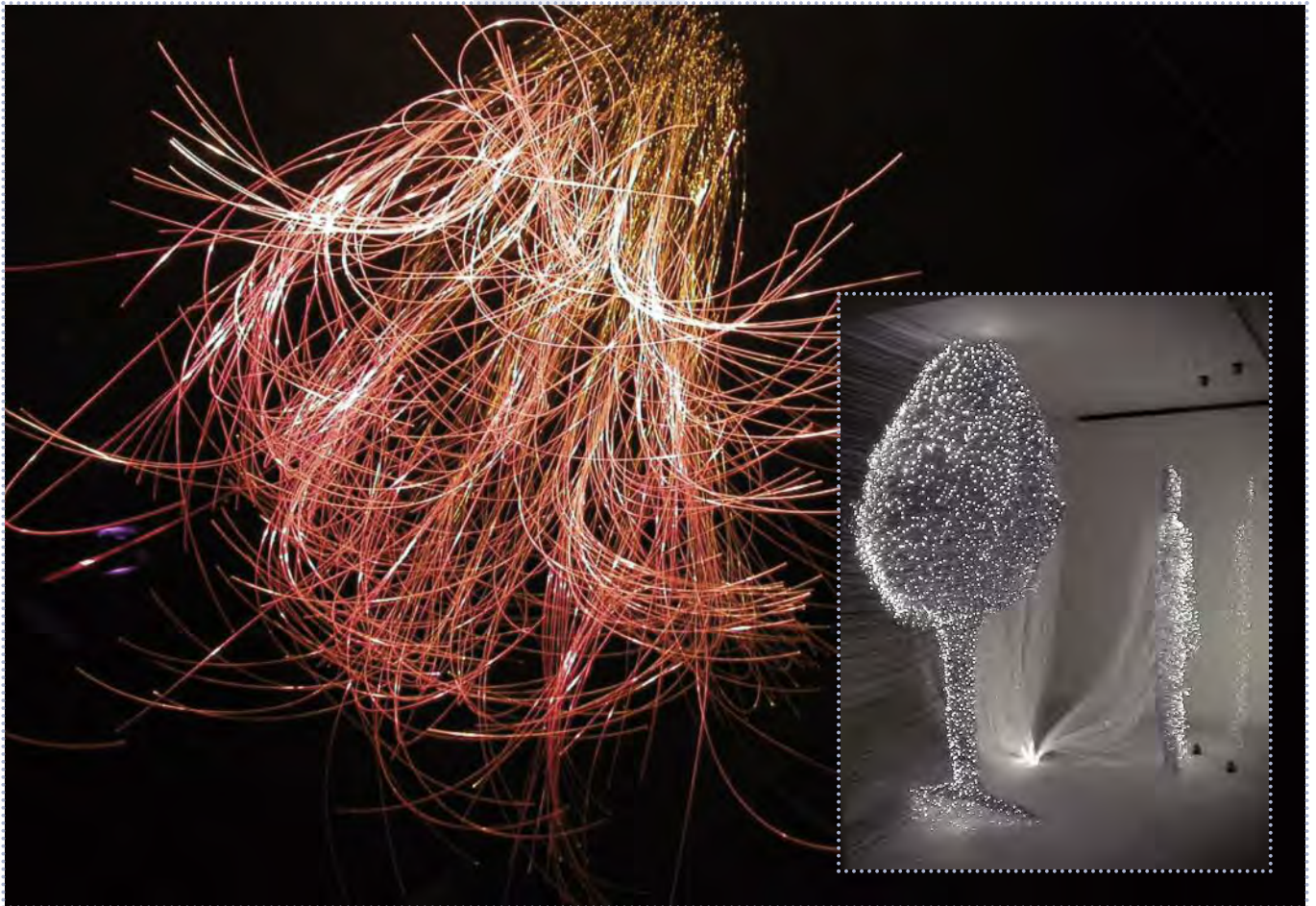

Bare Fibers | Fibras Desnudas

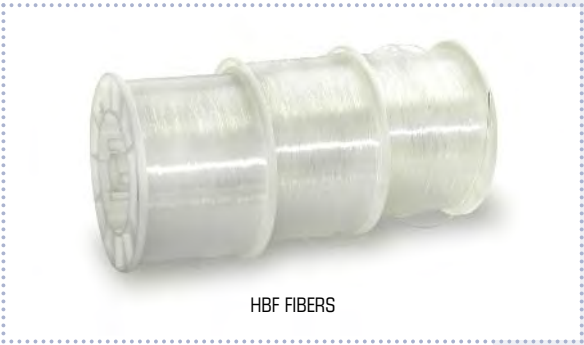

High performance bare fibers (PMMA) from Ø0,25mm to 3mm. For decorative applications such as star ceilings, and uses in protected areas where there is no danger of mechanical damage. Available in boxes, spools, cut sizes or assembled into harnesses.

Fibras ópticas desnudas (PMMA) de alto rendimiento de Ø0,25mm a 3mm. Para usos en instalaciones decorativas, como cielos estrellados, o en áreas protegidas de posibles daños mecánicos. Disponibles en cajas, bobinas, cortadas a medida o en mazos.

SERIES	PRODUCT	SPOOL SIZE	PACKING
HBF100	High performance bare fiber 0,25mm	12000m	4 spools
HBF200	High performance bare fiber 0,50mm	6000m	4 spools
HBF300	High performance bare fiber 0,75mm	2700 or 9000m	4 / 2 spools
HBF400	High performance bare fiber 1,00mm	1500 or 5250m	4 / 2 spools
HBF500	High performance bare fiber 1,50mm	700 or 2000m	4 / 2 spools
HBF600	High performance bare fiber 2,00mm	1290m	2 spools
HBF700	High performance bare fiber 3,00mm	150 or 450m	4 / 2 spools

Special discounts for bulk orders.

Clad Fibers | Fibras Recubiertas



High performance clad fibers (PMMA) from Ø1mm to 3mm. For decorative and lighting applications where mechanical protection or fire retarding is desired. Polyolefine HFFR cladding.

Fibras ópticas recubiertas (PMMA) de alto rendimiento, de Ø1mm a 3mm. Para instalaciones decorativas y de iluminación que exijan protección mecánica y/o resistencia al fuego. Funda de poliolefina HFFR.

CODE	PRODUCT	OUTER Ø	PACKING
HCF201*	High performance clad fiber 1,00mm	3mm	1000m
HCF301*	High performance clad fiber 1,50mm	3,5mm	500m
HCF401*	High performance clad fiber 2,00mm	4mm	500m
HCF501*	High performance clad fiber 3,00mm	5mm	450m

* Polyolefine HFFR cladding (Halogen Free Fire Retardant).



Light Guides | Guías Ópticas



High performance (PMMA) light guides comprising multiple endlight fibers ideal for general lighting projects. Any other architecture or configuration can be custom manufactured on request. Subject to minimum spool lengths.

Guías de fibras ópticas (PMMA) de alto rendimiento compuestas de múltiples fibras. Para usos en esquemas de iluminación en general. Cualquier otra configuración o arquitectura disponible bajo pedido mínimo de la longitud contenida en las bobinas.

CODE	PRODUCT	OUTER Ø	STRUCTURE	PACKING
HLG101*	High performance light guide, optical Ø3,00mm	6mm	12 x 0,75mm	500m
HLG201*	High performance light guide, optical Ø5,00mm	8mm	19 x 1,00mm	200m
HLG301*	High performance light guide, optical Ø6,50mm	10mm	33 x 1,00mm	100m
HCG075**	High performance light guide, optical Ø8,00mm	12mm	75 x 0,75mm	100m
SSL050*	Starry sky light guide, optical Ø8,00mm	10mm	50 x various	100m

* Polyolefine HFFR cladding (Halogen Free Fire Retardant). ** PVC cladding.



Glass Light Guides | Guías Ópticas de Vidrio



Glass endlight guides for lighting uses where a small bending radius, specific color rendition or heat resisting tip is needed*. Not recommended for lengths in excess of five meters. Various other diameters and custom sizes available on request.

Guías de vidrio de luz puntual para proyectos con ángulos de curvatura cerrados, exigencias en rendimiento cromático o resistencia al calor de las puntas*. Se recomienda no exceder longitudes de más de cinco metros. Otros diámetros y arquitecturas bajo demanda.

CODE	PRODUCT	STRUCTURE	PACKING
GLG101	Glass light guide 1,00mm	150	Ready-made harnesses
GLG201	Glass light guide 1,50mm	300	Ready-made harnesses
GLG301	Glass light guide 2,00mm	600	Ready-made harnesses
GLG401	Glass light guide 3,00mm	1400	Ready-made harnesses
GLG501	Glass light guide 4,00mm	2400	Ready-made harnesses
GLG601	Glass light guide 5,00mm	3600	Ready-made harnesses
GLG701	Glass light guide 7,00mm	7200	Ready-made harnesses

On request also available in spools and cut lengths.

* Glass light guides are clad in PVC or HFFR. With the exception of the fiber ends, their fire and heat resistance is the same as that of polymer conductors, White light transmission is much lower than that of polymer fibers.

Microbraid™ Sidelight Guides | Guías Microbraid™ de Iluminación Lateral

HMG101

HMG201

HMG301

HMG401



Microbraid™ (PMMA) sidelight fibers for decorative outlines, cove-lighting, neon simulation and pool edge lighting. The clear PVC cladding has UV, fungicide and algae protection.

Guías Microbraid™ (PMMA) de luz lateral para iluminación decorativa e indirecta, simulación de neón y contornos de piscinas. Enfundadas en PVC transparente con protección UV, fungicida y alguicida

CODE	PRODUCT	STRUCTURE	PACKING
HMG101	Microbraid™ sidelight guide, external Ø8,00mm	16 x 0,75mm	100m
HMG201	Microbraid™ sidelight guide, external Ø10,00mm	48 x 0,75mm	100m
HMG301	Microbraid™ sidelight guide, external Ø14,00mm	80 x 0,75mm	50m
HMG401	Microbraid™ sidelight guide, external Ø18,00mm	144 x 0,75mm	50m

Other diameters, custom sizes and architectures available on request.

Other Sidelight Guides | Otras Guías Laterales

HSG301

HSG401

HSG501



Small diameter (PMMA) sidelight guides (HSG), for staircases and dark-areas such as cinemas. The clear PVC cladding has UV, fungicide and algae protection.

Guías de luz lateral (PMMA) de calibre reducidas (HSG), para escaleras y aplicaciones en zonas oscuras, cines, etc. Enfundadas en PVC transparente con protección UV, fungicida y alguicida.

CODE	PRODUCT	STRUCTURE	PACKING
HSG301	High performance sidelight guide, external Ø5,00mm	14 x 0,75mm	500m
HSG401	High performance sidelight guide, external Ø6,00mm	12 x 0,75mm	500m
HSG501	High performance sidelight guide, external Ø4,00mm	7 x 0,75mm	500m
HSG601	High performance sidelight guide, external Ø3,00mm	5 x 0,75mm	500m
PSF101	High performance sidelight guide, external Ø2,00mm	1 x 1,00mm	1500m

On request also available with fire security stainless steel cable.

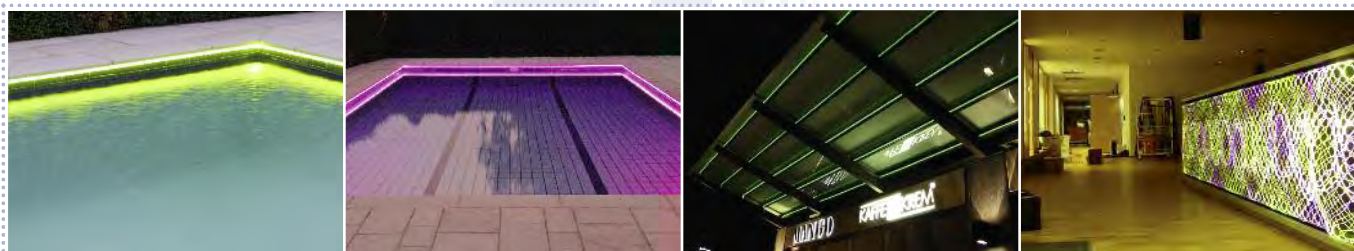

Sparkle PMMA Guides | Guías Destellantes de PMMA



Sparkle PMMA sidelight guides, for decorative features, such as chandeliers, backdrops and curtains. The clear PVC cladding has UV, fungicide and algae protection. Other architectures and configurations available on request.

Guías destellantes de PMMA para aplicaciones decorativas verticales, como luminarias, hachones y cortinas. Enfundadas en PVC transparente con protección UV, fungicida y alguicida. Otras arquitecturas y configuraciones disponibles bajo pedido.

CODE	PRODUCT	STRUCTURE	PACKING
SSF103	Sparkling sidelight guide, external Ø6,00mm	12 x 0,75mm	250m
SSF101	Sparkling sidelight guide, external Ø4,50mm	7 x 0,75mm	250m
SSF102	Sparkling sidelight guide, external Ø3,00mm	4 x 0,75mm	500m
SSF201	Sparkling sidelight guide, external Ø2,00mm	1 x 1,00mm	1500m
SSF222	Bare sparkling sidelight fiber Ø0,75mm	1 x 0,75mm	2700m
SSF221	Bare sparkling sidelight fiber Ø1,00mm	1 x 1,00mm	1500m

On request also available without cladding or with fire security stainless steel cable.

IMPORTANT SAFETY NOTICE: Suspending crystals and other heavy objects from polymer strands is dangerous. In the event of fastener failure or fire, a falling crystal can grievously harm passers-by. In public areas or in features with crystals suspended high in the air, guides with a security stainless steel cable should be used.



Sparkle Glass Guides | Guías Destellantes de Vidrio



Glass sparkle sidelight guides for chandeliers and decorative features. Other diameters and architectures available upon request.

Guías de vidrio destellantes de luz lateral para candelabros y esquemas decorativos. Otros diámetros y configuraciones disponibles bajo demanda.

CODE	PRODUCT	STRUCTURE	PACKING
SGG201	Sparkle sidelight guide 1,00mm	150	Ready-made harnesses
SGG301	Sparkle sidelight guide 1,12mm	200	Ready-made harnesses

On request available in spools and cut lengths.



Optical Ports | Puertos Ópticos



Optical port devices to connect fibers to the illuminator. Please see the illuminator specifications to choose the appropriate OPD. Consult us for fiber capacities.

Puertos ópticos para conectar las fibras ópticas al iluminador. Rogamos revisen las instrucciones del iluminador para determinar el OPD correspondiente. Consúltenos para capacidades de fibra.

CODE	PRODUCT	ILLUMINATOR	OPTICAL CAPACITY
OPD401	Optical port device	XXX, MHI, MDI100, MDI504, MDI800	Ø30mm
OPD111	Optical port device	MDI603	Ø20mm
OPD301	Optical port device	AHI Series	30 x 30mm

Custom, IP rated, and large-diameter optical ports available on request.



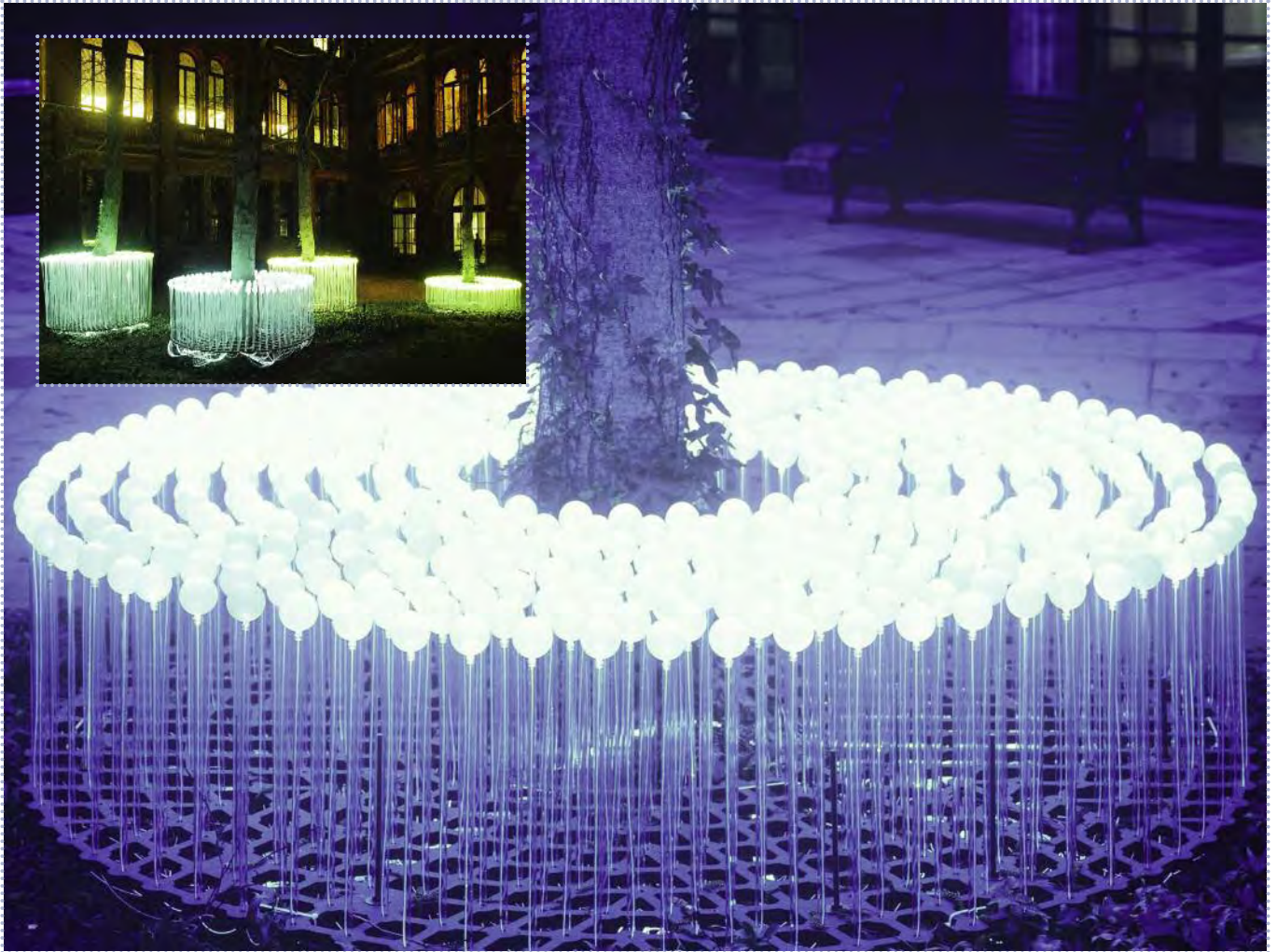

Dry Fusion System™ | Dry Fusion System™



The patented Dry Fusion System™ is what affords AFO dealers a competitive edge with on-site harness production. Easy to use, makes harnesses with superior quality and performance.

Dry Fusion System™ (Sistema de Fusión Seca) patentado que confiere a nuestros distribuidores la ventaja de fabricar y terminar mazos en obra. Fácil de utilizar para producir mazos de alta calidad.

CODE	PRODUCT	TYPE	VOLTAGE
DFS101	Complete dry fusion system with flightcase	Portable	220 / 240V
DFS102	Automatic dry fusion system	Portable	220 / 240V
DFS201	Control unit for four port slave unit DFS301	Bench	220 / 240V
DFS301	Four port slave unit for DFS201	Bench	N/A
DFS401	Compact dry fusion system	Portable	220 / 240V

Glass formers and other consumables available from our accessory range.



The right Illuminator for each job | El iluminador adecuado para cada aplicación

Illuminators are projectors designed to inject light into the fibers. Beside specific features, such as color change, flickering disks for starry skies, animation drums and IP rating for outdoor or indoor uses, the principal difference between different models is their light output. Applications such as lighting, and sidelight guides need powerful illuminators regardless of environmental constraint. Other applications, in particular decorative uses, will need more or less power as a function of ambient light, distance to the observer and importance.

Los iluminadores son proyectores diseñados para inyectar luz en las fibras. Además de características como cambio de color, discos de efectos para firmamentos, tambores de animación y clasificación IP para usos en exteriores o interiores, la principal diferencia entre los modelos es su potencia lumínica. Las aplicaciones de iluminación o de guías de emisión lateral precisan iluminadores potentes sin importar los condicionantes ambientales. Otros usos, decorativos en particular, necesitarán más o menos potencia en función de la iluminancia ambiente, distancia al observador y su importancia.

Illuminator	Hal. 50W	Hal. 75W	Hal. 100W	MH.150W	DMX	LED 1W	LED 8W
Starry skies, Decoration	Excellent	Excellent	Excellent	Limited	Limited	Limited	Excellent
Signs	Poor	Poor	Excellent	Excellent	Excellent	Poor	Excellent
Small details	Excellent	Excellent	Excellent	Limited	Poor	Limited	Excellent
Pools, Waterworks	Poor	Poor	Limited	Excellent	Excellent	Poor	Limited
Showcases	Limited	Limited	Excellent	Excellent	Poor	Poor	Limited
Lighting	Poor	Poor	Limited	Excellent	Excellent	Poor	Limited
Sidelight, Chandeliers, Curtains	Poor	Poor	Poor	Excellent	Excellent	Poor	Limited
Synchronized illuminators	Poor	Poor	Poor	Poor	Excellent	Poor	Limited

Basic Silent Illuminator | Iluminador Básico Silencioso



XXX SERIES

Basic halogen illuminator, for star ceilings requiring silent operation or an economical unit. Only available with 50W halogen lamp.

Iluminador halógeno básico, para cielos estrellados donde se requiera operación silenciosa o una alternativa económica. Solo disponible con lámpara de 50W.

CODE	PRODUCT	TYPE	POWER	VOLTAGE	DIMENSIONS
XXX001	Basic halogen illuminator	White light	50W	220 / 240V	L 245 x W 150 x H 140mm
XXX002	Basic halogen illuminator	Starry sky	50W	220 / 240V	L 245 x W 150 x H 140mm
XXX003	Basic halogen illuminator	Starry sky + color	50W	220 / 240V	L 245 x W 150 x H 140mm

On request, these illuminators can be equipped with high Kelvin, ultra-white cold light lamps for more realistic effects.

Also available at 12V AC.

Low-profile Halogen Illuminator | Iluminador Halógeno de Bajo Perfil



MHI600 SERIES

For showcases and any application in areas with limited space such as furniture or low-plenum suspended ceilings. Reduced noise.

Para vitrinas y aplicaciones en zonas de espacio reducido, como muebles o techos suspendidos con baja cota de instalación. Bajo nivel de ruido.

CODE	PRODUCT	TYPE	POWER	VOLTAGE	DIMENSIONS
MHI601	Low-profile halogen illuminator	White light	50W	220 / 240V	L 261 x W 140 x H 71mm
MHI602	Low-profile halogen illuminator	White light	75W	220 / 240V	L 261 x W 140 x H 71mm
MHI603	Low-profile halogen illuminator	White light	100W	220 / 240V	L 261 x W 140 x H 71mm

Single color filters on request.



Modular Halogen Illuminator | Iluminador Halógeno Modular



MHI SERIES

Standard halogen range of illuminators with IR filter, forced ventilation and thermal cut-out fuse. For decorative and general lighting.

Gama estándar de iluminadores halógenos con filtro de infrarrojo, ventilación forzada y fusible térmico. Para aplicaciones decorativas y de iluminación general.

CODE	PRODUCT	TYPE	POWER	VOLTAGE	DIMENSIONS
MHI101	Modular halogen illuminator	White light	50W	220 / 240V	L 217 x W 220 x H 140mm
MHI102	Modular halogen illuminator	Starry sky	50W	220 / 240V	L 217 x W 220 x H 140mm
MHI104	Modular halogen illuminator	6-color	50W	220 / 240V	L 217 x W 220 x H 140mm
MHI201	Modular halogen illuminator	White light	75W	220 / 240V	L 217 x W 220 x H 140mm
MHI202	Modular halogen illuminator	Starry sky	75W	220 / 240V	L 217 x W 220 x H 140mm
MHI204	Modular halogen illuminator	6-color	75W	220 / 240V	L 217 x W 220 x H 140mm
MHI301	Modular halogen illuminator	White light	100W	220 / 240V	L 217 x W 220 x H 140mm
MHI302	Modular halogen illuminator	Starry sky	100W	220 / 240V	L 217 x W 220 x H 140mm
MHI304	Modular halogen illuminator	6-color	100W	220 / 240V	L 217 x W 220 x H 140mm

On request, these illuminators can be outfitted with a low-noise fan.

Series 100 Modular Discharge Illuminator | Iluminador Modular de Descarga Serie 100



MDI100 SERIES

150W gas discharge illuminator for dry location with IR filter, forced ventilation and thermal cut-out fuse. For general lighting, pools, sidelight, chandeliers and very lofty star ceilings.

Iluminador modular de descarga de 150W con filtro de infrarrojo, ventilación forzada y fusible térmico. Para uso en interiores, iluminación general, piscinas, guías de iluminación lateral, chandeliers y cielos estrellados a gran altura.

CODE	RODUCT	TYPE	POWER	VOLTAGE	DIMENSIONS
MDI101	Modular discharge illuminator	White light	150W	220 / 240V	L 295 x W 291 x H 140mm
MDI102	Modular discharge illuminator	6-color	150W	220 / 240V	L 295 x W 291 x H 140mm
MDI105	Modular discharge illuminator	Starry sky	150W	220 / 240V	L 295 x W 291 x H 140mm

Philips CDM-R ceramic metal halide reflector lamp fitted as a standard.

On request, these illuminators can be outfitted with a low-noise fan, warm light filter and/or electronic ballast.

Animation Halogen Illuminator | Iluminador Halógeno de Animación



AHI SERIES

Range of illuminators from 50W to 100W with various motor speeds. For CES kits and other custom animations, such as signs. Needs OPD301 animation optical port.

Iluminadores de animación de 50 a 100W con diversas velocidades de motor. Para usos con CES y otras animaciones a medida tales como rótulos. Requiere el puerto óptico de animación OPD301.

CODE	PRODUCT	TYPE	POWER	VOLTAGE	DIMENSIONS
AHI101	Animation halogen illuminator	1 RPM	50W	220 / 240V	L 295 x W 291 x H 140mm
AHI102	Animation halogen illuminator	3 RPM	50W	220 / 240V	L 295 x W 291 x H 140mm
AHI103	Animation halogen illuminator	6 RPM	50W	220 / 240V	L 295 x W 291 x H 140mm
AHI201	Animation halogen illuminator	1 RPM	75W	220 / 240V	L 295 x W 291 x H 140mm
AHI202	Animation halogen illuminator	3 RPM	75W	220 / 240V	L 295 x W 291 x H 140mm
AHI203	Animation halogen illuminator	6 RPM	75W	220 / 240V	L 295 x W 291 x H 140mm
AHI301	Animation halogen illuminator	1 RPM	100W	220 / 240V	L 295 x W 291 x H 140mm
AHI302	Animation halogen illuminator	3 RPM	100W	220 / 240V	L 295 x W 291 x H 140mm
AHI303	Animation halogen illuminator	6 RPM	100W	220 / 240V	L 295 x W 291 x H 140mm

On request, these illuminators can be outfitted with a low-noise fan.

Low-profile Discharge Illuminator | Iluminador de Descarga de Bajo Perfil



MDI210 SERIES

150W gas discharge illuminator for dry location with IR filter, low-noise forced ventilation and thermal cut-out fuse. Very low profile for uses in showcases, museum lighting and ceilings with low plenum. White light of fixed color only.

Iluminador modular de descarga de 150W con filtro de infrarrojo, ventilación forzada, con bajo nivel de ruido y fusible térmico. Para uso en interiores, en vitrinas, iluminación de museos y techos con baja cota de instalación. Sólo disponible en luz blanca o color fijo.

CODE	PRODUCT	TYPE	POWER	VOLTAGE	DIMENSIONS
MDI210	Low-profile discharge illuminator	White light	75W	120 or 240V	L 288 x W 260 x H 100mm
MDI211	Low-profile discharge illuminator	White light	150W	120 or 240V	L 288 x W 260 x H 100mm

Rear lamp access for ease of maintenance. Single color filters on request.

Series 800 Modular Discharge Illuminator | Iluminador Modular de Descarga Serie 800



MDI800 SERIES

New generation of low-noise 150w gas discharge illuminator for wet or dry locations IP44 with electronic ballast for extended lamp life (10,000H) and a choice of configurations.

Iluminador de descarga de última generación, con lámpara de 150W para interior o exterior, IP44. Bajo nivel de ruido. Equipado con balasto electrónico para extender la vida de la lámpara (10.000H) y múltiples configuraciones.

CODE	PRODUCT	TYPE	POWER	VOLTAGE	DIMENSIONS
MDI801	Discharge illuminator	White light	150W	220 / 240V	L 340 x W 290 x H 180mm
MDI802	Discharge illuminator	8-color	150W	220 / 240V	L 340 x W 290 x H 180mm
MDI803	Discharge illuminator	8-color / synchronism	150W	220 / 240V	L 340 x W 290 x H 180mm
MDI804	Discharge illuminator	8-color / DMX	150W	220 / 240V	L 340 x W 290 x H 180mm
MDI805	Discharge illuminator	Starry sky	150W	220 / 240V	L 340 x W 290 x H 180mm

Philips CDM-R ceramic metal halide reflector lamp fitted as a standard. Available with DMX 512 control.

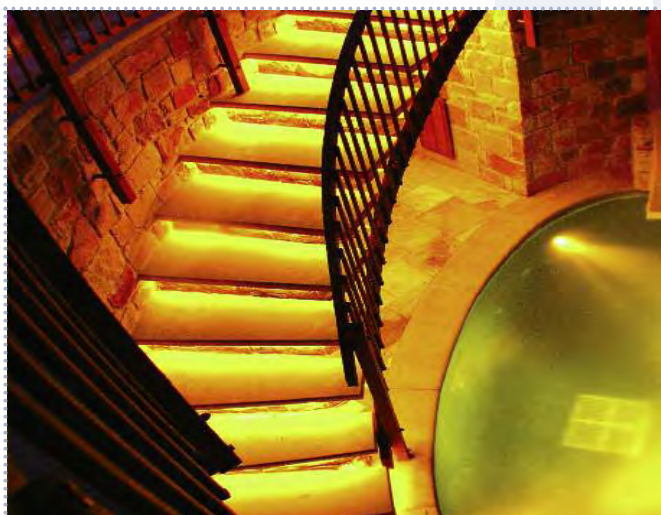



Series 600 Modular Discharge Illuminator | Iluminador Modular de Descarga Serie 600



150W gas discharge illuminator with IP54 rating for wet location. Includes remote control for on-off, color changes, sequential programmes and synchronism.

Iluminador de descarga de 150W con IP54 para uso en exteriores. Incluye control remoto para arranque y paro, cambio de color, programas secuenciales y sincronismo.

CODE	PRODUCT	TYPE	POWER	VOLTAGE	DIMENSIONS
MDI603	Discharge illuminator	Synchronous color change	150W	220 / 240V	L 365 x W 300 x H 540mm
Philips CDM-R ceramic metal halide reflector lamp fitted as a standard.					



Series 110 Modular Discharge Illuminator | Iluminador Modular de Descarga Serie 110



MDI110 SERIES

150W gas discharge illuminator for dry location with IR filter, forced ventilation and thermal cut-out fuse. For general lighting, pools, sidelight, chandeliers and very lofty star ceilings. With DMX 512 control.

Iluminador de descarga de 150W con filtro de infrarrojo, ventilación forzada y fusible térmico. Para uso en interiores, iluminación general, piscinas, guías de iluminación lateral, chandeliers y cielos estrellados a gran altura. Con control por protocolo DMX 512.

CODE	PRODUCT	TYPE	POWER	VOLTAGE	DIMENSIONS
MDI110	Modular discharge illuminator	8-color / DMX	150W	220 / 240V	L 300 x W 289 x H 150mm
Philips CDM-R ceramic metal halide reflector lamp fitted as a standard. Remote control available on request.					



Series 900 Modular Discharge Illuminator | Iluminador Modular de Descarga Serie 900



MDI900 SERIES

150W gas discharge illuminator IP43 for wet locations. With IR filter, forced ventilation and thermal cut-out fuse. 8-color. Casing in stainless steel. Key lock. For general lighting, pools, sidelight, chandeliers and very lofty star ceilings. With DMX 512 control.

Iluminador de descarga de 150W, IP 43 para exteriores con filtro de infrarrojo, ventilación forzada y fusible térmico. Para iluminación general, piscinas, guías de iluminación lateral, chandeliers y cielos estrellados a gran altura. Con control por protocolo DMX 512.

CODE	PRODUCT	TYPE	POWER	VOLTAGE	DIMENSIONS
MDI904	Discharge illuminator ARC 150 lamp	8-color / DMX	150W	220 / 240V	L 335 x W 328 x H 190mm
MDI914*	Discharge illuminator CDM / R lamp	8-color / DMX	150W	220 / 240V	L 335 x W 328 x H 190mm
Remote control and 110V operation available on request. * Philips CDM-R ceramic metal halide reflector lamp as a standard.					



Series 500 Modular Discharge Illuminator | Iluminador Modular de Descarga Serie 500



MDI500 SERIES

150W gas discharge illuminator, IP44 for wet location. With CMY color-mixing, DMX512, dimming, 2 real-time timers, light sensor, Can be controlled with MUM software (ACC802) or any DMX Controller. Millions of software-addressable colors.

Iluminador de descarga 150W, cambio de color CMY, DMX512, regulación, 2 temporizadores a tiempo real, sensor crepuscular e IP44. Control con aplicativo MUM (ACC802) o controladora DMX. Millones de colores controlados por software.

CODE	PRODUCT	TYPE	POWER	VOLTAGE	DIMENSIONS
MDI504	Modular discharge illuminator	CMY / DMX	150W	110 / 240V	L 398 x W 195 x H 197mm

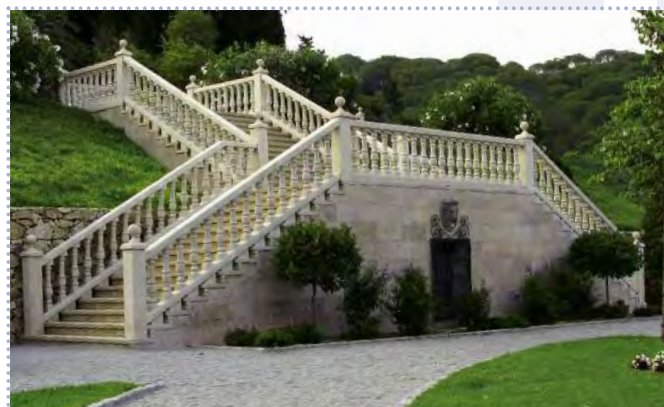

Animation LED Illuminator | Iluminador de Animación LED



ASI100 SERIES

Animation illuminator for miniature cosmic effects or starry skies. With Cree latest generation LED light sources. Optical port and driver included.

Iluminador de animación para efectos siderales o firmamentos en miniatura. Con fuente de luz LED Cree de última generación. Puerto óptico y fuente de alimentación incluida.

CODE	PRODUCT	TYPE	POWER	VOLTAGE	DIMENSIONS
ASI101	Animation LED illuminator	Animation	1,2W	220 / 240V	L 220 x W 144 x H 55mm
ASI102	Animation LED illuminator	Starry sky	1,2W	220 / 240V	L 220 x W 144 x H 55mm

Custom configurations available on request.

LED Illuminator | Iluminador LED



SSI600 SERIES

Illuminator powered with 1,2W LED in a light alloy body. Accepts up to 200 x 1mm fibers. Power supply not included.

Iluminador con un LED de 1,2W en cuerpo de aleación ligera. Acepta hasta 200 fibras de 1mm. Fuente de alimentación no incluida.

SERIES	PRODUCT	TYPE	POWER	VOLTAGE	DIMENSIONS
SSI600	LED illuminator	Static	1,2W	350mA	L 100 x Ø32mm
SSI610	LED illuminator	Static	2W	700 / 1000mA	L 120 x Ø40mm
SSI620	LED illuminator	Static	3W	700 / 1000mA	L 120 x Ø40mm

Power supply (LOP111) must be ordered separately.

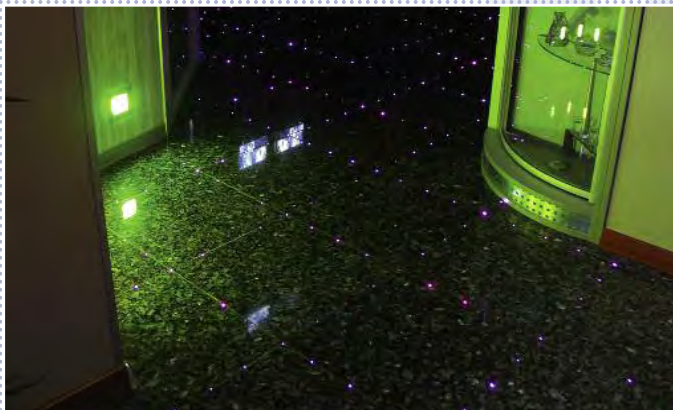

High Power LED Illuminator | Iluminador LED de Alta Potencia



HSI100 SERIES

HSI200 SERIES

18 / 30W compact size LED illuminator in light alloy case with forced ventilation. Accepts up to 600 x 1mm fibers. Very low noise. Available in white light, fixed colors and RGB with sequential or DMX 512 control.

Iluminador de 18 / 30W compacto LED y alta potencia en alojamiento de aleación ligera con ventilación forzada. Acepta hasta 600 fibras de 1mm. Bajo nivel de ruido. Disponible en luz blanca, colores fijos y RGB con cambio secuencial o mediante protocolo DMX 512.

CODE	PRODUCT	TYPE	POWER	VOLTAGE	DIMENSIONS
HSI101*	High power LED illuminator	White 5500°K	18W	Driver	L 124 x W 72 x H 57mm
HSI201	High power LED illuminator	White 6000°K	30W	Driver	L 124 x W 72 x H 57mm
HSI102	High power LED illuminator	RGB	18W	Driver	L 124 x W 72 x H 57mm

Drivers and controls must be ordered separately. * Available in 3200°K.



High Power LED Illuminator IP67 | Iluminador LED de Alta Potencia IP67



HSI300 SERIES

State-of-the-art illuminator for extreme applications, outdoors or even underwater with a luminous flux equivalent to that of a 100W halogen lamp. Exceedingly long life for installations requiring minimal maintenance.

Iluminador de última generación para aplicaciones en condiciones extremas en exteriores o sumergidas, con un flujo lumínico equivalente a una lámpara halógena de 100W. Larga vida media de los LED para instalaciones donde el mantenimiento sea complejo.

CODE	PRODUCT	TYPE	POWER	VOLTAGE	DIMENSIONS
HSI301	High power LED illuminator IP67	White 5500°K	18W	Driver	L 210 x W 140 x H 75mm*
HSI302	High power LED illuminator IP67	RGB	18W	Driver	L 210 x W 140 x H 75mm*

Drivers and controls must be ordered separately. * H 90mm with handle.

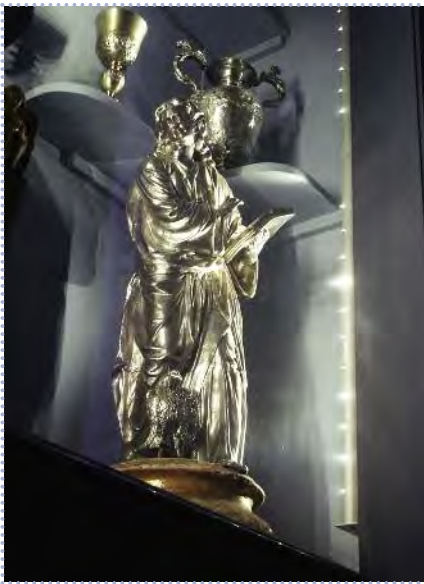

Adjustable Display Fittings | Apliques Orientables Interiores



Fittings for display cases, shops, and general lighting. Manufactured from light alloy with grey epoxy finish as standard. Custom finishes available on request.

Apliques para expositores, escaparates e iluminación general. Fabricados en aleación ligera con acabado en epoxi gris. Otros acabados disponibles bajo pedido.

CODE	PRODUCT	MATERIAL	FIT	FIBER Ø	OUTER Ø	FINISH
ADF451	Adjustable display fitting 30° lens	Light alloy	Spring	3 / 8mm	50mm	Gray epoxy
ADF452	Adjustable display fitting 60° no lens	Light alloy	Spring	3 / 8mm	50mm	Gray epoxy
ADF453	Adjustable display fitting 30° extended lens	Light alloy	Spring	3 / 8mm	50mm	Gray epoxy



Downlighter Fittings | Apliques Fijos



Range of downlighter fittings for cases and general lighting, with and without lenses and beam angles from 20 to 60°. Different models in light alloy or polymer. For 3mm or 5mm light guides.

Gama de apliques fijos para vitrinas e iluminación general con y sin lente y ángulos de proyección desde 20 a 60°. Diferentes modelos en aleación ligera o polímero. Para guías de 3 o 5mm.

CODE	PRODUCT	MATERIAL	FIT	FIBER Ø	OUTER Ø	FINISH
EDF101	Downlighter fitting 25° / 45°	Light alloy	Spring	2 / 5mm	31mm	Epoxi
EDF102	Downlighter fitting 25° / 45°	Polymer	Spring	2 / 5mm	51mm	Natural

Standard finishes: black, white, chrome, stainless steel.



Adjustable Display Fittings | Apliques Orientables Interiores



Range of light alloy fittings with different lens configurations for showcases and other applications requiring spotlighting. Natural finish. Other finishes available on request.

Gama de apliques en aleación ligera con diferentes configuraciones ópticas para vitrinas y otras aplicaciones que requieran iluminación puntual. Acabado natural. Otros acabados disponibles bajo pedido.

CODE	PRODUCT	MATERIAL	FIT	FIBER Ø	OUTER Ø	FINISH
ADF811	Adjustable display fitting	Light alloy	Spring	5mm	44mm	Bright anodized
ADF821	Adjustable display fitting	Light alloy	Spring	5mm	44mm	Bright anodized
ADF831	Adjustable display fitting	Light alloy	Spring	5mm	44mm	Bright anodized
ADF841	Adjustable display fitting	Light alloy	Spring	5mm	34mm	Bright anodized

Adjustable Display Fittings | Apliques Orientables Interiores

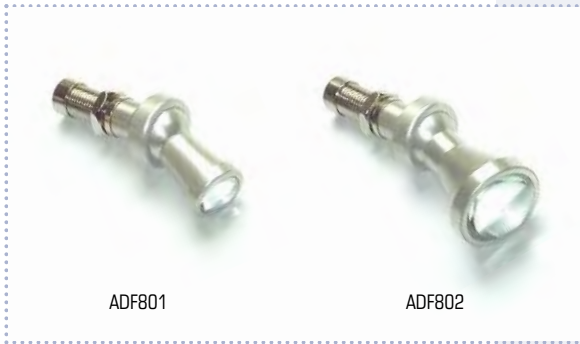

Articulated and adjustable light alloy fittings for display cases and other applications requiring spotlighting. Natural finish. Other finishes available on request.

Apliques articulados y ajustables en aleación ligera para vitrinas y otras aplicaciones que requieran iluminación puntual. Acabado natural. Otros acabados disponibles bajo pedido.

CODE	PRODUCT	MATERIAL	FIT	FIBER Ø	OUTER Ø	FINISH
ADF801	Adjustable display fitting 30° lens	Light alloy	Thread	3 / 5mm	18mm	Bright anodized
ADF802	Adjustable display fitting 20° lens	Light alloy	Thread	3 / 5mm	28mm	Bright anodized

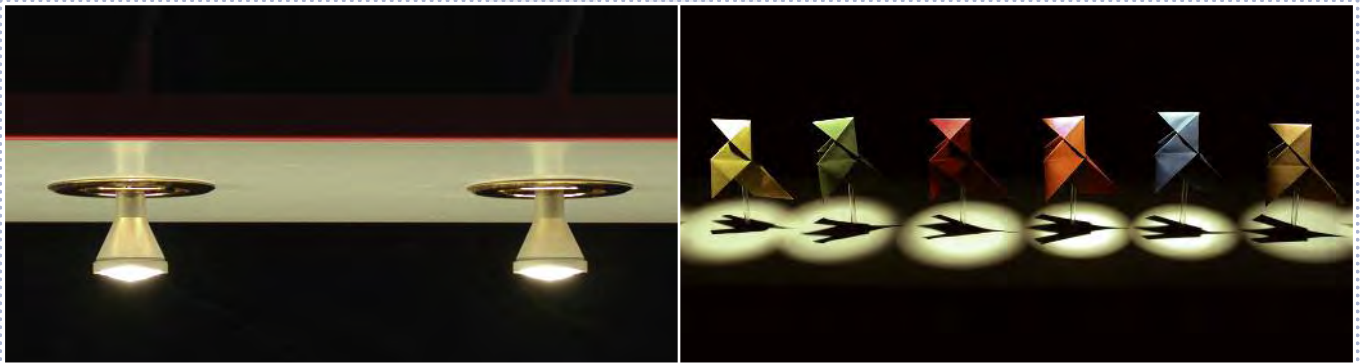

Adjustable Display Fittings | Apliques Orientables Interiores



Range of light alloy fittings with different lens configurations for showcases and other applications requiring spotlighting. Natural finish. Other finishes available on request.

Gama de apliques en aleación ligera con diferentes configuraciones ópticas para vitrinas y otras aplicaciones que requieran iluminación puntual. Acabado natural. Otros acabados disponibles bajo pedido.

CODE	PRODUCT	MATERIAL	FIT	FIBER Ø	OUTER Ø	LENS
ADF421	Adjustable display fitting	Polymer	Spring	3 / 5mm	50mm	30° / 50°
ADF431	Adjustable display fitting	Polymer	Spring	3 / 5mm	50mm	25° / 45°
ADF432	Adjustable display fitting	Light alloy	Spring	3 / 5mm	50mm	25° / 45°
ADF441	Adjustable display fitting	Light alloy	Spring	3 / 5mm	38mm	15° / 30°
ADF442	Adjustable display fitting	Light alloy	Spring	3 / 5mm	38mm	15° / 30°

Standard finishes: black, white, chrome, stainless steel.

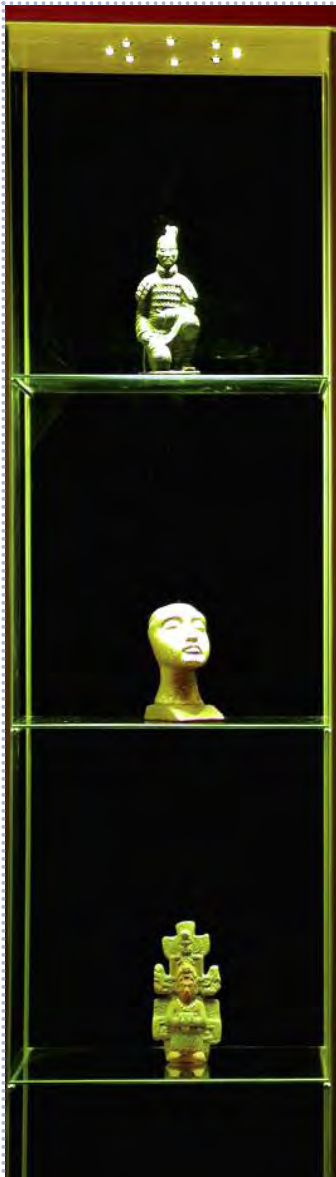

Adjustable & Downlight Display Fittings | Apliques Orientables y Fijos Interiores



Downlight and adjustable light alloy fittings for installation of profiles or thin panels with rear access in display cases and other applications requiring spotlighting.

Apliques orientables y fijos en aleación ligera para su instalación en perfiles y paramentos delgados en vitrinas y otras aplicaciones que requieran iluminación puntual. Acabado natural.

CODE	PRODUCT	MATERIAL	FIT	FIBER Ø	OUTER Ø	FINISH
ADF601	Adjustable display fitting	Light alloy	Spring	3 / 8mm	90mm	Matt anodized
ADF701	Downlight display fitting / frosted glass	Light alloy	Spring	3 / 8mm	73mm	Matt anodized





Range of light fixtures in light alloy up to 3,000mm long (L) and widths (W) from 100 to 600mm. For applications requiring light without heat or radiation in museums, control rooms or environments requiring special lighting. Customizable with the full range of Advanced fiber fittings.

Gama de luminarias en aleación ligera con dimensiones de hasta 3.000mm (L) y anchos (W) de hasta 600mm. Para aplicaciones que requieran luz sin calor o radiación, en museos, salas de control y entornos que requieran condiciones lumínicas especiales. Aceptan todos los apliques para fibra de Advanced.

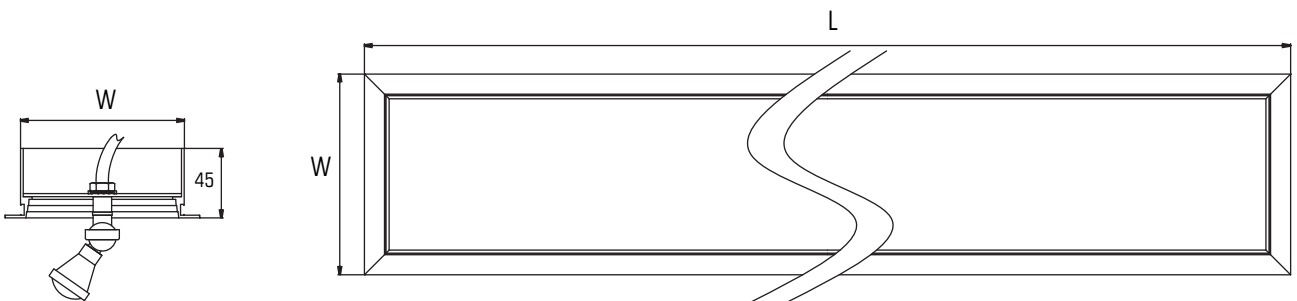

Custom Light Bars | Perfiles Luminosos a Medida



Range of light bars in light alloy up to 3,000mm long. For lighting applications without heat or radiation in museums, control rooms or environments requiring special lighting. Customizable with different fiber configurations and fittings.

Gama de perfiles en aleación ligera hasta 3.000mm. Para aplicaciones de iluminación sin calor o radiación, en museos, salas de control y entornos que requieran condiciones lumínicas especiales. Disponibles con diferentes configuraciones de fibra / apliques.

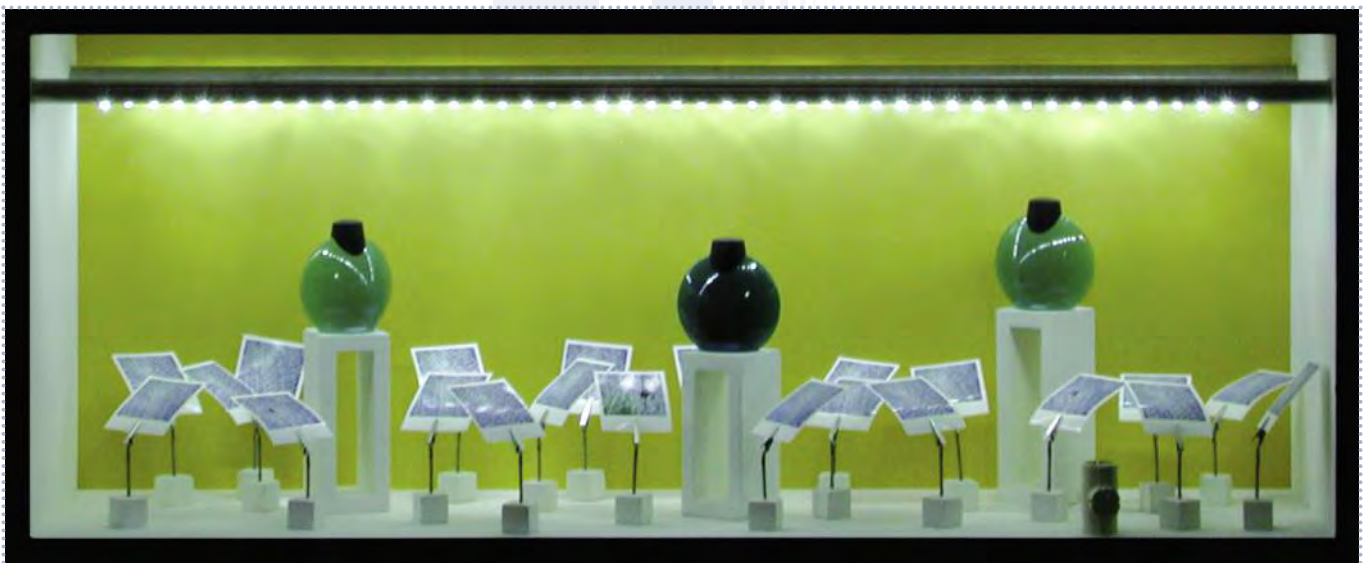
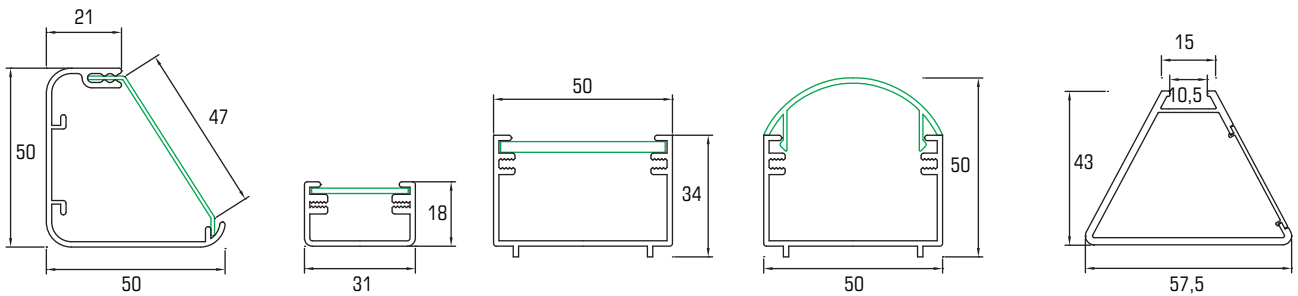

End Trims | Terminales Decorativos



Fittings for decoration and signage with different viewing angles. For fiber up to 2mm (FET100) and up to 1mm (FET200). Also, decorative trims (FET300 & 400), and textile mounting clips for attaching fibers to curtains and backdrops (TMC300 & 400).

Terminales para decoración y señalización, con diferentes ángulos de visionado. Para fibras de hasta 2mm (FET100) y hasta 1mm (FET200) con embellecedores (FET300 y 400), y clips para textiles, para incorporar fibras en cortinas y telones. (TMC300 y 400).

CODE	PRODUCT	Ø	FIBER Ø
FET101	Cylinder fiber end trim	8mm	Up to 2 mm
FET102	Fresnel fiber end trim	8mm	Up to 2 mm
FET103	Dome fiber end trim	8mm	Up to 2 mm
FET104	Cone fiber end trim	8mm	Up to 2 mm
FET105	Pyramid fiber end trim	8mm	Up to 2 mm
FET301	Chrome gasket	10mm	N/A
FET302	Gold plated gasket	10mm	N/A
TMC301	Textile clip	N/A	N/A

CODE	PRODUCT	Ø	FIBER Ø
FET201	Cylinder fiber end trim	4mm	Up to 1 mm
FET202	Fresnel fiber end trim	4mm	Up to 1 mm
FET203	Dome fiber end trim	4mm	Up to 1 mm
FET204	Cone fiber end trim	4mm	Up to 1 mm
FET205	Pyramid fiber end trim	4mm	Up to 1 mm
FET401	Chrome gasket	6mm	N/A
FET402	Gold plated gasket	6mm	N/A
TMC401	Textile clip	N/A	N/A

Decorative End Fittings | Terminales Decorativos



Fittings for signage and decoration. Available in either frosted or clear finish with a barbed fastener for blind hole installation or M10 screw fix for fitting in thin sheets or boards. Ø20mm.

Terminales para aplicaciones decorativas y señalización. Actúan como lentes para mejorar la visión. Disponibles en acabado transparente o matizado y con accesorios de montaje en cualquier paramento, incluso paneles y planchas finas. Ø20mm.

CODE	PRODUCT	FIX	FINISH
DEF101	30° lens end fitting	Barbed	Frosted
DEF201	Cylinder end fitting	Barbed	Frosted
DEF301	Cone end fitting	Barbed	Frosted
DEF401	Dome end fitting	Barbed	Frosted
DEF501	Pyramid end fitting	Barbed	Frosted
DEF102	30° lens end fitting	Barbed	Clear
DEF202	Cylinder end fitting	Barbed	Clear
DEF302	Cone end fitting	Barbed	Clear
DEF402	Dome end fitting	Barbed	Clear
DEF502	Pyramid end fitting	Barbed	Clear

CODE	PRODUCT	FIX	FINISH
DEF111	30° lens end fitting	Thread	Frosted
DEF211	Cylinder end fitting	Thread	Frosted
DEF311	Cone end fitting	Thread	Frosted
DEF411	Dome end fitting	Thread	Frosted
DEF511	Pyramid end fitting	Thread	Frosted
DEF112	30° lens end fitting	Thread	Clear
DEF212	Cylinder end fitting	Thread	Clear
DEF312	Cone end fitting	Thread	Clear
DEF412	Dome end fitting	Thread	Clear
DEF512	Pyramid end fitting	Thread	Clear

Cut Crystal Fittings | Terminales de Cristal



Cut crystals for decoration, to highlight a constellation, or simply for their beautiful reflections on the installation surface. Various suspension kits are available and need to be ordered separately.

Gama de terminales de cristal tallado, para decoración y potenciar efectos en cielos estrellados, etc. Disponemos de diferentes accesorios de montaje para ser pedidos aparte.

CODE	PRODUCT	FIBER Ø	FINISH	DIMENSIONS
CCF201	Button cut crystal fitting	3 / 6,5mm	Polished brass	Ø22mm x H 16mm
CCF203	Ball cut crystal fitting	3 / 6,5mm	Polished brass	Ø30mm x H 42mm
CCF208	Prism cut crystal fitting	3 / 6,5mm	Polished brass	Ø14mm x H 58mm
CCF210	Prism cut crystal fitting	3 / 6,5mm	Polished brass	Ø11mm x H 17mm
CCF214	Prism cut crystal fitting	3 / 6,5mm	Polished brass	Ø14mm x H 32mm

Also available custom crystals of any shape or size, with or without added security suspension systems for installation in public venues or to hold heavy crystals at great heights.



Cut Crystal Fittings | Terminales de Cristal



Cut crystals for decoration, starry skies, or simply for their beautiful reflections on the installation surface. Pressure fit in small-diameter holes.

Gama de terminales de cristal tallado, para decoración, cielos estrellados, o para proyectar reflejos en la superficie de instalación. Se instalan a presión en orificios practicados en el paramento.

CODE	PRODUCT	LIGHT GUIDE Ø	STANDARD FINISH	DIMENSIONS
CCF221	Prism cut crystal fitting	3mm	Chrome	Ø16mm x H 34mm
CCF222	Prism cut crystal fitting	3mm	Chrome	Ø16mm x H 30mm
CCF223	Prism cut crystal fitting	3mm	Chrome	Ø16mm x H 11mm
CCF224	Prism cut crystal fitting	3mm	Chrome	Ø16mm x H 15mm

Other finishes: gold and stainless steel. Mounting sleeves available on request.

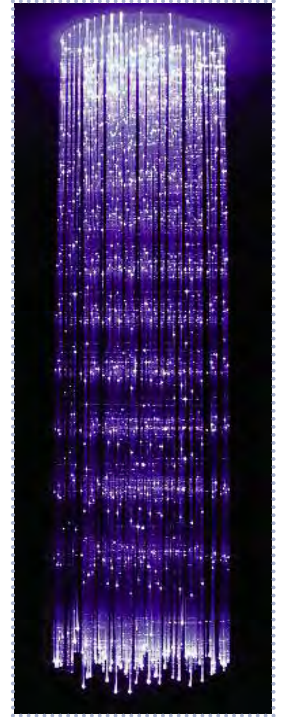

Range of fiber optics components for chandeliers and visual effects of any size and scope for horizontal and vertical surfaces and volumes. The range boasts all the components for the production of centrepieces, chandeliers, curtains, backdrops and decorative features with no limitations beyond the project design constraints.

The components of a chandelier are its base; (a surface with a pattern of drilled holes), the light guides of appropriate length; the illuminator(s) and the end pieces or trims at the end of the light guides.

Terminaciones de final de guía para una amplia gama de acabados. Disponibles para extremos de fibra rectos, conformables o desnudos. Otros modelos para la incorporación de cristales en hachones, arañas, cortinas, luminarias y construcciones luminosas de gran tamaño y/o de construcción especial.

Los componentes de un chandelier son su base (una superficie taladrada con el patrón de agujeros para colgar las guías), las guías ópticas de la longitud deseada, los iluminadores y las terminaciones de final de guía.



Light Guide Terminations | Terminaciones de Final de Guía

Light guide end terminations for an ample range of finishes. Suitable for bare, straight or conformable ends. Also terminations to attach decorative elements, such as crystals, glass or metal pieces or weights for chandeliers, curtains, center pieces, custom and large size light fixtures and backdrops. Light guides naturally curve at the end, due to the memory after being stored in a reel. Without a termination at the end of the guide, these won't hang straight.

Gama de componentes para luminarias modulares y efectos luminosos de cualquier tamaño y envergadura en paramentos y volúmenes horizontales y verticales. La colección comprende todos los componentes para la producción de hachones, arañas, cortinas, luminarias y elementos decorativos, sin más limitaciones que los parámetros de proyecto. Las guías ópticas se curvan en los extremos por la memoria, al haber sido almacenadas en bobinas. Sin terminación en su extremo, las guías no cuelgan rectas.

Terminations | Terminaciones



LGT100. Rigid end termination. This termination causes the fibers to hang without a curve on its end. Finished with an end lens or cap.

LGT100. Terminación rígida. Con esta terminación las guías de luz cuelgan sin curva en su extremo inferior. Acabado con lente final o capuchón.



LGT200. Conformable end termination. With this termination the light guide lower end can be shaped at will for decorative forms and patterns. Finished with an end lens or cap.

LGT200. Terminación conformable. Con esta terminación las guías de luz pueden ser conformadas a mano para conseguir efectos decorativos únicos. Acabado con lente final.



LGT300. Brass crimp end termination. This termination provides a rigid and solid element at the end of each light guide to attach crystals and other decorative elements. No end lens finish.

LGT300. Terminación con extremo de latón. Esta terminación rígida y sólida proporciona la férula de anclaje necesaria para la suspensión de elementos decorativos. Acabado sin lente final.



LGT400. FET lens end termination. This termination with a choice of organic lenses causes a sharp point of light on each single end while sealing the light guide.

LGT400. Terminación con lente FET. Esta terminación con varios modelos de lente orgánica proporciona un punto brillante en el extremo de la guía al tiempo que la sella.



LGT500. Sealed end caps. Crystal clear caps fused on the end of light guides to seal light guides and prevent the ingress of foreign matter and dirt. Can be combined with LGT100 and LGT200.

LGT500. Capuchones de terminación. Capuchones transparentes fusionados en el extremo de las guías para prevenir el ingreso de polvo y suciedad. Pueden combinarse con las terminaciones LGT100 y LGT200.

Microbraid™ - Sidelight Guides | Guías de Iluminación Lateral



Braided light guides for very large features and drops of up to 30m. A single MDI illuminator can power 60 of these light guides.

Guías tejidas para grandes estructuras y caídas de hasta 30m. Un iluminador MDI puede iluminar hasta 60 de estas guías.

CODE	DIAMETER	STRUCTURE	TYPE	ARCHITECTURE
HMG101	8mm	16 x 0,75mm	Microbraid™	N/A

On request, light guides can be produced to any diameter or architecture, such as stainless steel fire safety cables for up to 30Kg MBL or twin 0,75mm Cu cables to power LED or halogen capsules in their ends.

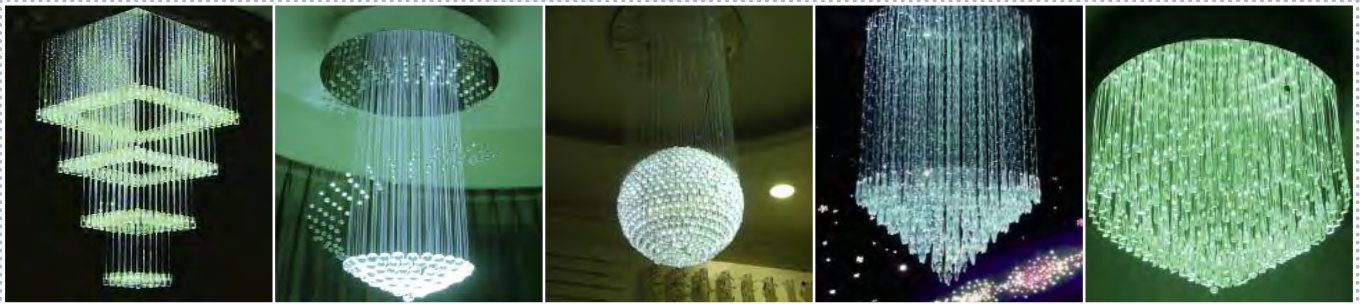

Untwisted Light Guides and Fibers | Guías y Fibras Laterales Lisas

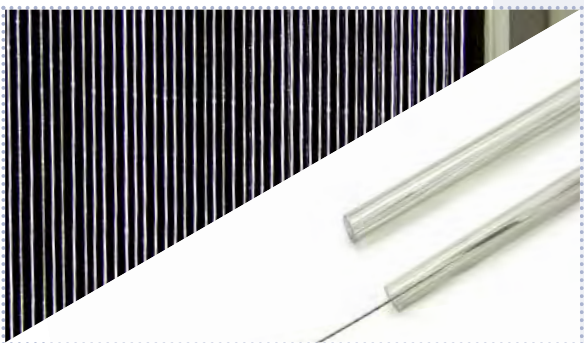

Straight (unbraided) light guides or fibers, for very long drops of up to 100m with reduced diameters. A single MDI illuminator can power from 70 to 600 of these light guides or fibers, depending on size.

Guías o fibras sin tejer para grandes caídas de hasta 100m. Un iluminador MDI puede iluminar desde 70 hasta 600 de estas guías o fibras, en función de su tamaño.

CODE	DIAMETER	STRUCTURE	TYPE
HSG301	5mm	14 x 0,75mm	Untwisted
HSG401	5mm	12 x 0,75mm	Untwisted
HSG501	4mm	7 x 0,75mm	Untwisted
HSG601	3mm	5 x 0,75mm	Untwisted
PSF101	2mm	1 x 1,00mm	Untwisted

On request, light guides or fibers can be produced to any diameter or architecture, such as stainless steel fire safety cables for up to 30Kg MBL.

Sparkle Sidelight Guides and Fibers | Guías y Fibras Destellantes



Sparkle light guides or fibers are the light conductors of choice for medium sized features up to 30m. A single MDI illuminator can power from 80 to 1,000 of these light guides and fibers, depending on size.

Las guías o fibras destellantes son el conductor de elección para estructuras medianas y caídas de hasta 30m. Un iluminador MDI puede iluminar desde 80 hasta 1.000 de estas guías o fibras, en función de su tamaño.

CODE	DIAMETER	STRUCTURE	TYPE
SSF103	Ø6,00mm	12 x 0,75mm	Sparkling
SSF101	Ø4,50mm	7 x 0,75mm	Sparkling
SSF102	Ø3,00mm	4 x 0,75mm	Sparkling
SSF201	Ø2,00mm	1 x 1,00mm	Sparkling
SSF222	Ø0,75mm	1 x 0,75mm	Sparkling
SSF221	Ø1,00mm	1 x 1,00mm	Sparkling

On request, light guides or fibers can be produced to any diameter or architecture, such as stainless steel fire safety cables for up to 30Kg MBL or twin 0,75mm Cu cables to power LED or halogen capsules in their ends.

Sparkle Glass Sidelight Guides | Guías Destellantes de Vidrio



Glass sparkle light guides for backdrops, curtains, small features, and drops of up to 10m. Not suitable for glass end pieces or other types of end termination. To avoid broken fibers from shaking loose, these light guides must be end capped.

Fibras de vidrio destellantes para cortinas, pequeños detalles y caídas hasta 10m. Estas guías no son adecuadas para soportar remates de vidrio ni aceptan diversas terminaciones. Para evitar que las fibras rotas se desplacen, los extremos de estas fibras deben ser selladas con un capuchón.

CODE	DIAMETER	STRUCTURE	TYPE
SGG201	2,5mm	150 glass FO	Sparkle
SGG301	2,5mm	200 glass FO	Sparkle

On request, these light guides can be produced to any diameter.

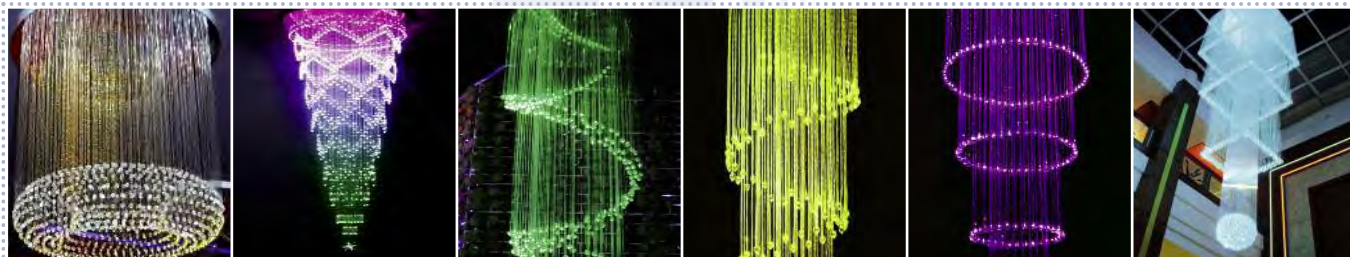



The addition of end pieces is a function of the overall design. On request we can supply standard cut crystal pieces, Swarovski™ crystals, hand made Murano pieces and custom produced metal, crystal or ceramic pieces. To support the pieces we offer a range of fasteners, with or without added security cables; gold or chrome plated or in 316 stainless steel for aggressive environments.

La incorporación de piezas finales es una función del diseño final. Bajo demanda podemos fabricar piezas en cristal tallado, cristales de Swarovski™ piezas artesanas de Murano, de metal o cerámicas. Disponemos de una amplia gama de elementos de sujeción y anclaje de los cristales, con o sin cables de seguridad, chapadas en oro, cromadas o en acero inoxidable 316 para ambientes agresivos.



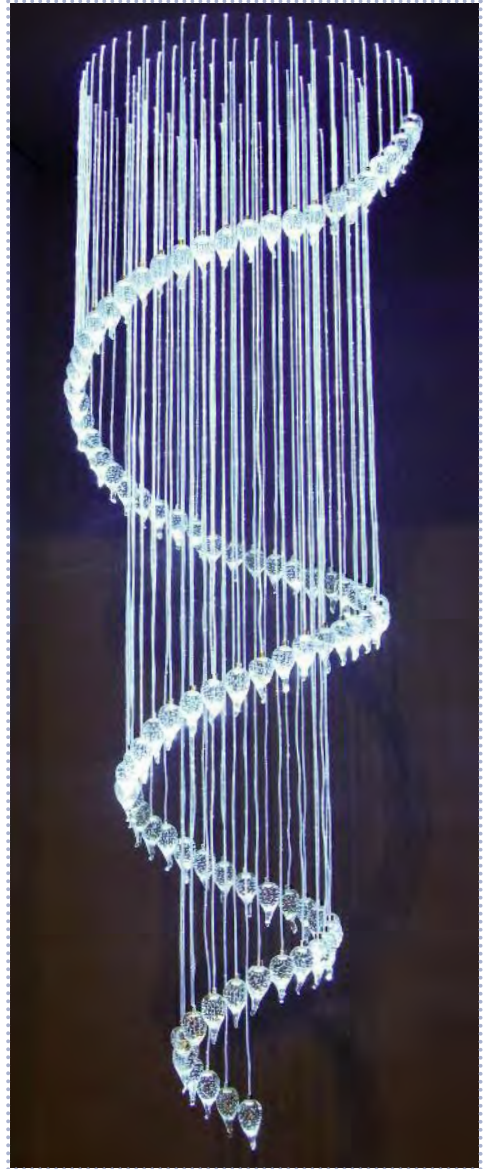

We supply chandeliers in components for any configuration of custom fixture with fiber optics or fully manufactured at our factory and delivered in ready-to-install units.

Suministramos los componentes de chandeliers para cualquier construcción con fibras ópticas o fabricamos luminarias listas para instalar.



Fiber Glass Pavers IP68 | Bloques de Vidrio para Fibra IP68



LFF104

Square glass pavers without maintenance for 3mm light guides. A single illuminator can power up to 90 units. IP68. With the correct illuminator these pavers can change color or be configured for RGB operation as a low cost alternative to LED.

Bloques de vidrio cuadrados, sin mantenimiento, para guía de 3mm. Un solo iluminador puede alimentar hasta 90 unidades. IP68. Con el iluminador adecuado estos bloques pueden cambiar de color o configurarse como RGB para una alternativa económica a los LED.

CODE	PRODUCT	FINISH	DIMENSIONS
LFF104	Fiber glass paver	Frosted / opal	L 100 x W 100 x H 70mm
LOP211	Installation / burial box in zinc-plated CRS	Natural	L 105 x W 105 x H 200mm
LOP212	Installation / burial box in AISI316 stainless steel	Natural	L 105 x W 105 x H 200mm

Custom finishes and configurations available on request.



Zinc plated installation boxes are not suitable for installation in wet areas, as they eventually rust. For outdoor installation we recommend AISI 316 stainless steel boxes.

Las cajas de instalación de chapa cincada no son adecuadas para zonas húmedas, ya que sufren oxidación. Para instalaciones en exteriores recomendamos las cajas en acero inoxidable AISI 316.

Fiber Glass Pavers IP68 | Bloques de Vidrio para Fibra IP68



LFF304

Small square glass pavers without maintenance for 3mm light guides. A single illuminator can power up to 90 units. IP68. With the correct illuminator these pavers can change color or be configured for RGB operation as a low cost alternative to LED.

Pequeños bloques de vidrio cuadrados, sin mantenimiento, para guía de 3mm. Un solo iluminador puede alimentar hasta 90 unidades. IP68. Con el iluminador adecuado estos bloques pueden cambiar de color o configurarse como RGB para una alternativa económica a los LED.

CODE	PRODUCT	FINISH	DIMENSIONS
LFF304	Fiber glass paver	Frosted / opal	L 60 x W 60 x H 60mm
LOP231	Installation / burial box in zinc-plated CRS	Natural	L 65 x W 65 x H 120mm
LOP232	Installation / burial box in AISI316 stainless steel	Natural	L 65 x W 65 x H 120mm

Custom finishes and configurations available on request.

Fiber Glass Pavers IP68 | Bloques de Vidrio para Fibra IP68



LFF204

Round glass pavers without maintenance for 3mm light guides. A single illuminator can power up to 90 units. IP68. With the correct illuminator these pavers can change color or be configured for RGB operation as a low cost alternative to LED.

Bloques de vidrio redondos, sin mantenimiento, para guía de 3mm. Un solo iluminador puede alimentar hasta 90 unidades. IP68. Con el iluminador adecuado estos bloques pueden cambiar de color o configurarse como RGB para una alternativa económica a los LED.

CODE	PRODUCT	FINISH	DIMENSIONS
LFF204	Fiber glass paver	Frosted / opal	Ø105 x H 70mm
LOP221	Installation / burial box in zinc-plated CRS	Natural	Ø110 x H 200mm
LOP222	Installation / burial box in AISI316 stainless steel	Natural	Ø110 x H 200mm

Custom finishes and configurations on request.

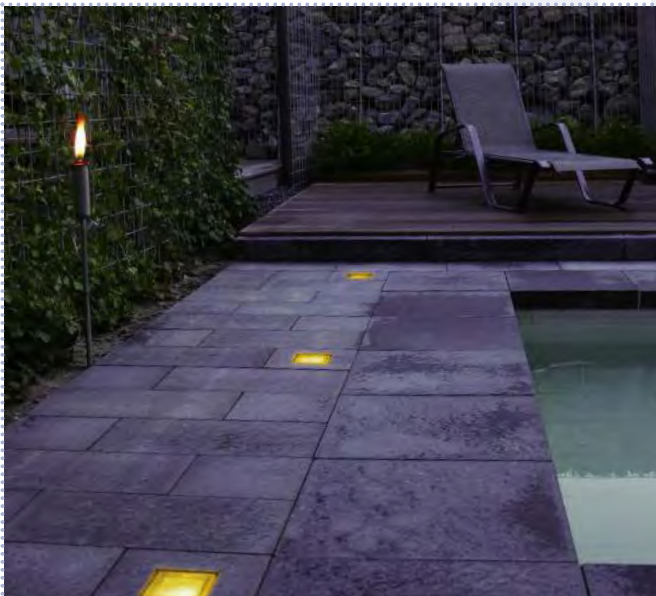

Waterproof Light Fittings IP68 | Apliques Estancos IP68



WLF710 SERIES



WLF750 SERIES

Discrete fiber optic fittings with IP68 rating. Externally threaded and supplied with nuts and gaskets. Manufactured from AISI 316 stainless steel. Model to be ordered according to fiber diameters.

Apliques con protección IP68, y suministrados con juntas y roscas. Fabricados en acero inoxidable AISI 316. Diferentes referencias según fibra a utilizar.

CODE	PRODUCT	FIBER Ø	OUTER Ø	MATERIAL
WLF711	Waterproof light fitting	1,00mm	25mm	Stainless steel
WLF712	Waterproof light fitting	2,00mm	25mm	Stainless steel
WLF713	Waterproof light fitting	3,00mm	25mm	Stainless steel
WLF751	Waterproof light fitting	5,00mm	45mm	Stainless steel
WLF752	Waterproof light fitting	6,50mm	45mm	Stainless steel
WLF753	Waterproof light fitting	8,00mm	45mm	Stainless steel

These fittings are suitable for underwater installation in pools and fountains.



Miniature Waterproof Light Fittings | Apliques Estancos Miniatura



Miniature fittings for step, deck, corridors, staircases, and star ceilings in floors, saunas, pools and other wet locations.

Apliques miniatura para pasillos, porches, peldaños y cielos estrellados en suelos, saunas, piscinas y otros espacios húmedos.

CODE	PRODUCT	FIBER Ø	OUTER Ø	MATERIAL
WLF901	Miniature waterproof light fitting	1 / 1,5mm	12mm	Stainless steel
WLF902	Miniature waterproof light fitting	1,5 / 2mm	20mm	Stainless steel
WLF910	Miniature waterproof light fitting	1 / 6,5mm	16mm	Stainless steel

Waterproof Light Fittings IP68 | Apliques Estancos IP68



For fountains, pools, waterworks, jets and other wet-locations. ODF500 series, manufactured of marine grade AISI 316 stainless steel and to IP68 standards. Includes mounting bracket.

Gama para fuentes, piscinas, juegos de aguas, surtidores y zonas húmedas. Fabricados en acero inoxidable grado marino AISI 316 y estancos IP68. Incluyen soporte.

CODE	PRODUCT	LENS TYPE	FIBER Ø	OUTER Ø
ODF501	Outdoor directional fitting	17° fresnel	5,00mm	43mm
ODF511	Outdoor directional fitting	48° mineral	5,00mm	43mm
ODF502	Outdoor directional fitting	17° fresnel	6,50mm	43mm
ODF512	Outdoor directional fitting	48° mineral	6,50mm	43mm
ODF503	Outdoor directional fitting	17° fresnel	8,00mm	43mm
ODF513	Outdoor directional fitting	48° mineral	8,00mm	43mm

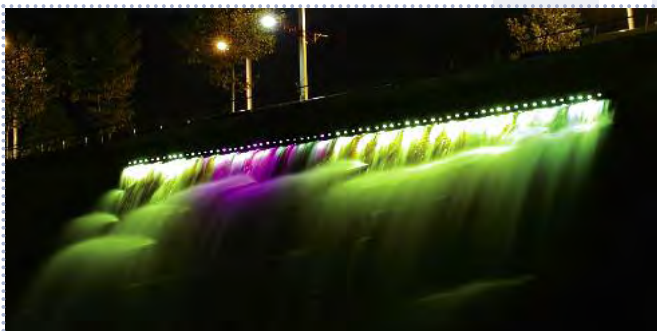

Waterproof Light Fittings | Apliques Estancos



WLF451/461



WLF452/462

Fittings with round or square top for in-ground installation, with or without a 30° lens. Light alloy body with stainless steel cover and PVC. Installation box included. IP67.

Apliques para empotrar en suelos y paramentos, con embellecedor en acero inoxidable redondo o cuadrado. Con o sin lente ajustable de 30°. Cuerpo en aleación ligera y caja de montaje en PVC. IP67.

CODE	PRODUCT	TOP PLATE DIMENSIONS	MATERIAL
WLF451	Waterproof light fitting 60°. Adjustable. Round trim cover	Ø115mm	S. Steel / light alloy
WLF452	Waterproof light fitting 60°. Adjustable. Square trim cover	110mm x 110mm	S. Steel / light alloy
WLF461	Waterproof light fitting 30°. Adjustable. Round trim cover	Ø115mm	S. Steel / light alloy
WLF462	Waterproof light fitting 30°. Adjustable. Square trim cover	110mm x 110mm	S. Steel / light alloy

For in-ground installation these fixtures need drainage.



Waterproof Light Fittings IP68 | Apliques Estancos IP68



WLF800 SERIES



WLF810 SERIES

ABS pool fittings in white and chrome finish. Choice of spot or flood lenses included. Different versions available according to type of pool and installation method. IP68.

Gama de apliques de piscina en ABS, con acabado blanco o cromado. Incluyen lentes intensivas y extensivas. Diferentes versiones según tipo de piscina y modo de instalación. IP68.

CODE	PRODUCT	OUTER Ø	MATERIAL
WLF801	Waterproof light fittings for concrete pools. Threaded	118mm	White ABS
WLF802	Waterproof light fittings for concrete pools. Unthreaded	118mm	White ABS
WLF803	Waterproof light fittings for liner pools	118mm	White ABS
WLF804	Waterproof light fittings for fiberglass & plastic pools	118mm	White ABS
WLF811	Waterproof light fittings for concrete pools. Threaded	118mm	Chromed ABS
WLF812	Waterproof light fittings for concrete pools. Unthreaded	118mm	Chromed ABS
WLF813	Waterproof light fittings for liner pools	118mm	Chromed ABS
WLF814	Waterproof light fittings for fiberglass & plastic pools	118mm	Chromed ABS

Waterproof Light Fittings IP68 | Apliques Estancos IP68



WLF761



WLF762

Waterproof fitting for installation in floors, walls or underwater, in 316 stainless steel. Snug fitting with o-rings in standard Ø40mm PVC tubes. IP68. Suitable for 3mm light guides. A Standard MHI or MDI illuminator can power up to 90 fittings.

Aplique estanco para instalación en suelos, paredes o sumergido, en acero inoxidable 316. Colocación a presión con juntas tóricas en tubos de PVC de Ø40mm. IP68. Para guías de 3mm. Un iluminador estándar, MHI o MDI puede alimentar hasta 90 unidades.

CODE	PRODUCT	FIBER Ø	OUTER DIMENSIONS	MATERIAL
WLF761	Waterproof light fitting. Round trim cover	3mm	Ø45mm	Stainless steel
WLP762	Waterproof light fitting. Square trim cover	3mm	45 x 45mm	Stainless steel

Other finishes and configurations available on request.

Waterproof Adjustable Fitting IP68 | Aplique Estanco Orientable IP68



WLF770



WLF780

Adjustable fittings for step, deck, corridors, staircases, saunas, pools and other wet locations. Manufactured off AISI 316 marine grade stainless steel. IP68.

Apliques orientables para pasillos, porches, suelos, saunas, piscinas y otros espacios húmedos. Fabricados en acero inoxidable AISI 316. IP68.

CODE	PRODUCT	LENS TYPE	FIBER Ø	OUTER Ø
WLF770	Waterproof adjustable fitting	20 / 40°	2 / 6,5mm	75mm
WLF780	Waterproof adjustable fitting	20 / 40°	2 / 3mm	52mm

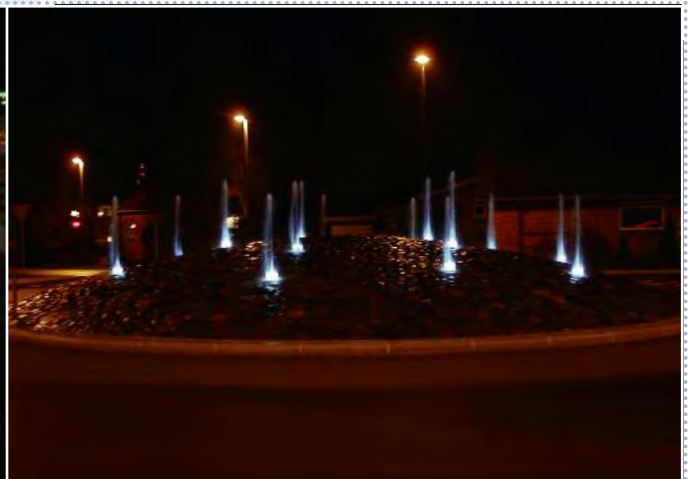

Outdoor Light Pavers | Apliques Exteriores



WLF470



WLF480

Outdoor fittings in stainless steel, for installation on floors and walls. A standard MHI or MDI illuminator can power up to 90 fittings.

Aplique exteriores en acero inoxidable, para instalación en paramentos horizontales o verticales. Un iluminador estándar, MHI o MDI puede alimentar hasta 90 unidades.

CODE	PRODUCT	FIBER Ø	OUTER DIMENSIONS	MATERIAL
WLF470	Outdoor light paver. Round trim cover	3 / 6,5mm	Ø47mm	Stainless steel
WLF480	Outdoor light paver. Square trim cover	3 / 6,5mm	47 x 47mm	Stainless steel

Other finishes, sizes and configurations available on request.



Decorative Light Fittings | Apliques Decorativos



WLF763



WLF764

Decorative fitting for installation on floors and walls in wet or dry locations. Manufactured off light alloy. Snug fitting with rings in standard Ø40mm PVC tubes. Suitable for 3mm light guides. A standard MHI or MDI illuminator can power up to 90 fittings.

Aplique decorativo para instalación en suelos o paredes en interiores o exteriores. Fabricado en aleación ligera. Colocación a presión con juntas tóricas en tubos de PVC de Ø40mm. Para guías de 3mm. Un iluminador estándar, MHI o MDI puede alimentar hasta 90 unidades.

CODE	PRODUCT	FIBER Ø	OUTER DIMENSIONS	MATERIAL
WLF763	Waterproof light fitting. Round trim cover	3mm	Ø45mm	Light alloy
WLP764	Waterproof light fitting. Square trim cover	3mm	45 x 45mm	Light alloy

Other finishes and configurations available on request.



Waterproof Light Fittings | Apliques Estancos



WLF321



WLF511

WLF321 and WLF511 fittings for step, corridor, and staircase lighting in saunas, outdoors and other wet locations. Manufactured off light alloy or stainless steel.

Apliques WLF321 y WLF511 para pasillos y peldaños en saunas, exteriores y otros espacios húmedos. Fabricados en aleación ligera o acero inoxidable.

CODE	PRODUCT	FIBER Ø	OUTER Ø	MATERIAL
WLF321	Waterproof light fitting with 30° asymmetrical lens	3 / 8mm	37mm	Light alloy
WLF511	Waterproof light fitting with 30° lens	3 / 6,5mm	37mm	Stainless steel

Waterfalls | Cascadas



No fiber optic pool is complete without the waterfall fittings. The fiber illuminates the water pumped through the unit from the back, to boast an impressive sheet of colored water: Easy to install. from 300 to 2,400mm.

Ninguna piscina está completa sin las cascadas de agua. Permiten obtener el efecto espectacular de una lámina de agua iluminada. Fácil de instalar. Tamaños disponibles entre 300 y 2.400mm.

SERIES	PRODUCT	WIDTH	SPOUT
OAF	Oasis Arch Falls	From 304,8mm to 1219,2mm	From 25,4mm to 304,8mm
OCF	Oasis Curtain Falls	From 304,8mm to 1219,2mm	From 152,4mm to 304,8mm
ONF	Oasis Curtain Falls	From 304,8mm to 2438,4mm	228,6mm
ORF	Oasis Rainforest Falls	From 304,8mm to 2438,4mm	From 25,4mm to 304,8mm
OSR	Oasis Starlight Rainforest	From 304,8mm to 2438,4mm	228,6mm
OSW	Oasis Standar Waterfalls	From 304,8mm to 2438,4mm	From 25,4mm to 304,8mm

Waterfall fittings are custom made, in any size up to 2400mm and can be shaped to curved surfaces.

Please allow from 8 to 12-week delivery.



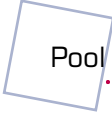

Pool Starry Skies Installation Details | Detalles de Instalación de Firmamentos en Piscinas



Techniques and products for the installation of starry skies and special effects in water environments, backed by hundreds of successful installations in five continents.

Técnicas y productos para la instalación de firmamentos y efectos especiales en entornos subacuáticos, avalados por cientos de instalaciones en cinco continentes.

CODE	PRODUCT	OUTER Ø	PACKING
HCF201	High performance clad fiber 1,00mm. Polyolefine HFFR cladding	3mm	1000m
HCF301	High performance clad fiber 1,50mm. Polyolefine HFFR cladding	3,5mm	500m
UFF401	AISI 316 stainless steel fiber support	N/A	N/A

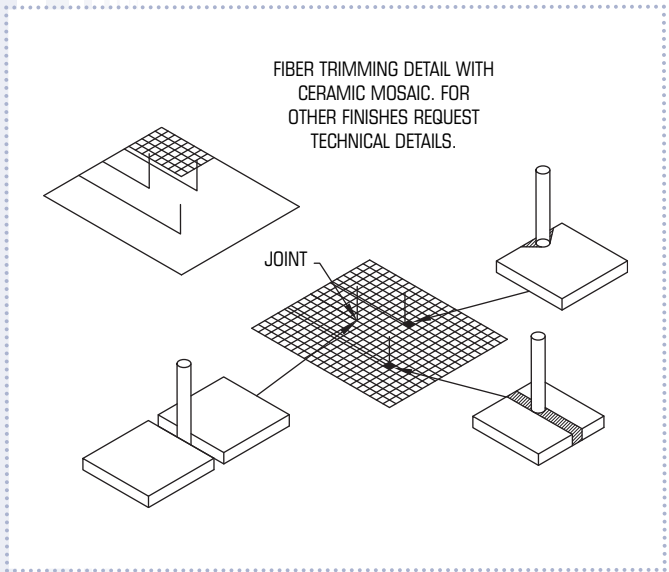
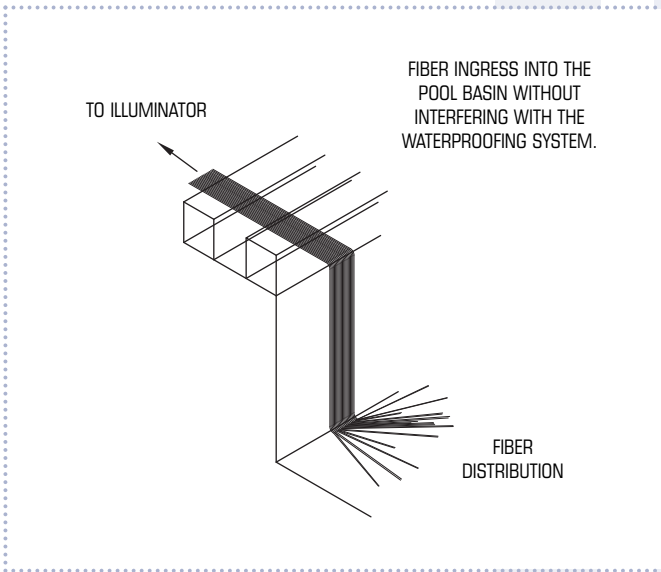
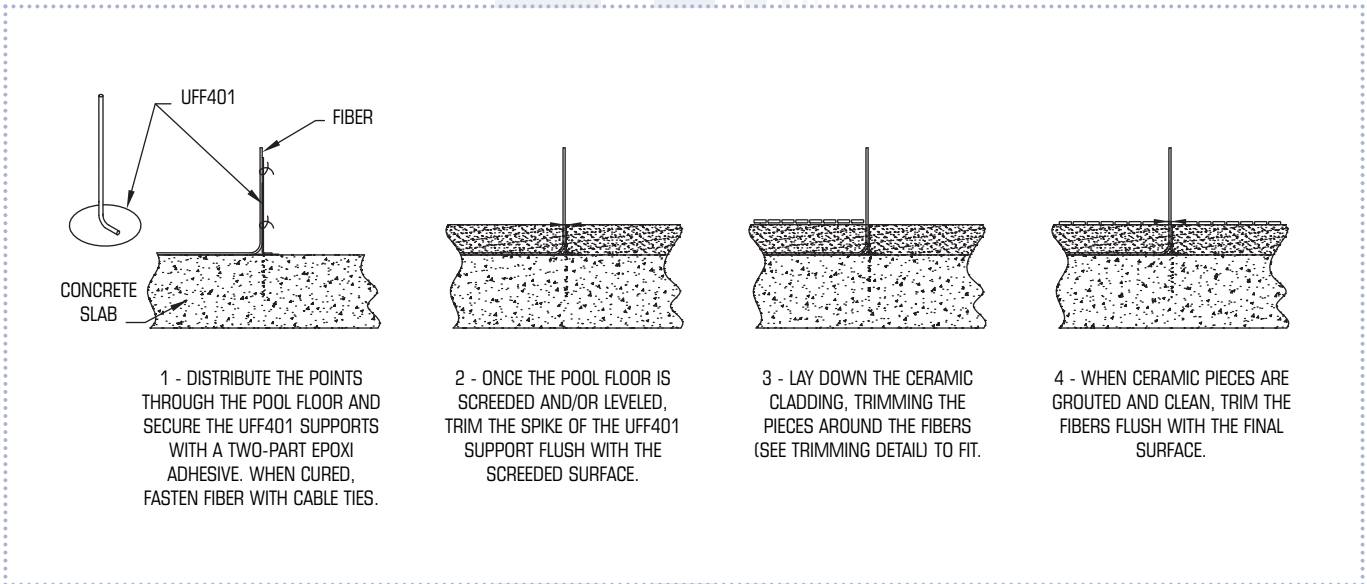



Starry skies have become the highest expression of sophisticated lighting in pools, both indoor and outdoor. Swimming or using a pool with a starry sky at night it's an unforgettable experience. Full preparation and installation details available from our technical department.





Los firmamentos se han convertido en la máxima expresión de iluminación sofisticada para piscinas, tanto exteriores como interiores.
El uso nocturno de una piscina dotada de este sistema es una experiencia inolvidable.
Nuestro departamento técnico dispone de extensas instrucciones para la preparación e instalación de estos sistemas.



Advanced has pioneered this exciting new fashionable trend and developed special light conductors and accessories to facilitate the installation of starry skies in pools. Sideral effects such as shooting stars, nebulas, comets and scores of custom motives and underwater effects are custom produced with special polymer templates manufactured on request.

Advanced es pionera en el desarrollo de conductores ópticos y accesorios especiales para facilitar la integración de firmamentos en piscinas. Efectos siderales, tales como estrellas fugaces, nebulosas, cometas y muchos otros motivos y efectos se fabrican a medida con plantillas de polímero fabricados bajo pedido.



Advanced is the foremost World manufacturer of ready-made sets of elements and patterns to incorporate in starry skies and other decorative installations. In addition, we can custom produce any effect, sign, feature or pattern in any size. All sets are furnished complete with ready-made and coded animation harnesses, special illuminators built to reproduce a given sequence or movement and templates for drilling the pattern onto its base. On request, we can manufacture ready made effects on panels made from any construction material; gypsum board, plywood, metal or polymer, professionally finish to integrate in any scheme.

Advanced es el mayor productor mundial de kits para su incorporación en firmamentos y otros elementos decorativos, escenas y patrones. Fabricamos a medida cualquier rótulo, efecto, patrón o escena a cualquier tamaño. Todos nuestros kits se suministran completos con mazos de animación codificados, iluminadores especiales construidos para reproducir una secuencia o efecto determinado y plantillas de taladrado para trasladar el patrón a la superficie de instalación. Bajo pedido, fabricamos efectos terminados en cualquier panel de construcción; cartón yeso, contraplacado, metálico o de polímero, con acabados profesionales y listos para incorporar en cualquier entorno.





Starry sky effect sets to cover different areas. Complete with illuminator, fiber harness and instructions. We can design and supply starry skies of any size and complexity, such as the new Amiri Air Terminal with 10,000m² over 2,000Km of fibers, 500,000 points and more than 400 illuminators.

Kits de firmamentos para cubrir áreas de diversa extensión, con iluminador, mazo de fibras e instrucciones. Podemos fabricar y suministrar firmamentos de cualquier tamaño y complejidad, como la Terminal Amiri, con 10.000m², 2.000Km de fibras, 500.000 puntos y más de 400 iluminadores.

CODE	PRODUCT	FIBERS	FIBER Ø	LENGTH	AREA	ILLUMINATOR
CES851	Starry sky kit	200	Mixed	2m	4m ²	ASI*
CES852	Starry sky kit	300	Mixed	2 / 3m	6m ²	ASI*
CES853	Starry sky kit	400	Mixed	2 / 3m	8m ²	ASI*
CES854	Starry sky kit	450	Mixed	2 / 3 / 4m	9m ²	ASI*

On request we can manufacture these patterns or any other from a drawing or photograph.

* Noiseless (no fan).



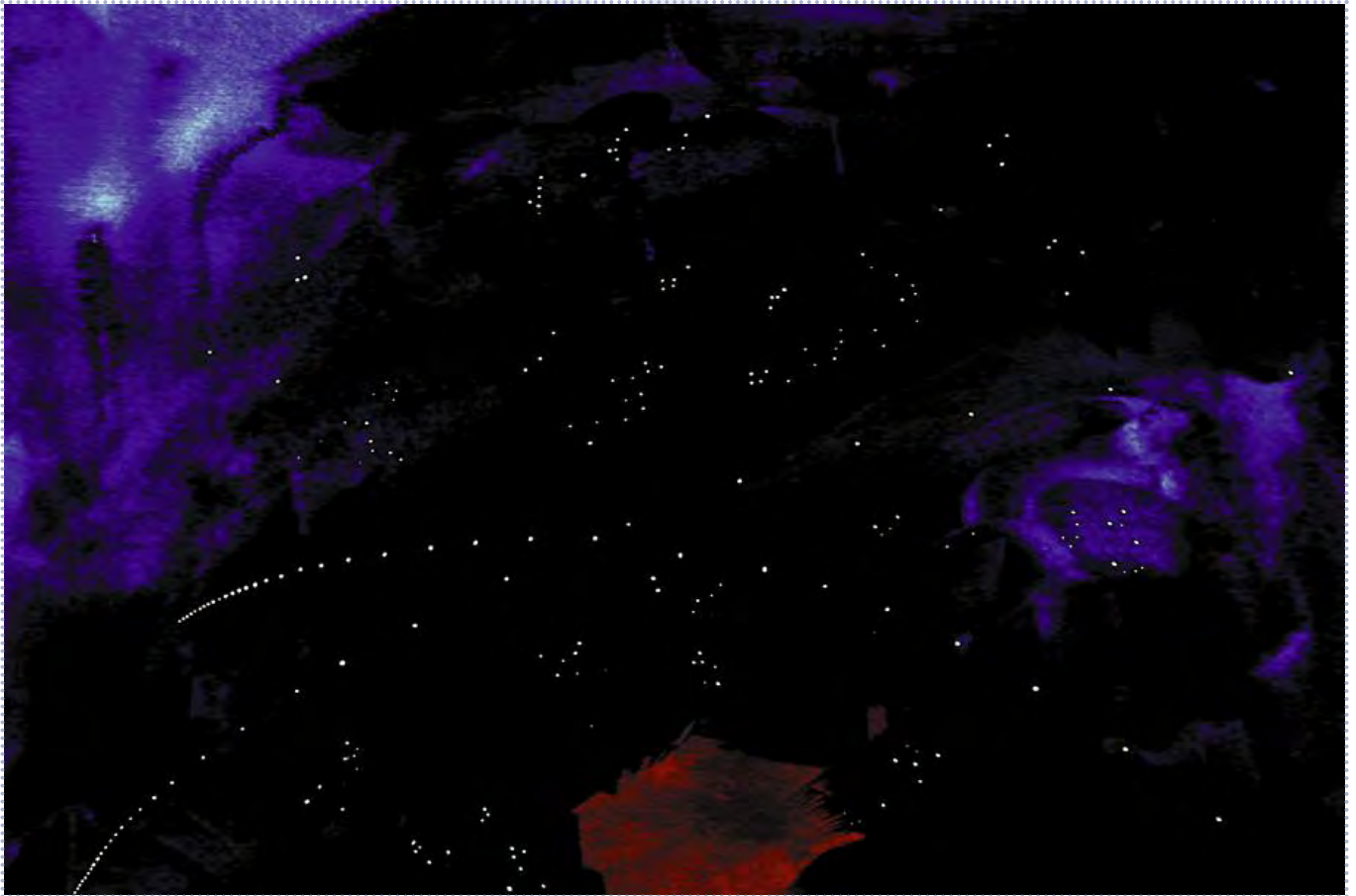

Shooting star and starry sky effect sets with illuminator, fiber harness and instructions.

Kits de estrellas fugaces y firmamentos con iluminador, mazo de fibras e instrucciones.

CODE	PRODUCT	FIBERS	FIBER Ø	LENGTH	ILLUMINATOR
CES103	Shooting star + starry sky kit	112 + 200	Mixed	3m	AHI**
CES104	Shooting star + starry sky kit	112 + 450	Mixed	4m	AHI**
CES152	Shooting star + starry sky kit	76 + 200	Mixed	2m	ASI*

On request we can manufacture these patterns or any other from a drawing or photograph.

* Noiseless (no fan). ** Available with low-noise fan.

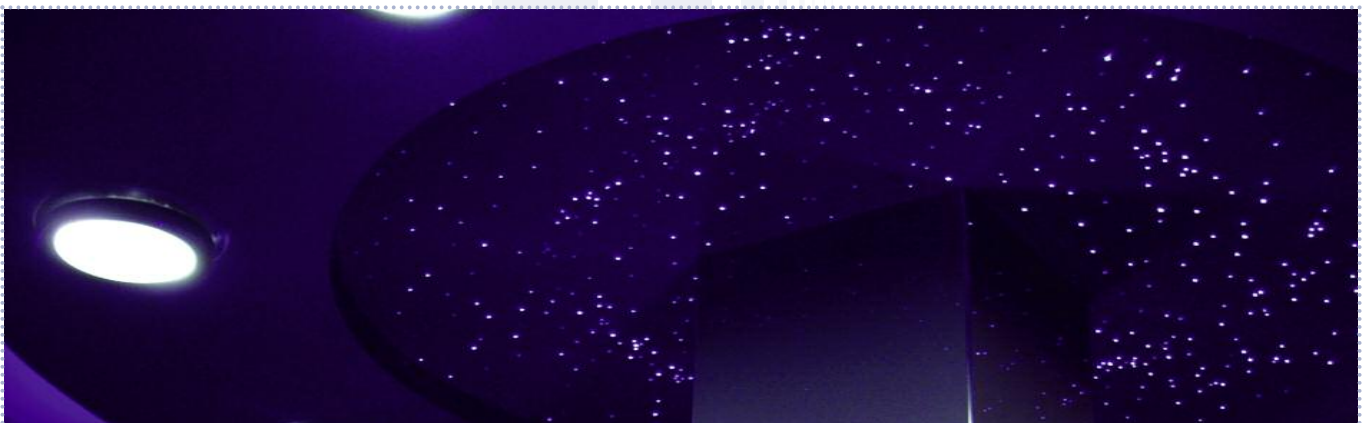

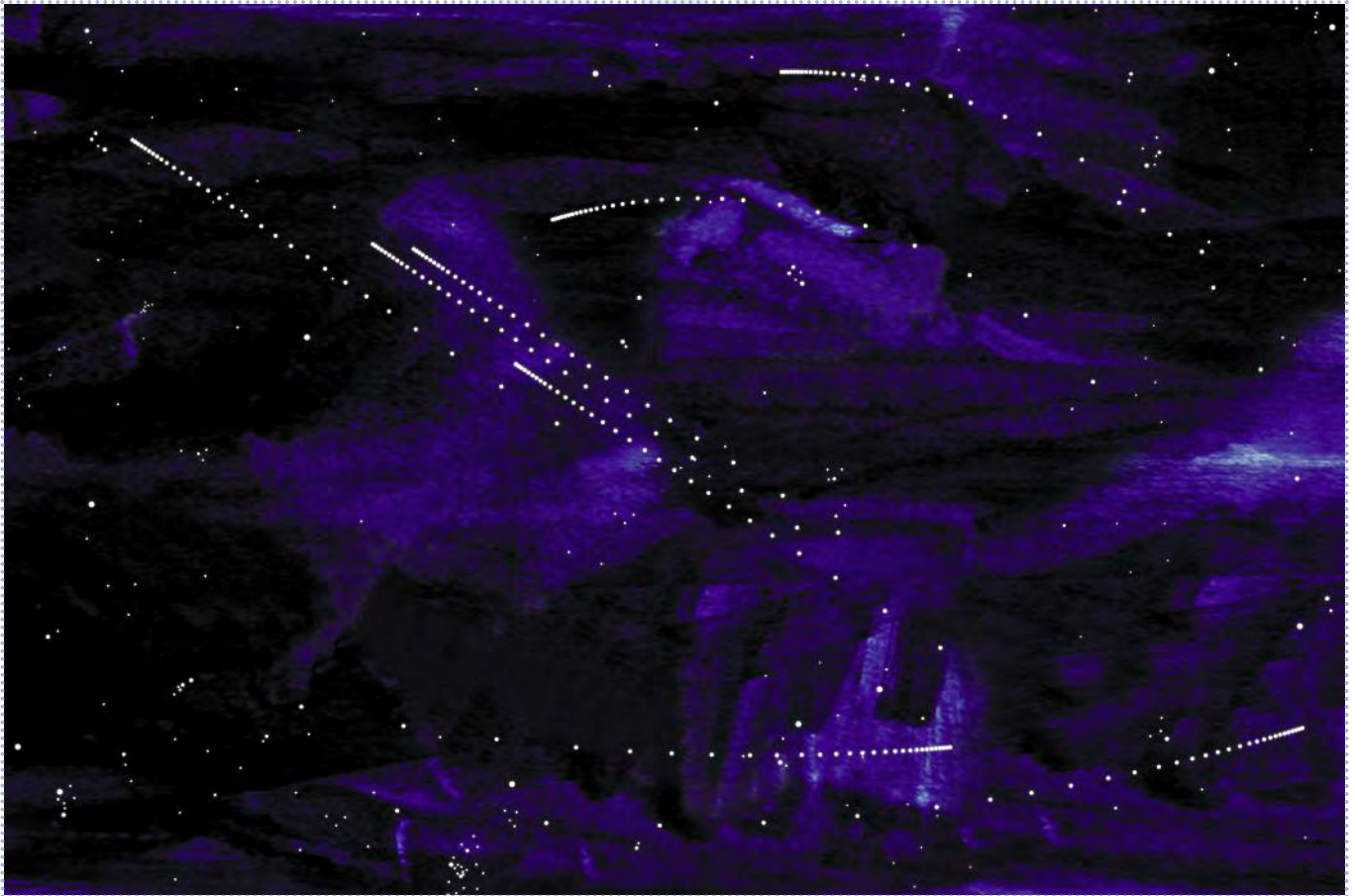

Shooting star effect kit with illuminator, fiber harness, 1:1 drilling template and instructions.

Kits de estrellas fugaces con iluminador, mazo de fibras, plantilla de taladrado 1:1 e instrucciones.

CODE	PRODUCT	FIBERS	FIBER Ø	LENGTH	ILLUMINATOR
CES101	Shooting star kit	56	1,00mm	2m	AHI**
CES102	Shooting star kit	112	1,00mm	3m	AHI**
CES151	Shooting star kit	76	0,50mm	2m	ASI*

On request we can manufacture these patterns or any other from a drawing or photograph.

* Noiseless (no fan). ** Available with low-noise fan.

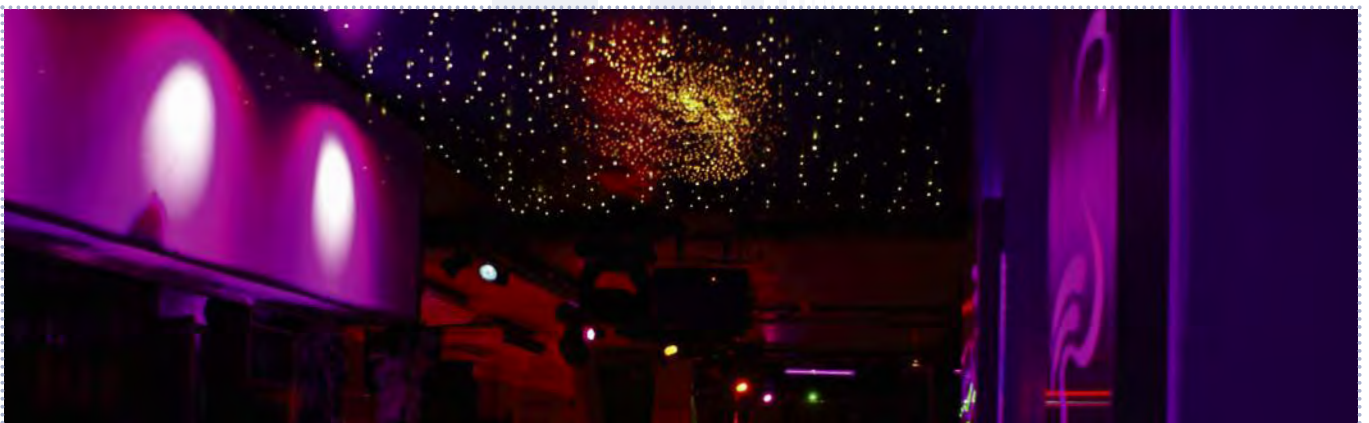

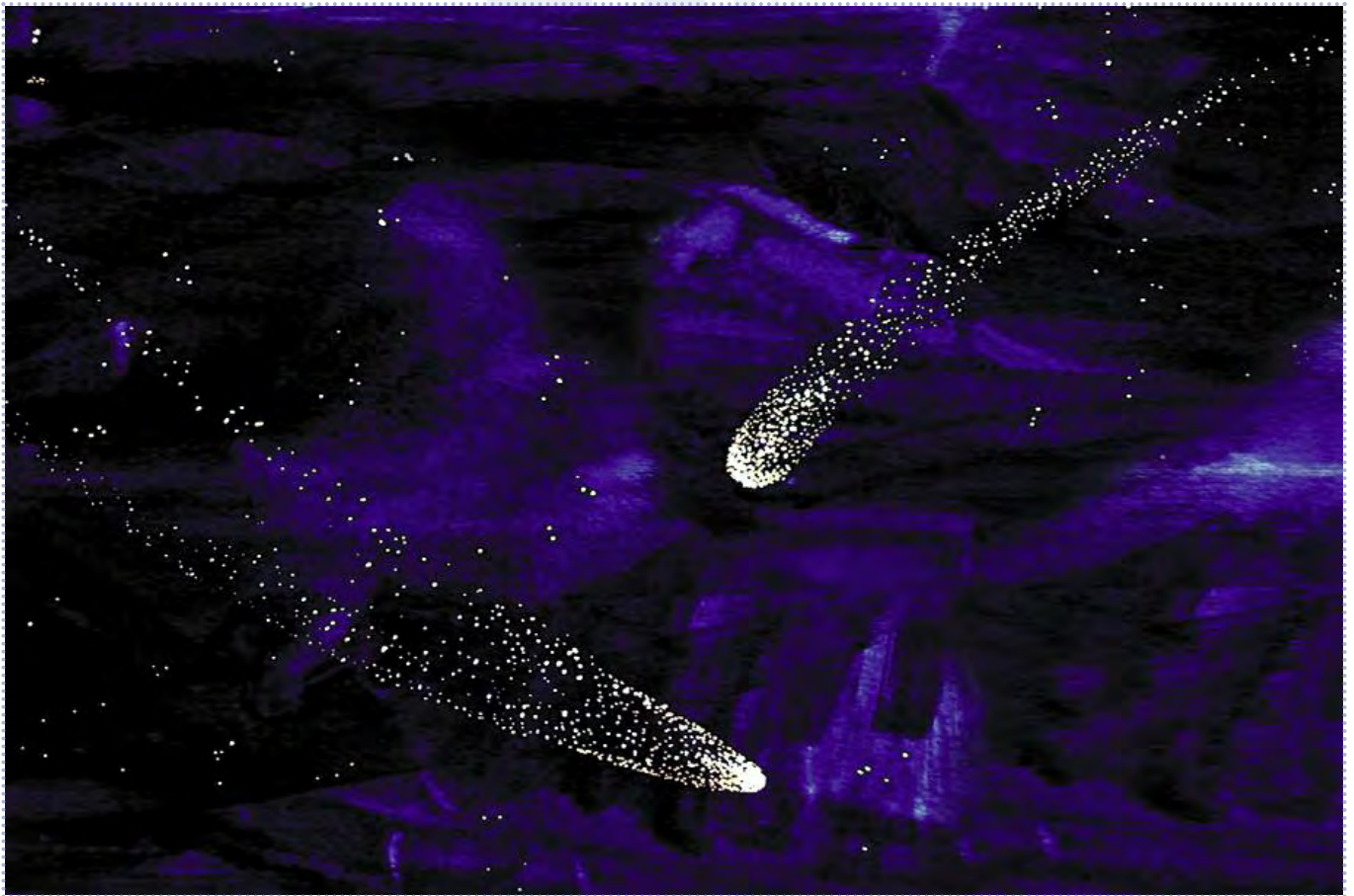

Open or closed comet effect sets. Complete with illuminator, fiber harness, scale 1:1 drilling template and installation instructions.
 Kit de cometa abierto o cerrado, completo con iluminador, mazo de fibras, plantilla de taladrado 1:1 e instrucciones.

CODE	PRODUCT	FIBERS	FIBER Ø	LENGTH	ILLUMINATOR
CES201	Open comet kit	750	0,50mm	2m	AHI**
CES202	Open comet kit	1500	0,50mm	2m	AHI**
CES203	Closed comet kit	750	0,50mm	2m	AHI**
CES204	Closed comet kit	1500	0,50mm	2m	AHI**
CES251	Open comet kit	648	0,50mm	2m	ASI*
CES252	Closed comet kit	648	0,50mm	2m	ASI*

On request we can manufacture these patterns or any other from a drawing or photograph.

* Noiseless (no fan). ** Available with low-noise fan.



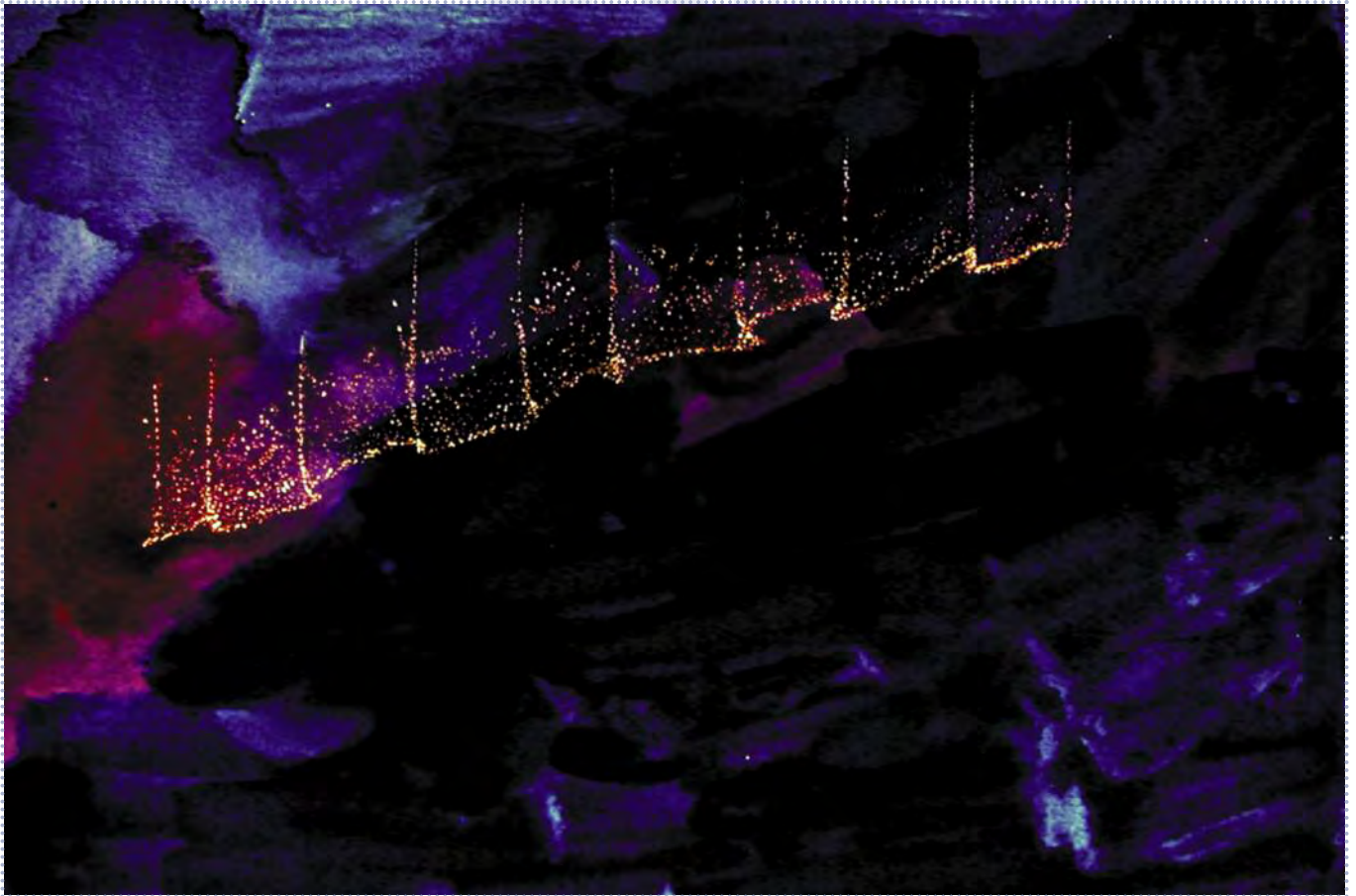

Aurora kits complete with illuminator, fiber harness, scale 1:1 drilling template and instructions.

Kits de aurora con iluminador, mazo de fibras, plantilla de taladrado a escala 1:1 e instrucciones de montaje.

CODE	PRODUCT	FIBERS	FIBER Ø	LENGTH	ILLUMINATOR
CES301	Aurora short kit	1800	0,50mm	2m	AHI**
CES302	Aurora long kit	3600	0,50mm	2m	AHI**

On request we can manufacture these patterns or any other from a drawing or photograph.

** Available with low-noise fan.

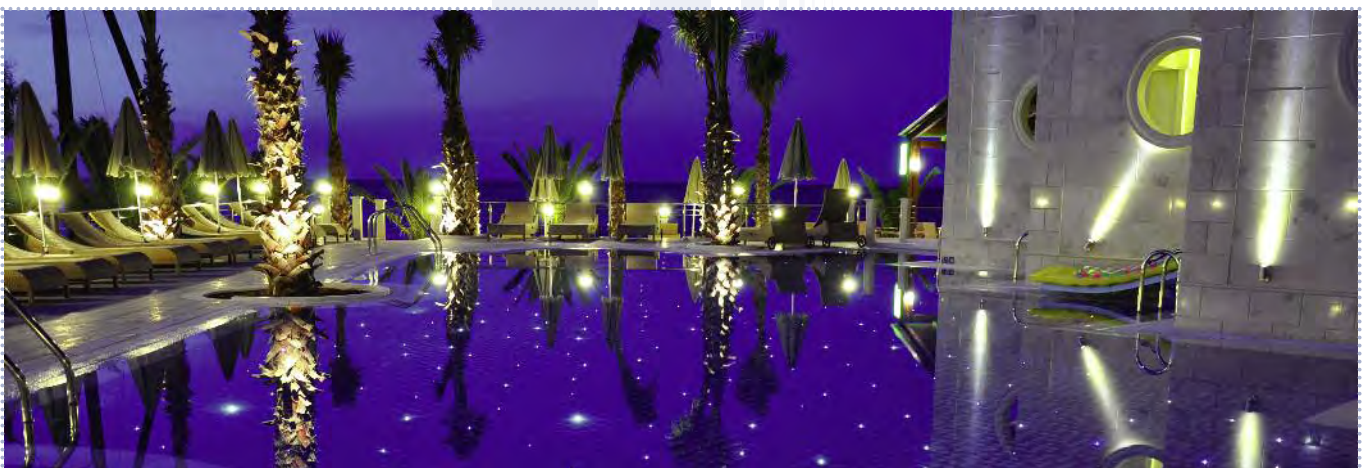

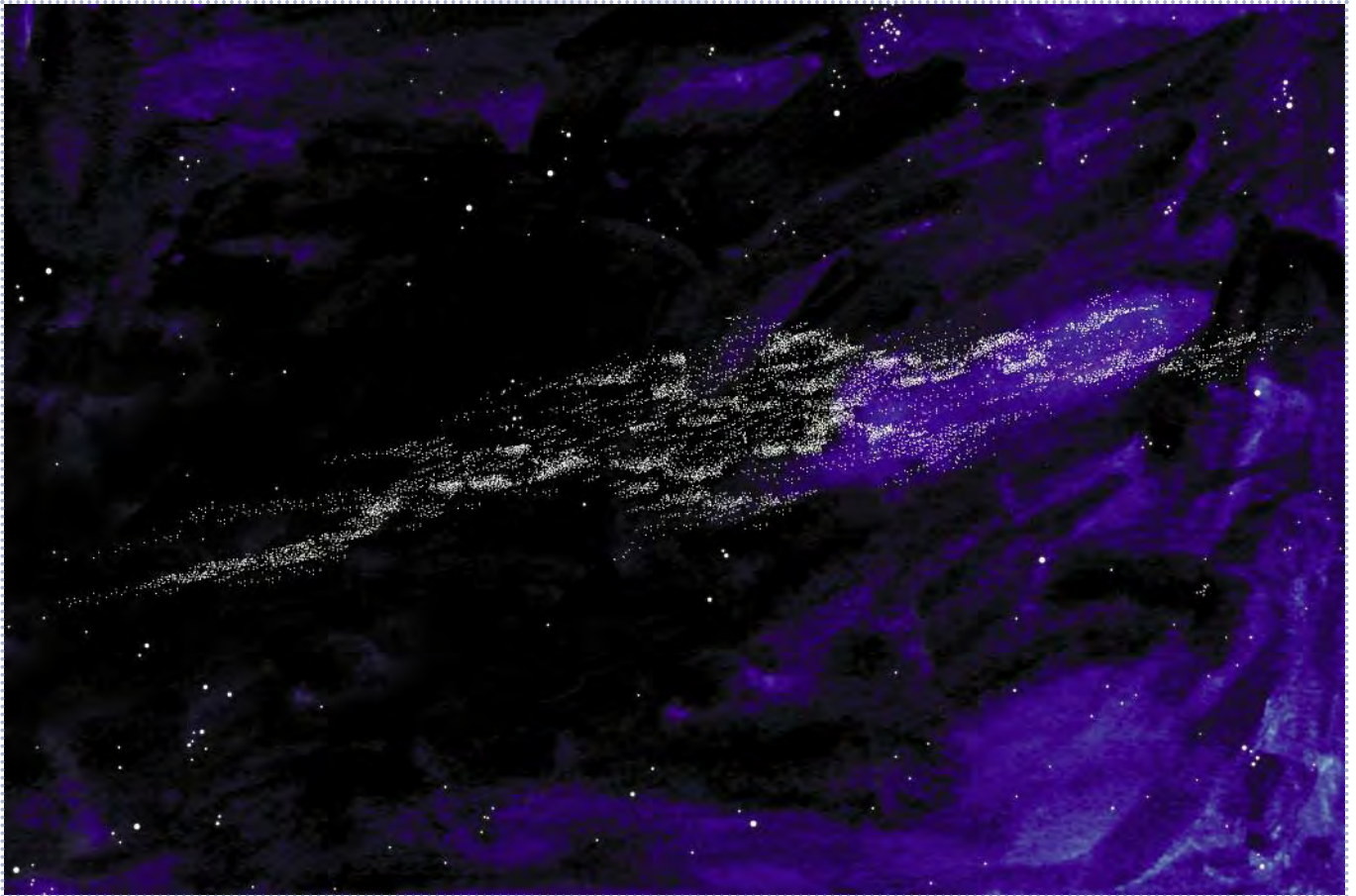

Cosmic dust sets complete with illuminator, fiber harness, scale 1:1 drilling template and instructions. These sets use 0,25mm fibers, exceedingly thin and challenging to install, but the effect is breathtaking.

Kits de polvo cósmico con iluminador, mazo de fibras, plantilla de taladrado a escala 1:1 e instrucciones de montaje. Estos kits usan fibras de 0,25mm, muy delgadas y complejas de instalar, pero el efecto es extraordinario.

CODE	PRODUCT	FIBERS	FIBER Ø	LENGTH	ILLUMINATOR
CES303	Cosmic dust kit	1800	0,25mm	2m	AHI**
CES304	Cosmic dust kit	3600	0,25mm	4m	AHI**
CES305	Cosmic dust kit	6000	0,25mm	6m	AHI**

On request we can manufacture these patterns or any other from a drawing or photograph.

** Available with low-noise fan.



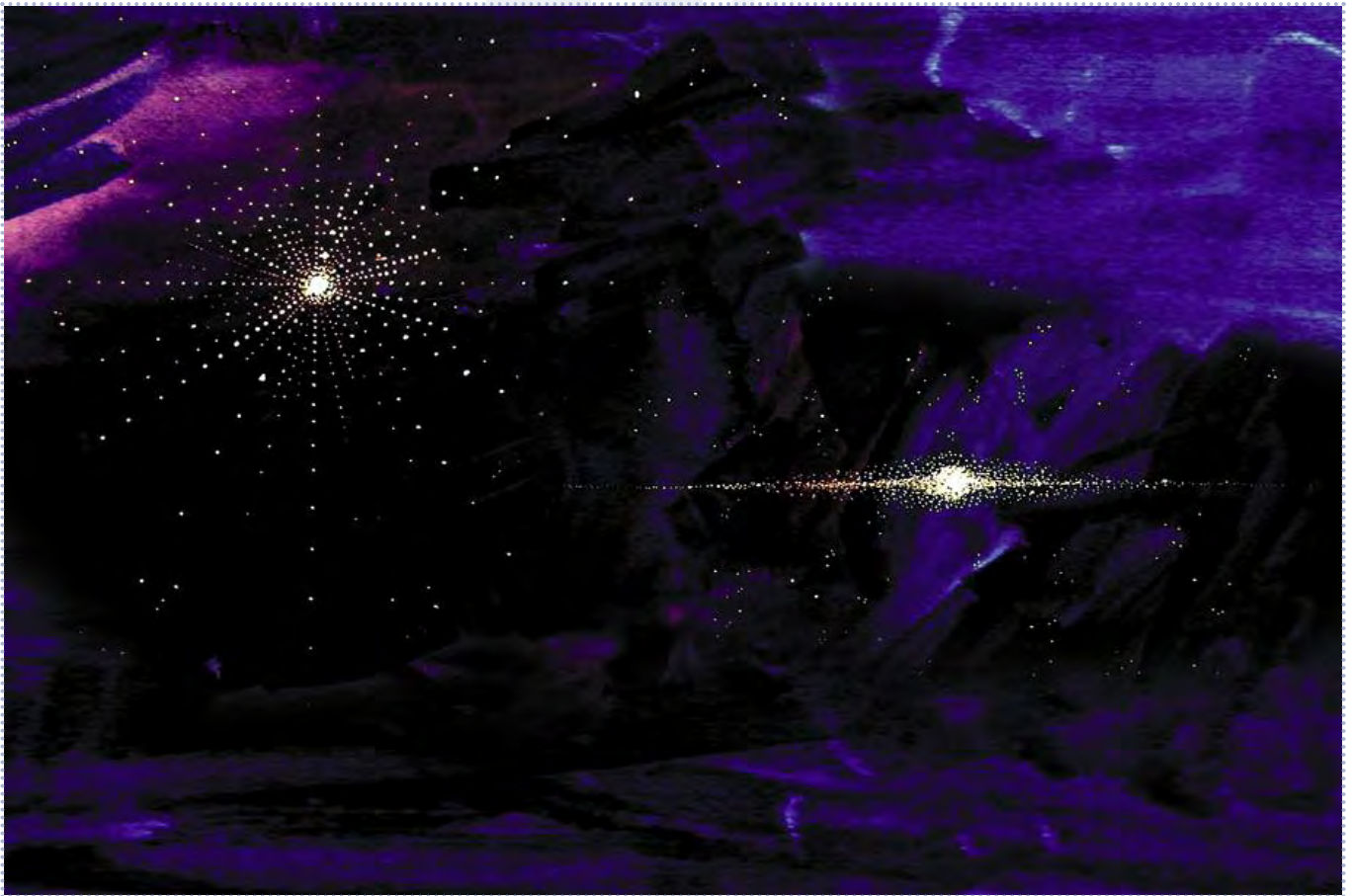

Supernovas in round or flat versions. Complete with illuminator, fiber harness, scale 1:1 drilling template and installation instructions.
Kits de supernova con iluminador, mazo de fibras, plantilla de taladrado a escala 1:1 e instrucciones.

CODE	PRODUCT	FIBERS	FIBER Ø	LENGTH	ILLUMINATOR
CES401	Supernova round kit	280	1,00mm	2m	AHI**
CES402	Supernova round kit	560	1,00mm	2m	AHI**
CES403	Supernova flat kit	1800	0,50mm	3m	AHI**
CES404	Supernova flat kit	3600	0,50mm	3m	AHI**
CES451	Supernova round kit	570	0,50mm	2m	ASI*

On request we can manufacture these patterns or any other from a drawing or photograph.

* Noiseless (no fan). ** Available with low-noise fan.



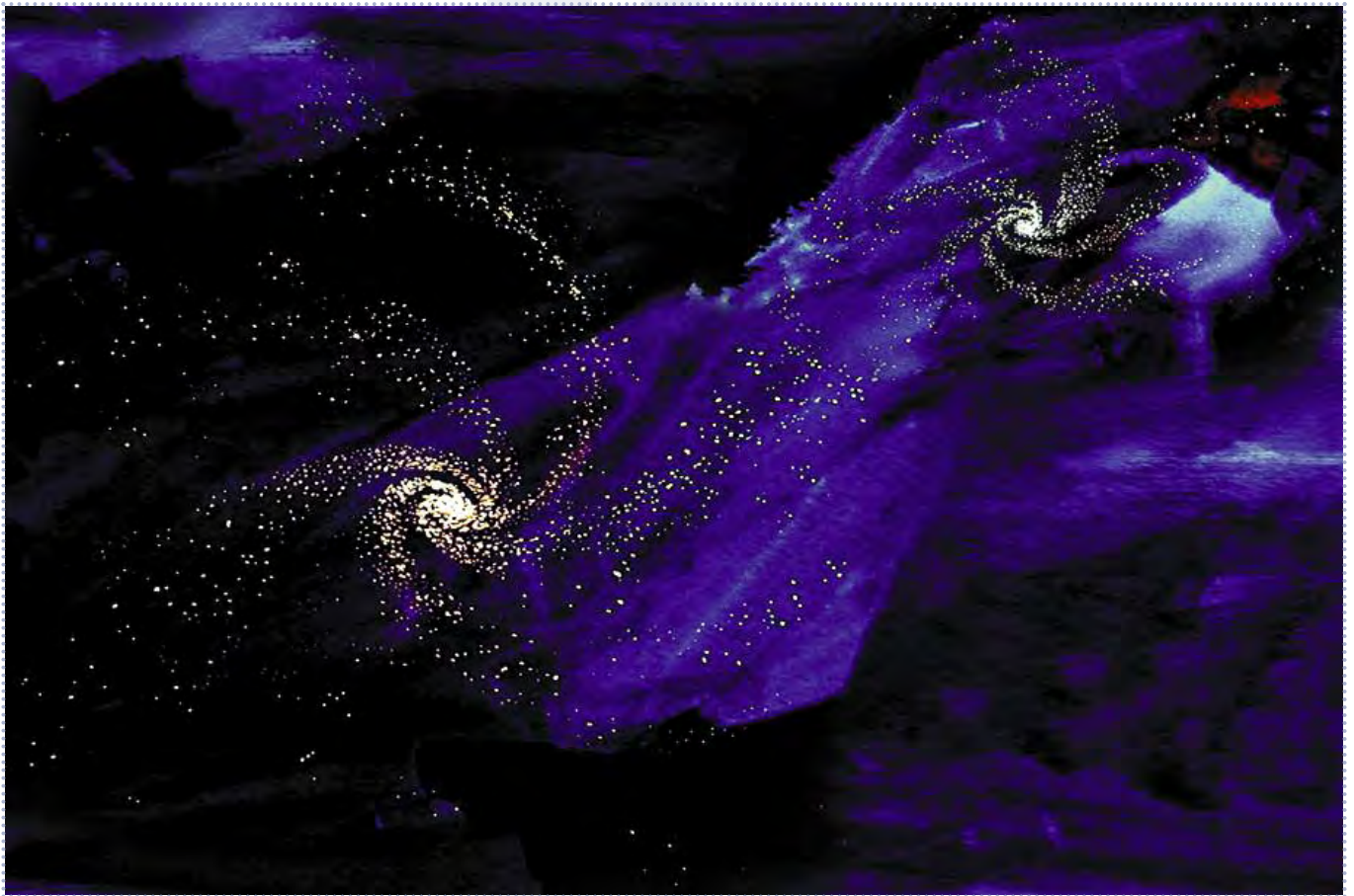

Nebulas in standard sizes, complete with illuminator/s, fiber harness/es, scale 1:1 drilling template and installation instructions. Custom made nebulas of any size are also available.

Kits de nebulosas en diferentes tamaños estándar, completos con iluminador, mazo/s de fibras, plantilla de taladrado a escala 1:1 e instrucciones. También disponibles en cualquier tamaño a medida.

CODE	PRODUCT	FIBERS	FIBER Ø	LENGTH	ILLUMINATOR
CES501	Nebula small kit	1800	0,50mm	2m	AHI**
CES502	Nebula large kit	3600	0,50mm	2m	AHI**
CES551	Nebula miniature kit	648	0,50mm	2m	ASI*

On request we can manufacture these patterns or any other from a drawing or photograph.

* Noiseless (no fan). ** Available with low-noise fan.

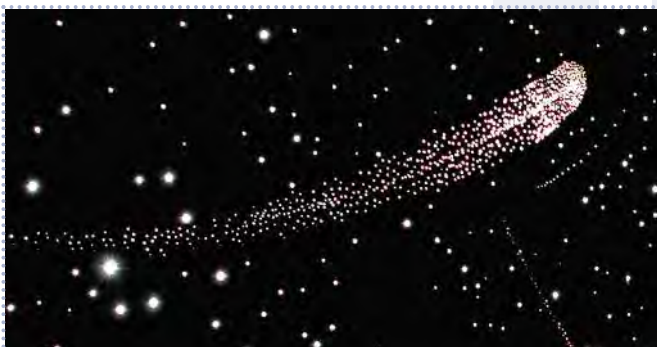



These nebula sets are extraordinary, eye-catching centrepieces bound to delight and awe any observer. We have custom produced very large nebulas with more than 500,000 individual fibers

Estos monumentales kits conforman efectos extraordinarios que sorprenden al observador. Hemos fabricado nebulosas de gran tamaño con más de 500.000 fibras individuales.

CODE	PRODUCT	FIBERS	FIBER Ø	LENGTH	ILLUMINATOR
CES503	Nebula super large kit (photo page 45)	11200	0,50mm	6m	AHI**
CES504	Nebula super large kit (photo above)	18000	0,50mm	6m	AHI**

On request we can manufacture these patterns or any other from a drawing or photograph.

** Available with low-noise fan.

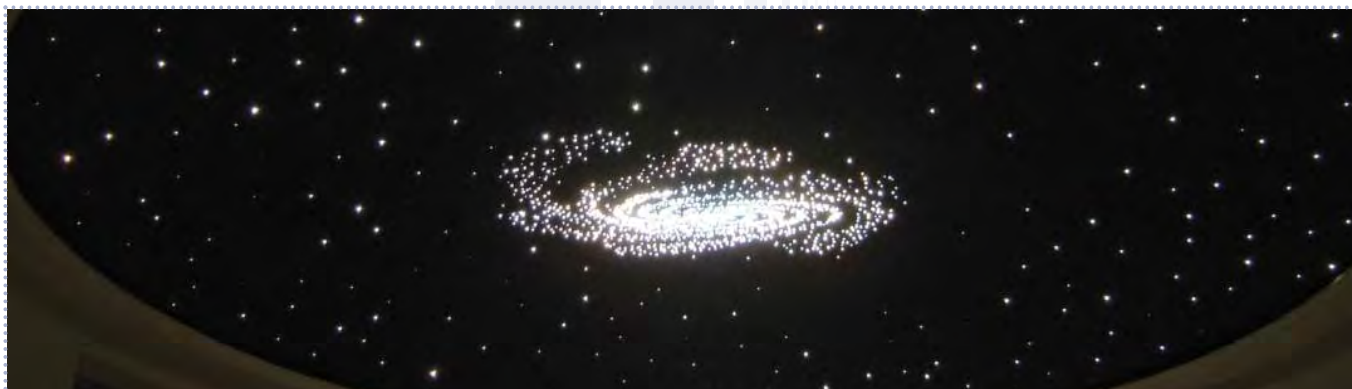



CES601 and CES602 with six bolides. CES603 and CES651, single fireball with "firetails". Complete with illuminator, fiber harness 1:1, drilling template and instructions.

Kits CES601 y CES602; seis bólidos. CES603 y CES651; bola de fuego con estelas. Completos con iluminador, mazo de fibras, plantilla 1:1 e instrucciones.

CODE	PRODUCT	FIBERS	FIBER Ø	LENGTH	ILLUMINATOR
CES601	Bolide short kit	1200	0,50mm	2m	AHI**
CES602	Bolide long kit	2400	0,50mm	3m	AHI**
CES603	Fireball large kit	1200	0,50mm	2m	AHI**
CES651	Bolide miniature kit	494	0,50mm	2m	ASI*

* Noiseless (no fan). ** Available with low-noise fan.

On request we can manufacture these patterns or any other from a drawing or photograph.

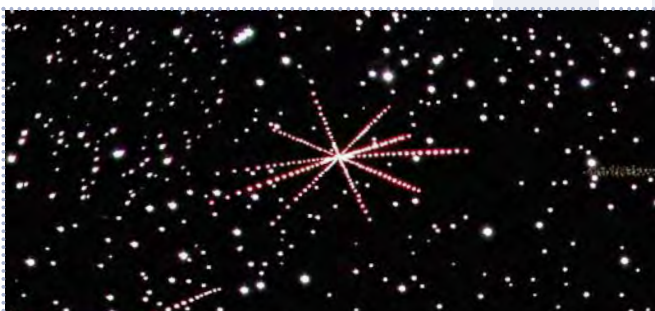

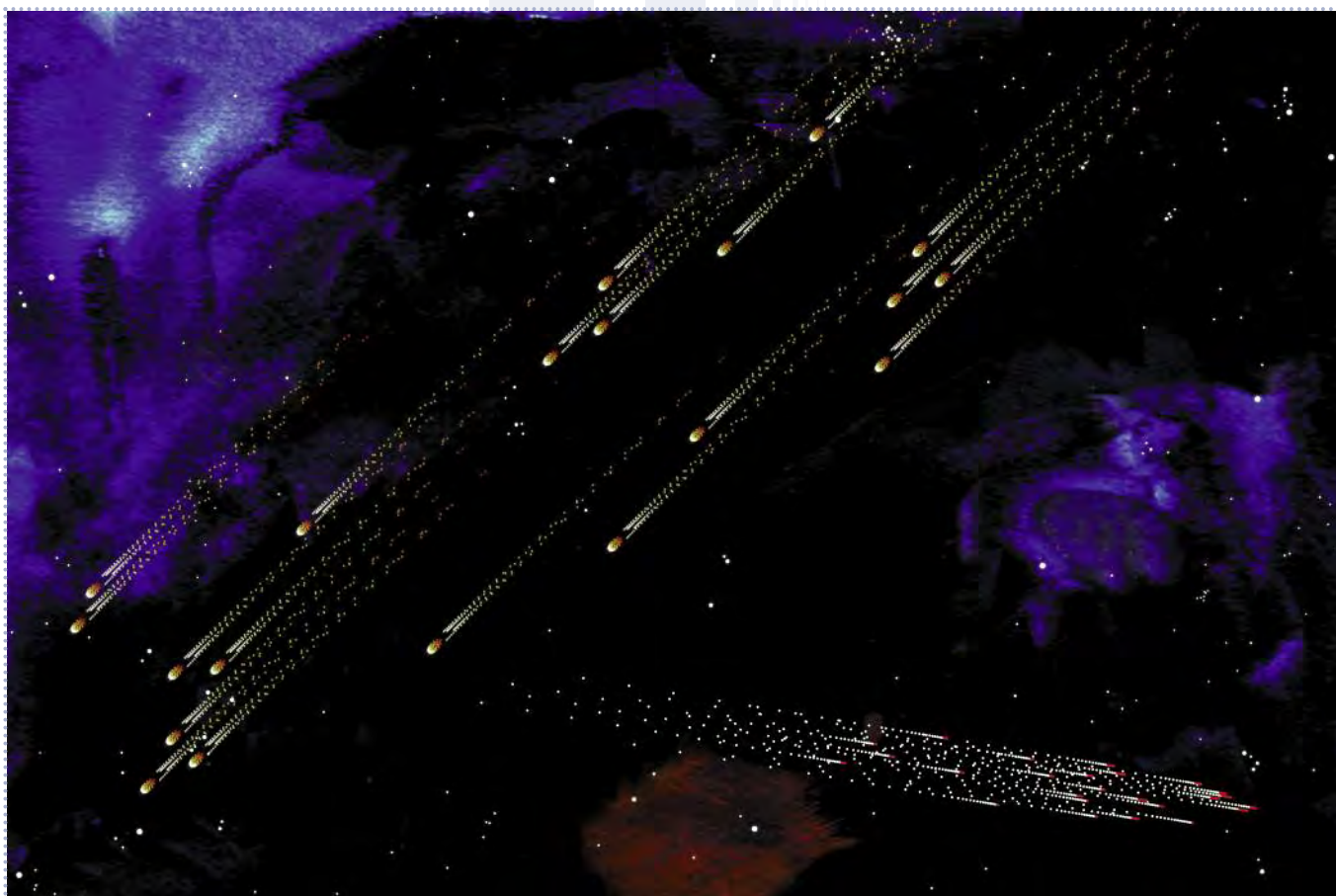

Sets with fast-chasing flaming meteoroids in different configurations. Complete with illuminator, fiber harness 1:1, drilling template and instructions.

Kits con meteoroides en diversas configuraciones. Completos con iluminador, mazo de fibras, plantilla 1:1 e instrucciones.

CODE	PRODUCT	FIBERS	FIBER Ø	LENGTH	ILLUMINATOR
CES610	Small meteoroid rain kit	660	0,50mm	3m	AHI**
CES611	Large meteoroid rain kit	1620	0,50mm	4m	AHI**

On request we can manufacture these patterns or any other from a drawing or photograph.

** Available with low-noise fan.



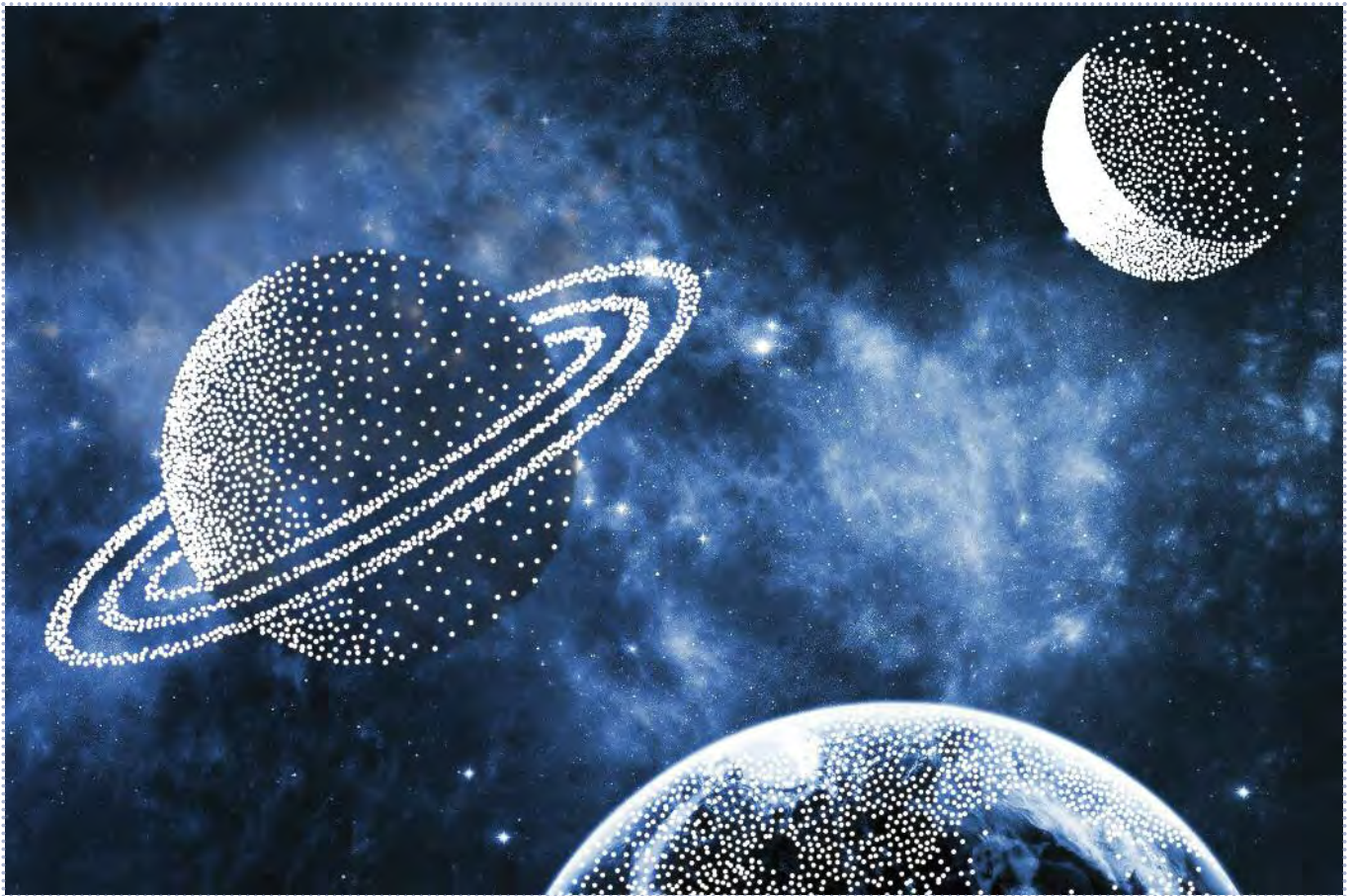

Saturn and moon cosmic effect sets; complete with illuminator, fiber harness, scale 1:1 drilling template and installation instructions.
Kits de efectos luna y Saturno; completos con iluminador, mazo de fibras, plantilla 1:1 e instrucciones de instalación.

CODE	PRODUCT	FIBERS	FIBER Ø	LENGTH	ILLUMINATOR
CES701	Saturn kit	2000	0,50mm	2m	AHI**
CES702	Moon kit	2000	0,50mm	2m	AHI**
CES751	Saturn miniature kit	508	0,50mm	2m	ASI*
CES752	Moon miniature kit	684	0,50mm	2m	ASI*

On request we can manufacture these patterns or any other from a drawing or photograph.

* Noiseless (no fan). ** Available with low-noise fan.



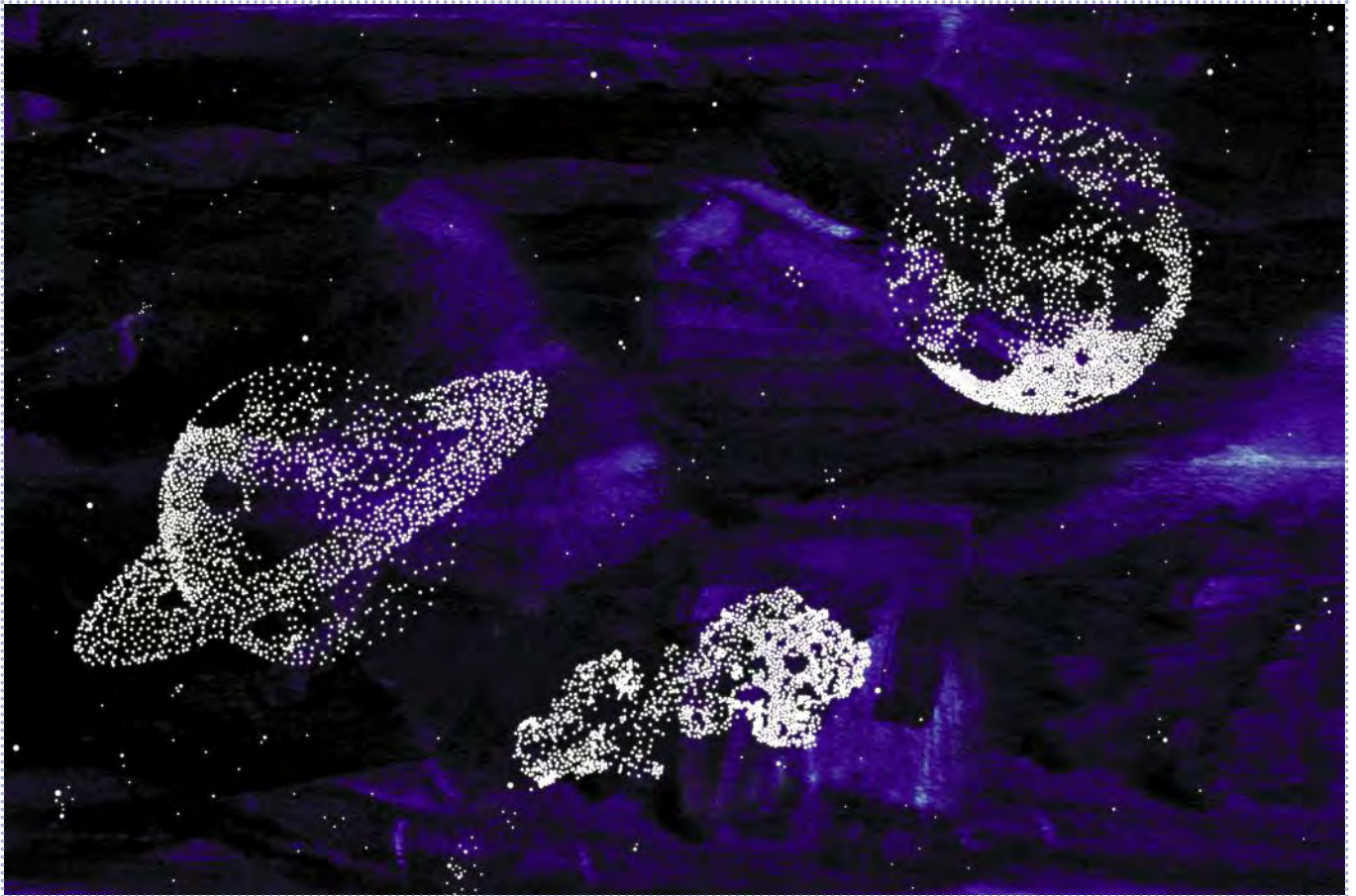

Realistic planets sets in diverse sizes and configurations complete with illuminator, fiber harness, scale 1:1 drilling template and installation instructions.

Kits de planetas de gran realismo en varios tamaños y configuraciones; completos con iluminador, mazo de fibras, plantilla 1:1 e instrucciones de instalación.

CODE	PRODUCT	FIBERS	FIBER Ø	LENGTH	ILLUMINATOR
CES703	Realistic Saturn kit	2000	0,50mm	2m	AHI color**
CES704	Realistic moon kit	2000	0,50mm	2m	AHI color**
CES705	Realistic meteorite kit	2000	0,50mm	2m	AHI color**

On request we can manufacture these patterns or any other from a drawing or photograph.

** Available with low-noise fan.

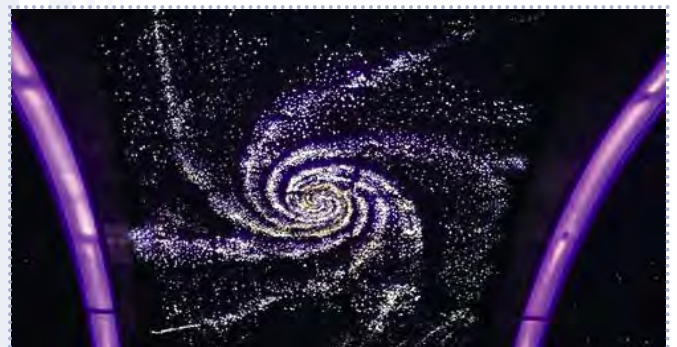

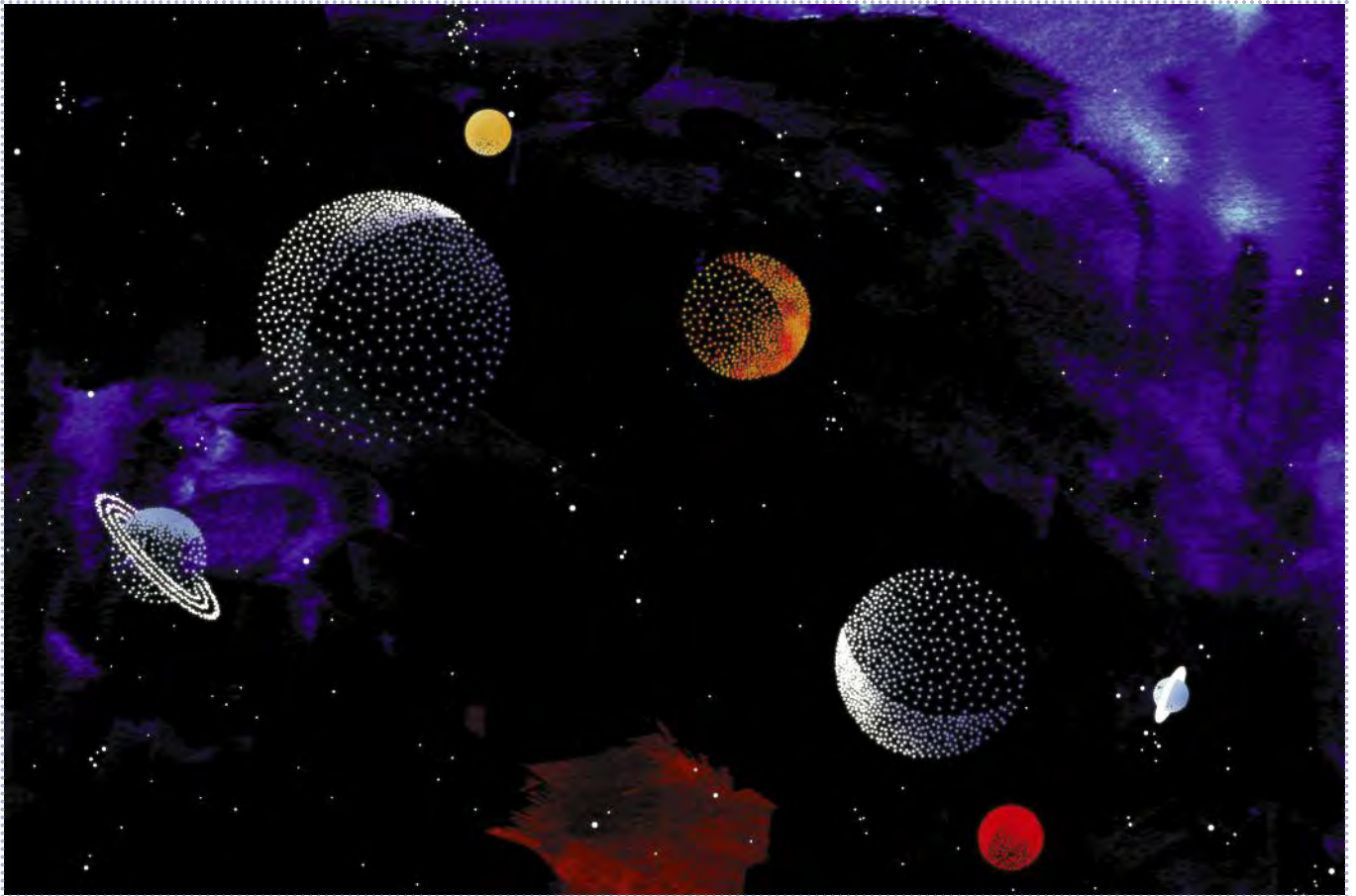

Multiple planets sets in diverse sizes and configurations complete with illuminator, fiber harness, scale 1:1 drilling template and installation instructions.

Kits de grupos de planetas de gran realismo en varios tamaños y configuraciones; completos con iluminador, mazo de fibras, plantilla 1:1 e instrucciones de instalación.

CODE	PRODUCT	FIBERS	FIBER Ø	LENGTH	ILLUMINATOR
CES721	Four-planet kit	1200	0,50mm	3m	AHI color**
CES722	Six-planet kit	1800	0,50mm	4m	AHI color**
CES723	Eight-planet kit	2400	0,50mm	6m	AHI color**

On request we can manufacture these patterns or any other from a drawing or photograph.

** Available with low-noise fan.

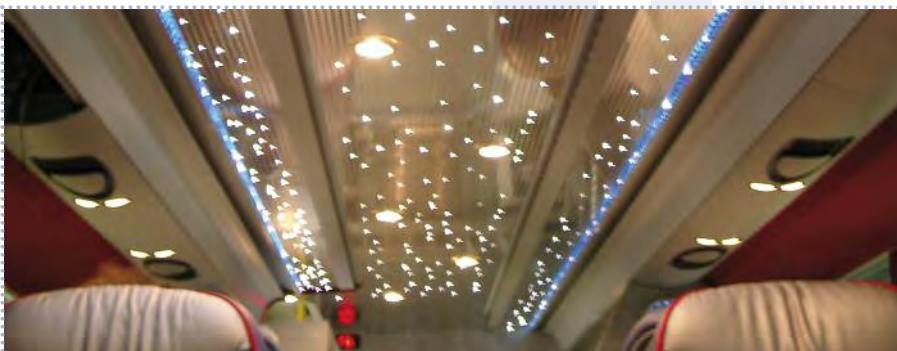



Decorative crystal sets to create patterns, effects or simply add to standard starry skies. Each set is complete with fiber harness, illuminator and crystal fittings.

Kits decorativos con cristales para la creación de efectos o mezclar con los firmamentos de fibra estándar. Cada kit se suministra completo con mazo de fibras, iluminador y juego de cristales.

CODE	PRODUCT	LIGHT GUIDES	CRYSTALS	LENGTH	ILLUMINATOR
CES861	Crystal kit	20 x 3mm	20	1,5 / 2m	XXX
CES862	Crystal kit	20 x 3mm	20	3 / 4m	XXX
CES863	Crystal kit	30 x 3mm	30	2,5 / 4,5m	XXX
CES864	Crystal kit	70 x 3mm	70	2,5 / 6,5m	XXX

On request we can manufacture kits with any number of fibers or crystals.



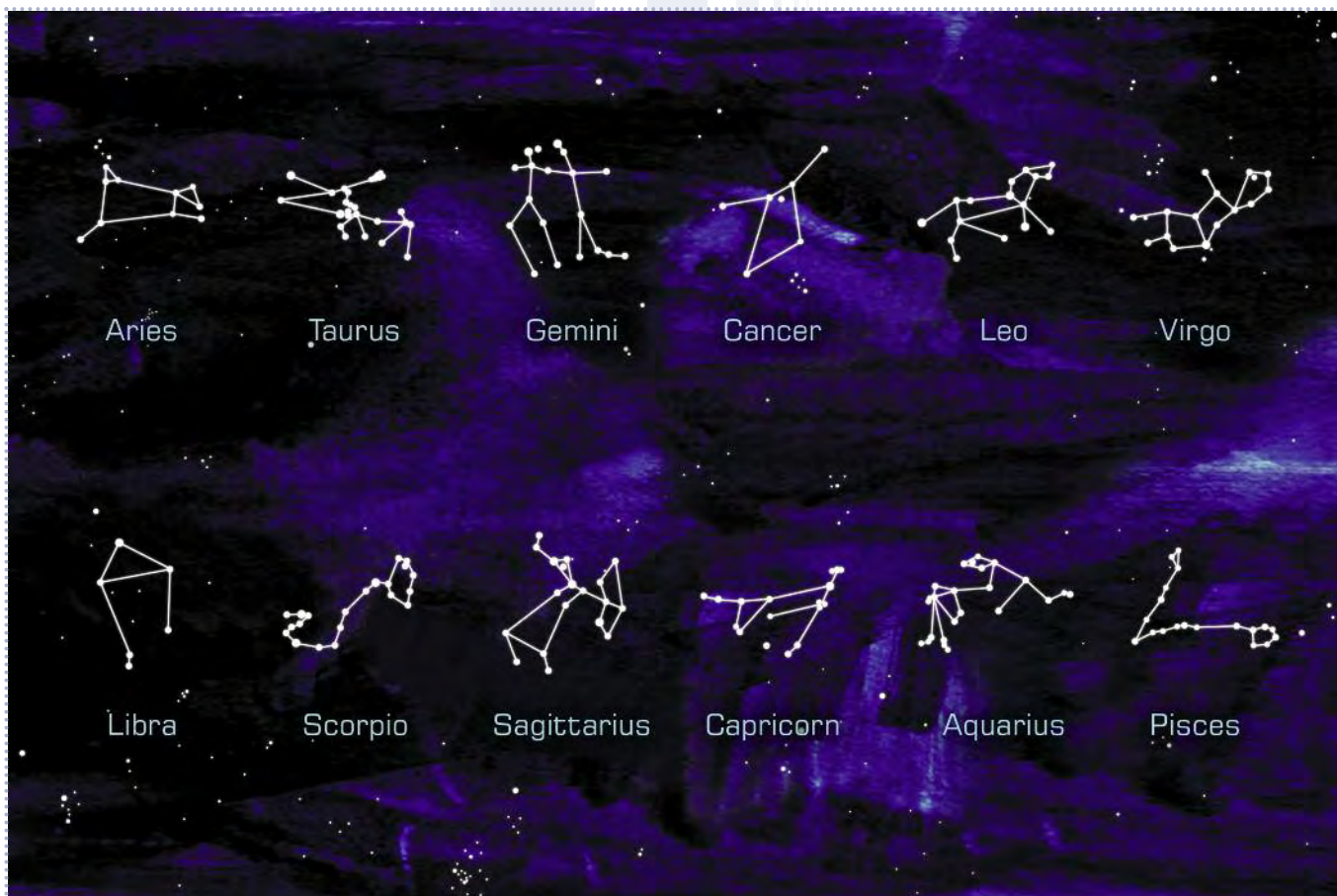

Sets of one or several zodiac signs containing the star configuration of the appropriate constellation, with harness, crystals, illuminator and drilling template. Also available in color or separate colors for each sign. Custom manufactured.

Kits de uno o varios signos del zodiaco con la configuración de la constelación adecuada, con mazo, cristales, iluminador y plantilla de taladrado. También disponible en color o con colores diferentes para cada signo.

SERIES	PRODUCT	FIBERS	LIGHT GUIDE Ø	LENGTH	ILLUMINATOR
CES950	Zodiac signs kits	Depending on sign	3mm	2m	SSI

One or several signs can be operated with the same illuminator.



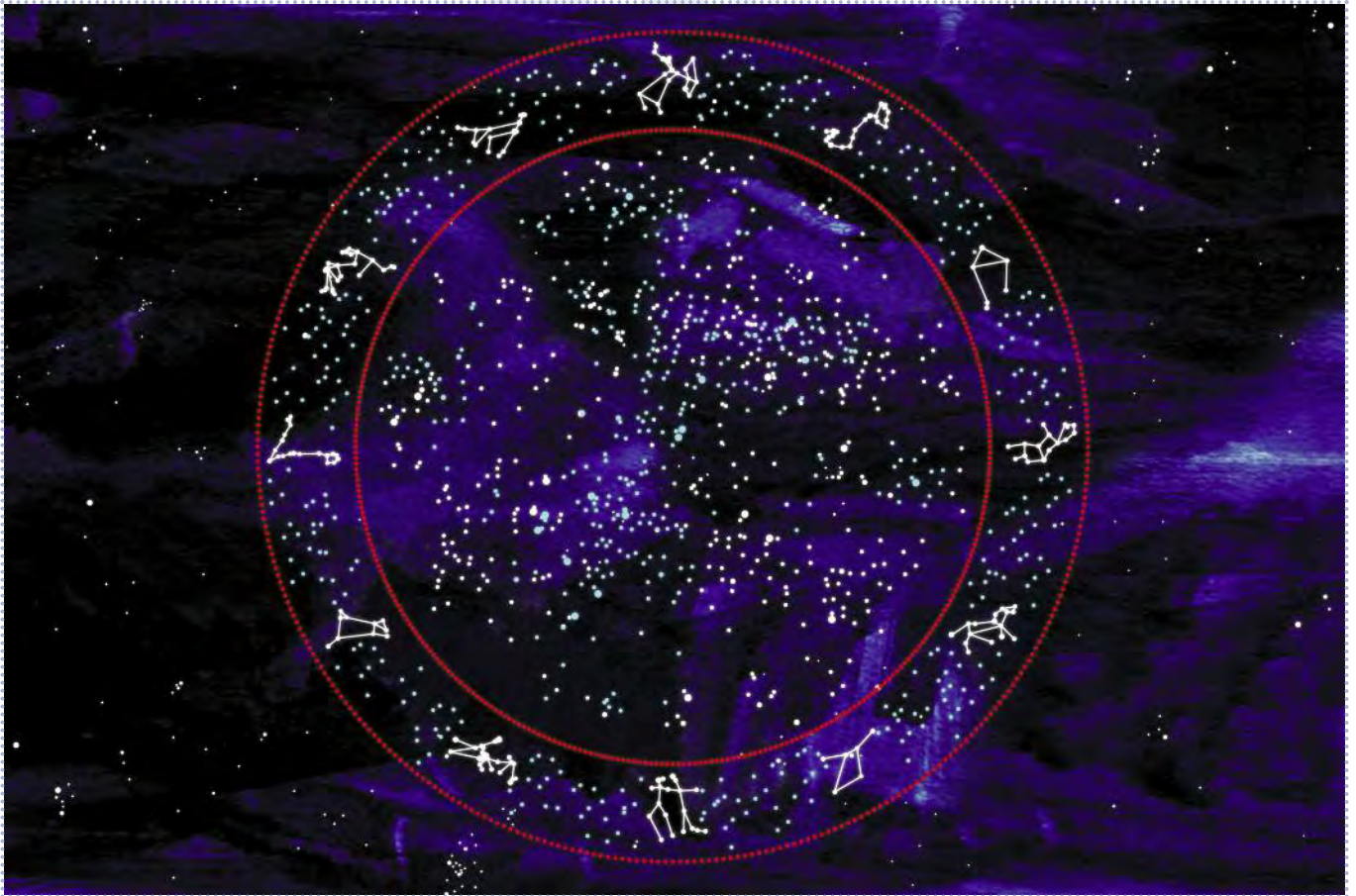

Kit with all the components to transform any ceiling into a zodiac ring. Custom manufactured to any size and complexity, complete with 1:1 templates.

Kit con los componentes para recrear un zodiaco completo en cualquier paramento. Fabricación bajo pedido con cualquier tamaño y complejidad. Se entrega completo con plantillas a tamaño real.

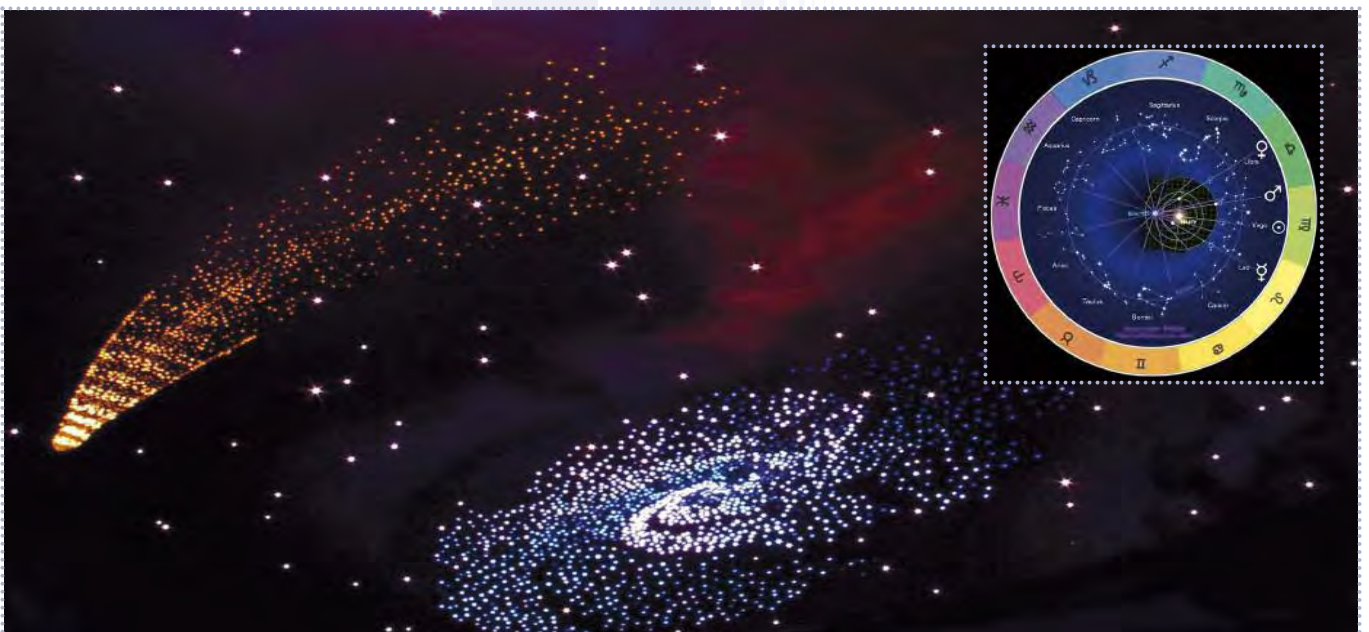



Kits with motives for the young, to incorporate into standard starry sky ceilings. Each set is complete with fiber harness, illuminator and 1:1 drilling template.

Kits con motivos para incorporar en firmamentos para los más jóvenes. Cada kit se entrega completo con mazo de fibras, iluminador y plantilla de taladrado a tamaño real.

CODE	PRODUCT	FIBERS	FIBER Ø	LENGTH	ILLUMINATOR
CES801	Moon and stars kit	795	0,50mm	2m	AHI**
CES802	Endeavor kit	391	0,50mm	2m	AHI**
CES803	Rocket kit	254	0,50mm	2m	AHI**
CES804	Witch kit	1425	0,50mm	2m	AHI**

Several of these or other effects can be driven from a single illuminator.

On request we can manufacture these patterns or any other from a drawing or photograph.

** Available with low-noise fan.





Kits of fireworks of varying levels of complexity; complete with illuminator, fiber harness, scale 1:1 drilling template and installation instructions.

Kits de fuegos artificiales con varios niveles de complejidad; completos con iluminador, mazo de fibras, plantilla 1:1 e instrucciones de instalación.

CODE	PRODUCT	FIBERS	FIBER Ø	LENGTH	ILLUMINATOR
CES741	Two-firework kit	1120	0,50mm	3m	AHI**
CES742	Four-firework kit	2240	0,50mm	4m	AHI**

On request we can manufacture these patterns or any other from a drawing or photograph.

** Available with low-noise fan.



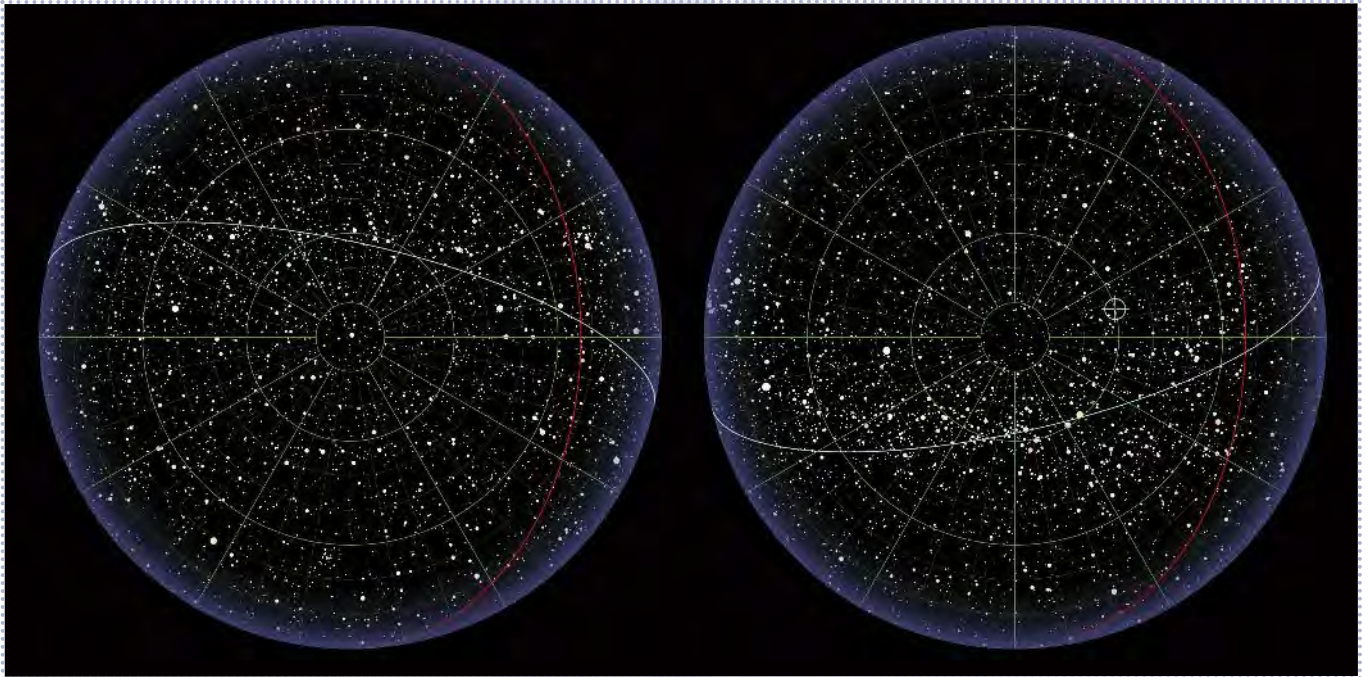

Beside scale reproductions of accurate sections of the sky at night to full hemispheres, we can manufacture any pattern, drawing or scene at any size or level of complexity.

Además de reproducciones a escala de sectores del firmamento nocturno e incluso hemisferios completos, fabricamos cualquier patrón, dibujo o esquema a cualquier tamaño o nivel de complejidad.





SDA products are large-sized polymer shapes delivered complete with all fibers installed and illuminator. Can also be ordered with any CES kit above installed in the dome. Wooden transport crate included.

Los productos SDA son formas en polímero de gran tamaño que incluyen fibras instaladas e iluminador. Disponibles con cualquiera de los kits CES. Suministrados en embalaje de madera.

SERIES	TYPE	HEIGHT	SIZE
SDA100	Semisphere	From 290mm to 840mm	From Ø Int. 600mm to 1800mm
SDA200	Square	From 180mm to 330mm	From 600 x 600mm to 1800 x 1800mm
SDA300	Rectangle	From 115mm to 180mm	From 400 x 700mm to 700 x 1000mm
SDA400	Round	From 130mm to 330mm	From Ø Int. 600mm to 1800mm





Solid State Illuminator & Kits | Iluminador Estado Sólido y Kits

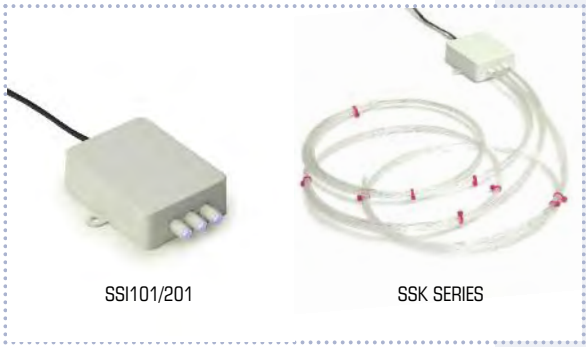

Solid state illuminator (12V) with 3 LEDs for small starry skies or decorative applications. SSK is supplied with pre-cut and assembled harnesses.

Iluminador de estado sólido SSI (12V) con 3 LED para pequeños cielos estrellados o aplicaciones decorativas. El SSK se entrega con mazos de fibra.

CODE	PRODUCT	TYPE	DIMENSIONS
SSI101	Solid state illuminator	Oscillating light	L 73mm x W 75mm x H 22mm
SSI201	Solid state illuminator	Static light	L 73mm x W 75mm x H 22mm

SSK kits manufactured to any length and compositions of fibers on request.

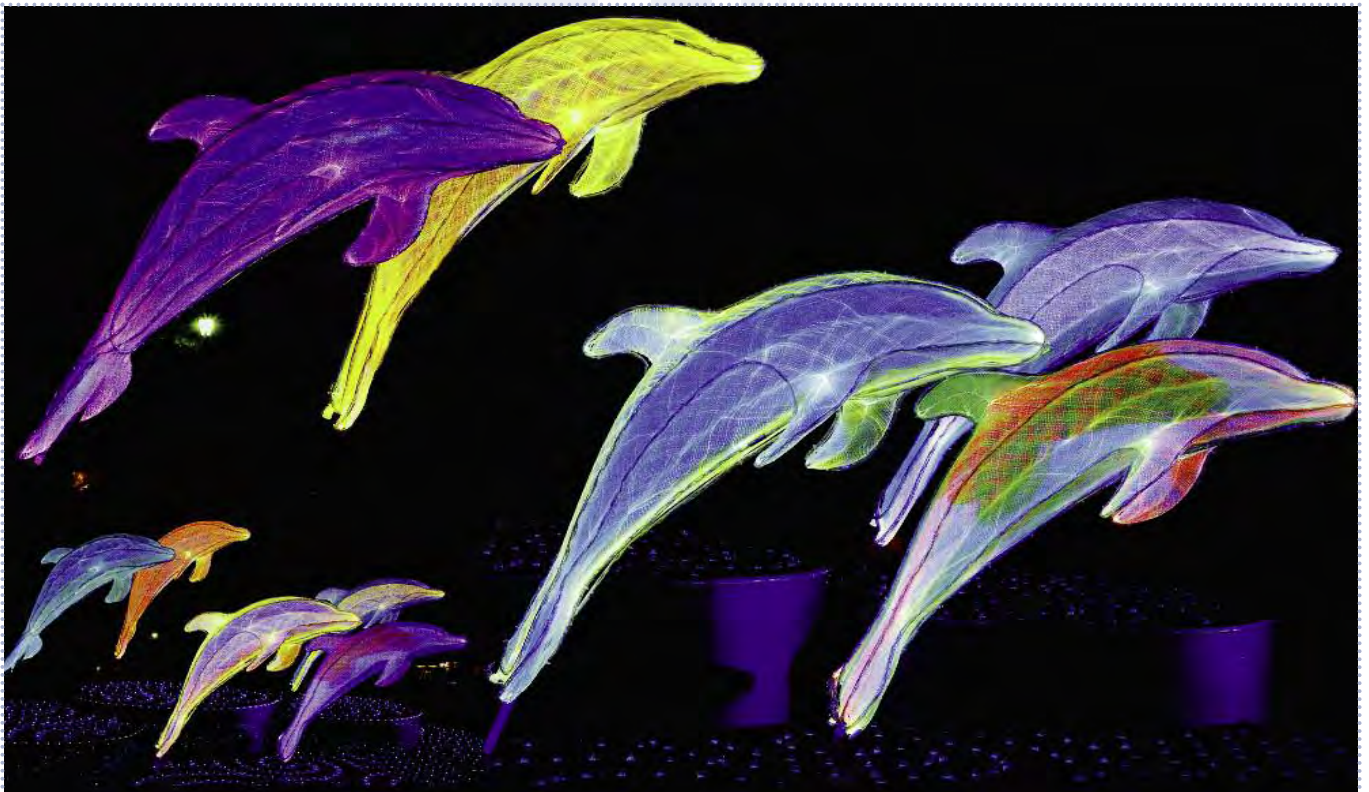



At AFO, we specialize in custom solutions. With our vast experience, we can undertake projects from beginning to end and develop innovative solutions for the most demanding lighting designs.

En AFO nos especializamos en soluciones a medida. Ofrecemos a nuestros clientes una amplia experiencia en proyectos y desarrollamos soluciones innovadoras para los diseños de iluminación más exigentes.

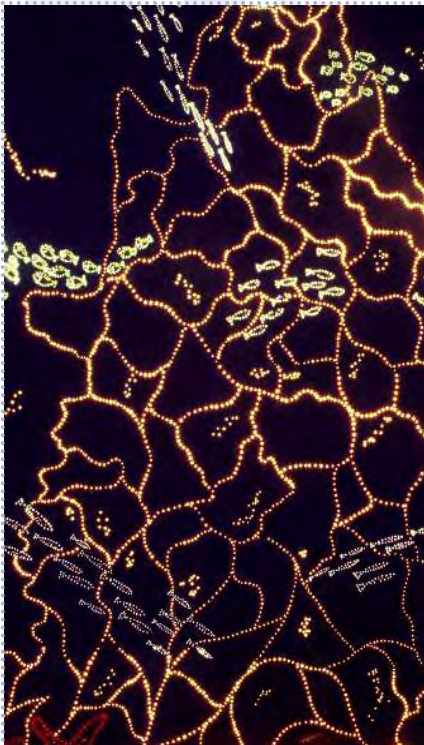

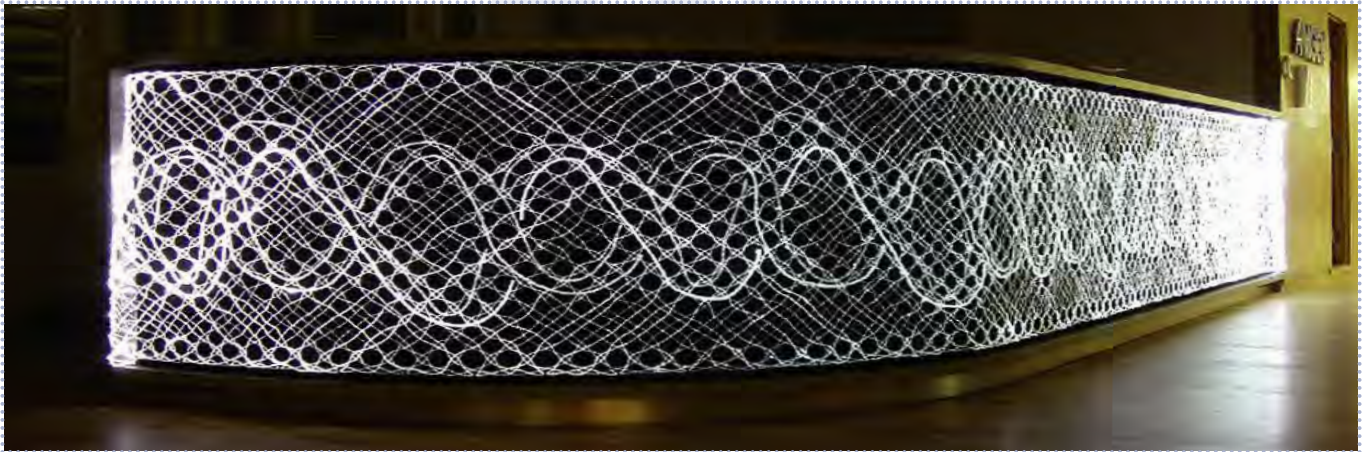

All images appearing in the Advanced Fiber Optics Catalogue site are copyrighted © 2001 – 2010 and the exclusive property of Advanced Fiber Optics distributors, clients and collaborators and protected under International Copyright laws.
The images may not be reproduced, copied, transmitted or manipulated without the written permission of the copyright holder(s).
Cover photograph © Bruce Munro.

www.afo.es

Fiber Optics

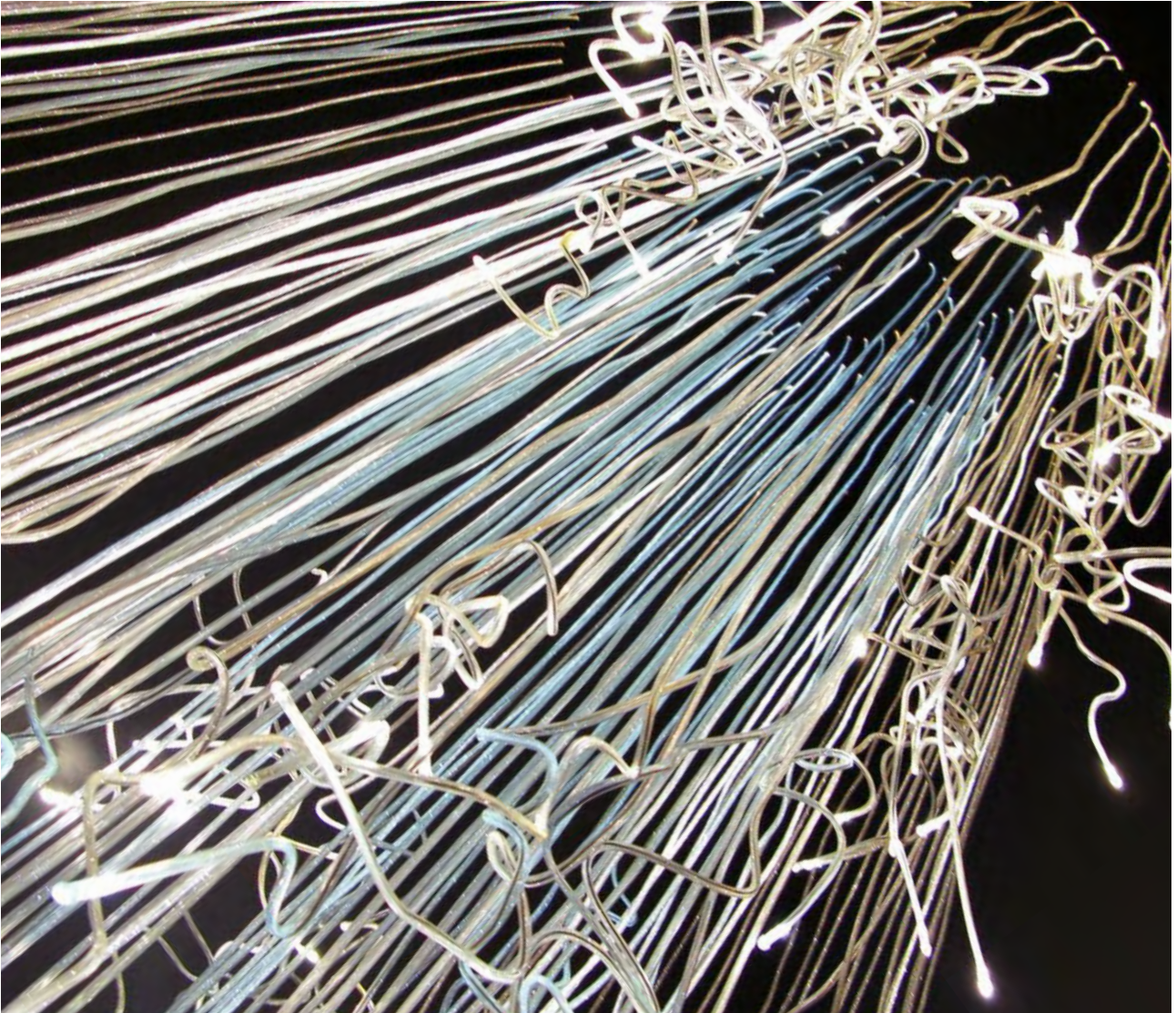

Layout & Digital Art: L. M. Cano ©2010 Advanced Fiber Optics, S.L. MKT160

Distributed by:



Advanced Fiber Optics, S.L. - Castillejos, 427 - 08024 Barcelona Spain - Tel. +34 93 455 72 00 Fax +34 93 446 23 28 - info@afo.es