

BALAUSTRADAS EN PIEDRA ARTIFICIAL

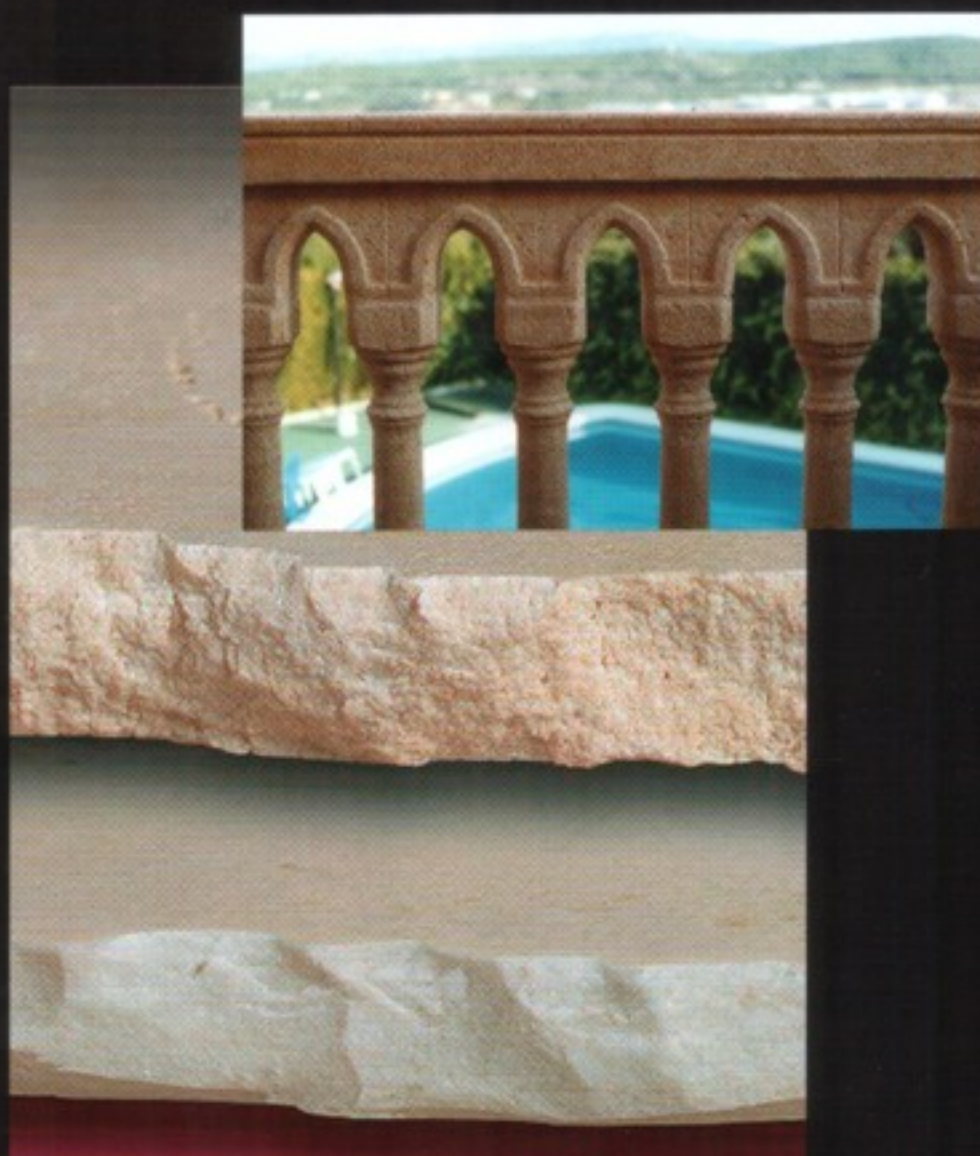

BALARTI
BALAUSTRADAS



PASAMANOS Y RODAPIÉ

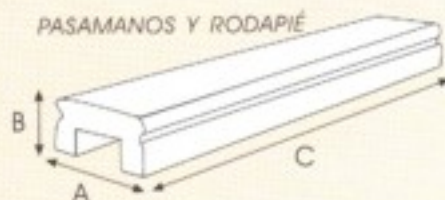

PASAMANOS Y RODAPIÉS

Dimensiones en cm.			Peso pieza kg.	Piezas Palet	Peso Palet kg.
A	B	C			
16	9	100	23	36	828

• Las escaleras se montan sin arcos, ya que éste solamente se pone en línea horizontal y no inclinada.

• Las piezas de arcos solo se podrán montar sobre los balaustres de 40 y 63 cm.

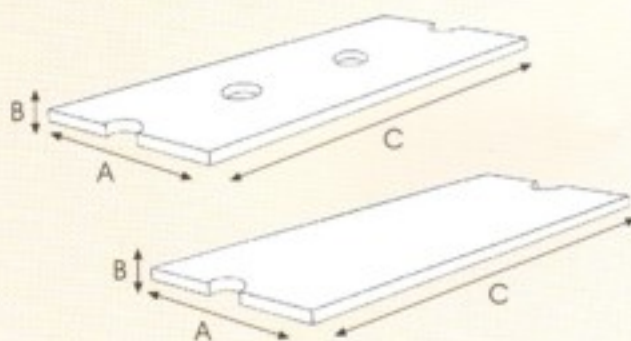

TABLILLA DE MONTAJE

Dimensiones en cm.			Peso pieza kg.
A	B	C	
15	2	60	3,5

BALAUSTRÉS

MODELO	Dimensiones en cm.		Peso pieza Kg.	Piezas palet	Piezas palet Kg.
	A	B			
Bal - 40	12	40	7	64	448
Bal - 40 Terminal	6	40	3	-	-
Bal - 63	12	63	9,50	64	608
Bal - 63 Terminal	6	63	4,50	-	-
Bal - 75	14	75	15,50	49	760

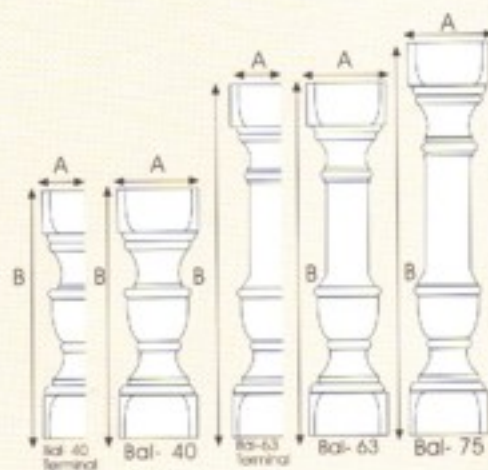



• Este tipo de material se fabrica en color beige, con áridos de mármol, por lo que son inevitables ligeras variaciones de tono.

• Tanto el rodapié como pasamanos son la misma pieza, con el fin de simplificar los elementos a la hora del montaje.

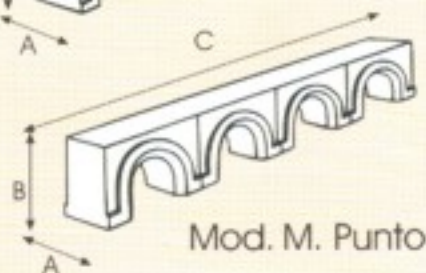
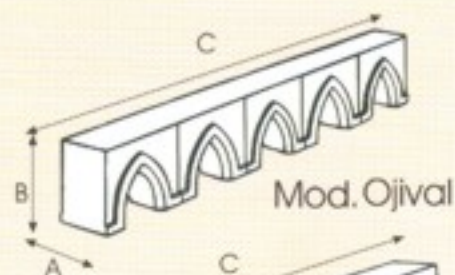

ARCOS

MODELO	Dimensiones en cm.			Peso Pieza kg.	Piezas Palet	Peso palet kg.
	A	B	C			
Medio Punto	12	16	100	26	32	832
Ojival	12	16	100	29	32	928



TERMINAL DE PILAR

Dimensiones en cm.		Peso pieza kg.
A	B	
24	8	9

PILAR

Dimensiones en cm.			Peso pieza kg.	Piezas Palet	Peso Palet kg.
A	B	C			
20	100	24	65	12	780

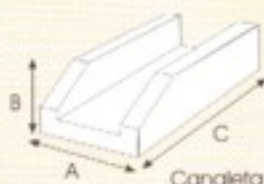

CANALETA

Dimensiones en cm.			Peso pieza kg.
A	B	C	
13	6	28	3,5

BORDILLO CON JARDÍN

Dimensiones en cm.		Peso pieza kg.
A	B	
50	28	11

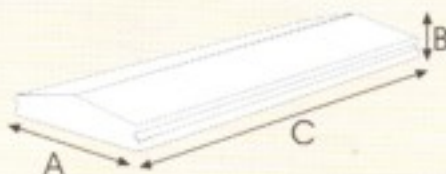

CUBREMUIROS

CUBREMUIROS

Dimensiones en cm.			Peso pieza kg.
A	B	C	
38	10	100	55



PIÑA

Dimensiones en cm.		Peso pieza kg.
A	B	
16	20	6,5

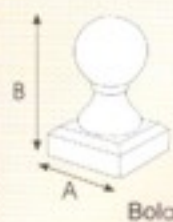

TERMINAL CON BOLA

Dimensiones en cm.		Peso pieza kg.
A	B	
24	38	19



PASAMANOS Y RODAPIÉ

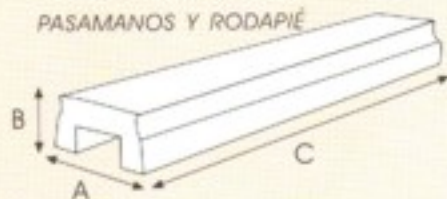

PASAMANOS Y RODAPIÉS

Dimensiones en cm.			Peso pieza kg.	Piezas Palet	Peso Palet kg.
A	B	C			
19	9	100	27	35	945



- Travertino es Caliza Extratificada. Concrecionada y con cierta porosidad.



- Balarti ha conseguido, introducir todas estas características en su modelo Travertino, desarrollando una balaustrada elegante y clásica.

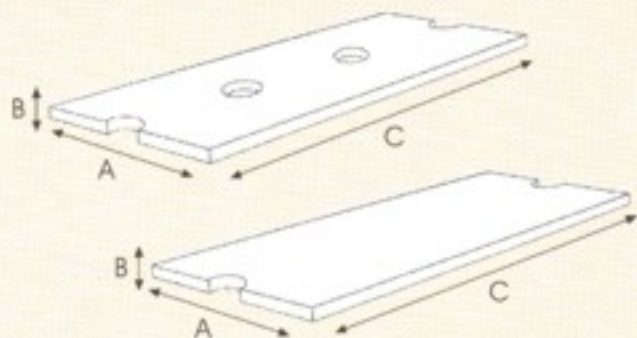

TABILLA DE MONTAJE

Dimensiones en cm.			Peso pieza kg.
A	B	C	
18	2	60	4,5



BALAUSTRAS

MODELO	Dimensiones en cm.		Peso pieza Kg.	Piezas palet	Piezas palet Kg.
	A	B			
Bal - 40	12	40	6	64	384
Bal - 63	14	63	16	49	784
Bal - 75	14	75	17	49	833

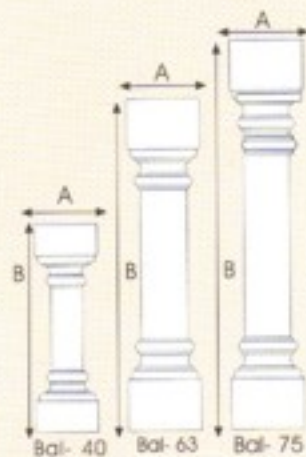

- Este material se fábrica en color márfil con áridos de mármol, por lo que son inevitables ligerísimas variaciones de tono.



TERMINAL DE PILAR

Dimensiones en cm.		Peso pieza kg.
A	B	
24	8	9

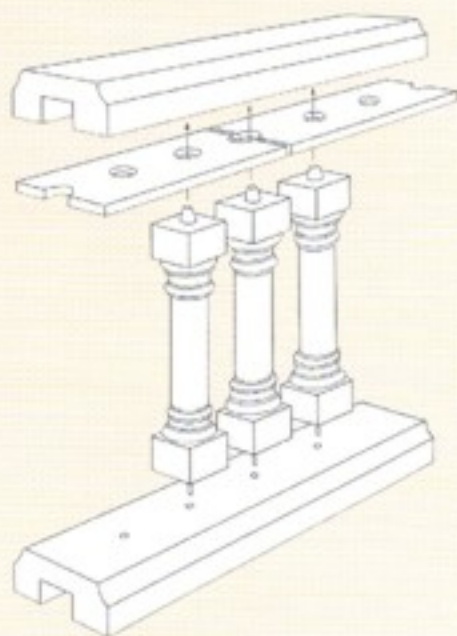
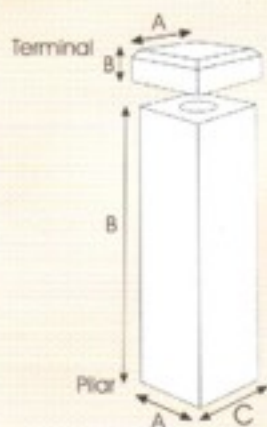

PILAR

Dimensiones en cm.			Peso pieza kg.	Piezas Palet	Peso Palet kg.
A	B	C			
20	100	20	73,5	12	882

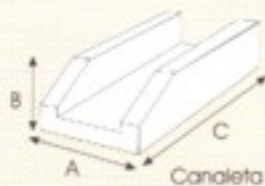

CANALETA

Dimensiones en cm.			Peso pieza kg.
A	B	C	
13	6	28	3,5

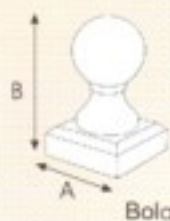

TERMINAL CON BOLA

Dimensiones en cm.		Peso pieza kg.
A	B	
24	38	19

ARENISCA

BALARTI
BALAUSTRADAS



BALAUSTRADA 40 58X100

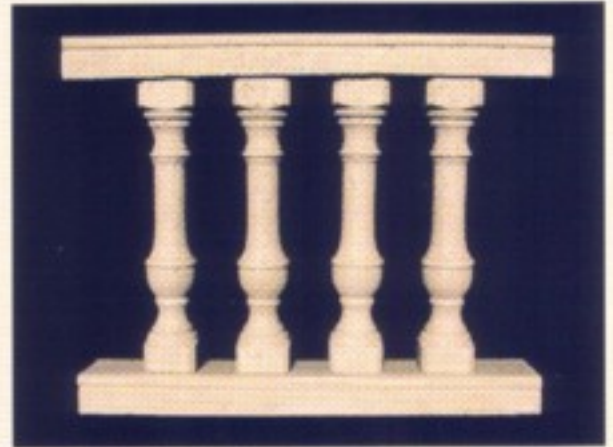

BALAUSTRADA 63 81X100

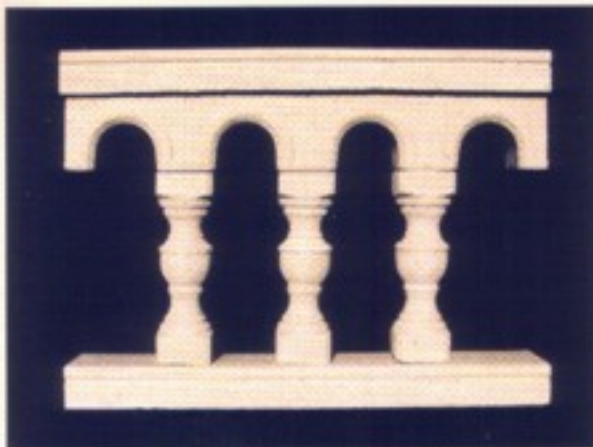

BALAUSTRADA 40 ARCO MEDIO PUNTO 74X100



BALAUSTRADA 63 ARCO MEDIO PUNTO 97X100

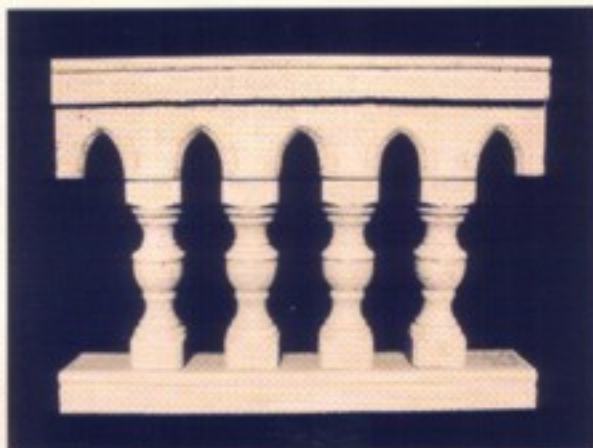

BALAUSTRADA 40 OJIVAL 74X100



BALAUSTRADA 63 OJIVAL 97X100



BALAUSTRADA 75 93X100

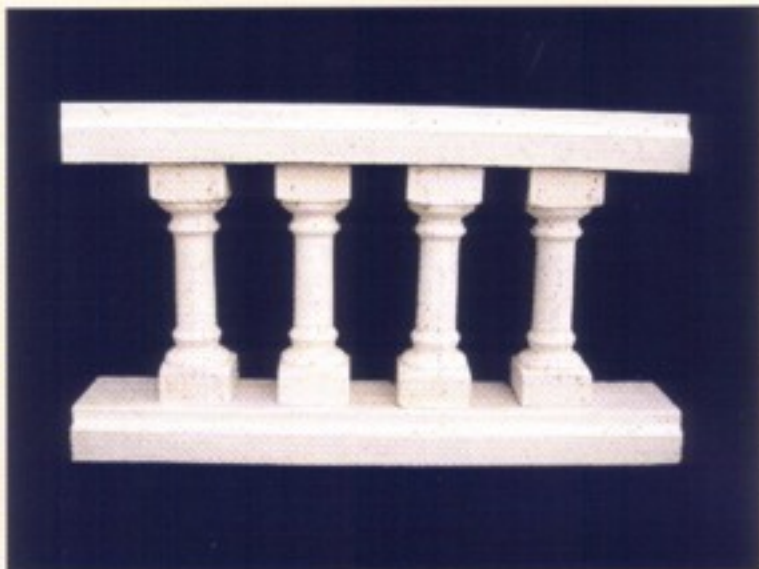

BALAUSTRADA 40
58X100



BALAUSTRADA 63
81X100



BALAUSTRADA 75
93X100



CAMPOS ORRICO S.A.

**CAMINO DE LAS FUENTES, 30
TLF. Y FAX 968 70 82 67
30400 CARAVACA DE LA CRUZ
MURCIA - ESPAÑA**

**www.balarti.com
E-mail: balarti@balarti.com**