

Tarifa de precios

Sistemas de instalación industrial

Julio

2008



Schneider
 **Electric**

clientes
satisfechos
nuestra prioridad n°1

1.1 Bandejas

• Metalnorma	4
• Rejinorma	34



METALNORMA

CARACTERÍSTICAS GENERALES

- Metalnorma es la bandeja de metal de Aemsa.
- Disponible en dos versiones, bandeja ciega y bandeja perforada, para dar respuesta a cada tipo de instalación.
- Metalnorma se distingue por su especial diseño sin aristas cortantes, pensado para la seguridad de quien manipula la instalación y para los propios cables.
- Además resaltan las bases embutidas, por troquelado y por perfiles longitudinales, de las medidas 300, 400, 500 y 600 específicas para garantizar una mayor resistencia de carga
- Metalnorma está disponible, con todos sus accesorios, en dos acabados cada uno de ellos identificado por un color:
 - Galvanizado Sendzimir - Color Azul
 - Galvanizado en caliente - Color Rojo

PROPIEDADES

Longitud estándar: Galvanizado Sendzimir - 3 metros
Galvanizado en caliente - 2 metros

Propiedades eléctricas: con continuidad eléctrica

Propiedades mecánicas: resistencia al impacto 20J

Propiedades contra la penetración de sólidos y líquidos: Bandejas perforadas con tapa grado - grado IP2X
Bandejas ciegas con tapa - grado IP64

CAMPO DE APLICACIÓN

- Aplicaciones por acabado:
 - Galvanizado Sendzimir- para instalaciones en lugares con agresividad moderada o media
 - Galvanizado en caliente- para instalaciones en lugares con agresividad alta







Hay que destacar que el diseño de la soportería de Metalnorma hace posible que muchos accesorios puedan servir tanto para la bandeja de metal, como la de PVC y la de rejilla.

ACABADO SENDZIMIR										
Dimensiones (alto x ancho)	15x50 *	15x75 *	15x100 *	30x100	30x150	30x200	30x300	60x60	60x100	60x150
Bandejas										
Bandeja perforada	47 11 105 16 m. 7,13 €/m	47 11 107 16 m. 9,59 €/m	47 11 110 16 m. 10,60 €/m	47 11 210 12 m. 11,27 €/m	47 11 215 6 m. 14,27 €/m	47 11 220 6 m. 19,14 €/m	47 11 230 6 m. 24,98 €/m	47 11 306 12 m. 11,81 €/m	47 11 310 6 m. 14,34 €/m	47 11 315 6 m. 18,69 €/m
Bandeja ciega	-	-	-	47 14 210 12 m. 11,27 €/m	47 14 215 6 m. 14,27 €/m	47 14 220 6 m. 19,14 €/m	47 14 230 6 m. 24,98 €/m	47 14 306 12 m. 11,81 €/m	47 14 310 6 m. 14,34 €/m	47 14 315 6 m. 18,69 €/m
Tapa										
Tapa para bandeja	-	-	47 21 100 4 m. 8,11 €/m	47 21 100 4 m. 8,11 €/m	47 21 150 4 m. 10,33 €/m	47 21 200 4 m. 12,76 €/m	47 21 300 4 m. 20,31 €/m	47 21 060 8 m. 6,36 €/m	47 21 100 4 m. 8,11 €/m	47 21 150 4 m. 10,33 €/m
Uniones										
Brida de unión lateral (1)	-	-	-	47 21 830 10 ud. 1,97 €/ud						
Brida de unión central (1)	-	-	-	-	-	-	47 21 900 10 uds. 1,70 €/ud	-	-	-
Brida de unión central doble (1)	-	-	-	-	-	-	-	-	-	-
Multipieza (1)	-	-	-	47 21 930 1 ud. 14,34 €/ud						
Accesorios										
Curva de 90°	-	-	-	47 31 210 1 ud. 33,41 €/ud	47 31 215 1 ud. 37,30 €/ud	47 31 220 1 ud. 42,76 €/ud	47 31 230 1 ud. 49,58 €/ud	47 31 306 1 ud. 34,18 €/ud	47 31 310 1 ud. 34,81 €/ud	47 31 315 1 ud. 38,99 €/ud
Tapa curva de 90°	-	-	-	47 31 710 1 ud. 26,21 €/ud	47 31 715 1 ud. 30,73 €/ud	47 31 720 1 ud. 31,68 €/ud	47 31 730 1 ud. 45,09 €/ud	47 31 706 1 ud. 17,06 €/ud	47 31 710 1 ud. 26,21 €/ud	47 31 715 1 ud. 30,73 €/ud
Cambio de nivel cóncavo	-	-	-	47 41 210 1 ud. 36,74 €/ud	47 41 215 1 ud. 40,94 €/ud	47 41 220 1 ud. 47,63 €/ud	47 41 230 1 ud. 54,04 €/ud	47 41 306 1 ud. 36,74 €/ud	47 41 310 1 ud. 38,29 €/ud	47 41 315 1 ud. 43,41 €/ud
Tapa cambio de nivel cóncavo	-	-	-	47 41 710 1 ud. 32,55 €/ud	47 41 715 1 ud. 34,79 €/ud	47 41 720 1 ud. 38,75 €/ud	47 41 730 1 ud. 54,66 €/ud	47 41 706 1 ud. 30,90 €/ud	47 41 710 1 ud. 32,55 €/ud	47 41 715 1 ud. 34,79 €/ud
Cambio de nivel convexo	-	-	-	47 51 210 1 ud. 36,74 €/ud	47 51 215 1 ud. 40,94 €/ud	47 51 220 1 ud. 47,63 €/ud	47 51 230 1 ud. 54,04 €/ud	47 51 306 1 ud. 36,74 €/ud	47 51 310 1 ud. 38,29 €/ud	47 51 315 1 ud. 43,41 €/ud
Tapa cambio de nivel convexo	-	-	-	47 51 710 1 ud. 32,55 €/ud	47 51 715 1 ud. 34,79 €/ud	47 51 720 1 ud. 38,75 €/ud	47 51 730 1 ud. 54,76 €/ud	47 51 706 1 ud. 30,90 €/ud	47 51 710 1 ud. 32,55 €/ud	47 51 715 1 ud. 34,79 €/ud

Código **XX XX XXX**
Embalaje 0 uds.
PVR 0,00 €/ud





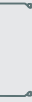
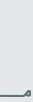
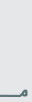
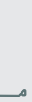
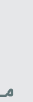



■ Longitud de las bandejas: 3 m.
Excepto las indicadas con (*) cuya longitud es de 2 m.
Longitud de tapas y tabiques: 2 m.

(1) Se suministran con 2 tornillos M6x12 con tuerca.
(2) Recomendable 1 unidad.

60x200	60x300	60x400	60x500	60x600	80x100	80x150	80x200	80x300	80x400	80x500	80x600
											
47 11 320 6 m. 21,58 €/m	47 11 330 6 m. 29,43 €/m	47 11 340 6 m. 42,85 €/m	47 11 350 6 m. 50,34 €/m	47 11 360 6 m. 57,49 €/m	47 11 410 6 m. 19,16 €/m	47 11 415 6 m. 21,53 €/m	47 11 420 6 m. 25,03 €/m	47 11 430 6 m. 32,79 €/m	47 11 440 6 m. 46,76 €/m	47 11 450 6 m. 53,73 €/m	47 11 460 6 m. 61,23 €/m
47 14 320 6 m. 21,58 €/m	47 14 330 6 m. 29,43 €/m	47 14 340 6 m. 42,85 €/m	47 14 350 6 m. 50,34 €/m	47 14 360 6 m. 57,49 €/m	47 14 410 6 m. 19,16 €/m	47 14 415 6 m. 21,53 €/m	47 14 420 6 m. 25,03 €/m	47 14 430 6 m. 32,79 €/m	47 14 440 6 m. 46,66 €/m	47 14 450 6 m. 53,73 €/m	47 14 460 6 m. 61,23 €/m
47 21 200 4 m. 12,76 €/m	47 21 300 4 m. 20,31 €/m	47 21 400 4 m. 26,35 €/m	47 21 500 4 m. 36,23 €/m	47 21 600 4 m. 42,54 €/m	47 21 100 4 m. 8,11 €/m	47 21 150 4 m. 10,33 €/m	47 21 200 4 m. 12,76 €/m	47 21 300 4 m. 20,31 €/m	47 21 400 4 m. 26,35 €/m	47 21 500 4 m. 36,23 €/m	47 21 600 4 m. 42,54 €/m
47 21 860 10 uds. 2,60 €/ud					47 21 880 10 uds. 4,15 €/ud						
-	(2)47 21 900 10 uds. 1,70 €/ud	(2)47 21 900 10 uds. 1,70 €/ud	-	-	-	-	-	(2)47 21 900 10 uds. 1,70 €/ud	(2)47 21 900 10 uds. 1,70 €/ud	-	-
-	-	-	(2)47 21 905 10 uds. 3,74 €/ud	(2)47 21 905 10 uds. 1,49 €/ud	-	-	-	-	-	(2)47 21 905 10 uds. 1,49 €/ud	(2)47 21 905 10 uds. 1,49 €/ud
47 21 960 1 ud. 17,54 €/ud					47 21 980 1 ud. 22,31 €/ud						
47 31 320 1 ud. 44,58 €/ud	47 31 330 1 ud. 51,51 €/ud	47 31 340 1 ud. 94,53 €/ud	47 31 350 1 ud. 132,44 €/ud	47 31 360 1 ud. 153,26 €/ud	47 31 410 1 ud. 40,06 €/ud	47 31 415 1 ud. 44,18 €/ud	47 31 420 1 ud. 50,20 €/ud	47 31 430 1 ud. 59,26 €/ud	47 31 440 1 ud. 110,91 €/ud	47 31 450 1 ud. 152,51 €/ud	47 31 460 1 ud. 157,71 €/ud
47 31 720 1 ud. 31,68 €/ud	47 31 730 1 ud. 45,09 €/ud	47 31 740 1 ud. 77,81 €/ud	47 31 750 1 ud. 88,44 €/ud	47 31 760 1 ud. 111,56 €/ud	47 31 710 1 ud. 26,21 €/ud	47 31 715 1 ud. 30,73 €/ud	47 31 720 1 ud. 31,68 €/ud	47 31 730 1 ud. 45,09 €/ud	47 31 740 1 ud. 77,81 €/ud	47 31 750 1 ud. 88,44 €/ud	47 31 760 1 ud. 111,56 €/ud
47 41 320 1 ud. 49,73 €/ud	47 41 330 1 ud. 58,01 €/ud	47 41 340 1 ud. 106,11 €/ud	47 41 350 1 ud. 148,60 €/ud	47 41 360 1 ud. 171,65 €/ud	47 41 410 1 ud. 44,00 €/ud	47 41 415 1 ud. 47,96 €/ud	47 41 420 1 ud. 54,35 €/ud	47 41 430 1 ud. 65,50 €/ud	47 41 440 1 ud. 118,86 €/ud	47 41 450 1 ud. 173,84 €/ud	47 41 460 1 ud. 175,04 €/ud
47 41 720 1 ud. 38,75 €/ud	47 41 730 1 ud. 54,66 €/ud	47 41 740 1 ud. 83,05 €/ud	47 41 750 1 ud. 121,43 €/ud	47 41 760 1 ud. 136,35 €/ud	47 41 710 1 ud. 32,55 €/ud	47 41 715 1 ud. 34,79 €/ud	47 41 720 1 ud. 38,75 €/ud	47 41 730 1 ud. 54,66 €/ud	47 41 740 1 ud. 83,05 €/ud	47 41 750 1 ud. 121,43 €/ud	47 41 760 1 ud. 136,35 €/ud
47 51 320 1 ud. 49,73 €/ud	47 51 330 1 ud. 58,01 €/ud	47 51 340 1 ud. 106,11 €/ud	47 51 350 1 ud. 148,60 €/ud	47 51 360 1 ud. 171,65 €/ud	47 51 410 1 ud. 44,00 €/ud	47 51 415 1 ud. 47,96 €/ud	47 51 420 1 ud. 54,35 €/ud	47 51 430 1 ud. 65,50 €/ud	47 51 440 1 ud. 118,86 €/ud	47 51 450 1 ud. 173,84 €/ud	47 51 460 1 ud. 175,04 €/ud
47 51 720 1 ud. 38,75 €/ud	47 51 730 1 ud. 54,76 €/ud	47 51 740 1 ud. 83,05 €/ud	47 51 750 1 ud. 121,43 €/ud	47 51 760 1 ud. 136,35 €/ud	47 51 710 1 ud. 32,55 €/ud	47 51 715 1 ud. 34,79 €/ud	47 51 720 1 ud. 38,75 €/ud	47 51 730 1 ud. 54,76 €/ud	47 51 740 1 ud. 83,05 €/ud	47 51 750 1 ud. 97,14 €/ud	47 51 760 1 ud. 109,08 €/ud

ACABADO SENDZIMIR										
Dimensiones (alto x ancho)	15x50	15x75	15x100	30x100	30x150	30x200	30x300	60x60	60x100	60x150
Bandejas										
Bandeja perforada	47 11 105	47 11 107	47 11 110	47 11 210	47 11 215	47 11 220	47 11 230	47 11 306	47 11 310	47 11 315
Bandeja ciega	-	-	-	47 14 210	47 14 215	47 14 220	47 14 230	47 14 306	47 14 310	47 14 315
Accesorios										
Derivación en "T"	-	-	-	47 61 210 1 ud. 40,00 €/ud	47 61 215 1 ud. 45,13 €/ud	47 61 220 1 ud. 53,53 €/ud	47 61 230 1 ud. 64,38 €/ud	47 61 306 1 ud. 40,66 €/ud	47 61 310 1 ud. 41,65 €/ud	47 61 315 1 ud. 46,98 €/ud
Tapa derivación en "T"	-	-	-	47 61 710 1 ud. 33,10 €/ud	47 61 715 1 ud. 38,09 €/ud	47 61 720 1 ud. 43,11 €/ud	47 61 730 1 ud. 60,01 €/ud	47 61 706 1 ud. 28,76 €/ud	47 61 710 1 ud. 33,10 €/ud	47 61 715 1 ud. 38,09 €/ud
Derivación semi "T"	-	-	-	47 61 510 1 ud. 27,28 €/ud	47 61 515 1 ud. 28,89 €/ud	47 61 520 1 ud. 32,48 €/ud	47 61 530 1 ud. 40,71 €/ud	47 61 606 1 ud. 27,18 €/ud	47 61 610 1 ud. 27,99 €/ud	47 61 615 1 ud. 30,69 €/ud
Tapa derivación semi "T"	-	-	-	47 61 910 1 ud. 25,11 €/ud	47 61 915 1 ud. 26,61 €/ud	47 61 920 1 ud. 28,30 €/ud	47 61 930 1 ud. 36,36 €/ud	47 61 906 1 ud. 23,18 €/ud	47 61 910 1 ud. 25,11 €/ud	47 61 915 1 ud. 26,61 €/ud
Derivación en cruz	-	-	-	47 71 210 1 ud. 46,48 €/ud	47 71 215 1 ud. 53,16 €/ud	47 71 220 1 ud. 63,70 €/ud	47 71 230 1 ud. 78,11 €/ud	47 71 306 1 ud. 48,40 €/ud	47 71 310 1 ud. 49,36 €/ud	47 71 315 1 ud. 56,31 €/ud
Tapa derivación en cruz	-	-	-	47 71 710 1 ud. 37,84 €/ud	47 71 715 1 ud. 43,64 €/ud	47 71 720 1 ud. 47,43 €/ud	47 71 730 1 ud. 58,68 €/ud	47 71 706 1 ud. 33,34 €/ud	47 71 710 1 ud. 37,84 €/ud	47 71 715 1 ud. 43,64 €/ud
Tapa final	-	-	-	47 81 930 1 ud. 4,73 €/ud	47 81 931 1 ud. 6,18 €/ud	47 81 932 1 ud. 7,28 €/ud	47 81 933 1 ud. 8,65 €/ud	47 81 950 1 ud. 3,95 €/ud	47 81 960 1 ud. 5,05 €/ud	47 81 961 1 ud. 6,50 €/ud
Juego de reducciones reducción de 50	-	-	-	-	47 81 520 1 ud. 23,68 €/ud	47 81 520 1 ud. 23,68 €/ud	-	-	-	47 81 525 1 ud. 25,26 €/ud
Juego de reducciones reducción de 100	-	-	-	-	-	47 81 521 1 ud. 26,84 €/ud	47 81 521 1 ud. 26,84 €/ud	-	-	-
Tabique separador	-	-	-	47 21 730 20 m. 6,60 €/m			-	-	-	-

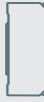
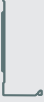
Código **XX XX XXX**
Embalaje 0 uds.
PVR 0,00 €/ud

60x200	60x300	60x400	60x500	60x600	80x100	80x150	80x200	80x300	80x400	80x500	80x600
											
47 11 320	47 11 330	47 11 340	47 11 350	47 11 360	47 11 410	47 11 415	47 11 420	47 11 430	47 11 440	47 11 450	47 11 460
47 14 320	47 14 330	47 14 340	47 14 350	47 14 360	47 14 410	47 14 415	47 14 420	47 14 430	47 14 440	47 14 450	47 14 460
47 61 320 1 ud. 55,16 €/ud	47 61 330 1 ud. 74,38 €/ud	47 61 340 1 ud. 112,01 €/ud	47 61 350 1 ud. 126,93 €/ud	47 61 360 1 ud. 147,43 €/ud	47 61 410 1 ud. 50,31 €/ud	47 61 415 1 ud. 55,33 €/ud	47 61 420 1 ud. 61,74 €/ud	47 61 430 1 ud. 82,86 €/ud	47 61 440 1 ud. 115,90 €/ud	47 61 450 1 ud. 137,43 €/ud	47 61 460 1 ud. 155,14 €/ud
47 61 720 1 ud. 43,11 €/ud	47 61 730 1 ud. 60,01 €/ud	47 61 740 1 ud. 67,15 €/ud	47 61 750 1 ud. 84,89 €/ud	47 61 760 1 ud. 113,83 €/ud	47 61 710 1 ud. 33,10 €/ud	47 61 715 1 ud. 38,09 €/ud	47 61 720 1 ud. 43,11 €/ud	47 61 730 1 ud. 60,01 €/ud	47 61 740 1 ud. 77,15 €/ud	47 61 750 1 ud. 84,89 €/ud	47 61 760 1 ud. 113,83 €/ud
47 61 620 1 ud. 33,39 €/ud	47 61 630 1 ud. 41,51 €/ud	-	-	-	47 61 810 1 ud. 35,98 €/ud	47 61 815 1 ud. 38,11 €/ud	47 61 820 1 ud. 41,41 €/ud	47 61 830 1 ud. 52,31 €/ud	-	-	-
47 61 920 1 ud. 28,30 €/ud	47 61 930 1 ud. 36,36 €/ud	-	-	-	47 61 910 1 ud. 25,11 €/ud	47 61 915 1 ud. 26,61 €/ud	47 61 920 1 ud. 28,30 €/ud	47 61 930 1 ud. 36,36 €/ud	-	-	-
47 71 320 1 ud. 67,54 €/ud	47 71 330 1 ud. 105,60 €/ud	47 71 340 1 ud. 123,81 €/ud	47 71 350 1 ud. 147,08 €/ud	47 71 360 1 ud. 163,68 €/ud	47 71 410 1 ud. 54,78 €/ud	47 71 415 1 ud. 62,71 €/ud	47 71 420 1 ud. 75,48 €/ud	47 71 430 1 ud. 117,88 €/ud	47 71 440 1 ud. 144,11 €/ud	47 71 450 1 ud. 185,85 €/ud	47 71 460 1 ud. 198,86 €/ud
47 71 720 1 ud. 47,43 €/ud	47 71 730 1 ud. 58,68 €/ud	47 71 740 1 ud. 80,99 €/ud	47 71 750 1 ud. 108,08 €/ud	47 71 760 1 ud. 111,81 €/ud	47 71 710 1 ud. 37,84 €/ud	47 71 715 1 ud. 43,64 €/ud	47 71 720 1 ud. 47,43 €/ud	47 71 730 1 ud. 58,68 €/ud	47 71 740 1 ud. 80,99 €/ud	47 71 750 1 ud. 108,08 €/ud	47 71 760 1 ud. 111,81 €/ud
47 81 962 1 ud. 7,59 €/ud	47 81 963 1 ud. 8,86 €/ud	47 81 964 1 ud. 9,61 €/ud	47 81 965 1 ud. 10,90 €/ud	47 81 966 1 ud. 11,53 €/ud	47 81 980 1 ud. 5,99 €/ud	47 81 981 1 ud. 7,28 €/ud	47 81 982 1 ud. 8,55 €/ud	47 81 983 1 ud. 9,61 €/ud	47 81 984 1 ud. 10,26 €/ud	47 81 985 1 ud. 11,08 €/ud	47 81 986 1 ud. 11,85 €/ud
47 81 525 1 ud. 25,26 €/ud	47 81 525 1 ud. 25,26 €/ud	47 81 525 1 ud. 25,26 €/ud	47 81 525 1 ud. 25,26 €/ud	47 81 525 1 ud. 25,26 €/ud	-	47 81 530 1 ud. 26,84 €/ud	47 81 530 1 ud. 26,84 €/ud	47 81 530 1 ud. 26,84 €/ud	47 81 530 1 ud. 26,84 €/ud	47 81 530 1 ud. 26,84 €/ud	47 81 530 1 ud. 26,84 €/ud
47 81 526 1 ud. 28,41 €/ud	47 81 526 1 ud. 28,41 €/ud	47 81 526 1 ud. 28,41 €/ud	47 81 526 1 ud. 28,41 €/ud	47 81 526 1 ud. 28,41 €/ud	-	-	47 81 531 1 ud. 29,98 €/ud	47 81 531 1 ud. 29,98 €/ud	47 81 531 1 ud. 29,98 €/ud	47 81 531 1 ud. 29,98 €/ud	47 81 531 1 ud. 29,98 €/ud
47 21 760 20 m. 8,05 €/m						47 21 780 20 m. 12,71 €/m					

ACABADO SENDZIMIR										
Dimensiones (alto x ancho)	15x50	15x75	15x100	30x100	30x150	30x200	30x300	60x60	60x100	60x150
Bandejas										
Bandeja perforada	47 11 105	47 11 107	47 11 110	47 11 210	47 11 215	47 11 220	47 11 230	47 11 306	47 11 310	47 11 315
Bandeja ciega	-	-	-	47 14 210	47 14 215	47 14 220	47 14 230	47 14 306	47 14 310	47 14 315
Soportería										
Soporte horizontal "FR"	-	-	45 51 110 10 ud. 7,58 €/ud	45 51 110 10 ud. 7,58 €/ud	45 51 115 10 ud. 8,72 €/ud	45 51 120 10 ud. 10,34 €/ud	45 51 130 10 ud. 12,80 €/ud	-	45 51 110 10 ud. 7,58 €/ud	45 51 115 10 ud. 8,72 €/ud
Consola "FR"	-	-	45 51 910 10 ud. 8,57 €/ud	45 51 910 10 ud. 8,57 €/ud	45 51 915 10 ud. 9,29 €/ud	45 51 920 10 ud. 10,46 €/ud	45 51 930 10 ud. 13,31 €/ud	-	45 51 910 10 ud. 8,57 €/ud	45 51 915 10 ud. 9,29 €/ud
Soporte omega horizontal "FR"	-	-	45 50 310 10 ud. 6,54 €/ud	45 50 310 10 ud. 6,54 €/ud	45 50 315 10 ud. 6,92 €/ud	45 50 320 10 ud. 8,27 €/ud	45 50 330 10 ud. 9,45 €/ud	-	45 50 310 10 ud. 6,54 €/ud	45 50 315 10 ud. 6,92 €/ud
Conjunto soporte horizontal "FR"	-	-	45 51 210 2 ud. 11,52 €/ud	45 51 210 2 ud. 11,52 €/ud	45 51 215 2 ud. 13,14 €/ud	45 51 220 2 ud. 15,17 €/ud	45 51 230 2 ud. 17,59 €/ud	-	45 51 210 2 ud. 11,52 €/ud	45 51 215 2 ud. 13,14 €/ud
Conjunto soporte orientable "FR"	-	-	45 51 510 2 ud. 17,78 €/ud	45 51 510 2 ud. 17,06 €/ud	45 51 515 2 ud. 18,96 €/ud	45 51 520 2 ud. 20,56 €/ud	45 51 530 2 ud. 28,06 €/ud	-	45 51 510 2 ud. 17,06 €/ud	45 51 515 2 ud. 18,96 €/ud
Soporte omega suspensión "FR"	-	-	45 50 410 4 ud. 11,65 €/ud	45 50 410 4 ud. 11,65 €/ud	45 50 415 4 ud. 12,51 €/ud	45 50 420 4 ud. 13,26 €/ud	45 50 430 4 ud. 15,23 €/ud	-	45 50 410 4 ud. 11,65 €/ud	45 50 415 4 ud. 12,51 €/ud
Soporte vertical suspensión "FR"	-	-	45 51 310 10 ud. 7,82 €/ud	45 51 310 10 ud. 7,82 €/ud	45 51 315 10 ud. 8,50 €/ud	45 51 320 10 ud. 9,06 €/ud	45 51 330 10 ud. 10,96 €/ud	-	45 51 310 10 ud. 7,82 €/ud	45 51 315 10 ud. 8,50 €/ud
Soporte suspensión reforzado	-	-	-	-	-	45 51 620 4 ud. 11,12 €/ud	45 51 630 4 ud. 12,02 €/ud	-	-	-

Soportería común a todas las dimensiones de bandejas

Soporte basculante	45 51 410 4 uds. 11,30 €/ud
Perfil en "U"	45 51 420 4 uds. 25,22 €/m
Soporte en "C"	45 51 440 10 uds. 4,15 €/ud

Soporte suspensión en "L"	45 51 450 10 uds. 4,15 €/ud
Tornillos de fijación M6x12	47 21 912 150/50 uds. 0,39 €/ud
Tornillos de fijación M6x20	45 71 110 150/50 uds. 0,44 €/ud

Tuercas reforzadas y con muelle	Ver pág. 56
Tuercas cuadradas	Ver pág. 56

Código	XX XX XXX
Embalaje	0 uds.
PVR	0,00 €/ud

60x200	60x300	60x400	60x500	60x600	80x100	80x150	80x200	80x300	80x400	80x500	80x600
47 11 320	47 11 330	47 11 340	47 11 350	47 11 360	47 11 410	47 11 415	47 11 420	47 11 430	47 11 440	47 11 450	47 11 460
47 14 320	47 14 330	47 14 340	47 14 350	47 14 360	47 14 410	47 14 415	47 14 420	47 14 430	47 14 440	47 14 450	47 14 460
45 51 120 10 ud. 10,34 €/ud	45 51 130 10 ud. 13,80 €/ud	45 51 140 5 ud. 18,91 €/ud	45 51 150 5 ud. 21,28 €/ud	45 51 160 5 ud. 24,26 €/ud	45 51 110 10 ud. 7,58 €/ud	45 51 115 10 ud. 8,72 €/ud	45 51 120 10 ud. 10,34 €/ud	45 51 130 10 ud. 13,80 €/ud	45 51 140 5 ud. 18,91 €/ud	45 51 150 5 ud. 21,28 €/ud	45 51 160 5 ud. 24,26 €/ud
45 51 920 10 ud. 10,46 €/ud	45 51 930 10 ud. 13,31 €/ud	45 51 940 4 ud. 16,03 €/ud	45 51 950 4 ud. 18,70 €/ud	45 51 960 4 ud. 23,27 €/ud	45 51 910 10 ud. 8,57 €/ud	45 51 915 10 ud. 9,29 €/ud	45 51 920 10 ud. 10,46 €/ud	45 51 930 10 ud. 13,31 €/ud	45 51 940 4 ud. 16,03 €/ud	45 51 950 4 ud. 18,70 €/ud	45 51 960 4 ud. 23,27 €/ud
45 50 320 10 ud. 8,27 €/ud	45 50 330 10 ud. 9,45 €/ud	-	-	-	45 50 310 10 ud. 6,54 €/ud	45 50 315 10 ud. 6,92 €/ud	45 50 320 10 ud. 8,27 €/ud	45 50 330 10 ud. 9,45 €/ud	-	-	-
45 51 220 2 ud. 15,17 €/ud	45 51 230 2 ud. 17,59 €/ud	45 51 240 2 ud. 20,34 €/ud	45 51 250 2 ud. 26,44 €/ud	45 51 260 2 ud. 31,66 €/ud	45 51 210 2 ud. 11,52 €/ud	45 51 215 2 ud. 13,14 €/ud	45 51 220 2 ud. 15,17 €/ud	45 51 230 2 ud. 17,59 €/ud	45 51 240 2 ud. 20,34 €/ud	45 51 250 2 ud. 26,44 €/ud	45 51 260 2 ud. 31,66 €/ud
45 51 520 2 ud. 20,56 €/ud	45 51 530 2 ud. 28,06 €/ud	45 51 540 2 ud. 32,51 €/ud	45 51 550 2 ud. 38,11 €/ud	45 51 560 2 ud. 42,12 €/ud	45 51 510 2 ud. 17,06 €/ud	45 51 515 2 ud. 18,96 €/ud	45 51 520 2 ud. 20,56 €/ud	45 51 530 2 ud. 28,06 €/ud	45 51 540 2 ud. 32,51 €/ud	45 51 550 2 ud. 38,11 €/ud	45 51 560 2 ud. 42,12 €/ud
45 50 420 4 ud. 13,26 €/ud	45 50 430 4 ud. 15,23 €/ud	-	-	-	45 50 410 4 ud. 11,65 €/ud	45 50 415 4 ud. 12,51 €/ud	45 50 420 4 ud. 13,26 €/ud	45 50 430 4 ud. 15,23 €/ud	-	-	-
45 51 320 10 ud. 9,06 €/ud	45 51 330 10 ud. 10,96 €/ud	45 51 340 5 ud. 12,78 €/ud	45 51 350 5 ud. 17,32 €/ud	45 51 360 5 ud. 20,31 €/ud	45 51 310 10 ud. 7,82 €/ud	45 51 315 10 ud. 8,50 €/ud	45 51 320 10 ud. 9,06 €/ud	45 51 330 10 ud. 10,96 €/ud	45 51 340 5 ud. 12,78 €/ud	45 51 350 5 ud. 17,32 €/ud	45 51 360 5 ud. 20,31 €/ud
45 51 620 4 ud. 11,12 €/ud	45 51 630 4 ud. 12,02 €/ud	45 51 640 4 ud. 15,06 €/ud	45 51 650 4 ud. 19,43 €/ud	45 51 660 4 ud. 21,74 €/ud	-	-	45 51 620 4 ud. 11,12 €/ud	45 51 630 4 ud. 12,02 €/ud	45 51 640 4 ud. 15,06 €/ud	45 51 650 4 ud. 19,43 €/ud	45 51 660 4 ud. 21,74 €/ud

	Ver pág. 52	
Conjunto varilla		
	45 71 408 10 uds. 17,80 €/ud	45 71 410 10 uds. 17,80 €/ud
Grapa tornillo viga		

	45 71 416 20 uds. 3,98 €/ud	45 71 418 20 uds. 3,83 €/ud
Grapa horizontal suspensión		
	45 71 436 20 uds. 4,76 €/ud	45 71 438 20 uds. 4,40 €/ud
Grapa horizontal suspensión		

	Ver pág. 55
Perfiles troquelados	
	47 21 910 25 uds. 1,28 €/ud
Fijación rápida metalnorma	

ACABADO GALVANIZADO CALIENTE										
Dimensiones (alto x ancho)	30x100	30x150	30x200	30x300	60x60	60x100	60x150	60x200	60x300	60x400
Bandejas										
Bandeja perforada	Consultar disponibilidad				47 12 306 8 m. 26,34 €/m	47 12 310 4 m. 29,46 €/m	47 12 315 4 m. 39,23 €/m	47 12 320 4 m. 41,43 €/m	47 12 330 4 m. 53,07 €/m	47 12 340 4 m. 101,06 €/m
Bandeja ciega	Consultar disponibilidad				47 12 606 8 m. 26,34 €/m	47 12 610 4 m. 29,46 €/m	47 12 615 4 m. 39,23 €/m	47 12 620 4 m. 41,43 €/m	47 12 630 4 m. 53,07 €/m	47 12 640 4 m. 101,06 €/m
Tapa										
Tapa para bandeja	Consultar disponibilidad				47 22 060 8 m. 13,14 €/m	47 22 100 4 m. 17,47 €/m	47 22 150 4 m. 23,05 €/m	47 22 200 4 m. 30,52 €/m	47 22 300 4 m. 44,92 €/m	47 22 400 4 m. 67,90 €/m
Uniones										
Brida de unión lateral (1)	47 22 830 10 uds. 6,60 €/ud				47 22 860 10 uds. 6,54 €/ud					
Brida de unión central (1)	-	-	-	Consultar disponibilidad	-	-	-	-	(2)47 22 900 10 uds. 3,65 €/ud	(2)47 22 900 10 uds. 3,65 €/ud
Brida de unión central doble (1)	-	-	-	Consultar disponibilidad	-	-	-	-	-	-
1 Multipieza (1)	Consultar disponibilidad				47 21 960 1 uds. 17,54 €/ud					
Accesorios										
Curva de 90°	Consultar disponibilidad				47 32 306 1 ud. 59,02 €/ud	47 32 310 1 ud. 60,24 €/ud	47 32 315 1 ud. 67,34 €/ud	47 32 320 1 ud. 76,98 €/ud	47 32 330 1 ud. 89,01 €/ud	47 32 340 1 ud. 135,00 €/ud
Tapa curva de 90°	-	-	-	-	47 32 706 1 ud. 24,64 €/ud	47 32 710 1 ud. 29,43 €/ud	47 32 715 1 ud. 40,55 €/ud	47 32 720 1 ud. 41,02 €/ud	47 32 730 1 ud. 49,92 €/ud	47 32 740 1 ud. 76,19 €/ud
Cambio de nivel cóncavo	Consultar disponibilidad				47 42 306 1 ud. 66,45 €/ud	47 42 310 1 ud. 69,39 €/ud	47 42 315 1 ud. 78,57 €/ud	47 42 320 1 ud. 90,03 €/ud	47 42 330 1 ud. 105,00 €/ud	47 42 340 1 ud. 192,17 €/ud
Tapa cambio de nivel cóncavo	-	-	-	-	47 42 706 1 ud. 53,45 €/ud	47 42 710 1 ud. 56,45 €/ud	47 42 715 1 ud. 60,23 €/ud	47 42 720 1 ud. 56,88 €/ud	47 42 730 1 ud. 94,62 €/ud	47 42 740 1 ud. 143,69 €/ud
Cambio de nivel convexo	Consultar disponibilidad				47 52 306 1 ud. 66,45 €/ud	47 52 310 1 ud. 69,39 €/ud	47 52 315 1 ud. 78,57 €/ud	47 52 320 1 ud. 90,03 €/ud	47 52 330 1 ud. 105,00 €/ud	47 52 340 1 ud. 192,17 €/ud
Tapa cambio de nivel convexo	-	-	-	-	47 52 706 1 ud. 53,45 €/ud	47 52 710 1 ud. 56,45 €/ud	47 52 715 1 ud. 60,23 €/ud	47 52 720 1 ud. 67,09 €/ud	47 52 730 1 ud. 94,62 €/ud	47 52 740 1 ud. 143,69 €/ud

Código **XX XX XXX**
Embalaje 0 uds.
PVR 0,00 €/ud







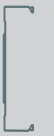

- Longitud de las bandejas, tapas y tabiques: 2 m.
- (1) Se suministran con 2 tornillos M6x12 con tuerca.
- (2) Recomendable 1 unidad.

1 Acabado sendzimir.

60x500	60x600	80x100	80x150	80x200	80x300	80x400	80x500	80x600
47 12 350 4 m. 113,83 €/m	47 12 360 4 m. 131,12 €/m	47 12 410 4 m. 38,21 €/m	47 12 415 4 m. 45,91 €/m	47 12 420 4 m. 51,21 €/m	47 12 430 4 m. 64,15 €/m	47 12 440 4 m. 107,47 €/m	47 12 450 4 m. 131,55 €/m	47 12 460 4 m. 143,20 €/m
47 12 650 4 m. 113,83 €/m	47 12 660 4 m. 131,12 €/m	47 12 810 4 m. 38,21 €/m	47 12 815 4 m. 45,91 €/m	47 12 820 4 m. 51,21 €/m	47 12 830 4 m. 64,15 €/m	47 12 840 4 m. 107,47 €/m	47 12 850 4 m. 131,55 €/m	47 12 860 4 m. 143,20 €/m
47 22 500 4 m. 85,96 €/m	47 22 600 4 m. 99,41 €/m	47 22 100 4 m. 17,47 €/m	47 22 150 4 m. 23,05 €/m	47 22 200 4 m. 30,52 €/m	47 22 300 4 m. 44,92 €/m	47 22 400 4 m. 67,90 €/m	47 22 500 4 m. 85,96 €/m	47 22 600 4 m. 99,41 €/m
47 22 880 10 uds. 7,09 €/ud								
-	-	-	-	-	(2)47 22 900 10 uds. 3,65 €/ud	(2)47 22 900 10 uds. 3,65 €/ud	-	-
(2)47 22 905 10 uds. 4,11 €/ud	(2)47 22 905 10 uds. 4,11 €/ud	-	-	-	-	-	(2)47 22 905 10 uds. 4,11 €/ud	(2)47 22 905 10 uds. 4,11 €/ud
47 21 980 10 uds. 22,31 €/ud								
47 32 350 1 ud. 152,03 €/ud	47 32 360 1 ud. 198,48 €/ud	47 32 410 1 ud. 73,38 €/ud	47 32 415 1 ud. 80,98 €/ud	47 32 420 1 ud. 92,05 €/ud	47 32 430 1 ud. 108,56 €/ud	47 32 440 1 ud. 152,38 €/ud	47 32 450 1 ud. 172,57 €/ud	47 32 460 1 ud. 224,85 €/ud
47 32 750 1 ud. 89,41 €/ud	47 32 760 1 ud. 104,43 €/ud	47 32 710 1 ud. 29,43 €/ud	47 32 715 1 ud. 40,55 €/ud	47 32 720 1 ud. 41,02 €/ud	47 32 730 1 ud. 49,92 €/ud	47 32 740 1 ud. 76,19 €/ud	47 32 750 1 ud. 89,41 €/ud	47 32 760 1 ud. 104,43 €/ud
47 42 350 1 ud. 269,12 €/ud	47 42 360 1 ud. 312,54 €/ud	47 42 410 1 ud. 79,57 €/ud	47 42 415 1 ud. 87,15 €/ud	47 42 420 1 ud. 98,42 €/ud	47 42 430 1 ud. 118,58 €/ud	47 42 440 1 ud. 214,87 €/ud	47 42 450 1 ud. 314,72 €/ud	47 42 460 1 ud. 317,58 €/ud
47 42 750 1 ud. 210,12 €/ud	47 42 760 1 ud. 236,41 €/ud	47 42 710 1 ud. 56,45 €/ud	47 42 715 1 ud. 60,23 €/ud	47 42 720 1 ud. 56,88 €/ud	47 42 730 1 ud. 94,62 €/ud	47 42 740 1 ud. 143,69 €/ud	47 42 750 1 ud. 210,12 €/ud	47 42 760 1 ud. 236,41 €/ud
47 52 350 1 ud. 269,12 €/ud	47 52 360 1 ud. 311,54 €/ud	47 52 410 1 ud. 79,57 €/ud	47 52 415 1 ud. 87,15 €/ud	47 52 420 1 ud. 98,42 €/ud	47 52 430 1 ud. 118,58 €/ud	47 52 440 1 ud. 214,87 €/ud	47 52 450 1 ud. 314,72 €/ud	47 52 460 1 ud. 317,58 €/ud
47 52 750 1 ud. 210,12 €/ud	47 52 760 1 ud. 236,41 €/ud	47 52 710 1 ud. 56,45 €/ud	47 52 715 1 ud. 60,23 €/ud	47 52 720 1 ud. 67,09 €/ud	47 52 730 1 ud. 94,62 €/ud	47 52 740 1 ud. 143,69 €/ud	47 52 750 1 ud. 210,12 €/ud	47 52 760 1 ud. 236,41 €/ud

ACABADO GALVANIZADO CALIENTE										
Dimensiones (alto x ancho)	30x100	30x150	30x200	30x300	60x60	60x100	60x150	60x200	60x300	60x400
										
Bandejas										
Bandeja perforada 	47 12 210	47 12 215	47 12 220	47 12 230	47 12 306	47 12 310	47 12 315	47 12 320	47 12 330	47 12 340
Bandeja ciega 	-	-	-	-	47 12 606	47 12 610	47 12 615	47 12 620	47 12 630	47 12 640
Accesorios										
Derivación en "T" 	Consultar disponibilidad				47 62 306 1 ud. 68,52 €/ud	47 62 310 1 ud. 70,24 €/ud	47 62 315 1 ud. 79,28 €/ud	47 62 320 1 ud. 93,04 €/ud	47 62 330 1 ud. 125,40 €/ud	47 62 340 1 ud. 188,34 €/ud
Tapa derivación en "T" 	Consultar disponibilidad				47 62 706 1 ud. 46,26 €/ud	47 62 710 1 ud. 53,38 €/ud	47 62 715 1 ud. 61,51 €/ud	47 62 720 1 ud. 69,61 €/ud	47 62 730 1 ud. 96,73 €/ud	47 62 740 1 ud. 124,44 €/ud
Derivación semi "T" 	Consultar disponibilidad				47 62 606 1 ud. 49,19 €/ud	47 62 610 1 ud. 51,64 €/ud	47 62 615 1 ud. 55,55 €/ud	47 62 620 1 ud. 60,44 €/ud	47 62 630 1 ud. 75,22 €/ud	-
Tapa derivación semi "T" 	Consultar disponibilidad				47 62 906 1 ud. 40,09 €/ud	47 62 910 1 ud. 43,48 €/ud	47 62 915 1 ud. 46,07 €/ud	47 62 920 1 ud. 49,05 €/ud	47 62 930 1 ud. 62,96 €/ud	-
Derivación en cruz 	Consultar disponibilidad				47 72 306 1 ud. 75,57 €/ud	47 72 310 1 ud. 77,05 €/ud	47 72 315 1 ud. 87,92 €/ud	47 72 320 1 ud. 105,44 €/ud	47 72 330 1 ud. 145,27 €/ud	47 72 340 1 ud. 193,30 €/ud
Tapa derivación en cruz 	Consultar disponibilidad				47 72 706 1 ud. 49,85 €/ud	47 72 710 1 ud. 56,45 €/ud	47 72 715 1 ud. 65,16 €/ud	47 72 720 1 ud. 70,82 €/ud	47 72 730 1 ud. 87,62 €/ud	47 72 740 1 ud. 120,92 €/ud
Tapa final 	Consultar disponibilidad				47 82 950 1 ud. 6,82 €/ud	47 82 960 1 ud. 8,72 €/ud	47 82 961 1 ud. 11,18 €/ud	47 82 962 1 ud. 13,11 €/ud	47 82 963 1 ud. 15,26 €/ud	47 82 964 1 ud. 16,62 €/ud
Juego de reducciones reducción de 50 	Consultar disponibilidad				-	-	47 82 525 1 ud. 43,59 €/ud	47 82 525 1 ud. 43,59 €/ud	47 82 525 1 ud. 43,59 €/ud	47 82 525 1 ud. 43,59 €/ud
Juego de reducciones reducción de 100 	Consultar disponibilidad				-	-	47 82 526 1 ud. 49,00 €/ud	47 82 526 1 ud. 49,00 €/ud	47 82 526 1 ud. 49,00 €/ud	47 82 526 1 ud. 49,00 €/ud
Tabique separador 	Consultar disponibilidad									47 22 760 20 m. 12,63 €/m

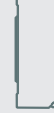
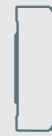
Código	XX XX XXX
Embalaje	0 uds.
PVR	0,00 €/ud

60x500	60x600	80x100	80x150	80x200	80x300	80x400	80x500	80x600
								
47 12 350	47 12 360	47 12 410	47 12 415	47 12 420	47 12 430	47 12 440	47 12 450	47 12 460
47 12 650	47 12 660	47 12 810	47 12 815	47 12 820	47 12 830	47 12 840	47 12 850	47 12 860
47 62 350 1 ud. 213,53 €/ud	47 62 360 1 ud. 248,72 €/ud	47 62 410 1 ud. 84,93 €/ud	47 62 415 1 ud. 93,64 €/ud	47 62 420 1 ud. 104,09 €/ud	47 62 430 1 ud. 139,76 €/ud	47 62 440 1 ud. 194,94 €/ud	47 62 450 1 ud. 231,12 €/ud	47 62 460 1 ud. 261,64 €/ud
47 62 750 1 ud. 136,93 €/ud	47 62 760 1 ud. 183,60 €/ud	47 62 710 1 ud. 53,38 €/ud	47 62 715 1 ud. 61,51 €/ud	47 62 720 1 ud. 69,61 €/ud	47 62 730 1 ud. 96,73 €/ud	47 62 740 1 ud. 124,44 €/ud	47 62 750 1 ud. 136,93 €/ud	47 62 760 1 ud. 183,60 €/ud
-	-	47 62 810 1 ud. 65,14 €/ud	47 62 815 1 ud. 69,12 €/ud	47 62 820 1 ud. 75,01 €/ud	47 62 830 1 ud. 94,81 €/ud	-	-	-
-	-	47 62 910 1 ud. 43,48 €/ud	47 62 915 1 ud. 46,07 €/ud	47 62 920 1 ud. 49,05 €/ud	47 62 930 1 ud. 62,96 €/ud	-	-	-
47 72 350 1 ud. 229,68 €/ud	47 72 360 1 ud. 255,56 €/ud	47 72 410 1 ud. 85,49 €/ud	47 72 415 1 ud. 97,87 €/ud	47 72 420 1 ud. 117,83 €/ud	47 72 430 1 ud. 184,05 €/ud	47 72 440 1 ud. 225,06 €/ud	47 72 450 1 ud. 290,23 €/ud	47 72 460 1 ud. 310,51 €/ud
47 72 750 1 ud. 161,03 €/ud	47 72 760 1 ud. 166,93 €/ud	47 72 710 1 ud. 56,45 €/ud	47 72 715 1 ud. 65,16 €/ud	47 72 720 1 ud. 70,82 €/ud	47 72 730 1 ud. 87,62 €/ud	47 72 740 1 ud. 120,92 €/ud	47 72 750 1 ud. 161,03 €/ud	47 72 760 1 ud. 166,93 €/ud
47 82 965 1 ud. 18,79 €/ud	47 82 966 1 ud. 19,87 €/ud	47 82 980 1 ud. 10,36 €/ud	47 82 981 1 ud. 12,56 €/ud	47 82 982 1 ud. 14,71 €/ud	47 82 983 1 ud. 16,72 €/ud	47 82 984 1 ud. 17,71 €/ud	47 82 985 1 ud. 19,06 €/ud	47 82 986 1 ud. 20,41 €/ud
47 82 525 1 ud. 43,59 €/ud	47 82 525 1 ud. 43,59 €/ud	-	47 82 530 1 ud. 46,28 €/ud	47 82 530 1 ud. 46,28 €/ud	47 82 530 1 ud. 46,28 €/ud	47 82 530 1 ud. 46,28 €/ud	47 82 530 1 ud. 46,28 €/ud	47 82 530 1 ud. 46,28 €/ud
47 82 526 1 ud. 49,00 €/ud	47 82 526 1 ud. 49,00 €/ud	-	47 82 531 1 ud. 51,70 €/ud	47 82 531 1 ud. 51,70 €/ud	47 82 531 1 ud. 51,70 €/ud	47 82 531 1 ud. 51,70 €/ud	47 82 531 1 ud. 51,70 €/ud	47 82 531 1 ud. 51,70 €/ud
47 22 780 20 m. 17,65 €/m								

ACABADO GALVANIZADO CALIENTE										
Dimensiones (alto x ancho)	30x100	30x150	30x200	30x300	60x60	60x100	60x150	60x200	60x300	60x400
Bandejas										
Bandeja perforada	47 12 210	47 12 215	47 12 220	47 12 230	47 12 306	47 12 310	47 12 315	47 12 320	47 12 330	47 12 340
Bandeja ciega	-	-	-	-	47 12 606	47 12 610	47 12 615	47 12 620	47 12 630	47 12 640
Soportería										
Soporte horizontal "FR"	Consultar disponibilidad				-	45 52 110 10 ud. 10,33 €/ud	45 52 115 10 ud. 11,28 €/ud	45 52 120 10 ud. 12,63 €/ud	45 52 130 10 ud. 18,89 €/ud	45 52 140 5 ud. 25,28 €/ud
Consola "FR"	Consultar disponibilidad				-	45 52 910 10 ud. 11,87 €/ud	45 52 915 10 ud. 12,95 €/ud	45 52 920 10 ud. 14,51 €/ud	45 52 930 10 ud. 17,71 €/ud	45 52 940 4 ud. 21,54 €/ud
1 Soporte omega horizontal "FR"	Consultar disponibilidad				-	45 50 310 10 ud. 7,11 €/ud	45 50 315 10 ud. 7,53 €/ud	45 50 320 10 ud. 8,99 €/ud	45 50 330 10 ud. 10,28 €/ud	-
Conjunto soporte horizontal "FR"	Consultar disponibilidad				-	Consultar disponibilidad				
Conjunto soporte orientable "FR"	Consultar disponibilidad				-	Consultar disponibilidad				
1 Soporte omega suspensión "FR"	Consultar disponibilidad				-	45 50 410 4 ud. 12,66 €/ud	45 50 415 4 ud. 13,60 €/ud	45 50 420 4 ud. 14,41 €/ud	45 50 430 4 ud. 16,55 €/ud	-
Soporte vertical suspensión "FR"	Consultar disponibilidad				-	45 52 310 10 ud. 10,60 €/ud	45 52 315 10 ud. 11,66 €/ud	45 52 320 10 ud. 12,18 €/ud	45 52 330 10 ud. 14,81 €/ud	45 52 340 5 ud. 17,68 €/ud
1 Soporte suspensión reforzado	Consultar disponibilidad				-	-	-	45 51 620 4 ud. 11,59 €/ud	45 51 630 4 ud. 12,53 €/ud	45 51 640 4 ud. 15,69 €/ud

Soportería común a todas las dimensiones de bandejas

Soporte basculante	45 52 410 4 uds. 16,80 €/ud
Perfil en "U"	45 52 420 4 m. 35,20 €/m
Soporte en "C"	45 52 440 10 uds. 6,89 €/ud

Soporte suspensión en "L"	45 52 450 10 uds. 6,89 €/ud
1 Tornillos de fijación M6x12	47 21 912 150/50 uds. 0,39 €/ud
1 Tornillos de fijación M6x20	45 71 110 150/50 uds. 0,44 €/ud

Tuercas reforzadas y con muelle	Ver pág. 56
Tuercas cuadradas	Ver pág. 56
1 Conjunto varilla	Ver pág. 52

Código	XX XX XXX
Embalaje	0 uds.
PVR	0,00 €/ud

1 Acabado sendzimir.

60x500	60x600	80x100	80x150	80x200	80x300	80x400	80x500	80x600
47 12 350	47 12 360	47 12 410	47 12 415	47 12 420	47 12 430	47 12 440	47 12 450	47 12 460
47 12 650	47 12 660	47 12 810	47 12 815	47 12 820	47 12 830	47 12 840	47 12 850	47 12 860
45 52 150 5 ud. 30,69 €/ud	45 52 160 5 ud. 33,95 €/ud	45 52 110 10 ud. 10,33 €/ud	45 52 115 10 ud. 11,28 €/ud	45 52 120 10 ud. 12,63 €/ud	45 52 130 10 ud. 18,89€/ud	45 52 140 5 ud. 25,28 €/ud	45 52 150 5 ud. 30,69 €/ud	45 52 160 5 ud. 33,95 €/ud
45 52 950 4 ud. 27,90 €/ud	45 52 960 4 ud. 31,21 €/ud	45 52 910 10 ud. 11,87 €/ud	45 52 915 10 ud. 12,95 €/ud	45 52 920 10 ud. 14,51 €/ud	45 52 930 10 ud. 17,71 €/ud	45 52 940 4 ud. 21,54 €/ud	45 52 950 4 ud. 27,90 €/ud	45 52 960 4 ud. 31,21 €/ud
-	-	45 50 310 10 ud. 7,11 €/ud	45 50 315 10 ud. 7,53 €/ud	45 50 320 10 ud. 8,99 €/ud	45 50 330 10 ud. 10,28 €/ud	-	-	-
Consultar disponibilidad								
Consultar disponibilidad								
-	-	45 50 410 4 ud. 12,66 €/ud	45 50 415 4 ud. 13,60 €/ud	45 50 420 4 ud. 14,41 €/ud	45 50 430 4 ud. 16,55 €/ud	-	-	-
45 52 350 5 ud. 21,29 €/ud	45 52 360 5 ud. 25,16 €/ud	45 52 310 10 ud. 10,60 €/ud	45 52 315 10 ud. 11,66 €/ud	45 52 320 10 ud. 12,18 €/ud	45 52 330 10 ud. 14,81 €/ud	45 52 340 5 ud. 17,68 €/ud	45 52 350 5 ud. 21,29 €/ud	45 52 360 5 ud. 25,16 €/ud
45 51 650 4 ud. 20,24 €/ud	45 51 660 4 ud. 22,65 €/ud	-	-	45 51 620 4 ud. 11,59 €/ud	45 51 630 4 ud. 12,53 €/ud	45 51 640 4 ud. 15,69 €/ud	45 51 650 4 ud. 20,24 €/ud	45 51 660 4 ud. 22,65 €/ud

1 Grapa tornillo viga	45 71 408 10 uds. 17,80 €/ud	45 71 410 10 uds. 17,80 €/ud
1 Grapa horizontal suspensión	45 71 416 20 uds. 3,98 €/ud	45 71 418 20 uds. 3,83 €/ud
1 Grapa horizontal suspensión	45 71 436 20 uds. 4,76 €/ud	45 71 438 20 uds. 4,40 €/ud

Perfiles troquelados	Ver pág. 55
Fijación rápida metalnorma	47 21 910 25 uds. 1,28 €/ud

BANDEJA PERFORADA



Bandeja perforada	SENDZIMIR			GALV. CALIENTE			Dimensiones (mm)	
	Ref.	P.V.R. €/m	M.Emb.	Ref.	P.V.R. €/m	M.Emb.	A	B
15x50*	47 11 105	7,13	16	-	-	-	15	50
15x75*	47 11 107	9,59	16	-	-	-	15	75
15x100*	47 11 110	10,60	16	-	-	-	15	100
30x100	47 11 210	11,27	12	**			30	100
30x150	47 11 215	14,27	6	**			30	150
30x200	47 11 220	19,14	6	**			30	200
30x300	47 11 230	24,98	6	**			30	300
60x60	47 11 306	11,81	12	47 12 306	26,34	8	60	60
60x100	47 11 310	14,34	6	47 12 310	29,46	4	60	100
60x150	47 11 315	18,69	6	47 12 315	39,23	4	60	150
60x200	47 11 320	21,58	6	47 12 320	41,43	4	60	200
60x300	47 11 330	29,43	6	47 12 330	53,07	4	60	300
60x400	47 11 340	42,85	6	47 12 340	101,06	4	60	400
60x500	47 11 350	50,34	6	47 12 350	113,83	4	60	500
60x600	47 11 360	57,49	6	47 12 360	131,12	4	60	600
80x100	47 11 410	19,16	6	47 12 410	38,21	4	80	100
80x150	47 11 415	21,53	6	47 12 415	45,91	4	80	150
80x200	47 11 420	25,03	6	47 12 420	51,21	4	80	200
80x300	47 11 430	32,79	6	47 12 430	64,15	4	80	300
80x400	47 11 440	46,66	6	47 12 440	107,47	4	80	400
80x500	47 11 450	53,73	6	47 12 450	131,55	4	80	500
80x600	47 11 460	61,23	6	47 12 460	143,20	4	80	600

- Longitud bandeja acabado sendzimir: 3 m. Excepto (*) de longitud de 2 m.
- Longitud bandeja acabado galvanizado caliente: 2 m.
- ** Consultar disponibilidad.

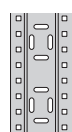
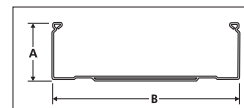

Bandejas perforadas de 100

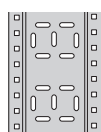

Bandejas perforadas de 150

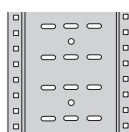

Bandejas perforadas de 200



Bandejas perforadas de 300

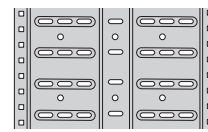

Bandejas perforadas de 400/500/600

BANDEJA CIEGA

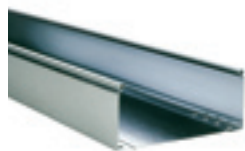

Bandeja ciega	SENDZIMIR			GALV. CALIENTE			Dimensiones (mm)	
	Ref.	P.V.R. €/m	M.Emb.	Ref.	P.V.R. €/m	M.Emb.	A	B
30x100	47 14 210	11,27	12	-	-	-	30	100
30x150	47 14 215	14,27	6	-	-	-	30	150
30x200	47 14 220	19,14	6	-	-	-	30	200
30x300	47 14 230	24,98	6	-	-	-	30	300
60x60	47 14 306	11,81	12	47 12 606	26,34	8	60	60
60x100	47 14 310	14,34	6	47 12 610	29,46	4	60	100
60x150	47 14 315	18,69	6	47 12 615	39,23	4	60	150
60x200	47 14 320	21,58	6	47 12 620	41,43	4	60	200
60x300	47 14 330	29,43	6	47 12 630	53,07	4	60	300
60x400	47 14 340	42,85	6	47 12 640	101,06	4	60	400
60x500	47 14 350	50,34	6	47 12 650	113,83	4	60	500
60x600	47 14 360	57,49	6	47 12 660	131,12	4	60	600
80x100	47 14 410	19,16	6	47 12 810	38,21	4	80	100
80x150	47 14 415	21,53	6	47 12 815	45,91	4	80	150
80x200	47 14 420	25,03	6	47 12 820	51,21	4	80	200
80x300	47 14 430	32,79	6	47 12 830	64,15	4	80	300
80x400	47 14 440	46,66	6	47 12 840	107,47	4	80	400
80x500	47 14 450	53,73	6	47 12 850	131,55	4	80	500
80x600	47 14 460	61,23	6	47 12 860	143,20	4	80	600

- Longitud bandeja acabado sendzimir: 3 m.
- Longitud bandeja acabado galvanizado caliente: 2 m.

TAPA PARA BANDEJA



Tapa bandeja	SENDZIMIR			GALV. CALIENTE			Dimensiones (mm)	
	Ref.	P.V.R. €/m	M.Emb.	Ref.	P.V.R. €/m	M.Emb.	A	B
60	47 21 060	6,36		47 22 060	13,14	8	12	60
100	47 21 100	8,11		47 22 100	17,47	4	12	100
150	47 21 150	10,33		47 22 150	23,05	4	12	150
200	47 21 200	12,76		47 22 200	30,52	4	12	200
300	47 21 300	20,31		47 22 300	44,92	4	12	300
400	47 21 400	26,35		47 22 400	67,90	4	12	400
500	47 21 500	36,23		47 22 500	85,96	4	12	500
600	47 21 600	42,54		47 22 600	99,41	4	12	600

- Longitud tapa acabado sendzimir: 2 m.
- Longitud tapa acabado galvanizado caliente: 2 m.

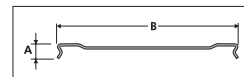

TABIQUE SEPARADOR



Tabique separador	SENDZIMIR			GALV. CALIENTE			Dimensiones (mm)	
	Ref.	P.V.R. €/m	M.Emb.	Ref.	P.V.R. €/m	M.Emb.	A	B
Ala 30	47 21 730	6,60		*		20	25	17
Ala 60	47 21 760	8,05		47 22 760	12,63	20	55	17
Ala 80	47 21 780	12,71		47 22 780	17,65	20	75	17

- Longitud tabique acabado sendzimir: 2 m.
- Longitud tabique acabado galvanizado caliente: 2 m.
- * Consultar disponibilidad.

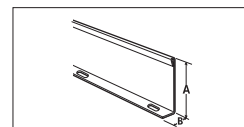

BRIDA DE UNIÓN LATERAL



47 21 8X0

Brida de unión lateral

	SENDZIMIR		GALV. CALIENTE		M. Emb.
	Ref.	P.V.R. €/ud	Ref.	P.V.R. €/ud	
Para ala de 30	47 21 830	1,97	47 22 830	6,60	10
Para ala de 60	47 21 860	2,60	47 22 860	6,54	10
Para ala de 80	47 21 880	4,15	47 22 880	7,09	10

Dimensiones (mm)				
A	B	C	E	
27	100	23	1	
57	150	23	1	
77	200	23	1	

- Se suministra con dos tornillos M6x12 con tuerca.
- * Consultar disponibilidad.

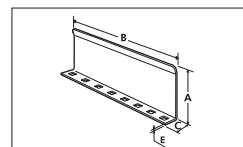

BRIDA DE UNIÓN CENTRAL



47 21 900

	SENDZIMIR		GALV. CALIENTE		M.Emb.
	Ref.	P.V.R. €/ud	Ref.	P.V.R. €/ud	
Brida de unión central	47 21 900	1,70	47 22 900	3,65	10

Dimensiones (mm)		
A	B	E
75	40	1

- Se suministra con dos tornillos M6x12 con tuerca.
- Complemento recomendado a las bridas de unión lateral para bandejas de ancho 300 y 400.

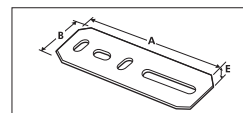

BRIDA DE UNIÓN CENTRAL DOBLE



47 21 905

	SENDZIMIR		GALV. CALIENTE		M.Emb.
	Ref.	P.V.R. €/ud	Ref.	P.V.R. €/ud	
Brida de unión central doble	47 21 905	3,74	47 22 905	4,11	10

Dimensiones (mm)		
A	B	E
150	140	1,5

- Se suministra con dos tornillos M6x12 con tuerca.
- Complemento recomendado a las bridas de unión lateral para bandejas de ancho 500 y 600.

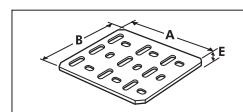

MULTIPIEZA



47 21 9X0

	SENDZIMIR		
	Ref.	P.V.R. €/ud	M.Emb.
Para ala de 30	47 21 930	14,34	1
Para ala de 60	47 21 960	17,54	1
Para ala de 80	47 21 980	22,31	1

Dimensiones de ala (mm)	
	A
	30
	60
	80

- Se suministra con dos tornillos M6x12 con tuerca.

CURVA Y TAPA DE 90°

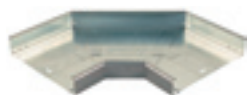

47 31 XXX

Curva de 90°	SENDZIMIR		GALV. CALIENTE		M.Emb.	Dimensiones (mm)		
	Ref.	P.V.R. €/ud	Ref.	P.V.R. €/ud		A	B	R
Para bandeja 30x100	47 31 210	33,41	*		1	30	100	190
Para bandeja 30x150	47 31 215	37,30	*		1	30	150	190
Para bandeja 30x200	47 31 220	42,76	*		1	30	200	190
Para bandeja 30x300	47 31 230	49,58	*		1	30	300	190
Para bandeja 60x60	47 31 306	34,18	47 32 306	59,02	1	60	60	190
Para bandeja 60x100	47 31 310	34,81	47 32 310	60,24	1	60	100	190
Para bandeja 60x150	47 31 315	38,99	47 32 315	67,34	1	60	150	190
Para bandeja 60x200	47 31 320	44,58	47 32 320	76,98	1	60	200	190
Para bandeja 60x300	47 31 330	51,51	47 32 330	89,01	1	60	300	190
Para bandeja 60x400	47 31 340	94,53	47 32 340	135,00	1	60	400	190
Para bandeja 60x500	47 31 350	132,44	47 32 350	152,03	1	60	500	190
Para bandeja 60x600	47 31 360	153,26	47 32 360	198,48	1	60	600	190
Para bandeja 80x100	47 31 410	40,06	47 32 410	73,38	1	80	100	190
Para bandeja 80x150	47 31 415	44,18	47 32 415	80,98	1	80	150	190
Para bandeja 80x200	47 31 420	50,20	47 32 420	92,01	1	80	200	190
Para bandeja 80x300	47 31 430	59,26	47 32 430	108,56	1	80	300	190
Para bandeja 80x400	47 31 440	110,91	47 32 440	152,38	1	80	400	190
Para bandeja 80x500	47 31 450	152,51	47 32 450	172,57	1	80	500	190
Para bandeja 80x600	47 31 460	157,71	47 32 460	224,85	1	80	600	190

* Consultar disponibilidad.

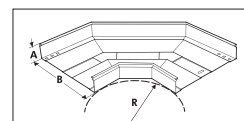

47 31 7XX

Tapa curva de 90°	SENDZIMIR		GALV. CALIENTE		M.Emb.	Dimensiones (mm)		
	Ref.	P.V.R. €/ud	Ref.	P.V.R. €/ud		A	B	R
Para bandeja ancho 60	47 31 706	17,06	47 32 706	24,64	1	12	60	190
Para bandeja ancho 100	47 31 710	26,21	47 32 710	29,43	1	12	100	190
Para bandeja ancho 150	47 31 715	30,73	47 32 715	40,55	1	12	150	190
Para bandeja ancho 200	47 31 720	31,68	47 32 720	41,02	1	12	200	190
Para bandeja ancho 300	47 31 730	45,09	47 32 730	49,92	1	12	300	190
Para bandeja ancho 400	47 31 740	77,81	47 32 740	76,19	1	12	400	190
Para bandeja ancho 500	47 31 750	88,44	47 32 750	89,41	1	12	500	190
Para bandeja ancho 600	47 31 760	111,56	47 32 760	104,43	1	12	600	190

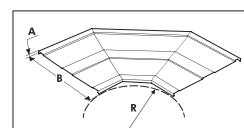

CAMBIO DE NIVEL CÓNCAVO Y TAPA

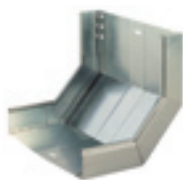

47 41 XXX

Cambio de nivel cóncavo	SENDZIMIR		GALV. CALIENTE		M.Emb.	Dimensiones (mm)	
	Ref.	P.V.R. €/ud	Ref.	P.V.R. €/ud		A	B
Para bandeja 30x100	47 41 210	36,74	*		1	30	100
Para bandeja 30x150	47 41 215	40,94	*		1	30	150
Para bandeja 30x200	47 41 220	47,63	*		1	30	200
Para bandeja 30x300	47 41 230	54,04	*		1	30	300
Para bandeja 60x60	47 41 306	36,74	47 42 306	66,45	1	60	60
Para bandeja 60x100	47 41 310	38,29	47 42 310	69,39	1	60	100
Para bandeja 60x150	47 41 315	43,41	47 42 315	78,57	1	60	150
Para bandeja 60x200	47 41 320	49,73	47 42 320	90,03	1	60	200
Para bandeja 60x300	47 41 330	58,01	47 42 330	105,00	1	60	300
Para bandeja 60x400	47 41 340	106,11	47 42 340	192,17	1	60	400
Para bandeja 60x500	47 41 350	148,60	47 42 350	269,12	1	60	500
Para bandeja 60x600	47 41 360	171,65	47 42 360	311,54	1	60	600
Para bandeja 80x100	47 41 410	44,00	47 42 410	79,57	1	80	100
Para bandeja 80x150	47 41 415	47,96	47 42 415	87,15	1	80	150
Para bandeja 80x200	47 41 420	54,35	47 42 420	98,42	1	80	200
Para bandeja 80x300	47 41 430	65,50	47 42 430	118,58	1	80	300
Para bandeja 80x400	47 41 440	118,86	47 42 440	214,87	1	80	400
Para bandeja 80x500	47 41 450	173,84	47 42 450	314,72	1	80	500
Para bandeja 80x600	47 41 460	175,04	47 42 460	317,58	1	80	600

* Consultar disponibilidad.

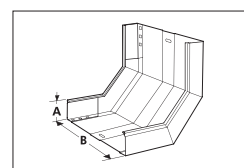

47 41 TXX

Tapa cambio de nivel cóncavo	SENDZIMIR		GALV. CALIENTE		M.Emb.	Dimensiones (mm)	
	Ref.	P.V.R. €/ud	Ref.	P.V.R. €/ud		A	B
Para bandeja ancho 60	47 41 706	30,90	47 42 706	53,45	1	12	60
Para bandeja ancho 100	47 41 710	32,55	47 42 710	56,45	1	12	100
Para bandeja ancho 150	47 41 715	34,79	47 42 715	60,23	1	12	150
Para bandeja ancho 200	47 41 720	38,75	47 42 720	56,88	1	12	200
Para bandeja ancho 300	47 41 730	54,66	47 42 730	94,62	1	12	300
Para bandeja ancho 400	47 41 740	83,05	47 42 740	143,69	1	12	400
Para bandeja ancho 500	47 41 750	121,43	47 42 750	210,12	1	12	500
Para bandeja ancho 600	47 41 760	136,35	47 42 760	236,41	1	12	600

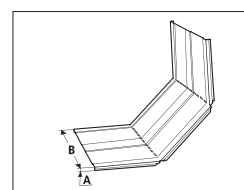

CAMBIO DE NIVEL CONVEXO Y TAPA

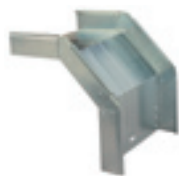

47 51 XXX

Cambio de nivel convexo	SENDZIMIR		GALV. CALIENTE		M.Emb.	Dimensiones (mm)	
	Ref.	P.V.R. €/ud	Ref.	P.V.R. €/ud		A	B
Para bandeja 30x100	47 51 210	36,74	*		1	30	100
Para bandeja 30x150	47 51 215	40,94	*		1	30	150
Para bandeja 30x200	47 51 220	47,63	*		1	30	200
Para bandeja 30x300	47 51 230	54,04	*		1	30	300
Para bandeja 60x60	47 51 306	36,74	47 52 306	66,45	1	60	60
Para bandeja 60x100	47 51 310	38,29	47 52 310	69,39	1	60	100
Para bandeja 60x150	47 51 315	43,41	47 52 315	78,57	1	60	150
Para bandeja 60x200	47 51 320	49,73	47 52 320	90,03	1	60	200
Para bandeja 60x300	47 51 330	58,01	47 52 330	105,00	1	60	300
Para bandeja 60x400	47 51 340	106,11	47 52 340	192,17	1	60	400
Para bandeja 60x500	47 51 350	148,60	47 52 350	269,12	1	60	500
Para bandeja 60x600	47 51 360	171,65	47 52 360	311,54	1	60	600
Para bandeja 80x100	47 51 410	44,00	47 52 410	79,57	1	80	100
Para bandeja 80x150	47 51 415	47,96	47 52 415	87,15	1	80	150
Para bandeja 80x200	47 51 420	54,35	47 52 420	98,42	1	80	200
Para bandeja 80x300	47 51 430	65,50	47 52 430	118,58	1	80	300
Para bandeja 80x400	47 51 440	118,86	47 52 440	214,87	1	80	400
Para bandeja 80x500	47 51 450	173,84	47 52 450	314,72	1	80	500
Para bandeja 80x600	47 51 460	175,04	47 52 460	317,58	1	80	600

* Consultar disponibilidad.

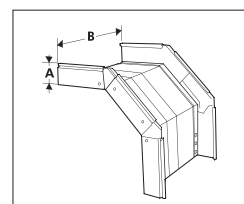

47 51 7XX

Tapa cambio de nivel convexo	SENDZIMIR		GALV. CALIENTE		M.Emb.	Dimensiones (mm)	
	Ref.	P.V.R. €/ud	Ref.	P.V.R. €/ud		A	B
Para bandeja ancho 60	47 51 706	30,90	47 52 706	53,45	1	12	60
Para bandeja ancho 100	47 51 710	32,55	47 52 710	56,45	1	12	100
Para bandeja ancho 150	47 51 715	34,79	47 52 715	60,23	1	12	150
Para bandeja ancho 200	47 51 720	38,75	47 52 720	67,09	1	12	200
Para bandeja ancho 300	47 51 730	54,66	47 52 730	94,62	1	12	300
Para bandeja ancho 400	47 51 740	83,05	47 52 740	143,69	1	12	400
Para bandeja ancho 500	47 51 750	121,43	47 52 750	210,12	1	12	500
Para bandeja ancho 600	47 51 760	136,35	47 52 760	236,41	1	12	600

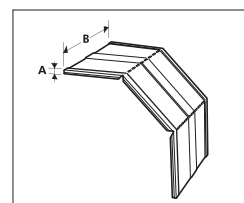

DERIVACIÓN Y TAPA EN "T"



47 61 XXX

Derivación en "T"	SENDZIMIR		GALV. CALIENTE		U.Emb.	Dimensiones (mm)			
	Ref.	P.V.R. €/ud	Ref.	P.V.R. €/ud		A	B	C	D
Para bandeja 30x100	47 61 210	40,00	*		1	30	100	528	320
Para bandeja 30x150	47 61 215	45,13	*		1	30	150	578	370
Para bandeja 30x200	47 61 220	53,53	*		1	30	200	628	420
Para bandeja 30x300	47 61 230	64,38	*		1	30	300	728	520
Para bandeja 60x60	47 61 306	40,66	47 62 306	68,52	1	60	60	487,5	285
Para bandeja 60x100	47 61 310	41,65	47 62 310	70,24	1	60	100	528	320
Para bandeja 60x150	47 61 315	46,98	47 62 315	79,28	1	60	150	578	370
Para bandeja 60x200	47 61 320	55,16	47 62 320	93,04	1	60	200	628	420
Para bandeja 60x300	47 61 330	74,38	47 62 330	125,40	1	60	300	728	520
Para bandeja 60x400	47 61 340	112,01	47 62 340	188,34	1	60	400	828	620
Para bandeja 60x500	47 61 350	126,93	47 62 350	213,53	1	60	500	928	720
Para bandeja 60x600	47 61 360	147,43	47 62 360	248,72	1	60	600	1028	820
Para bandeja 80x100	47 61 410	50,31	47 62 410	84,93	1	80	100	528	320
Para bandeja 80x150	47 61 415	55,33	47 62 415	93,64	1	80	150	578	370
Para bandeja 80x200	47 61 420	61,74	47 62 420	104,09	1	80	200	628	420
Para bandeja 80x300	47 61 430	82,86	47 62 430	139,76	1	80	300	728	520
Para bandeja 80x400	47 61 440	115,90	47 62 440	194,94	1	80	400	828	620
Para bandeja 80x500	47 61 450	137,43	47 62 450	231,12	1	80	500	928	720
Para bandeja 80x600	47 61 460	155,14	47 62 460	261,64	1	80	600	1028	820

* Consultar disponibilidad.

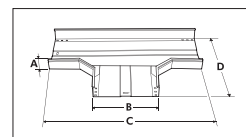

47 61 7XX

Tapa derivación en "T"	SENDZIMIR		GALV. CALIENTE		U.Emb.	Dimensiones (mm)	
	Ref.	P.V.R. €/ud	Ref.	P.V.R. €/ud		A	B
Para bandeja ancho 60	47 61 706	28,76	47 62 706	46,26	1	12	60
Para bandeja ancho 100	47 61 710	33,10	47 62 710	53,38	1	12	100
Para bandeja ancho 150	47 61 715	38,09	47 62 715	61,51	1	12	150
Para bandeja ancho 200	47 61 720	43,11	47 62 720	69,61	1	12	200
Para bandeja ancho 300	47 61 730	60,01	47 62 730	96,73	1	12	300
Para bandeja ancho 400	47 61 740	77,15	47 62 740	124,44	1	12	400
Para bandeja ancho 500	47 61 750	84,89	47 62 750	136,93	1	12	500
Para bandeja ancho 600	47 61 760	113,83	47 62 760	183,60	1	12	600

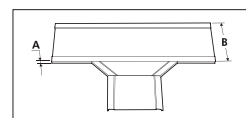

DERIVACIÓN Y TAPA SEMI "T"



47 61 XXX

Derivación semi "T"	SENDZIMIR		GALV. CALIENTE		U.Emb.	Dimensiones (mm)		
	Ref.	P.V.R. €/ud	Ref.	P.V.R. €/ud		A	B	C
Para bandeja 30x100	47 61 510	27,28	*		1	30	100	240
Para bandeja 30x150	47 61 515	28,29	*		1	30	150	290
Para bandeja 30x200	47 61 520	32,48	*		1	30	200	340
Para bandeja 30x300	47 61 530	40,71	*		1	30	300	440
Para bandeja 60x60	47 61 606	27,18	47 62 606	49,19	1	60	60	260
Para bandeja 60x100	47 61 610	27,99	47 62 610	51,64	1	60	100	240
Para bandeja 60x150	47 61 615	30,69	47 62 615	55,55	1	60	150	290
Para bandeja 60x200	47 61 620	33,39	47 62 620	60,44	1	60	200	340
Para bandeja 60x300	47 61 630	41,51	47 62 630	75,22	1	60	300	440
Para bandeja 80x100	47 61 810	35,98	47 62 810	65,14	1	80	100	240
Para bandeja 80x150	47 61 815	38,11	47 62 815	69,12	1	80	150	290
Para bandeja 80x200	47 61 820	41,41	47 62 820	75,01	1	80	200	340
Para bandeja 80x300	47 61 830	52,31	47 62 830	94,81	1	80	300	440

* Consultar disponibilidad.

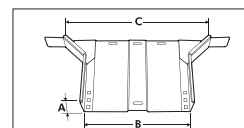

47 61 9XX

Tapa derivación semi "T"	SENDZIMIR		GALV. CALIENTE		U.Emb.	Dimensiones (mm)	
	Ref.	P.V.R. €/ud	Ref.	P.V.R. €/ud		A	B
Para bandeja ancho 60	47 61 906	23,18	47 62 906	40,09	1	12	60
Para bandeja ancho 100	47 61 910	25,11	47 62 910	43,48	1	12	100
Para bandeja ancho 150	47 61 915	26,61	47 62 915	46,07	1	12	150
Para bandeja ancho 200	47 61 920	28,30	47 62 920	49,05	1	12	200
Para bandeja ancho 300	47 61 930	36,36	47 62 930	62,96	1	12	300

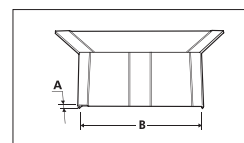

DERIVACIÓN Y TAPA EN CRUZ

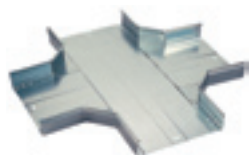

47 71 XXX

Derivación en cruz	SENDZIMIR		GALV. CALIENTE		U.Emb.	Dimensiones (mm)		
	Ref.	P.V.R. €/ud	Ref.	P.V.R. €/ud		A	B	C
Para bandeja 30x100	47 71 210	46,48	*		1	30	100	530
Para bandeja 30x150	47 71 215	53,16	*		1	30	150	580
Para bandeja 30x200	47 71 220	63,70	*		1	30	200	630
Para bandeja 30x300	47 71 230	78,11	*		1	30	300	730
Para bandeja 60x60	47 71 306	48,40	47 72 306	75,57	1	60	60	487,5
Para bandeja 60x100	47 71 310	49,36	47 72 310	77,05	1	60	100	530
Para bandeja 60x150	47 71 315	56,31	47 72 315	87,92	1	60	150	580
Para bandeja 60x200	47 71 320	67,54	47 72 320	105,44	1	60	200	630
Para bandeja 60x300	47 71 330	105,60	47 72 330	145,27	1	60	300	730
Para bandeja 60x400	47 71 340	123,81	47 72 340	193,30	1	60	400	830
Para bandeja 60x500	47 71 350	147,08	47 72 350	229,68	1	60	500	930
Para bandeja 60x600	47 71 360	163,68	47 72 360	255,56	1	60	600	1030
Para bandeja 80x100	47 71 410	54,78	47 72 410	85,49	1	80	100	530
Para bandeja 80x150	47 71 415	62,71	47 72 415	97,87	1	80	150	580
Para bandeja 80x200	47 71 420	75,48	47 72 420	117,83	1	80	200	630
Para bandeja 80x300	47 71 430	117,88	47 72 430	184,05	1	80	300	730
Para bandeja 80x400	47 71 440	144,11	47 72 440	225,06	1	80	400	830
Para bandeja 80x500	47 71 450	185,85	47 72 450	290,23	1	80	500	930
Para bandeja 80x600	47 71 460	198,86	47 72 460	310,51	1	80	600	1030

* Consultar disponibilidad.

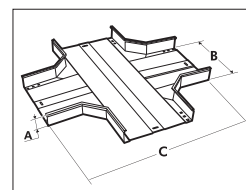

47 71 TXX

Tapa derivación en cruz	SENDZIMIR		GALV. CALIENTE		U.Emb.	Dimensiones (mm)	
	Ref.	P.V.R. €/ud	Ref.	P.V.R. €/ud		A	B
Para bandeja ancho 60	47 71 706	33,34	47 72 706	49,85	1	12	60
Para bandeja ancho 100	47 71 710	37,84	47 72 710	56,45	1	12	100
Para bandeja ancho 150	47 71 715	43,64	47 72 715	65,16	1	12	150
Para bandeja ancho 200	47 71 720	47,43	47 72 720	70,82	1	12	200
Para bandeja ancho 300	47 71 730	58,68	47 72 730	87,62	1	12	300
Para bandeja ancho 400	47 71 740	80,99	47 72 740	120,92	1	12	400
Para bandeja ancho 500	47 71 750	108,08	47 72 750	161,03	1	12	500
Para bandeja ancho 600	47 71 760	111,81	47 72 760	166,93	1	12	600

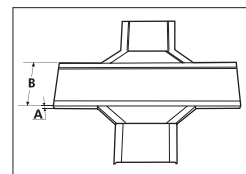

TAPA FINAL

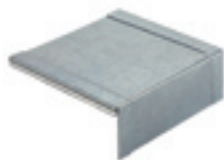

47 81 9XX

Tapa final	SENDZIMIR		GALV. CALIENTE		U.Emb.	Dimensiones (mm)		
	Ref.	P.V.R. €/ud	Ref.	P.V.R. €/ud		A	B	C
Para bandeja 30x100	47 81 930	4,73	*		1	30	100	80
Para bandeja 30x150	47 81 931	6,18	*		1	30	150	100
Para bandeja 30x200	47 81 932	7,28	*		1	30	200	125
Para bandeja 30x300	47 81 933	8,65	*		1	30	300	180
Para bandeja 60x60	47 81 950	3,95	47 82 950	6,82	1	60	60	100
Para bandeja 60x100	47 81 960	5,05	47 82 960	8,72	1	60	100	80
Para bandeja 60x150	47 81 961	6,50	47 82 961	11,18	1	60	150	100
Para bandeja 60x200	47 81 962	7,59	47 82 962	13,11	1	60	200	125
Para bandeja 60x300	47 81 963	8,86	47 82 963	15,26	1	60	300	180
Para bandeja 60x400	47 81 964	9,61	47 82 964	16,62	1	60	400	250
Para bandeja 60x500	47 81 965	10,90	47 82 965	18,79	1	60	500	275
Para bandeja 60x600	47 81 966	11,53	47 82 966	19,86	1	60	600	300
Para bandeja 80x100	47 81 980	5,99	47 82 980	10,36	1	80	100	80
Para bandeja 80x150	47 81 981	7,28	47 82 981	12,56	1	80	150	100
Para bandeja 80x200	47 81 982	8,55	47 82 982	14,71	1	80	200	125
Para bandeja 80x300	47 81 983	9,61	47 82 983	16,62	1	80	300	180
Para bandeja 80x400	47 81 984	10,26	47 82 984	17,71	1	80	400	250
Para bandeja 80x500	47 81 985	11,08	47 82 985	19,06	1	80	500	275
Para bandeja 80x600	47 81 986	11,85	47 82 986	20,41	1	80	600	300

* Consultar disponibilidad.

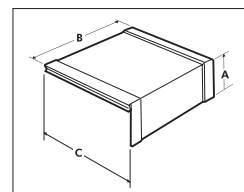

JUEGO DE REDUCCIONES



47 81 5XX

Juego de reducciones	SENDZIMIR		GALV. CALIENTE		U.Emb.	Dimensiones (mm)	
	Ref.	P.V.R. €/ud	Ref.	P.V.R. €/ud		A	B
Reducción 50 mm. ala 30	47 81 520	?	*		1	27	50
Reducción 100 mm. ala 30	47 81 521	?	*		1	27	100
Reducción 50 mm. ala 60	47 81 525	43,59	47 82 525	43,59	1	57	50
Reducción 100 mm. ala 60	47 81 526	49,00	47 82 526	49,00	1	57	100
Reducción 50 mm. ala 80	47 81 530	46,28	47 82 530	46,28	1	77	50
Reducción 100 mm. ala 80	47 81 531	51,70	47 82 531	51,70	1	77	100

■ Juego compuesto por dos piezas de reducción, izquierda y derecha.

* Consultar disponibilidad.

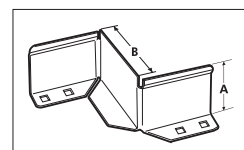

SOPORTE HORIZONTAL "FR"



45 51 1XX

Soporte	SENDZIMIR		GALVANIZADO CALIENTE		U.Emb.
	Ref.	P.V.R. €/ud	Ref.	P.V.R. €/ud	
Para bandeja ancho 100	45 51 110	7,58	45 52 110	10,33	10
Para bandeja ancho 150	45 51 115	8,72	45 52 115	11,28	10
Para bandeja ancho 200	45 51 120	10,34	45 52 120	12,63	10
Para bandeja ancho 300	45 51 130	12,80	45 52 130	18,89	10
Para bandeja ancho 400	45 51 140	18,91	45 52 140	25,28	5
Para bandeja ancho 500	45 51 150	21,28	45 52 150	30,69	5
Para bandeja ancho 600	45 51 160	24,26	45 52 160	33,95	5

■ También disponible en acabados **inoxidable**. Ver pág. 81.

Dimensiones (mm)			Carga (Kg)
A	B	C	
144	82	42	234
194	82	42	176
244	82	42	128
344	82	42	100
444	130	42	250
544	130	42	215
644	130	42	180

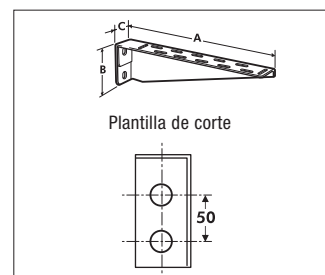

SOPORTE VERTICAL-SUSPENSIÓN "FR"



45 51 3XX

Soporte	SENDZIMIR		GALVANIZADO CALIENTE		U.Emb.
	Ref.	P.V.R. €/ud	Ref.	P.V.R. €/ud	
Para bandeja ancho 100	45 51 310	7,82	45 52 310	10,60	10
Para bandeja ancho 150	45 51 315	8,50	45 52 315	11,66	10
Para bandeja ancho 200	45 51 320	9,06	45 52 320	12,18	10
Para bandeja ancho 300	45 51 330	10,96	45 52 330	14,81	10
Para bandeja ancho 400	45 51 340	12,78	45 52 340	17,68	5
Para bandeja ancho 500	45 51 350	17,32	45 52 350	21,29	5
Para bandeja ancho 600	45 51 360	20,31	45 52 360	25,16	5

■ También disponible en acabados **inoxidable**. Ver pág. 84.

Dimensiones (mm)				Carga (Kg)
A	B	C	D	
50	150	185	38	121,7
50	200	235	38	79,2
50	250	285	38	177
50	350	385	38	112
50	450	485	38	70,7
50	550	585	38	50
50	650	685	38	29,9

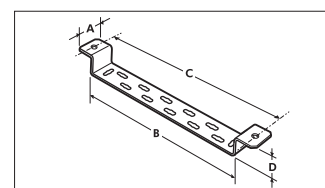

SOPORTE SUSPENSIÓN REFORZADO



45 51 6XX

Soporte	SENDZIMIR		
	Ref.	P.V.R. €/ud	U.Emb.
Para bandeja ancho 200	45 51 620	11,12	4
Para bandeja ancho 300	45 51 630	12,02	4
Para bandeja ancho 400	45 51 640	15,06	4
Para bandeja ancho 500	45 51 650	19,43	4
Para bandeja ancho 600	45 51 660	21,74	4

■ Soporte reversible para uso vertical cambiando la posición de las patas.

Dimensiones (mm)				Carga (kg)
A	B	C	D	
41,75	267,5	240	60	522,8
41,75	347,5	320	60	531
41,75	467,5	440	60	350
41,75	547,5	520	60	273,8
41,75	667,5	640	60	233,5

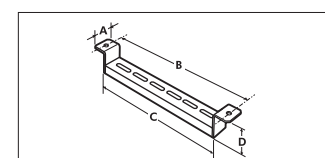

SOPORTE BASCULANTE



45 51 410

	SENDZIMIR		GALVANIZADO CALIENTE		U.Emb.
	Ref.	P.V.R. €/ud	Ref.	P.V.R. €/ud	
Soporte	45 51 410	11,30	45 52 410	16,80	4

- Su exclusivo diseño permite la suspensión de sistemas de bandeja en horizontal fijadas, tanto de techo como de superficies con inclinaciones distintas a 90°, por ejemplo túneles, bóvedas, etc.
- También disponible en acabados **inoxidable**. Ver pág. 81.

Dimensiones (mm)			
A	B	C	D
116	150	60	100

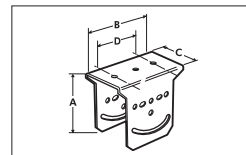

PERFIL EN "U"



45 51 420

	SENDZIMIR		GALVANIZADO CALIENTE		U.Emb.
	Ref.	P.V.R. €/m	Ref.	P.V.R. €/m	
Perfil	45 51 420	25,22	45 52 420	35,20	4

- Para una correcta fijación de los mismos y al objeto de soportar las cargas máximas admisibles, se deben de montar los perfiles en "U" de forma que los oblongos laterales formen un ángulo de 45° con respecto a la horizontal.
- También disponible en acabados **inoxidable**. Ver pág. 81.
- Longitud 1 m.

Dimensiones (mm)		
A	B	C
1000	55	30

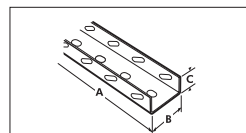

SOPORTE EN "C"



45 51 440

	SENDZIMIR		GALVANIZADO CALIENTE		U.Emb.
	Ref.	P.V.R. €/ud	Ref.	P.V.R. €/ud	
Soporte en "C"	45 51 440	4,15	45 52 440	6,89	10

- También disponible en acabados **inoxidable**. Ver pág. 82.

Dimensiones (mm)		
A	B	C
70	36	39

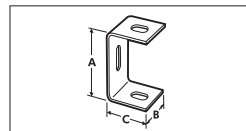

CONSOLA "FR"



45 51 9XX

	SENDZIMIR		GALVANIZADO CALIENTE		U.Emb.
	Ref.	P.V.R. €/ud	Ref.	P.V.R. €/ud	
Para bandeja ancho 100	45 51 910	8,57	45 52 910	11,87	10
Para bandeja ancho 150	45 51 915	9,29	45 52 915	12,95	10
Para bandeja ancho 200	45 51 920	10,46	45 52 920	14,51	10
Para bandeja ancho 300	45 51 930	13,31	45 52 930	17,71	10
Para bandeja ancho 400	45 51 940	16,03	45 52 940	21,54	4
Para bandeja ancho 500	45 51 950	18,70	45 52 950	27,90	4
Para bandeja ancho 600	45 51 960	23,27	45 52 960	31,21	4

- También disponible en acabados **inoxidable**. Ver pág. 82.

Dimensiones (mm)		
A	B	C
160	87	50
210	87	50
260	87	50
360	94,25	50
460	100	50
560	110	50
660	110	50

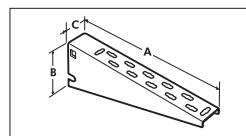

SOPORTE SUSPENSIÓN EN "L"



45 51 450

	SENDZIMIR		GALVANIZADO CALIENTE		U.Emb.
	Ref.	P.V.R. €/ud	Ref.	P.V.R. €/ud	
Soporte en "L"	45 51 450	4,15	45 52 450	6,89	10

■ También disponible en acabados **inoxidable**. Ver pág. 82.

Dimensiones (mm)		
A	B	C
104	36	39

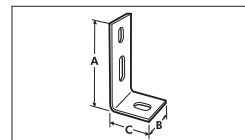

CONJUNTO VARILLA



45 51 4XX

Conjunto	SENDZIMIR		INOX		U.Emb.
	Ref.	P.V.R. €/ud	Ref.	P.V.R. €/ud	
M6-10 longitud 1 m.	45 51 467	4,74	-	-	10
M8-05 longitud 0,5 m.	45 51 470	3,37	45 55 470	12,85	10
M8-10 longitud 1m.	45 51 480	6,01	45 55 480	24,01	10
Conector varilla M6	45 51 481	2,88	-	-	50
Conector varilla M8	45 51 482	3,40	-	-	50

■ Se suministran completos.

Dimensiones (mm)		Carga (Kg)
A	B	
1000	M-6	100
500	M-8	100
1000	M-8	100
500	M-6	100
1000	M-8	100

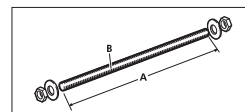

SOPORTE OMEGA HORIZONTAL "FR"



(1)

45 50 3XX

Soporte	SENDZIMIR		
	Ref.	P.V.R. €/ud	U.Emb.
Para bandeja ancho 100	45 50 310	6,54	10
Para bandeja ancho 150	45 50 315	6,92	10
Para bandeja ancho 200	45 50 320	8,27	10
Para bandeja ancho 300	45 50 330	9,45	10

(1) Refuerzo antiplastamiento. Se suministra junto con el soporte vertical-suspensión "FR".

Dimensiones (mm)				Carga (Kg)
A	B	C	D	
150	131	50	23	313,5
200	131	50	23	159,2
250	131	50	23	109,2
350	131	50	23	90

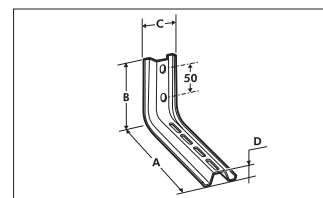

CONJUNTO SOPORTE HORIZONTAL "FR"



45 51 2XX

Conjunto

	SENDZIMIR		
	Ref.	P.V.R. €/ud	U.Emb.
Para bandeja ancho 100	45 51 210	11,52	2
Para bandeja ancho 150	45 51 215	13,14	2
Para bandeja ancho 200	45 51 220	15,17	2
Para bandeja ancho 300	45 51 230	17,59	2
Para bandeja ancho 400	45 51 240	20,34	2
Para bandeja ancho 500	45 51 250	26,44	2
Para bandeja ancho 600	45 51 260	31,66	2

■ También disponible en acabados **inoxidable** y **galvanizado en caliente**. Consultar disponibilidad.

Dimensiones (mm)			Carga (Kg)
A	B	C	
162	200	55	523
212	200	55	364,6
262	200	55	304
362	200	55	238
462	200	55	200
562	200	55	147
662	200	55	131,5

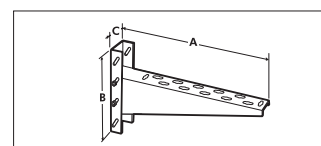

CONJUNTO SOPORTE ORIENTABLE "FR"



45 51 5XX

Conjunto

	SENDZIMIR		
	Ref.	P.V.R. €/ud	U.Emb.
Para bandeja ancho 100	45 51 510	17,06	2
Para bandeja ancho 150	45 51 515	18,96	2
Para bandeja ancho 200	45 51 520	20,56	2
Para bandeja ancho 300	45 51 530	28,06	2
Para bandeja ancho 400	45 51 540	32,51	2
Para bandeja ancho 500	45 51 550	38,11	2
Para bandeja ancho 600	45 51 560	42,12	2

■ También disponible en acabado **inoxidable**. Consultar disponibilidad.

Dimensiones (mm)		
A	B	C
162	140	55
212	140	55
262	140	55
362	140	55
462	140	55
562	140	55
662	140	55

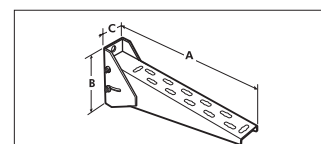

SOPORTE OMEGA SUSPENSIÓN "FR"



45 50 4XX

Soporte

	SENDZIMIR		
	Ref.	P.V.R. €/ud	U.Emb.
Para bandeja ancho 100	45 50 410	11,65	4
Para bandeja ancho 150	45 50 415	12,51	4
Para bandeja ancho 200	45 50 420	13,26	4
Para bandeja ancho 300	45 50 430	15,23	4

(1) Refuerzo antiplastamiento. Se suministra junto con el soporte vertical-suspensión "FR".

Dimensiones (mm)					Carga (kg)
A	B	C	D	E	
153	196	50	23	131	264
204	196	50	23	131	154
252	196	50	23	131	106,8
357	196	50	23	131	84,8

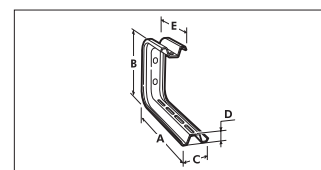

GRAPA TORNILLO VIGA



45 71 4XX

Grapa

Grapa tornillo viga 8

Grapa tornillo viga 10

ZINCADO			
Ref.	P.V.R. €/ud	U.Emb.	
45 71 408	17,80	10	
45 71 410	17,80	10	

Dimensiones (mm)								Carga (Kg)	Cap. máx. de viga (mm)
A	B	C	D	E	F	H			
36	38	18	12,8	Ø9	M8	19	120	10	
41,5	44,5	21	17	Ø11	M10	20	250	10	

- Para suspensión a viga de elementos utilizando varilla roscada.
- Material: acero zincado.

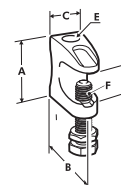

GRAPA HORIZONTAL DE SUSPENSIÓN



45 71 41X

Grapa horizontal

Grapa horizontal viga 6

Grapa horizontal viga 8

FOSFATADO-ZN			
Ref.	P.V.R. €/ud	U.Emb.	
45 71 416	3,98	20	
45 71 418	3,83	20	

Dimensiones (mm)						Carga (Kg)	Cap. máx. de viga (mm)
A	B	C	D	E	F		
5	21	46	6	19	40	70	4-10
50	21	46	8	19	40	70	4-10

- Material: acero con acabado superficial anticorrosivo.

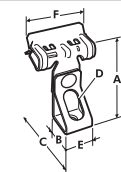

GRAPA VERTICAL DE SUSPENSIÓN



45 71 43X

Grapa vertical

Grapa vertical viga 6

Grapa vertical viga 8

FOSFATADO-ZN			
Ref.	P.V.R. €/ud	U.Emb.	
45 71 436	4,76	20	
45 71 438	4,40	20	

Dimensiones (mm)					Carga (Kg)	Cap. máx. de viga (mm)
A	B	C	D	E		
92	21	33	6	19	70	4-10
92	21	33	8	19	70	4-10

- Material: acero con acabado superficial anticorrosivo.

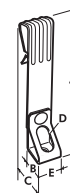

TORNILLOS FIJACIÓN



47 21 912

Tornillo	ZINCADO		BICROMATADO		INOXIDABLE		U.Emb.	Dimensiones (mm)		Apriete (N.m)
	Ref.	P.V.R. €/ud	Ref.	P.V.R. €/ud	Ref.	P.V.R. €/ud		A	B	
Tornillo M6x12	47 21 912	0,39	-	-	47 25 912	1,31	50	13,5	23,5	12
Tornillo M6x20	45 71 110	0,44	45 76 110	0,38	45 75 110	1,41	50	13,5	23,5	12
Tornillo M8x20	-	-	-	-	43 26 605	1,29	50	13,5	23,5	12

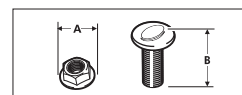

FIJACIÓN RÁPIDA "FR" METALNORMA SENDZIMIR



47 21 910

Fijación	Ref.	P.V.R. €/ud	U.Emb.
■ Especial bandeja perforada.	47 21 910	1,28	25

Esquema de aplicación

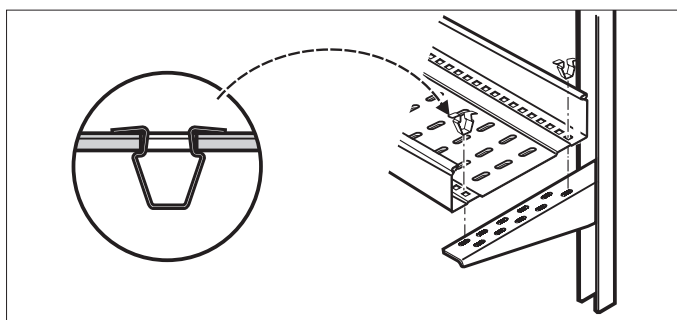

Dimensiones (mm)			
A	B	C	D
11,5	16	7,8	2,7

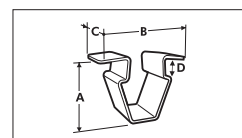

PERFILES TROQUELADOS



25 11 XXX

Perfil	SENDZIMIR		ZINCADO		M.Emb.
	Ref.	P.V.R. €/m	Ref.	P.V.R. €/m	
PR-1827	25 11 178	4,92	-	-	20
PR-1834	25 11 179	5,45	-	-	20
PR-2010	25 11 194	2,88	25 11 190	2,98	40
PR-2020	-	-	25 11 206	6,31	20
PR-2040	25 11 204	5,85	25 11 220	6,63	20
PR-2141 reforzado*	25 11 230	14,42	-	-	8
PR-4141 reforzado*	25 11 231	20,19	-	-	4
PRO reforzado**	25 11 240	21,19	-	-	4

- Longitud: 2 m.
- * Reforzados galvanizado sendzimir. Perfil PR.
- ** Reforzados galvanizado. Perfil PRO.



Perfil PR



Perfil PRO

Dimensiones (mm)				
A	B	C	D	E
18	27	7,5	-	1,2
18	34	8,5	-	1,5
10	20	4,5	-	1
20	20	6,5	-	1,5
20	40	7,5	-	1,5
21	41	9,5	7	2,5
41	41	,5	7	2,5
23	50	-	-	1,8

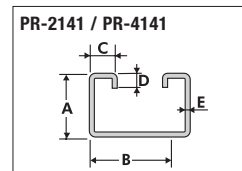
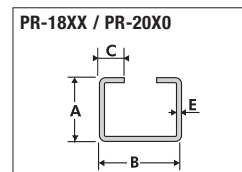

TUERCAS REFORZADAS CON MUELLE

25 21 7XX

Tuercas reforzadas con muelle	Ref.	P.V.R. €/ud	U.Emb.
Tuercas reforzada para M6	25 21 706	1,09	10
Tuercas reforzada para M8	25 21 708	1,14	10
Tuercas reforzada para M10	25 21 710	1,19	10
Tuercas c/muelle corto para M6	25 21 716	1,14	10
Tuercas c/muelle corto para M8	25 21 718	1,19	10
Tuercas c/muelle corto para M10	25 21 720	1,24	10
Tuercas c/muelle largo para M6	25 21 726	1,19	10
Tuercas c/muelle largo para M8	25 21 728	1,24	10
Tuercas c/muelle largo para M10	25 21 730	1,29	10

■ Para perfiles 2141 y 4141.

Dimensiones (mm)

A	B	C	D
-	-	- 6	M6
-	-	- 6	M8
-	-	- 8	M10
17	11	3 6	M6
17	11	3 6	M8
24	16	4 8	M10
37	31	6 6	M6
37	31	6 6	M8
37,5	29,5	7,5 8	M10

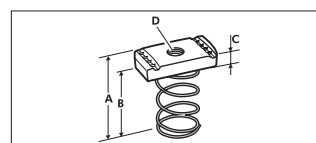
**TUERCAS CUADRADAS**

15 06 1XX

Tuercas cuadradas	Ref.	P.V.R. €/emb	U.Emb.
TM-4 para perfil 2020	15 06 110	18,63	100
TM-5 para perfil 2010 y 2020	15 06 120	20,59	100
TM-6 para perfil 2020 y 2010	15 06 130	21,62	100
TME-6 para perfil 2040	15 06 150	25,75	100
TME-8 para perfil 2040	15 06 155	67,92	100

Dimensiones (mm)

A	B	C	D
15	13	3	M4
18,8	16,8	3	M5
18,8	16,8	3	M6
36	20	5	M6
36	20	5	M8

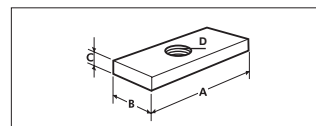

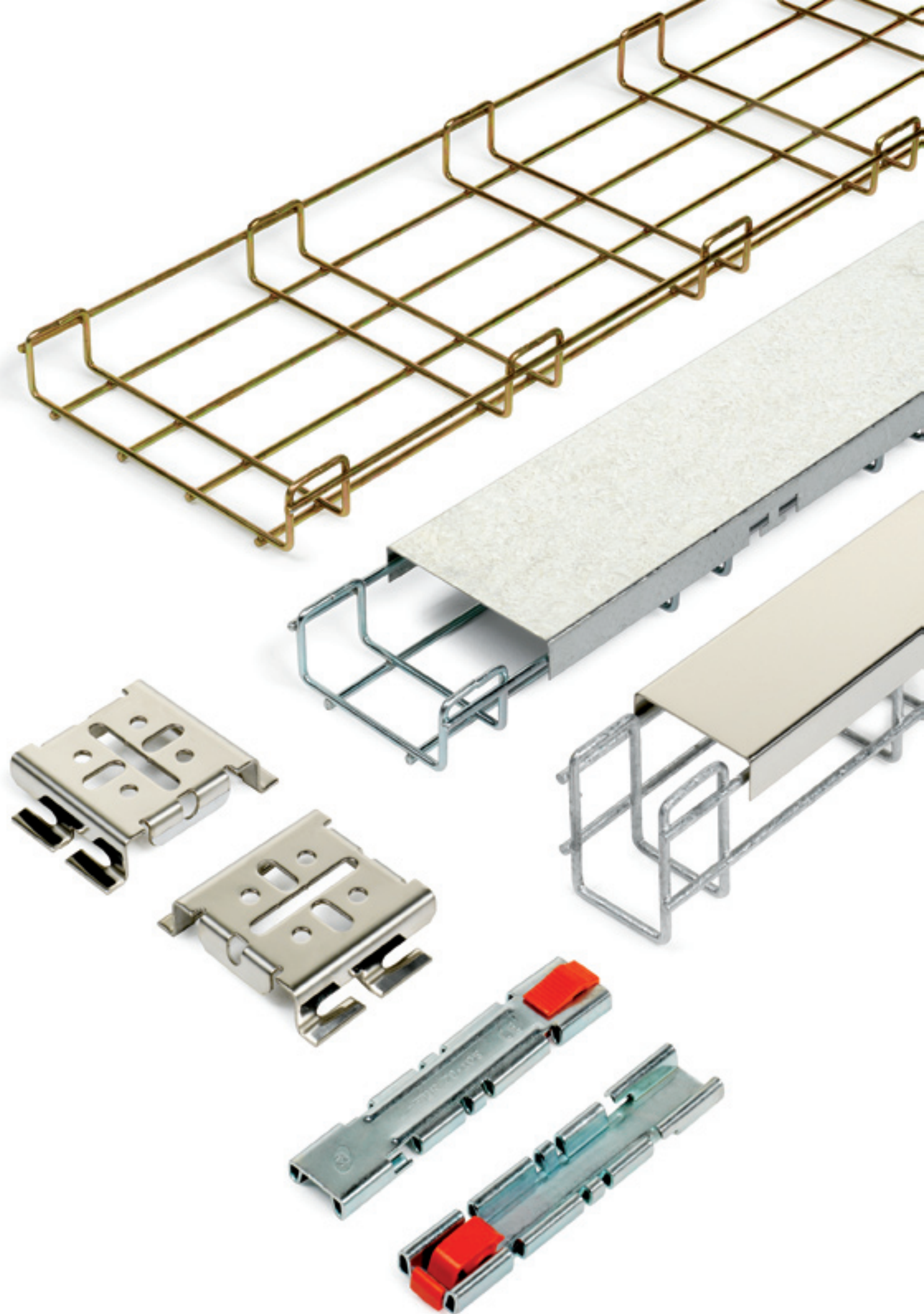

REJINORMA

CARACTERÍSTICAS GENERALES

- Rejinorma es la bandeja de rejilla de Aemsa.
- Rejinorma se distingue por su especial diseño de doble varilla transversal que garantiza una mayor capacidad de carga y la seguridad de quien manipula la instalación.
- Rejinorma se fabrica con alambres de acero al carbono y en acero inoxidable, confiriendo a sus soldaduras una óptima consistencia y a su estructura la facilidad de manejo.
- Rejinorma está disponible en cuatro acabados cada uno de ellos identificado por un color:
 - Galvanizado Sendzimir** - Color Azul
 - Galvanizado en caliente** - Color Rojo
 - Bicromatado** - Color Amarillo
 - Acero inoxidable** - Color Verde

PROPIEDADES

Longitud estándar: 3 metros para todos los acabados

Propiedades eléctricas: con continuidad eléctrica

Propiedades mecánicas: resistencia al impacto 20J

Rejinorma posee una amplia gama de accesorios rápidos que facilitan la instalación porque no requieren de útiles, manteniendo la calidad y la robustez de los accesorios tradicionales.

CAMPO DE APLICACIÓN

- Aplicaciones por acabado:
 - Galvanizado Sendzimir:** para instalaciones en lugares con agresividad moderada o media
 - Galvanizado en caliente:** para instalaciones en lugares con agresividad alta
 - Bicromatado:** para instalaciones en lugares con agresividad moderada o media
 - Inox:** para instalaciones en lugares con agresividad severa, especialmente para la industria química y la alimentaria

Hay que destacar que el diseño de la soportería hace posible que muchos accesorios puedan servir tanto por la bandeja de metal como por la bandeja de rejilla.

ACABADO ZINCADO								
Dimensiones (alto x ancho)	35x100	35x150	35x200	35x300	60x60	70x100	70x150	70x200
Bandejas								
Bandeja	45 11 110 24 m. 8,48 €/m	45 11 115 12 m. 10,50 €/m	45 11 120 12 m. 12,22 €/m	45 11 130 12 m. 16,43 €/m	45 11 206 24 m. 8,97 €/m	45 11 210 12 m. 11,21 €/m	45 11 215 12 m. 13,35 €/m	45 11 220 6 m. 16,43 €/m
Tapa								
3 Tapa para bandeja	45 41 110 4 m. 10,11 €/m	45 41 115 4 m. 11,35 €/m	45 41 120 4 m. 13,21 €/m	45 41 130 4 m. 21,75 €/m	45 41 106 8 m. 8,76 €/m	45 41 110 4 m. 10,11 €/m	45 41 115 4 m. 11,35 €/m	45 41 120 4 m. 13,21 €/m
Accesorios								
3 Tabique separador		45 71 510 20 m. 7,00 €/m			-			
Brida de unión		(1) 45 61 110 50 uds. 1,69 €/ud			45 61 110 50 uds. 1,69 €/ud			
Brida de unión rápida		45 61 170 10 uds. 4,81 €/ud			-			
Unión lateral		45 61 200 25 uds. 1,93 €/ud			-			
2 Unión extensible		45 61 150 10 uds. 3,79 €/ud			45 61 150 10 uds. 3,79 €/ud			
2 Soporte sujeción y suspensión		45 71 120 10 uds. 7,25 €/ud	45 71 130 5 uds. 15,54 €/ud		45 71 120 10 uds. 7,25 €/ud			
Suspensión central		45 51 430 30 uds. 1,56 €/ud			45 51 430 30 uds. 1,56 €/ud			
1 Placa derivación tubos		45 71 315 10 uds. 4,67 €/ud			45 71 315 10 uds. 4,67 €/ud			
Borne puesta a tierra		45 71 310 10 uds. 18,02 €/ud			45 71 310 10 uds. 18,02 €/ud			
Elevador aislante		45 71 700 20 uds. 2,98 €/ud			45 71 700 20 uds. 2,98 €/ud			
Tarjeta Rejinorma		45 51 485 25 uds. 1,39 €/ud			45 51 485 25 uds. 1,39 €/ud			
Herramienta de corte		45 80 110 1 uds. 386,28 €/ud			45 80 110 1 uds. 386,28 €/ud			
4 Protector retoques		45 80 130 1 uds. 127,82 €/ud			45 80 130 1 uds. 127,82 €/ud			

Código **XX XX XXX**
Embalaje 0 uds.
PVR 0,00 €/ud

1 Acabado sendzimir.
2 Acabado sendzimir, disponible también en inoxidable.



3 Acabado sendzimir, disponible también en galvanizado en caliente e inoxidable.

4 Acabado zincado, disponible también en bricomatado.

70x300	70x400	70x500	70x600	105x200	105x300	105x400	105x500	105x600
45 11 230 6 m. 22,22 €/m	45 11 240 6 m. 31,34 €/m	45 11 250 6 m. 36,51 €/m	45 11 260 6 m. 42,93 €/m	45 11 320 6 m. 25,39 €/m	45 11 330 6 m. 30,83 €/m	45 11 340 6 m. 36,71 €/m	45 11 350 6 m. 42,27 €/m	45 11 360 6 m. 47,62 €/m
45 41 130 4 m. 17,40 €/m	45 41 140 4 m. 27,51 €/m	45 41 150 4 m. 36,44 €/m	45 41 160 4 m. 40,74 €/m	45 41 120 4 m. 13,21 €/m	45 41 130 4 m. 21,75 €/m	45 41 140 4 m. 27,51 €/m	45 41 150 4 m. 36,44 €/m	45 41 160 4 m. 40,74 €/m
45 71 520 20 m. 8,23 €/m				45 71 530 20 m. 13,49 €/m				
(1) 45 61 110 50 uds. 1,69 €/ud				(1) 45 61 110 50 uds. 1,69 €/ud				
45 61 180 10 uds. 5,20 €/ud				45 61 180 10 uds. 5,20 €/ud				
45 61 205 25 uds. 2,16 €/ud				45 61 205 25 uds. 2,16 €/ud				
45 61 150 10 uds. 3,79 €/ud				45 61 150 10 uds. 3,79 €/ud				
45 71 120 10 uds. 7,25 €/ud	45 71 130 5 uds. 15,54 €/ud				45 71 120 10 uds. 7,25 €/ud	45 71 130 5 uds. 15,54 €/ud		
45 51 430 30 uds. 1,56 €/ud				45 51 430 30 uds. 1,56 €/ud				
45 71 315 10 uds. 4,67 €/ud				45 71 315 10 uds. 4,67 €/ud				
45 71 310 10 uds. 18,02 €/ud				45 71 310 10 uds. 18,02 €/ud				
45 71 700 20 uds. 2,98 €/ud				45 71 700 20 uds. 2,98 €/ud				
45 51 485 25 uds. 1,39 €/ud				45 51 485 25 uds. 1,39 €/ud				
45 80 110 1 uds. 386,28 €/ud				45 80 110 1 uds. 386,28 €/ud				
45 80 130 1 uds. 127,82 €/ud				45 80 130 1 uds. 127,82 €/ud				

■ Longitud de bandejas: 3 m.
Longitud de tapas y tabiques: 2 m.

(1) Recomendado como unión central para anchos de:
150 y 200: 1 unidad
300 y 400: 2 unidades
500 y 600: 3 unidades

ACABADO ZINCADO								
Dimensiones (alto x ancho)	35x100	35x150	35x200	35x300	60x60	70x100	70x150	70x200
Bandejas								
Bandeja 	45 11 110	45 11 115	45 11 120	45 11 130	45 11 206	45 11 210	45 11 215	45 11 220
Soportería								
1 Soporte horizontal rápido 	45 50 110 10 uds. 8,68 €/ud	45 50 111 10 uds. 9,46 €/ud	45 50 112 10 uds. 11,00 €/ud	45 50 113 10 uds. 13,60 €/ud	-	45 50 110 10 uds. 8,68 €/ud	45 50 111 10 uds. 9,46 €/ud	45 50 112 10 uds. 11,00 €/ud
3 Soporte horizontal "FR" 	45 51 110 10 uds. 8,24 €/ud	45 51 115 10 uds. 9,48 €/ud	45 51 120 10 uds. 10,78 €/ud	45 51 130 10 uds. 13,02 €/ud	-	45 51 110 10 uds. 8,24 €/ud	45 51 115 10 uds. 9,48 €/ud	45 51 120 10 uds. 10,78 €/ud
3 Consola "FR" 	45 51 910 10 uds. 8,93 €/ud	45 51 915 10 uds. 9,68 €/ud	45 51 920 10 uds. 10,90 €/ud	45 51 930 10 uds. 13,86 €/ud	-	45 51 910 10 uds. 8,93 €/ud	45 51 915 10 uds. 9,68 €/ud	45 51 920 10 uds. 10,90 €/ud
1 Soporte Omega horizontal "FR" 	45 50 310 10 uds. 7,11 €/ud	45 50 315 10 uds. 7,53 €/ud	45 50 320 10 uds. 8,99 €/ud	45 50 330 10 uds. 10,28 €/ud	-	45 50 310 10 uds. 7,11 €/ud	45 50 315 10 uds. 7,53 €/ud	45 50 320 10 uds. 8,99 €/ud
4 Conjunto soporte horizontal "FR" 	45 51 210 2 uds. 12,00 €/ud	45 51 215 2 uds. 13,69 €/ud	45 51 220 2 uds. 15,80 €/ud	45 51 230 2 uds. 18,33 €/ud	-	45 51 210 2 uds. 12,00 €/ud	45 51 215 2 uds. 13,69 €/ud	45 51 220 2 uds. 15,80 €/ud
2 Conjunto soporte orientable "FR" 	45 51 510 2 uds. 17,78 €/ud	45 51 515 2 uds. 19,75 €/ud	45 51 520 2 uds. 21,41 €/ud	45 51 530 2 uds. 29,23 €/ud	-	45 51 510 2 uds. 17,78 €/ud	45 51 515 2 uds. 19,75 €/ud	45 51 520 2 uds. 21,41 €/ud
1 Soporte omega suspensión "FR" 	45 50 410 4 uds. 12,66 €/ud	45 50 415 4 uds. 13,60 €/ud	45 50 420 4 uds. 14,41 €/ud	45 50 430 4 uds. 16,55 €/ud	-	45 50 410 4 uds. 12,66 €/ud	45 50 415 4 uds. 13,60 €/ud	45 50 420 4 uds. 14,41 €/ud
3 Soporte vertical suspensión "FR" 	45 51 310 10 uds. 7,82 €/ud	45 51 315 10 uds. 8,50 €/ud	45 51 320 10 uds. 9,06 €/ud	45 51 330 10 uds. 10,96 €/ud	-	45 51 310 10 uds. 7,82 €/ud	45 51 315 10 uds. 8,50 €/ud	45 51 320 10 uds. 9,06 €/ud
1 Soporte suspensión reforzado 	-	-	45 51 620 4 uds. 11,59 €/ud	45 51 630 4 uds. 12,53 €/ud	-	-	-	45 51 620 4 uds. 11,59 €/ud

Soportería común a todas las dimensiones de bandejas

Fijación rápida "FR" Rejinorma 	45 61 160 25 uds. 1,00 €/ud	3 Perfil en "U" 	45 51 420 4 m. 26,28 €/m	Conjunto varilla 	Ver pág. 83	
Brida fijación Rejinorma 	45 61 120 50 uds. 1,24 €/ud	3 Soporte en "C" 	45 51 440 10 uds. 4,33 €/ud	4 Grapa tornillo viga 	45 71 408 10 uds. 17,80 €/ud	45 71 410 10 uds. 17,80 €/ud
3 Soporte basculante 	45 51 410 4 uds. 11,78 €/ud	3 Soporte suspensión en "L" 	45 51 450 10 uds. 4,33 €/ud	5 Grapa horizontal suspensión 	45 71 416 20 uds. 3,98 €/ud	45 71 418 20 uds. 3,83 €/ud

Código **XX XX XXX**
Embalaje 0 uds.
PVR 0,00 €/ud

- 1 Acabado sendzimir.
- 2 Acabado sendzimir, disponible también en inoxidable.
- 3 Acabado sendzimir, disponible también en galvanizado en caliente e inoxidable.
- 4 Acabado sendzimir, consultar disponibilidad inox. y galvanizado caliente.

70x300	70x400	70x500	70x600	105x200	105x300	105x400	105x500	105x600
45 11 230	45 11 240	45 11 250	45 11 260	45 11 320	45 11 330	45 11 340	45 11 350	45 11 360
45 50 113 10 uds. 13,60 €/ud	45 50 114 10 uds. 19,69 €/ud	45 50 115 10 uds. 22,61 €/ud	45 50 116 10 uds. 27,50 €/ud	45 50 112 10 uds. 11,00 €/ud	45 50 113 10 uds. 13,60 €/ud	45 50 114 10 uds. 19,69 €/ud	45 50 115 10 uds. 22,61 €/ud	45 50 116 10 uds. 27,50 €/ud
45 51 130 10 uds. 13,02 €/ud	45 51 140 5 uds. 18,75 €/ud	45 51 150 5 uds. 21,45 €/ud	45 51 160 5 uds. 24,26 €/ud	45 51 120 10 uds. 10,78 €/ud	45 51 130 10 uds. 13,02 €/ud	45 51 140 5 uds. 18,75 €/ud	45 51 150 5 uds. 21,45 €/ud	45 51 160 5 uds. 24,26 €/ud
45 51 930 10 uds. 13,86 €/ud	45 51 940 4 uds. 16,70 €/ud	45 51 950 4 uds. 19,48 €/ud	45 51 960 4 uds. 24,24 €/ud	45 51 920 10 uds. 10,90 €/ud	45 51 930 10 uds. 13,86 €/ud	45 51 940 4 uds. 16,70 €/ud	45 51 950 4 uds. 19,48 €/ud	45 51 960 4 uds. 24,24 €/ud
45 50 330 10 uds. 10,28 €/ud	-	-	-	45 50 320 10 uds. 8,99 €/ud	45 50 330 10 uds. 10,28 €/ud	-	-	-
45 51 230 2 uds. 18,33 €/ud	45 51 240 2 uds. 21,19 €/ud	45 51 250 2 uds. 27,54 €/ud	45 51 260 2 uds. 32,98 €/ud	45 51 220 2 uds. 15,80 €/ud	45 51 230 2 uds. 14,66 €/ud	45 51 240 2 uds. 21,19 €/ud	45 51 250 2 uds. 27,54 €/ud	45 51 260 2 uds. 32,98 €/ud
45 51 530 2 uds. 29,23 €/ud	45 51 540 2 uds. 33,86 €/ud	45 51 550 2 uds. 39,70 €/ud	45 51 560 2 uds. 43,88 €/ud	45 51 520 2 uds. 21,41 €/ud	45 51 530 2 uds. 29,23 €/ud	45 51 540 2 uds. 33,86 €/ud	45 51 550 2 uds. 39,70 €/ud	45 51 560 2 uds. 43,88 €/ud
45 50 430 4 uds. 16,55 €/ud	-	-	-	45 50 420 4 uds. 14,41 €/ud	45 50 430 4 uds. 16,55 €/ud	-	-	-
45 51 330 10 uds. 10,96 €/ud	45 51 340 5 uds. 12,78 €/ud	45 51 350 5 uds. 17,32 €/ud	45 51 360 5 uds. 20,31 €/ud	45 51 320 10 uds. 9,06 €/ud	45 51 330 10 uds. 10,96 €/ud	45 51 340 5 uds. 12,78 €/ud	45 51 350 5 uds. 17,32 €/ud	45 51 360 5 uds. 20,31 €/ud
45 51 630 4 uds. 12,53 €/ud	45 51 640 4 uds. 15,69 €/ud	45 51 650 4 uds. 20,24 €/ud	45 51 660 4 uds. 22,65 €/ud	45 51 620 4 uds. 11,59 €/ud	45 51 630 4 uds. 12,53 €/ud	45 51 640 4 uds. 15,69 €/ud	45 51 650 4 uds. 20,24 €/ud	45 51 660 4 uds. 22,65 €/ud

 <p>Grapa horizontal suspensión</p>	<p>45 71 436 20 uds. 4,76 €/ud</p>	<p>45 71 438 20 uds. 4,40 €/ud</p>
 <p>Perfiles troquelados</p>	Ver pág. 86	

 <p>Tornillos de fijación M6x12</p>	<p>47 21 912 150/50 uds. 0,39 €/ud</p>
 <p>Tornillos de fijación M6x20</p>	<p>45 71 110 150/50 uds. 0,44 €/ud</p>









 <p>Tuercas reforzadas y con muelle</p>	Ver pág. 87
 <p>Tuercas cuadradas</p>	Ver pág. 87

ACABADO BICROMATADO								
Dimensiones (alto x ancho)	35x100	35x150	35x200	35x300	60x60	70x100	70x150	70x200
Bandejas								
Bandeja	45 16 110 24 m. 8,48 €/m	45 16 115 12 m. 10,50 €/m	45 16 120 12 m. 12,22 €/m	45 16 130 12 m. 16,43 €/m	45 16 206 24 m. 8,97 €/m	45 16 210 12 m. 11,21 €/m	45 16 215 12 m. 13,35 €/m	45 16 220 6 m. 16,43 €/m
Tapa								
3 Tapa para bandeja	45 41 110 4 m. 10,11 €/m	45 41 115 4 m. 11,35 €/m	45 41 120 4 m. 13,21 €/m	45 41 130 4 m. 21,75 €/m	45 41 106 8 m. 8,76 €/m	45 41 110 4 m. 10,11 €/m	45 41 115 4 m. 11,35 €/m	45 41 120 4 m. 13,21 €/m
Accesorios								
3 Tabique separador		45 71 510 20 m. 7,00 €/m			-			
Brida de unión		(1) 45 66 110 50 uds. 1,69 €/ud			45 66 110 50 uds. 1,69 €/ud			
Brida de unión rápida		45 66 170 10 uds. 4,81 €/ud			-			
Unión lateral		45 66 200 25 uds. 1,93 €/ud			-			
2 Unión extensible		45 61 150 10 uds. 3,95 €/ud			45 61 150 10 uds. 3,95 €/ud			
2 Soporte sujeción y suspensión		45 71 120 10 uds. 7,55 €/ud	45 71 130 5 uds. 16,19 €/ud		45 71 120 10 uds. 7,55 €/ud			
Suspensión central		45 56 430 30 uds. 1,56 €/ud			45 56 430 30 uds. 1,56 €/ud			
1 Placa derivación tubos		45 71 315 10 uds. 4,67 €/ud			45 71 315 10 uds. 4,67 €/ud			
4 Borne puesta a tierra		45 71 310 10 uds. 18,02 €/ud			45 71 310 10 uds. 18,02 €/ud			
Elevador aislante		45 71 700 20 uds. 2,98 €/ud			45 71 700 20 uds. 2,98 €/ud			
Tarjeta Rejinorma		45 51 485 25 uds. 1,39 €/ud			45 51 485 25 uds. 1,39 €/ud			
Herramienta de corte		45 80 110 1 uds. 386,28 €/ud			45 80 110 1 uds. 386,28 €/ud			
5 Protector retoques		45 80 131 1 uds. 156,20 €/ud			45 80 131 1 uds. 156,20 €/ud			

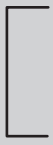
Código **XX XX XXX**
Embalaje 0 uds.
PVR 0,00 €/ud

- 1** Acabado sendzimir.
2 Acabado sendzimir, disponible también en inoxidable.

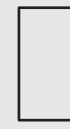
- 3** Acabado sendzimir, disponible también en galvanizado en caliente e inoxidable.
4 Acabado zincado.
5 Acabado bicromatado, disponible también en zincado.

70x300	70x400	70x500	70x600	105x200	105x300	105x400	105x500	105x600
								
45 16 230 6 m. 22,22 €/m	45 16 240 6 m. 31,34 €/m	45 16 250 6 m. 36,51 €/m	45 16 260 6 m. 42,53 €/m	45 16 320 6 m. 25,39 €/m	45 16 330 6 m. 30,83 €/m	45 16 340 6 m. 36,71 €/m	45 16 350 6 m. 42,27 €/m	45 16 360 6 m. 47,62 €/m
45 41 130 4 m. 21,75 €/m	45 41 140 4 m. 27,51 €/m	45 41 150 4 m. 36,44 €/m	45 41 160 4 m. 40,74 €/m	45 41 120 4 m. 13,21 €/m	45 41 130 4 m. 21,75 €/m	45 41 140 4 m. 27,51 €/m	45 41 150 4 m. 36,44 €/m	45 41 160 4 m. 40,74 €/m
45 71 520 20 m. 8,23 €/m				45 71 530 20 m. 13,49 €/m				
(1) 45 66 110 50 uds. 1,69 €/ud				(1) 45 66 110 50 uds. 1,69 €/ud				
45 66 180 10 uds. 5,20 €/ud				45 66 180 10 uds. 5,20 €/ud				
45 66 205 25 uds. 2,16 €/ud				45 66 205 25 uds. 2,16 €/ud				
45 61 150 10 uds. 3,95 €/ud				45 61 150 10 uds. 3,95 €/ud				
45 71 120 10 uds. 7,55 €/ud	45 71 130 5 uds. 16,19 €/ud				45 71 120 10 uds. 7,55 €/ud	45 71 130 5 uds. 16,19 €/ud		
45 56 430 30 uds. 1,56 €/ud				45 56 430 30 uds. 1,56 €/ud				
45 71 315 10 uds. 4,67 €/ud				45 71 315 10 uds. 4,67 €/ud				
45 71 310 10 uds. 18,02 €/ud				45 71 310 10 uds. 18,02 €/ud				
45 71 700 20 uds. 2,98 €/ud				45 71 700 20 uds. 2,98 €/ud				
45 51 485 25 uds. 1,39 €/ud				45 51 485 25 uds. 1,39 €/ud				
45 80 110 1 uds. 386,28 €/ud				45 80 110 1 uds. 386,28 €/ud				
45 80 131 1 uds. 156,20 €/ud				45 80 131 1 uds. 156,20 €/ud				

■ Longitud de bandejas: 3 m.
Longitud de tapas y tabiques: 2 m.

(1) Recomendado como unión central para anchos de:
150 y 200: 1 unidad
300 y 400: 2 unidades
500 y 600: 3 unidades

ACABADO BICROMATADO								
Dimensiones (alto x ancho)	35x100	35x150	35x200	35x300	60x60	70x100	70x150	70x200
Bandejas								
Bandeja 	45 16 110	45 16 115	45 16 120	45 16 130	45 16 206	45 16 210	45 16 215	45 16 220
Soportería								
1 Soporte horizontal rápido 	45 50 110 10 uds. 8,68 €/ud	45 50 111 10 uds. 9,46 €/ud	45 50 112 10 uds. 11,00 €/ud	45 50 113 10 uds. 13,60 €/ud	-	45 50 110 10 uds. 8,68 €/ud	45 50 111 10 uds. 9,46 €/ud	45 50 112 10 uds. 11,00 €/ud
3 Soporte horizontal "FR" 	45 51 110 10 uds. 7,58 €/ud	45 51 115 10 uds. 8,72 €/ud	45 51 120 10 uds. 10,34 €/ud	45 51 130 10 uds. 12,80 €/ud	-	45 51 110 10 uds. 7,58 €/ud	45 51 115 10 uds. 8,72 €/ud	45 51 120 10 uds. 10,34 €/ud
3 Consola "FR" 	45 51 910 10 uds. 8,57 €/ud	45 51 915 10 uds. 9,29 €/ud	45 51 920 10 uds. 10,46 €/ud	45 51 930 10 uds. 13,31 €/ud	-	45 51 910 10 uds. 8,57 €/ud	45 51 915 10 uds. 9,29 €/ud	45 51 920 10 uds. 10,46 €/ud
1 Soporte Omega horizontal "FR" 	45 50 310 10 uds. 6,54 €/ud	45 50 315 10 uds. 6,92 €/ud	45 50 320 10 uds. 8,27 €/ud	45 50 330 10 uds. 9,45 €/ud	-	45 50 310 10 uds. 6,54 €/ud	45 50 315 10 uds. 6,92 €/ud	45 50 320 10 uds. 8,27 €/ud
4 Conjunto soporte horizontal "FR" 	45 51 210 2 uds. 12,00 €/ud	45 51 215 2 uds. 13,69 €/ud	45 51 220 2 uds. 15,80 €/ud	45 51 230 2 uds. 18,33 €/ud	-	45 51 210 2 uds. 12,00 €/ud	45 51 215 2 uds. 13,69 €/ud	45 51 220 2 uds. 15,80 €/ud
2 Conjunto soporte orientable "FR" 	45 51 510 2 uds. 17,78 €/ud	45 51 515 2 uds. 19,75 €/ud	45 51 520 2 uds. 21,41 €/ud	45 51 530 2 uds. 29,23 €/ud	-	45 51 510 2 uds. 17,78 €/ud	45 51 515 2 uds. 19,75 €/ud	45 51 520 2 uds. 21,41 €/ud
1 Soporte omega suspensión "FR" 	45 50 410 4 uds. 11,65 €/ud	45 50 415 4 uds. 12,51 €/ud	45 50 420 4 uds. 13,26 €/ud	45 50 430 4 uds. 15,23 €/ud	-	45 50 410 4 uds. 11,65 €/ud	45 50 415 4 uds. 12,51 €/ud	45 50 420 4 uds. 13,26 €/ud
3 Soporte vertical suspensión "FR" 	45 51 310 10 uds. 7,82 €/ud	45 51 315 10 uds. 8,50 €/ud	45 51 320 10 uds. 9,06 €/ud	45 51 330 10 uds. 10,96 €/ud	-	45 51 310 10 uds. 7,82 €/ud	45 51 315 10 uds. 8,50 €/ud	45 51 320 10 uds. 9,06 €/ud
1 Soporte suspensión reforzado 	-	-	45 51 620 4 uds. 11,59 €/ud	45 51 630 4 uds. 12,53 €/ud	-	-	-	45 51 620 4 uds. 11,59 €/ud

Soportería común a todas las dimensiones de bandejas

Fijación rápida "FR" Rejinorma 	45 61 160 25 uds. 1,00 €/ud	3 Perfil en "U" 	45 51 420 4 uds. 25,22 €/m	Conjunto varilla 	Ver pág. 83	
Brida fijación Rejinorma 	45 66 120 50 uds. 1,24 €/ud	3 Soporte en "C" 	45 51 440 10 uds. 4,15 €/ud	4 Grapa tornillo viga 	45 71 408 10 uds. 17,80 €/ud	45 71 410 10 uds. 17,80 €/ud
3 Soporte basculante 	45 51 410 4 uds. 11,30 €/ud	3 Soporte suspensión en "L" 	45 51 450 10 uds. 4,15 €/ud	5 Grapa horizontal suspensión 	45 71 416 20 uds. 3,98 €/ud	45 71 418 20 uds. 3,83 €/ud



Código **XX XX XXX**
Embalaje 0 uds.
PVR 0,00 €/ud

- 1** Acabado sendzimir.
2 Acabado sendzimir, disponible también en inoxidable.
3 Acabado sendzimir, disponible también en galvanizado en caliente e inoxidable.















- 4** Acabado sendzimir. Consultar disponibilidad acabado inox y galvanizado en caliente.

70x300	70x400	70x500	70x600	105x200	105x300	105x400	105x500	105x600
45 16 230	45 16 240	45 16 250	45 16 260	45 16 320	45 16 330	45 16 340	45 16 350	45 16 360
45 50 113 10 uds. 13,60 €/ud	45 50 114 10 uds. 19,69 €/ud	45 50 115 10 uds. 22,61 €/ud	45 50 116 10 uds. 27,50 €/ud	45 50 112 10 uds. 11,00 €/ud	45 50 113 10 uds. 13,60 €/ud	45 50 114 10 uds. 19,69 €/ud	45 50 115 10 uds. 22,61 €/ud	45 50 116 10 uds. 27,50 €/ud
45 51 130 10 uds. 12,80 €/ud	45 51 140 5 uds. 18,91 €/ud	45 51 150 5 uds. 21,28 €/ud	45 51 160 5 uds. 24,26 €/ud	45 51 120 10 uds. 10,34 €/ud	45 51 130 10 uds. 12,80 €/ud	45 51 140 5 uds. 18,91 €/ud	45 51 150 5 uds. 21,28 €/ud	45 51 160 5 uds. 24,26 €/ud
45 51 930 10 uds. 13,31 €/ud	45 51 940 4 uds. 16,03 €/ud	45 51 950 4 uds. 18,70 €/ud	45 51 960 4 uds. 23,27 €/ud	45 51 920 10 uds. 10,46 €/ud	45 51 930 10 uds. 13,31 €/ud	45 51 940 4 uds. 16,03 €/ud	45 51 950 4 uds. 19,70 €/ud	45 51 960 4 uds. 23,27 €/ud
45 50 330 10 uds. 9,45 €/ud	-	-	-	45 50 320 10 uds. 8,27 €/ud	45 50 330 10 uds. 9,45 €/ud	-	-	-
45 51 230 2 uds. 18,33 €/ud	45 51 240 2 uds. 21,19 €/ud	45 51 250 2 uds. 27,54 €/ud	45 51 260 2 uds. 32,98 €/ud	45 51 220 2 uds. 15,80 €/ud	45 51 230 2 uds. 18,33 €/ud	45 51 240 2 uds. 21,19 €/ud	45 51 250 2 uds. 27,54 €/ud	45 51 260 2 uds. 32,98 €/ud
45 51 530 2 uds. 29,23 €/ud	45 51 540 2 uds. 33,86 €/ud	45 51 550 2 uds. 39,70 €/ud	45 51 560 2 uds. 43,88 €/ud	45 51 520 2 uds. 21,41 €/ud	45 51 530 2 uds. 29,23 €/ud	45 51 540 2 uds. 33,86 €/ud	45 51 550 2 uds. 39,70 €/ud	45 51 560 2 uds. 43,88 €/ud
45 50 430 4 uds. 15,23 €/ud	-	-	-	45 50 420 4 uds. 13,26 €/ud	45 50 430 4 uds. 15,23 €/ud	-	-	-
45 51 330 10 uds. 10,96 €/ud	45 51 340 5 uds. 12,78 €/ud	45 51 350 5 uds. 17,32 €/ud	45 51 360 5 uds. 20,31 €/ud	45 51 320 10 uds. 9,06 €/ud	45 51 330 10 uds. 10,96 €/ud	45 51 340 5 uds. 12,78 €/ud	45 51 350 5 uds. 17,32 €/ud	45 51 360 5 uds. 20,31 €/ud
45 51 630 4 uds. 12,53 €/ud	45 51 640 4 uds. 15,69 €/ud	45 51 650 4 uds. 20,24 €/ud	45 51 660 4 uds. 22,65 €/ud	45 51 620 4 uds. 11,59 €/ud	45 51 630 4 uds. 12,53 €/ud	45 51 640 4 uds. 15,69 €/ud	45 51 650 4 uds. 20,24 €/ud	45 51 660 4 uds. 22,65 €/ud

 <p>Grapa horizontal suspensión</p>	45 71 436 20 uds. 4,76 €/ud	45 71 438 20 uds. 4,40 €/ud
 <p>Perfiles troquelados</p>	Ver pág. 86	

 <p>Tornillos de fijación M6x12</p>	47 21 912 150/50 uds. 0,39 €/ud
 <p>Tornillos de fijación M6x20</p>	45 76 110 150/50 uds. 0,38 €/ud

 <p>Tuercas reforzadas y con muelle</p>	Ver pág. 87
 <p>Tuercas cuadradas</p>	Ver pág. 87

ACABADO GALVANIZADO EN CALIENTE								
Dimensiones (alto x ancho)	35x100	35x150	35x200	35x300	60x60	70x100	70x150	70x200
Bandejas								
Bandeja 	45 12 110 24 m. 10,32 €/m	45 12 115 12 m. 15,01 €/m	45 12 120 12 m. 17,08 €/m	45 12 130 12 m. 23,24 €/m	45 12 206 24 m. 12,56 €/m	45 12 210 12 m. 16,35 €/m	45 12 215 12 m. 18,03 €/m	45 12 220 6 m. 22,36 €/m
Tapa								
Tapa para bandeja 	45 42 110 4 m. 19,90 €/m	45 42 115 4 m. 23,58 €/m	45 42 120 4 m. 28,41 €/m	45 42 130 4 m. 44,62 €/m	45 42 106 8 m. 14,84 €/m	45 42 110 4 m. 19,90 €/m	45 42 115 4 m. 23,58 €/m	45 42 120 4 m. 28,41 €/m
Accesorios								
Tabique separador 		45 72 510 20 m. 12,31 €/m			-			
Brida de unión 		(1) 45 62 110 50 uds. 2,39 €/ud			45 62 110 50 uds. 2,39 €/ud			
4 Brida de unión rápida 		45 61 170 10 uds. 5,01 €/ud			-			
Unión lateral 		45 62 200 25 uds. 2,77 €/ud			-			
2 Unión extensible 		45 65 150 10 uds. 9,31 €/ud			45 65 150 10 uds. 9,31 €/ud			
2 Soporte sujeción y suspensión 		45 71 120 10 uds. 7,55 €/ud	45 71 130 5 uds. 16,19 €/ud		45 71 120 10 uds. 7,55 €/ud			
Suspensión central 		45 52 430 30 uds. 3,62 €/ud			45 52 430 30 uds. 3,62 €/ud			
1 Placa derivación tubos 		45 71 315 10 uds. 4,67 €/ud			45 71 315 10 uds. 4,67 €/ud			
3 Borne puesta a tierra 		45 71 310 10 uds. 18,02 €/ud			45 71 310 10 uds. 18,02 €/ud			
Elevador aislante 		45 71 700 20 uds. 3,55 €/ud			45 71 700 20 uds. 3,55 €/ud			
Tarjeta Rejinorma 		45 51 485 25 uds. 1,17 €/ud			45 51 485 25 uds. 1,17 €/ud			
Herramienta de corte 		45 80 110 1 uds. 386,28 €/ud			45 80 110 1 uds. 386,28 €/ud			

Código **XX XX XXX**
Embalaje 0 uds.
PVR 0,00 €/ud











- 1** Acabado sendzimir.
2 Acabado sendzimir, disponible también en inoxidable.
3 Acabado zincado.

- 4** Acabado zincado, disponible también en bicromatado.
5 Acabado sendzimir. Consultar disponibilidad acabado inoxidable y galvanizado en caliente.







70x300	70x400	70x500	70x600	105x200	105x300	105x400	105x500	105x600
45 12 230 6 m. 34,08 €/m	45 12 240 6 m. 45,87 €/m	45 12 250 6 m. 53,90 €/m	45 12 260 6 m. 62,25 €/m	45 12 320 6 m. 34,22 €/m	45 12 330 6 m. 41,53 €/m	45 12 340 6 m. 54,11 €/m	45 12 350 6 m. 61,80 €/m	45 12 360 6 m. 69,37 €/m
45 42 130 4 m. 44,62 €/m	45 42 140 4 m. 67,51 €/m	45 42 150 4 m. 84,99 €/m	45 42 160 4 m. 98,44 €/m	45 42 120 4 m. 28,41 €/m	45 42 130 4 m. 44,62 €/m	45 42 140 4 m. 67,51 €/m	45 42 150 4 m. 84,99 €/m	45 42 160 4 m. 98,44 €/m
45 72 520 20 m. 14,46 €/m				45 72 530 20 m. 23,70 €/m				
(1) 45 62 110 50 uds. 2,39 €/ud				(1) 45 62 110 50 uds. 2,39 €/ud				
45 61 180 10 uds. 5,41 €/ud				45 61 180 10 uds. 5,41 €/ud				
45 62 205 25 uds. 3,11 €/ud				45 62 205 25 uds. 3,11 €/ud				
45 65 150 10 uds. 9,31 €/ud				45 65 150 10 uds. 9,31 €/ud				
45 71 120 10 uds. 7,55 €/ud	45 71 130 5 uds. 16,19 €/ud				45 71 120 10 uds. 7,55 €/ud	45 71 130 5 uds. 16,19 €/ud		
45 52 430 30 uds. 3,62 €/ud				45 52 430 30 uds. 3,62 €/ud				
45 71 315 10 uds. 4,67 €/ud				45 71 315 10 uds. 4,67 €/ud				
45 71 310 10 uds. 18,02 €/ud				45 71 310 10 uds. 18,02 €/ud				
45 71 700 20 uds. 3,55 €/ud				45 71 700 20 uds. 3,55 €/ud				
45 51 485 25 uds. 1,17 €/ud				45 51 485 25 uds. 1,17 €/ud				
45 80 110 1 uds. 386,28 €/ud				45 80 110 1 uds. 386,28 €/ud				

■ Longitud de bandejas: 3 m.
Longitud de tapas y tabiques: 2 m.

(1) Recomendado como unión central para anchos de:
150 y 200: 1 unidad
300 y 400: 2 unidades
500 y 600: 3 unidades

ACABADO GALVANIZADO EN CALIENTE								
Dimensiones (alto x ancho)	35x100	35x150	35x200	35x300	60x60	70x100	70x150	70x200
Bandejas								
Bandeja 	45 12 110	45 12 115	45 12 120	45 12 130	45 12 206	45 12 210	45 12 215	45 12 220
Soportería								
1 Soporte horizontal rápido 	45 50 110 10 uds. 8,68 €/ud	45 50 111 10 uds. 9,46 €/ud	45 50 112 10 uds. 11,00 €/ud	45 50 113 10 uds. 13,60 €/ud	-	45 50 110 10 uds. 8,68 €/ud	45 50 111 10 uds. 9,46 €/ud	45 50 112 10 uds. 11,00 €/ud
Soporte horizontal "FR" 	45 52 110 10 uds. 10,33 €/ud	45 52 115 10 uds. 11,28 €/ud	45 52 120 10 uds. 12,63 €/ud	45 52 130 10 uds. 18,89 €/ud	-	45 52 110 10 uds. 11,88 €/ud	45 52 115 10 uds. 12,97 €/ud	45 52 120 10 uds. 14,52 €/ud
Consola "FR" 	45 52 910 10 uds. 11,87 €/ud	45 52 915 10 uds. 12,95 €/ud	45 52 920 10 uds. 14,51 €/ud	45 52 930 10 uds. 17,71 €/ud	-	45 52 910 10 uds. 11,87 €/ud	45 52 915 10 uds. 12,95 €/ud	45 52 920 10 uds. 14,51 €/ud
1 Soporte Omega horizontal "FR" 	45 51 310 10 uds. 7,82 €/ud	45 51 315 10 uds. 8,50 €/ud	45 51 320 10 uds. 9,06 €/ud	45 51 330 10 uds. 10,96 €/ud	-	45 51 310 10 uds. 7,82 €/ud	45 51 315 10 uds. 8,50 €/ud	45 51 320 10 uds. 9,06 €/ud
3 Conjunto soporte horizontal "FR" 	45 51 210 2 uds. 12,00 €/ud	45 51 215 2 uds. 13,69 €/ud	45 51 220 2 uds. 15,80 €/ud	45 51 230 2 uds. 18,33 €/ud	-	45 51 210 2 uds. 12,00 €/ud	45 51 215 2 uds. 13,69 €/ud	45 51 220 2 uds. 15,80 €/ud
2 Conjunto soporte orientable "FR" 	45 51 510 2 uds. 17,06 €/ud	45 51 515 2 uds. 18,96 €/ud	45 51 520 2 uds. 20,56 €/ud	45 51 530 2 uds. 28,06 €/ud	-	45 51 510 2 uds. 17,06 €/ud	45 51 515 2 uds. 18,96 €/ud	45 51 520 2 uds. 20,56 €/ud
1 Soporte omega suspensión "FR" 	45 50 410 4 uds. 12,66 €/ud	45 50 415 4 uds. 13,60 €/ud	45 50 420 4 uds. 14,41 €/ud	45 50 430 4 uds. 16,55 €/ud	-	45 50 410 4 uds. 12,66 €/ud	45 50 415 4 uds. 13,60 €/ud	45 50 420 4 uds. 14,41 €/ud
Soporte vertical suspensión "FR" 	45 52 310 10 uds. 10,60 €/ud	45 52 315 10 uds. 11,66 €/ud	45 52 320 10 uds. 12,18 €/ud	45 52 330 10 uds. 14,81 €/ud	-	45 52 310 10 uds. 10,60 €/ud	45 52 315 10 uds. 11,66 €/ud	45 52 320 10 uds. 12,18 €/ud
1 Soporte suspensión reforzado 	-	-	45 51 620 4 uds. 11,12 €/ud	45 51 630 4 uds. 12,02 €/ud	-	-	-	45 51 620 4 uds. 11,12 €/ud

Soportería común a todas las dimensiones de bandejas

Fijación rápida "FR" Rejinorma 	45 61 160 25 uds. 1,00 €/ud	Perfil en "U" 	45 52 420 4 uds. 35,20 €/m	Conjunto varilla 	Ver pág. 83	
Brida fijación Rejinorma 	45 62 120 50 uds. 1,74 €/ud	Soporte en "C" 	45 52 440 10 uds. 6,89 €/ud	4 Grapa tornillo viga 	45 71 408 10 uds. 17,80 €/ud	45 71 410 10 uds. 17,80 €/ud
Soporte basculante 	45 52 410 4 uds. 16,80 €/ud	Soporte suspensión en "L" 	45 52 450 10 uds. 6,89 €/ud	5 Grapa horizontal suspensión 	45 71 416 20 uds. 3,98 €/ud	45 71 418 20 uds. 3,83 €/ud

Código **XX XX XXX**
Embalaje 0 uds.
PVR 0,00 €/ud

- 1 Acabado sendzimir.
- 2 Acabado sendzimir, disponible también en inoxidable.
- 3 Acabado sendzimir. Consultar disponibilidad acabado inoxidable y galvanizado en caliente.

70x300	70x400	70x500	70x600	105x200	105x300	105x400	105x500	105x600
45 12 230	45 12 240	45 12 250	45 12 260	45 12 320	45 12 330	45 12 340	45 12 350	45 12 360
45 52 130 10 uds. 16,43 €/ud	45 50 114 10 uds. 19,69 €/ud	45 50 115 10 uds. 22,61 €/ud	45 50 116 10 uds. 27,50 €/ud	45 50 112 10 uds. 11,00 €/ud	45 50 113 10 uds. 13,60 €/ud	45 50 114 10 uds. 19,69 €/ud	45 50 115 10 uds. 22,61 €/ud	45 50 116 10 uds. 27,50 €/ud
45 52 130 10 uds. 18,89 €/ud	45 52 140 5 uds. 25,28 €/ud	45 52 150 5 uds. 30,69 €/ud	45 52 160 5 uds. 33,95 €/ud	45 52 120 10 uds. 14,52 €/ud	45 52 130 10 uds. 18,89 €/ud	45 52 140 5 uds. 25,28 €/ud	45 52 150 5 uds. 30,69 €/ud	45 52 160 5 uds. 33,95 €/ud
45 52 930 10 uds. 17,71 €/ud	45 52 940 4 uds. 21,54 €/ud	45 52 950 4 uds. 27,90 €/ud	45 52 960 4 uds. 31,21 €/ud	45 52 920 10 uds. 14,51 €/ud	45 52 930 10 uds. 17,71 €/ud	45 52 940 4 uds. 21,54 €/ud	45 52 950 4 uds. 27,90 €/ud	45 52 960 4 uds. 31,21 €/ud
45 51 330 10 uds. 10,96 €/ud	-	-	-	45 51 320 10 uds. 9,06 €/ud	45 51 330 10 uds. 10,96 €/ud	-	-	-
45 51 230 2 uds. 18,33 €/ud	45 51 240 2 uds. 21,19 €/ud	45 51 250 2 uds. 27,54 €/ud	45 51 260 2 uds. 32,98 €/ud	45 51 220 2 uds. 15,80 €/ud	45 51 230 2 uds. 18,33 €/ud	45 51 240 2 uds. 21,19 €/ud	45 51 250 2 uds. 27,54 €/ud	45 51 260 2 uds. 32,98 €/ud
45 51 530 2 uds. 28,06 €/ud	45 51 540 2 uds. 32,51 €/ud	45 51 550 2 uds. 38,11 €/ud	45 51 560 2 uds. 42,12 €/ud	45 51 520 2 uds. 20,56 €/ud	45 51 530 2 uds. 28,06 €/ud	45 51 540 2 uds. 32,51 €/ud	45 51 550 2 uds. 38,11 €/ud	45 51 560 2 uds. 42,12 €/ud
45 50 430 4 uds. 16,55 €/ud	-	-	-	45 50 420 4 uds. 14,41 €/ud	45 50 430 4 uds. 16,55 €/ud	-	-	-
45 52 330 10 uds. 14,81 €/ud	45 52 340 5 uds. 17,68 €/ud	45 52 350 5 uds. 21,29 €/ud	45 52 360 5 uds. 25,16 €/ud	45 52 320 10 uds. 12,18 €/ud	45 52 330 10 uds. 14,81 €/ud	45 52 340 5 uds. 17,68 €/ud	45 52 350 5 uds. 21,29 €/ud	45 52 360 5 uds. 25,18 €/ud
45 51 630 4 uds. 12,02 €/ud	45 51 640 4 uds. 15,06 €/ud	45 51 650 4 uds. 19,43 €/ud	45 51 660 4 uds. 21,74 €/ud	45 51 620 4 uds. 11,12 €/ud	45 51 630 4 uds. 12,02 €/ud	45 51 640 4 uds. 15,06 €/ud	45 51 650 4 uds. 19,43 €/ud	45 51 660 4 uds. 21,74 €/ud

Grapa horizontal suspensión 	45 71 436 20 uds. 4,76 €/ud	45 71 438 20 uds. 4,40 €/ud
Perfiles troquelados 	Ver pág. 86	

Tornillos de fijación M6x12 	47 21 912 150/50 uds. 0,39 €/ud
Tornillos de fijación M6x20 	45 71 110 150/50 uds. 0,44 €/ud

Tuercas reforzadas y con muelle 	Ver pág. 87
Tuercas cuadradas 	Ver pág. 87









ACABADO INOXIDABLE								
Dimensiones (alto x ancho)	35x100	35x150	35x200	35x300	60x60	70x100	70x150	70x200
								
Bandejas								
Bandeja 	45 15 110 24 m. 40,55 €/m	45 15 115 12 m. 56,13 €/m	45 15 120 12 m. 62,41 €/m	45 15 130 12 m. 82,69 €/m	45 15 206 24 m. 40,98 €/m	45 15 210 12 m. 55,77 €/m	45 15 215 12 m. 65,99 €/m	45 15 220 6 m. 75,97 €/m
Tapa								
Tapa para bandeja 	45 45 110 4 m. 60,07 €/m	45 45 115 4 m. 77,71 €/m	45 45 120 4 m. 90,42 €/m	45 45 130 4 m. 124,73 €/m	45 45 106 8 m. 41,07 €/m	45 45 110 4 m. 60,07 €/m	45 45 115 4 m. 77,71 €/m	45 45 120 4 m. 90,42 €/m
Accesorios								
Tabique separador 		45 75 510 20 m. 20,35 €/m			-			
Brida de unión 		(1) 45 65 110 50 uds. 4,20 €/ud			45 65 110 50 uds. 4,20 €/ud			
Unión lateral 		45 65 200 25 uds. 3,85 €/ud			-			
Unión extensible 		45 65 150 10 uds. 11,08 €/ud			45 65 150 10 uds. 11,08 €/ud			
Soporte sujeción y suspensión 		45 75 120 10 uds. 12,73 €/ud	45 75 130 5 uds. 22,26 €/ud		45 75 120 10 uds. 12,73 €/ud			
Suspensión central 		45 55 430 30 uds. 4,25 €/ud			45 55 430 30 uds. 4,25 €/ud			
1 Placa derivación tubos 		45 71 315 10 uds. 4,67 €/ud			45 71 315 10 uds. 4,67 €/ud			
4 Borne puesta a tierra 		45 71 310 10 uds. 18,02 €/ud			45 71 310 10 uds. 18,02 €/ud			
Elevador aislante 		45 71 700 20 uds. 3,55 €/ud			45 71 700 20 uds. 3,55 €/ud			
Tarjeta Rejinorma 		45 51 485 25 uds. 1,39 €/ud			45 51 485 25 uds. 1,39 €/ud			
Herramienta de corte 		45 80 110 1 uds. 386,28 €/ud			45 80 110 1 uds. 386,28 €/ud			

Código **XX XX XXX**
Embalaje 0 uds.
PVR 0,00 €/ud

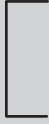
- 1** Acabado sendzimir.
4 Acabado zincado.

- Longitud de bandejas: 3 m.
Longitud de tapas y tabiques: 2 m.

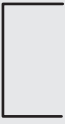
- (1)** Recomendado como unión central para anchos de:
150 y 200: 1 unidad
300 y 400: 2 unidades
500 y 600: 3 unidades

70x300	70x400	70x500	70x600	105x200	105x300	105x400	105x500	105x600
								
45 15 230 6 m. 95,40 €/m	45 15 240 6 m. 125,88 €/m	45 15 250 6 m. 150,12 €/m	45 15 260 6 m. 175,48 €/m	45 15 320 6 m. 99,77 €/m	45 15 330 6 m. 119,67 €/m	45 15 340 6 m. 152,33 €/m	45 15 350 6 m. 173,39 €/m	45 15 360 6 m. 197,63 €/m
45 45 130 4 m. 124,73 €/m	45 45 140 4 m. 138,72 €/m	45 45 150 4 m. 204,58 €/m	45 45 160 4 m. 239,22 €/m	45 45 120 4 m. 90,42 €/m	45 45 130 4 m. 124,73 €/m	45 45 140 4 m. 138,72 €/m	45 45 150 4 m. 204,58 €/m	45 45 160 4 m. 239,22 €/m
45 75 520 20 m. 30,51 €/m				45 75 530 20 m. 50,79 €/m				
(1) 45 65 110 50 uds. 4,20 €/ud				(1) 45 65 110 50 uds. 4,20 €/ud				
45 65 205 25 uds. 5,03 €/ud				45 65 205 25 uds. 5,03 €/ud				
45 65 150 10 uds. 11,08 €/ud				45 65 150 10 uds. 11,08 €/ud				
45 75 130 5 uds. 22,26 €/ud				45 75 120 10 uds. 12,73 €/ud		45 75 130 5 uds. 22,26 €/ud		
45 55 430 30 uds. 4,25 €/ud				45 55 430 30 uds. 4,25 €/ud				
45 71 315 10 uds. 4,67 €/ud				45 71 315 10 uds. 4,67 €/ud				
45 71 310 10 uds. 18,02 €/ud				45 71 310 10 uds. 18,02 €/ud				
45 71 700 20 uds. 3,55 €/ud				45 71 700 20 uds. 3,55 €/ud				
45 51 485 25 uds. 1,39 €/ud				45 51 485 25 uds. 1,39 €/ud				
45 80 110 1 uds. 386,28 €/ud				45 80 110 1 uds. 386,28 €/ud				

ACABADO INOXIDABLE								
Dimensiones (alto x ancho)	35x100	35x150	35x200	35x300	60x60	70x100	70x150	70x200
Bandejas								
Bandeja 	45 15 110	45 15 115	45 15 120	45 15 130	45 15 206	45 15 210	45 15 215	45 15 220
Soportería								
1 Soporte horizontal rápido 	45 50 110 10 uds. 8,33 €/ud	45 50 111 10 uds. 9,08 €/ud	45 50 112 10 uds. 10,56 €/ud	45 50 113 10 uds. 13,06 €/ud	-	45 50 110 10 uds. 8,33 €/ud	45 50 111 10 uds. 9,08 €/ud	45 50 112 10 uds. 10,56 €/ud
Soporte horizontal "FR" 	45 55 110 10 uds. 26,12 €/ud	45 55 115 10 uds. 32,32 €/ud	45 55 120 10 uds. 40,68 €/ud	45 55 130 10 uds. 52,15 €/ud	-	45 55 110 10 uds. 26,12 €/ud	45 55 115 10 uds. 32,32 €/ud	45 55 120 10 uds. 40,68 €/ud
Consola "FR" 	45 55 910 10 uds. 25,16 €/ud	45 55 915 10 uds. 32,92 €/ud	45 55 920 10 uds. 40,68 €/ud	45 55 930 10 uds. 59,33 €/ud	-	45 55 910 10 uds. 25,16 €/ud	45 55 915 10 uds. 32,92 €/ud	45 55 920 10 uds. 40,68 €/ud
3 Conjunto soporte horizontal "FR" 	45 51 210 2 uds. 11,52 €/ud	45 51 215 2 uds. 13,14 €/ud	45 51 220 2 uds. 15,17 €/ud	45 51 230 2 uds. 17,59 €/ud	-	45 51 210 2 uds. 11,52 €/ud	45 51 215 2 uds. 13,14 €/ud	45 51 220 2 uds. 15,17 €/ud
2 Conjunto soporte orientable "FR" 	45 51 510 2 uds. 17,78 €/ud	45 51 515 2 uds. 19,75 €/ud	45 51 520 2 uds. 21,41 €/ud	45 51 530 2 uds. 29,23 €/ud	-	45 51 510 2 uds. 17,78 €/ud	45 51 515 2 uds. 19,75 €/ud	45 51 520 2 uds. 21,41 €/ud
Soporte vertical suspensión "FR" 	45 55 310 10 uds. 19,96 €/ud	45 55 315 10 uds. 21,93 €/ud	45 55 320 10 uds. 26,54 €/ud	45 55 330 10 uds. 30,42 €/ud	-	45 55 310 10 uds. 19,96 €/ud	45 55 315 10 uds. 21,93 €/ud	45 55 320 10 uds. 26,54 €/ud

Soportería común a todas las dimensiones de bandejas

Fijación rápida "FR" Rejinorma 	45 61 160 25 uds. 1,00 €/ud	Perfil en "U" 	45 55 420 4 uds. 88,82 €/ud	Conjunto varilla 	Ver pág. 83	
Brida fijación Rejinorma 	45 65 120 50 uds. 3,07 €/ud	Soporte en "C" 	45 55 440 10 uds. 6,66 €/ud	4 Grapa tornillo viga 	45 71 408 10 uds. 17,80 €/ud	45 71 410 10 uds. 17,80 €/ud
Soporte basculante 	45 55 410 8 uds. 37,07 €/ud	Soporte suspensión en "L" 	45 55 450 10 uds. 6,66 €/ud	5 Grapa horizontal suspensión 	45 71 416 20 uds. 3,98 €/ud	45 71 418 20 uds. 3,83 €/ud

Código	XX XX XXX
Embalaje	0 uds.
PVR	0,00 €/ud

- 1 Acabado sendzimir.
- 2 Acabado sendzimir, disponible también en inoxidable.
- 3 Acabado sendzimir, disponible también en galvanizado en caliente e inoxidable.

- 4 Acabado zincado.
- 5 Acabado fosfatado-zn.
- 6 Acabado sendzimir, disponible también en zincado.

70x300	70x400	70x500	70x600	105x200	105x300	105x400	105x500	105x600
45 15 230	45 15 240	45 15 250	45 15 260	45 15 320	45 15 330	45 15 340	45 15 350	45 15 360
45 50 113 10 uds. 13,06 €/ud	45 50 114 10 uds. 18,90 €/ud	45 50 115 10 uds. 21,71 €/ud	45 50 116 10 uds. 26,40 €/ud	45 50 112 10 uds. 11,00 €/ud	45 50 113 10 uds. 13,60 €/ud	45 50 114 10 uds. 19,69 €/ud	45 50 115 10 uds. 22,61 €/ud	45 50 116 10 uds. 27,50 €/ud
45 55 130 10 uds. 52,15 €/ud	45 55 140 5 uds. 69,63 €/ud	45 55 150 5 uds. 84,55 €/ud	45 55 160 5 uds. 99,46 €/ud	45 55 120 10 uds. 40,68 €/ud	45 55 130 10 uds. 52,15 €/ud	45 55 140 5 uds. 69,63 €/ud	45 55 150 5 uds. 84,55 €/ud	45 55 160 5 uds. 99,46 €/ud
45 55 930 10 uds. 59,33 €/ud	45 55 940 5 uds. 66,45 €/ud	45 55 950 5 uds. 94,10 €/ud	45 55 960 5 uds. 104,56 €/ud	45 55 920 10 uds. 40,68 €/ud	45 55 930 10 uds. 59,33 €/ud	45 55 940 5 uds. 66,45 €/ud	45 55 950 5 uds. 94,10 €/ud	45 55 960 5 uds. 104,56 €/ud
45 51 230 2 uds. 17,59 €/ud	45 51 240 2 uds. 20,34 €/ud	45 51 250 2 uds. 26,44 €/ud	45 51 260 2 uds. 31,66 €/ud	45 51 220 2 uds. 15,17 €/ud	45 51 230 2 uds. 17,59 €/ud	45 51 240 2 uds. 20,34 €/ud	45 51 250 2 uds. 26,44 €/ud	45 51 260 2 uds. 31,66 €/ud
45 51 530 2 uds. 29,23 €/ud	45 51 540 2 uds. 33,86 €/ud	45 51 550 2 uds. 39,70 €/ud	45 51 560 2 uds. 43,88 €/ud	45 51 520 2 uds. 21,41 €/ud	45 51 530 2 uds. 29,23 €/ud	45 51 540 2 uds. 33,86 €/ud	45 51 550 2 uds. 39,70 €/ud	45 51 560 2 uds. 43,88 €/ud
45 55 330 10 uds. 30,42 €/ud	45 55 340 5 uds. 41,64 €/ud	45 55 350 5 uds. 61,33 €/ud	45 55 360 5 uds. 70,52 €/ud	45 55 320 10 uds. 26,54 €/ud	45 55 330 10 uds. 30,42 €/ud	45 55 340 5 uds. 41,64 €/ud	45 55 350 5 uds. 61,33 €/ud	45 55 360 5 uds. 70,52 €/ud

5 Grapa horizontal suspensión		45 71 436 20 uds. 4,76 €/ud	45 71 438 20 uds. 4,40 €/ud
6 Perfiles troquelados		Ver pág. 86	

Tornillos de fijación M6x12		47 25 912 50 uds. 1,31 €/ud
Tornillos de fijación M6x20		45 75 110 50 uds. 1,41 €/ud
Tornillos de fijación M8x20		43 26 605 50 uds. 1,29 €/ud

Tuercas reforzadas y con muelle		Ver pág. 87
Tuercas cuadradas		Ver pág. 87

BANDEJA



Bandeja	ZINCADA		BRICOMATADA		GALV. CALIENTE		INOXIDABLE		M.Emb.	Dimensiones (mm)	
	Ref.	P.V.R. €/m	Ref.	P.V.R. €/m	Ref.	P.V.R. €/m	Ref.	P.V.R. €/m		A	B
35x100	45 11 110	8,48	45 16 110	8,48	45 12 110	11,21	45 15 110	40,55	24	40	100
35x150	45 11 115	10,50	45 16 115	10,50	45 12 115	15,01	45 15 115	56,13	12	40	150
35x200	45 11 120	12,22	45 16 120	12,22	45 12 120	17,08	45 15 120	62,41	12	40	200
35x300	45 11 130	16,43	45 16 130	16,43	45 12 130	23,24	45 15 130	82,69	12	40	300
60x60	45 11 206	8,97	45 16 206	8,97	45 12 206	12,56	45 15 206	40,98	24	65	60
70x100	45 11 210	11,21	45 16 210	11,21	45 12 210	16,35	45 15 210	55,77	12	75	100
70x150	45 11 215	13,35	45 16 215	13,35	45 12 215	18,03	45 15 215	65,99	12	75	150
70x200	45 11 220	16,43	45 16 220	16,43	45 12 220	22,36	45 15 220	75,96	6	75	200
70x300	45 11 230	22,22	45 16 230	22,22	45 12 230	34,08	45 15 230	95,40	6	75	300
70x400	45 11 240	31,34	45 16 240	31,34	45 12 240	45,87	45 15 240	125,88	6	75	400
70x500	45 11 250	36,51	45 16 250	36,51	45 12 250	53,90	45 15 250	150,12	6	75	500
70x600	45 11 260	42,93	45 16 260	42,93	45 12 260	62,25	45 15 260	175,48	6	75	600
105x200	45 11 320	25,39	45 16 320	25,39	45 12 320	34,22	45 15 320	99,77	6	110	200
105x300	45 11 330	30,83	45 16 330	30,83	45 12 330	41,53	45 15 330	119,67	6	110	300
105x400	45 11 340	36,71	45 16 340	36,71	45 12 340	54,11	45 15 340	152,33	6	110	400
105x500	45 11 350	42,27	45 16 350	42,27	45 12 350	61,80	45 15 350	173,39	6	110	500
105x600	45 11 360	47,62	45 16 360	47,62	45 12 360	69,37	45 15 360	197,63	6	110	600

■ Longitud 3 m.

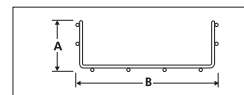

TAPA



Tapa	SENDZIMIR		GALV. CALIENTE		INOXIDABLE		M.Emb.	Dimensiones (mm)	
	Ref.	P.V.R. €/m	Ref.	P.V.R. €/m	Ref.	P.V.R. €/m		A	B
Para ancho 60	45 41 106	8,76	45 42 106	14,84	45 45 106	43,12	8	20	60
Para ancho 100	45 41 110	10,11	45 42 110	19,90	45 45 110	60,07	4	20	100
Para ancho 150	45 41 115	11,35	45 42 115	23,58	45 45 115	77,71	4	20	150
Para ancho 200	45 41 120	13,21	45 42 120	28,41	45 45 120	90,42	4	20	200
Para ancho 300	45 41 130	21,75	45 42 130	44,62	45 45 130	124,73	4	20	300
Para ancho 400	45 41 140	27,51	45 42 140	67,51	45 45 140	138,72	4	20	400
Para ancho 500	45 41 150	36,44	45 42 150	84,99	45 45 150	204,58	4	20	500
Para ancho 600	45 41 160	40,74	45 42 160	98,44	45 45 160	239,22	4	20	600

■ Longitud 2 m.

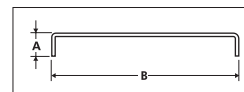

TABIQUE SEPARADOR



Tabique	SENDZIMIR		GALV. CALIENTE		INOXIDABLE		M.Emb.
	Ref.	P.V.R. €/m	Ref.	P.V.R. €/m	Ref.	P.V.R. €/m	
Para ala 35	45 71 510	7,00	45 72 510	12,31	45 75 510	20,35	20
Para ala 70	45 71 520	8,23	45 72 520	14,46	45 75 520	30,51	20
Para ala 105	45 71 530	13,49	45 72 530	23,71	45 75 530	50,59	20

■ Longitud 2 m.

Dimensiones (mm)	
A	B
20	60
20	100
20	150

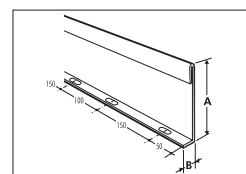

BRIDA DE UNIÓN



45 61 110

Unión	ZINCADA		BRICOMATADA		GALV. CALIENTE		INOXIDABLE		U.Emb.
	Ref.	P.V.R. €/ud	Ref.	P.V.R. €/ud	Ref.	P.V.R. €/ud	Ref.	P.V.R. €/ud	
	45 61 110	1,69	45 66 110	1,69	45 62 110	2,39	45 65 110	4,20	50

■ Complemento recomendado para las bridas de unión lateral.
Se aconseja completar la unión lateral, con 1 brida de unión para bandejas 150 y 200, con 2 brida de unión para bandejas 300 y 400, con 3 brida de unión para bandejas 500 y 600.

Dimensiones (mm)		Apriete (N.m)
A	B	
23,5	23,5	12

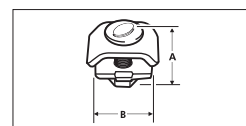

BRIDA DE UNIÓN RÁPIDA



45 66 1X0 / 45 61 1X0

Brida de unión rápida	ZINCADA		BRICOMATADA		U.Emb.
	Ref.	P.V.R. €/ud	Ref.	P.V.R. €/ud	
Para ala 35	45 61 170	4,81	45 66 170	4,81	10
Para ala 70/105	45 61 180	5,20	45 66 180	5,20	10

Dimensiones (mm)	
A	B
22	141,1
30	141,1

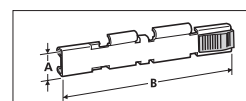

UNIÓN LATERAL



45 66 2XX

Brida lateral	ZINCADA		BRICOMATADA		GALV. CALIENTE		INOXIDABLE		U.Emb.
	Ref.	P.V.R. €/ud	Ref.	P.V.R. €/ud	Ref.	P.V.R. €/ud	Ref.	P.V.R. €/ud	
Para ala 35	45 61 200	1,93	45 66 200	1,93	45 62 200	2,77	45 65 200	3,85	25
Para ala 70/105	45 61 205	2,16	45 66 205	2,16	45 62 205	3,11	45 65 205	5,03	25

■ Se suministra completa.

Dimensiones (mm)

A	B
32	80
46	80

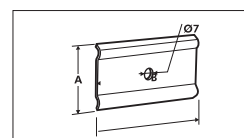

SUSPENSIÓN CENTRAL



45 51 430

Suspensión	ZINCADA		BRICOMATADA		GALV. CALIENTE		INOXIDABLE		U.Emb.
	Ref.	P.V.R. €/ud	Ref.	P.V.R. €/ud	Ref.	P.V.R. €/ud	Ref.	P.V.R. €/ud	
	45 51 430	1,56	45 56 430	1,56	45 52 430	3,62	45 55 430	4,25	30

■ Se necesitan 2 unidades por suspensión.

Dimensiones (mm)

A	B	Ø C
60	40	8,5

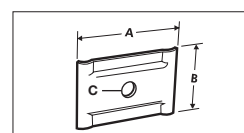

UNIÓN EXTENSIBLE



45 61 150

Unión extensible	SENDZIMIR		INOXIDABLE		U.Emb.
	Ref.	P.V.R. €/ud	Ref.	P.V.R. €/ud	
	45 61 150	3,79	45 65 150	9,31	10

■ Se suministra completa.

Dimensiones (mm)

A	B
300	17

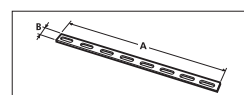

SOPORTE SUJECIÓN Y SUSPENSIÓN



45 71 120



45 71 130

Soporte sujeción y suspensión	SENDZIMIR		INOXIDABLE		U.Emb.
	Ref.	P.V.R. €/ud	Ref.	P.V.R. €/ud	
Simple	45 71 120	7,25	45 75 120	12,73	10
Doble	45 71 130	15,54	45 75 130	22,26	5

Dimensiones (mm)

A	B
92	72
182	100

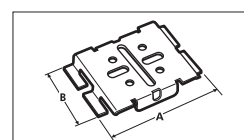

PLACA DERIVACIÓN TUBOS



45 71 315

SENDZIMIR		
Ref.	P.V.R. €/ud	U.Emb.
45 71 315	4,67	10

Placa derivación tubos

Dimensiones (mm)		Diámetro		
A	B	C	D	E
85	146	32	25	20

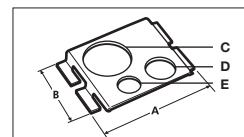

BORNE DE PUESTA A TIERRA



45 71 310

ZINCADA		
Ref.	P.V.R. €/ud	U.Emb.
45 71 310	18,02	10

Borne de puesta a tierra

Dimensiones (mm)		Máx. Capacidad (mm²)
A	B	
120	44	1x70

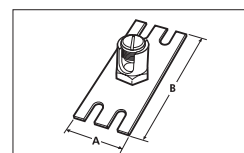

ELEVADOR AISLANTE



45 71 700

Ref.	P.V.R. €/ud	U.Emb.
45 71 700	2,98	20

Elevador aislante

■ Se recomienda engarzar a las 4 varillas, no separar más de 1 m. y no cargar más de 100 kg. por elevador.

Dimensiones (mm)		
A	B	C
85	44,5	45

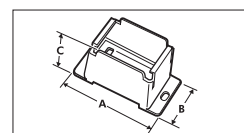

TARJETA REJINORMA



45 51 485

Ref.	P.V.R. €/ud	U.Emb.
45 51 485	1,39	25

Tarjeta

Dimensiones exteriores (mm)
100x30

HERRAMIENTA DE CORTE



45 80 110

Ref.	P.V.R. €/ud	U.Emb.
45 80 110	386,28	1

Herramienta

Dimensiones (mm)	
A	B
470	130

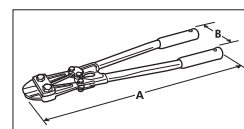

PROTECTOR RETOQUES



45 80 130

	ZINCADA		BRICOMATADA		U.Emb.
	Ref.	P.V.R. €/ud	Ref.	P.V.R. €/ud	
Protector	45 80 130	127,82	45 80 131	156,20	1

Capacidad (ml)
500/400

FIJACIÓN RÁPIDA "FR" REJINORMA



45 61 160

Fijación

- Se puede montar sobre cualquier soporte del tipo FR; convirtiéndolo en un soporte de fijación rápida.

Ref.	P.V.R. €/ud	U.Emb.
45 61 160	1,00	25

Dimensiones (mm)		
A	B	C
17,9	17,7	14

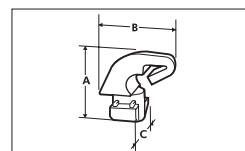

BRIDA FIJACIÓN REJINORMA



45 61 120

	ZINCADA		BRICOMATADA		GALV. CALIENTE		INOXIDABLE		U.Emb.
	Ref.	P.V.R. €/ud	Ref.	P.V.R. €/ud	Ref.	P.V.R. €/ud	Ref.	P.V.R. €/ud	
Bridas	45 61 120	1,24	45 66 120	1,24	45 62 120	1,74	45 65 120	3,07	50

Dimensiones (mm)	
A	B
23,5	23,5

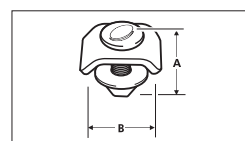

SOPORTE HORIZONTAL RÁPIDO



45 61 120

Soporte horizontal rápido

	SENDZIMIR		
	Ref.	P.V.R. €/ud	U.Emb.
Para bandeja ancho 100	45 50 110	8,33	10
Para bandeja ancho 150	45 50 111	9,08	10
Para bandeja ancho 200	45 50 112	10,56	10
Para bandeja ancho 300	45 50 113	13,06	10
Para bandeja ancho 400	45 50 114	18,90	5
Para bandeja ancho 500	45 50 115	21,71	5
Para bandeja ancho 600	45 50 116	26,40	5

Dimensiones (mm)		
A	B	C
144	82	42
194	82	42
244	82	42
344	82	42
444	130	42
544	130	42
644	130	42

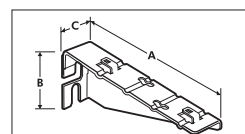

SOPORTE HORIZONTAL "FR"



45 51 1XX

Soporte	SENDZIMIR		GALVANIZADO CALIENTE		INOXIDABLE		U.Emb.
	Ref.	P.V.R. €/ud	Ref.	P.V.R. €/ud	Ref.	P.V.R. €/ud	
Para bandeja ancho 100	45 51 110	7,58	45 52 110	10,33	45 55 110	26,12	10
Para bandeja ancho 150	45 51 115	8,72	45 52 115	11,28	45 55 115	32,32	10
Para bandeja ancho 200	45 51 120	10,34	45 52 120	12,63	45 55 120	40,68	10
Para bandeja ancho 300	45 51 130	12,80	45 52 130	18,89	45 55 130	52,15	10
Para bandeja ancho 400	45 51 140	18,91	45 52 140	25,28	45 55 140	69,63	5
Para bandeja ancho 500	45 51 150	21,28	45 52 150	30,69	45 55 150	84,55	5
Para bandeja ancho 600	45 51 160	24,26	45 52 160	33,95	45 55 160	99,46	5

Dimensiones (mm)		
A	B	C
144	82	42
194	82	42
244	82	42
344	82	42
444	130	42
544	130	42
644	130	42

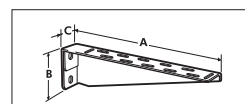

SOPORTE BASCULANTE



45 51 410

Soporte	SENDZIMIR		GALVANIZADO CALIENTE		INOXIDABLE		U.Emb.
	Ref.	P.V.R. €/ud	Ref.	P.V.R. €/ud	Ref.	P.V.R. €/ud	
	45 51 410	11,30	45 52 410	16,80	45 55 410	37,07	8

Dimensiones (mm)			
A	B	C	D
116	150	60	100

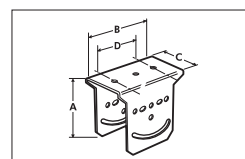

PERFIL EN "U"



45 51 420

Perfil en "U"	SENDZIMIR		GALVANIZADO CALIENTE		INOXIDABLE		U.Emb.
	Ref.	P.V.R. €/m	Ref.	P.V.R. €/m	Ref.	P.V.R. €/m	
	45 51 420	25,22	45 52 420	35,20	45 55 420	88,82	4

Dimensiones (mm)		
A	B	C
1000	55	30

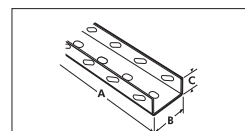

■ Longitud: 1 m.

CONSOLA "FR"



45 61 9XX

Consolas "FR"

	SENDZIMIR			GALVANIZADO CALIENTE		INOXIDABLE		U.Emb.
	Ref.	P.V.R. €/ud	U.Emb.	Ref.	P.V.R. €/ud	Ref.	P.V.R. €/ud	
Para bandeja ancho 100	45 51 910	8,57	10	45 52 910	11,87	45 55 910	25,16	10
Para bandeja ancho 150	45 51 915	9,29	10	45 52 915	12,95	45 55 915	32,92	10
Para bandeja ancho 200	45 51 920	10,46	10	45 52 920	14,51	45 55 920	40,68	10
Para bandeja ancho 300	45 51 930	13,31	10	45 52 930	17,71	45 55 930	59,33	10
Para bandeja ancho 400	45 51 940	16,03	4	45 52 940	21,54	45 55 940	66,45	4
Para bandeja ancho 500	45 51 950	18,70	4	45 52 950	27,90	45 55 950	94,10	4
Para bandeja ancho 600	45 51 960	23,27	4	45 52 960	31,21	45 55 960	104,56	4

Dimensiones (mm)

A	B	C
160	87	50
210	87	50
260	87	50
360	94,25	50
460	100	50
560	110	50
660	110	50

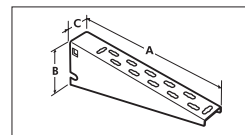

SOPORTE EN "C"



45 52 440

	SENDZIMIR		GALVANIZADO CALIENTE		INOXIDABLE		U.Emb.
	Ref.	P.V.R. €/ud	Ref.	P.V.R. €/ud	Ref.	P.V.R. €/ud	
SopORTE en "C"	45 51 440	4,15	45 52 440	6,89	45 55 440	6,66	10

Dimensiones (mm)

A	B	C
70	36	39

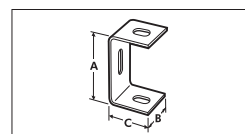

SOPORTE SUSPENSIÓN EN "L"



45 51 450

	SENDZIMIR		GALVANIZADO CALIENTE		INOXIDABLE		U.Emb.
	Ref.	P.V.R. €/ud	Ref.	P.V.R. €/ud	Ref.	P.V.R. €/ud	
SopORTE en "L"	45 51 450	4,15	45 52 450	6,89	45 55 450	6,66	10

Dimensiones (mm)

A	B	C
104	36	39

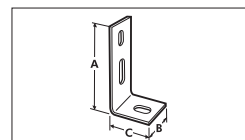

CONJUNTO VARILLA



45 51 4XX

Conjunto varilla	SENDZIMIR		INOXIDABLE		U.Emb.
	Ref.	P.V.R. €/ud	Ref.	P.V.R. €/ud	
M6-10 longitud 1 m.	45 51 467	4,74	-	-	10
M8-05 longitud 0,5 m.	45 51 470	3,37	45 55 470	12,85	10
M8-10 longitud 1 m.	45 51 480	6,01	45 55 480	24,01	10
Conector varilla M6	45 51 481	2,88	-	-	50
Conector varilla M8	45 51 482	3,40	-	-	50

■ Se suministran completos.

Dimensiones (mm)	
A	B
1000	M-6
500	M-8
1000	M-8
500	M-6
1000	M-8

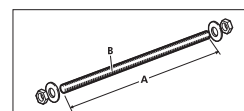

SOPORTE OMEGA HORIZONTAL "FR"



(1)

45 50 3XX

Soporte	SENDZIMIR		
	Ref.	P.V.R. €/ud	U.Emb.
Para ancho 100	45 50 310	6,54	10
Para ancho 150	45 50 315	6,92	10
Para ancho 200	45 50 320	8,27	10
Para ancho 300	45 50 330	9,45	10

(1) Refuerzo antiplastamiento. Se suministra junto con el soporte vertical-suspensión "FR".

Dimensiones (mm)				Carga (Kg)
A	B	C	D	
150	131	50	23	313,5
200	131	50	23	159,2
250	131	50	23	109,2
350	131	50	23	90

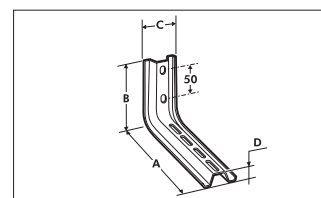

CONJUNTO SOPORTE HORIZONTAL "FR"



45 51 2XX

Conjunto	SENDZIMIR		
	Ref.	P.V.R. €/ud	U.Emb.
Para bandeja ancho 100	45 51 210	11,52	2
Para bandeja ancho 150	45 51 215	13,14	2
Para bandeja ancho 200	45 51 220	15,17	2
Para bandeja ancho 300	45 51 230	17,59	2
Para bandeja ancho 400	45 51 240	20,34	2
Para bandeja ancho 500	45 51 250	26,44	2
Para bandeja ancho 600	45 51 260	31,66	2

■ También disponible en acabados **inoxidable** y **galvanizado en caliente**. Consultar disponibilidad.

Dimensiones (mm)			Carga (Kg)
A	B	C	
162	200	55	523
212	200	55	364,6
262	200	55	304
362	200	55	238
462	200	55	200
562	200	55	147
662	200	55	131,5

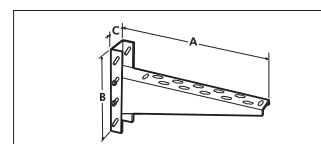

CONJUNTO SOPORTE ORIENTABLE "FR"



45 51 5XX

Conjunto	SENDZIMIR		
	Ref.	P.V.R. €/ud	U.Emb.
Para bandeja ancho 100	45 51 510	17,06	2
Para bandeja ancho 150	45 51 515	18,96	2
Para bandeja ancho 200	45 51 520	20,56	2
Para bandeja ancho 300	45 51 530	28,06	2
Para bandeja ancho 400	45 51 540	32,51	2
Para bandeja ancho 500	45 51 550	38,11	2
Para bandeja ancho 600	45 51 560	42,12	2

■ También disponible en acabados **inoxidable**. Consultar disponibilidad.

Dimensiones (mm)		
A	B	C
162	140	55
212	140	55
262	140	55
362	140	55
462	140	55
562	140	55
662	140	55

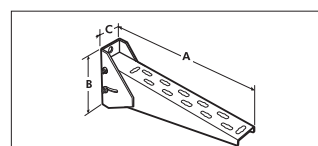

SOPORTE OMEGA SUSPENSIÓN "FR"



45 50 4XX

Soporte	SENDZIMIR		
	Ref.	P.V.R. €/ud	U.Emb.
Para bandeja ancho 100	45 50 410	11,65	4
Para bandeja ancho 150	45 50 415	12,51	4
Para bandeja ancho 200	45 50 420	13,26	4
Para bandeja ancho 300	45 50 430	15,23	4

(1) Refuerzo antiplastamiento. Se suministra junto con el soporte vertical-suspensión "FR".

Dimensiones (mm)					Carga (kg)
A	B	C	D	E	
153	196	50	23	131	264
204	196	50	23	131	154
252	196	50	23	131	106,8
357	196	50	23	131	84,8

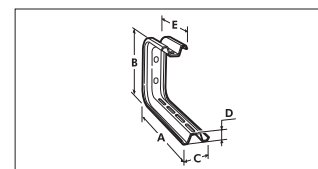

SOPORTE VERTICAL-SUSPENSIÓN "FR"



45 51 3XX

Soporte	SENDZIMIR		GALVANIZADO CALIENTE		INOXIDABLE		U.Emb.
	Ref.	P.V.R. €/ud	Ref.	P.V.R. €/ud	Ref.	P.V.R. €/ud	
Para bandeja ancho 100	45 51 310	7,82	45 52 310	10,60	45 55 310	19,96	10
Para bandeja ancho 150	45 51 315	8,50	45 52 315	11,66	45 55 315	21,93	10
Para bandeja ancho 200	45 51 320	9,06	45 52 320	12,18	45 55 320	26,54	10
Para bandeja ancho 300	45 51 330	10,96	45 52 330	14,81	45 55 330	30,42	10
Para bandeja ancho 400	45 51 340	12,78	45 52 340	17,68	45 55 340	41,64	5
Para bandeja ancho 500	45 51 350	17,32	45 52 350	21,29	45 55 350	61,33	5
Para bandeja ancho 600	45 51 360	20,31	45 52 360	25,16	45 55 360	70,52	5

Dimensiones (mm)				Carga (Kg)
A	B	C	D	
50	150	185	38	121,7
50	200	235	38	79,2
50	250	285	38	177
50	350	385	38	112
50	450	485	38	70,7
50	550	585	38	50
50	650	685	38	29,9

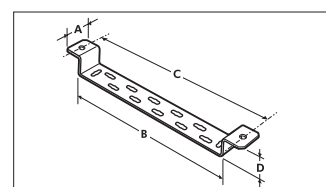

SOPORTE SUSPENSIÓN REFORZADO



45 51 6XX

Soporte

Ref.	SENDZIMIR	
	P.V.R. €/ud	U.Emb.
45 51 620	11,12	4
45 51 630	12,02	4
45 51 640	15,06	4
45 51 650	19,43	4
45 51 660	21,74	4

■ Soporte reversible para uso vertical cambiando la posición de las patas.

Dimensiones (mm)				Carga (kg)
A	B	C	D	
41,75	267,5	240	60	522,8
41,75	347,5	320	60	531
41,75	467,5	440	60	350
41,75	547,5	520	60	273,8
41,75	667,5	640	60	233,5

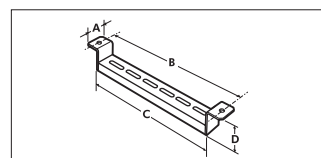

GRAPA TORNILLO VIGA



45 71 4XX

Grapa

Ref.	ZINCADO	
	P.V.R. €/ud	U.Emb.
45 71 408	17,80	10
45 71 410	17,80	10

■ Para suspensión a viga de elementos utilizando varilla roscada.
■ Material: acero zincado.

Dimensiones (mm)								Carga (Kg)	Cap. máx. de viga (mm)
A	B	C	D	E	F	H			
36	38	18	12,8	Ø9	M8	19	120	10	
41,5	44,5	21	17	Ø11	M10	20	250	10	

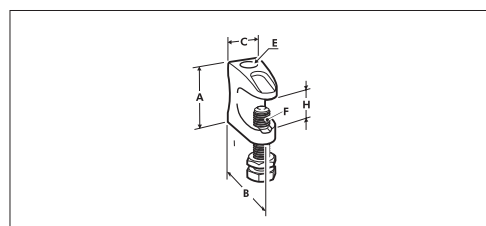

GRAPA HORIZONTAL DE SUSPENSIÓN



45 71 41X

Grapa horizontal

Ref.	FOSFATADO-ZN		
	P.V.R. €/ud	U.Emb.	
45 71 416	3,98	20	
45 71 418	3,83	20	

■ Material: acero con acabado superficial anticorrosivo.

Dimensiones (mm)						Carga (Kg)	Cap. máx. de viga (mm)
A	B	C	D	E	F		
5	21	46	6	19	40	70	4-10
50	21	46	8	19	40	70	4-10

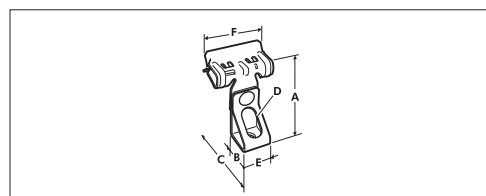

GRAPA VERTICAL DE SUSPENSIÓN



45 71 43X

Grapa vertical

Ref.	FOSFATADO-ZN		U.Emb.
	P.V.R. €/ud		
45 71 436	4,76		20
45 71 438	4,40		20

■ Material: acero con acabado superficial anticorrosivo.

Dimensiones (mm)					Carga (Kg)	Cap. máx. de viga (mm)
A	B	C	D	E		
92	21	33	6	19	70	4-10
92	21	33	8	19	70	4-10

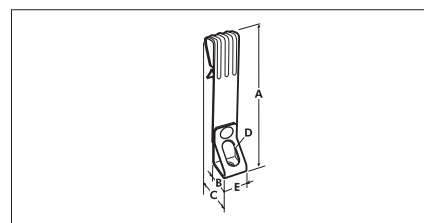

TORNILLOS FIJACIÓN



47 21 912

Tornillo	ZINCADO		BICROMATADO		INOXIDABLE		U.Emb.
	Ref.	P.V.R. €/ud	Ref.	P.V.R. €/ud	Ref.	P.V.R. €/ud	
M6x12	47 21 912	0,39	-	-	47 25 912	1,31	50
M6x20	45 71 110	0,44	45 76 110	0,38	45 75 110	1,41	50
M8x20	-	-	-	-	43 26 605	1,29	50

Dimensiones (mm)		Apriete (N.m)
A	B	
13,5	23,5	12
13,5	23,5	12
13,5	23,5	12

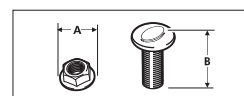

PERFILES TROQUELADOS



25 11 XXX

Perfil	SENDZIMIR		ZINCADO		U.Emb.
	Ref.	P.V.R. €/m	Ref.	P.V.R. €/m	
PR-1827	25 11 178	4,92	-	-	20
PR-1834	25 11 179	5,45	-	-	20
PR-2010	25 11 194	2,88	25 11 190	2,98	40
PR-2020	-	-	25 11 206	6,31	20
PR-2040	25 11 204	5,85	25 11 220	6,63	20
PR-2141 reforzado*	25 11 230	14,42	-	-	8
PR-4141 reforzado*	25 11 231	20,19	-	-	4
PRO reforzado**	25 11 240	21,19	-	-	4

■ Longitud: 2 m.
* Reforzados galvanizado sendzimir. Perfil PR.
** Reforzados galvanizado. Perfil PRO.



Perfil PR



Perfil PRO

Dimensiones (mm)				
A	B	C	D	E
18	27	7,5	-	1,2
18	34	8,5	-	1,5
10	20	4,5	-	1
20	20	6,5	-	1,5
20	40	7,5	-	1,5
21	41	9,5	7	2,5
41	41	,5	7	2,5
23	50	-	-	1,8

PR-18XX / PR-20X0

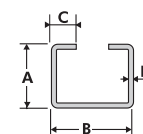

PR-2141 / PR-4141

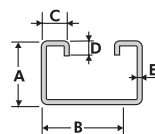

TUERCAS REFORZADAS Y CON MUELLE



25 21 7XX

Tuercas reforzadas con muelle	Ref.	P.V.R. €/ud	U.Emb.
Tuercas reforzada para M6	25 21 706	1,09	10
Tuercas reforzada para M8	25 21 708	1,14	10
Tuercas reforzada para M10	25 21 710	1,19	10
Tuercas c/muelle corto para M6	25 21 716	1,14	10
Tuercas c/muelle corto para M8	25 21 718	1,19	10
Tuercas c/muelle corto para M10	25 21 720	1,24	10
Tuercas c/muelle largo para M6	25 21 726	1,19	10
Tuercas c/muelle largo para M8	25 21 728	1,24	10
Tuercas c/muelle largo para M10	25 21 730	1,29	10

■ Para perfiles 2141 y 4141.

Dimensiones (mm)

A	B	C	D
-	-	- 6	M6
-	-	- 6	M8
-	-	- 8	M10
17	11	3 6	M6
17	11	3 6	M8
24	16	4 8	M10
37	31	6 6	M6
37	31	6 6	M8
37,5	29,5	7,5 8	M10

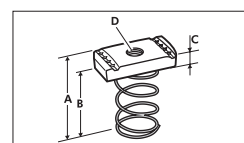

TUERCAS CUADRADAS



15 06 1XX

Tuercas cuadradas	Ref.	P.V.R. €/ud	U.Emb.
TM-4 para perfil 2020	15 06 110	18,53	100
TM-5 para perfil 2010 y 2020	15 06 120	20,59	100
TM-6 para perfil 2020 y 2010	15 06 130	21,62	100
TME-6 para perfil 2040	15 06 150	25,75	100
TME-8 para perfil 2040	15 06 155	67,92	100

Dimensiones (mm)

A	B	C	D
15	13	3	M4
18,8	16,8	3	M5
18,8	16,8	3	M6
36	20	5	M6
36	20	5	M8

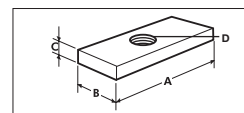

ÍNDICE DE REFERENCIAS

REF.	P.V.R EUROS	UNID EMB.	CLAVE REF.	PAG.
4772220	a consultar	1	C	
4772230	a consultar	1	C	
4772306	75,57	1	C	24
4772310	77,05	1	C	24
4772315	87,92	1	C	24
4772320	105,44	1	C	24
4772330	145,27	1	C	24
4772340	193,30	1	C	24
4772350	229,68	1	C	24
4772360	255,56	1	C	24
4772410	85,49	1	C	24
4772415	97,87	1	C	24
4772420	117,83	1	C	24
4772430	184,05	1	C	24
4772440	225,06	1	C	24
4772450	290,23	1	C	24
4772460	310,51	1	C	24
4772706	49,85	1	C	24
4772710	56,45	1	C	24
4772715	65,16	1	C	24
4772720	70,82	1	C	24
4772730	87,62	1	C	24
4772740	120,92	1	C	24
4772750	161,03	1	C	24
4772760	166,93	1	C	24
4781520	23,68	1	C	25
4781521	26,84	1	C	25
4781525	25,26	1	B	25
4781526	28,41	1	B	25
4781530	26,84	1	C	25
4781531	29,98	1	B	25
4781930	4,73	1	C	25
4781931	6,18	1	C	25
4781932	7,28	1	C	25
4781933	8,65	1	C	25
4781950	3,95	1	C	25
4781960	5,05	1	B	25
4781961	6,50	1	B	25
4781962	7,59	1	B	25
4781963	8,86	1	B	25
4781964	9,61	1	C	25
4781965	10,90	1	C	25
4781966	11,53	1	C	25
4781980	5,99	1	C	25
4781981	7,28	1	C	25
4781982	8,55	1	B	25
4781983	9,61	1	C	25
4781984	10,26	1	C	25
4781985	11,08	1	C	25
4781986	11,85	1	C	25
4782520	a consultar	1	C	
4782521	a consultar	1	C	
4782525	43,59	1	C	25
4782526	49,00	1	C	25
4782530	46,28	1	C	25
4782531	51,70	1	C	25
4782930	a consultar	1	C	
4782931	a consultar	1	C	
4782932	a consultar	1	C	
4782933	a consultar	1	C	
4782950	6,82	1	C	25
4782960	8,72	1	C	25
4782961	11,18	1	C	25
4782962	13,11	1	C	25
4782963	15,26	1	C	25
4782964	16,62	1	C	25
4782965	18,79	1	C	25
4782966	19,87	1	C	25
4782980	10,36	1	C	25
4782981	12,56	1	C	25
4782982	14,71	1	C	25
4782983	16,62	1	C	25
4782984	17,71	1	C	25
4782985	19,06	1	C	25
4782986	20,41	1	C	25

(*) Precio por unidad de embalaje.

DIRECCION REGIONAL NORDESTE

Delegación:
BARCELONA

Sicilia, 91-97 · 6°
08013 BARCELONA
Tel.: 93 484 31 01 · Fax: 93 484 30 82
E-mail: del.barcelona@es.schneider-electric.com

Delegaciones:

BALEARES

Gremi de Teixidors, 35 · 2°
07009 PALMA DE MALLORCA
Tel.: 971 43 68 92 · Fax: 971 43 14 43

GIRONA

Pl. Josep Pla, 4 · 1° 1°
17001 GIRONA
Tel.: 972 22 70 65 · Fax: 972 22 69 15

LLEIDA

Prat de la Riba, 18
25004 LLEIDA
Tel.: 973 22 14 72 · Fax: 973 23 50 46

TARRAGONA

Carles Riba, 4
43007 TARRAGONA
Tel.: 977 29 15 45 · Fax: 977 19 53 05

DIRECCION REGIONAL NOROESTE

Delegación:
A CORUÑA

Pol. Ind. Pocomaco, Parcela D · 33 A
15190 A CORUÑA
Tel.: 981 17 52 20 · Fax: 981 28 02 42
E-mail: del.coruna@es.schneider-electric.com

Delegaciones:

ASTURIAS

Parque Tecnológico de Asturias
Edif. Centroelena, parcela 46 · Oficina 1° F
33428 LLANERA (Asturias)
Tel.: 98 526 90 30 · Fax: 98 526 75 23
E-mail: del.oviedo@es.schneider-electric.com

GALICIA SUR-VIGO

Ctra. Vella de Madrid, 33, bajos
36214 VIGO
Tel.: 986 27 10 17 · Fax: 986 27 70 64
E-mail: del.vigo@es.schneider-electric.com

LEON

Moisés de León · Bloque 43, bajos
24006 LEON
Tel.: 987 21 88 61 · Fax: 987 21 88 49
E-mail: del.leon@es.schneider-electric.com

DIRECCION REGIONAL NORTE

Delegación:
VIZCAYA

Estarteibe, 5 · 4°
48940 LEIOA (Vizcaya)
Tel.: 94 480 46 85 · Fax: 94 480 29 90
E-mail: del.bilbao@es.schneider-electric.com

Delegaciones:

ALAVA

Portal de Gamarra, 1
Edificio Deba · Oficina 210
01013 VITORIA-GASTEIZ
Tel.: 945 123 758 · Fax: 945 257 039

CANTABRIA

Sainz y Trevilla, 62 bajos
Pol. Ind. de Guarnizo
39611 ASTILLERO (Santander)
Tel.: 942 54 60 68 · Fax: 942 54 60 46

GUIPUZCOA

Parque Empresarial Zuatzu
Edificio Urumea, planta baja · Local 5
20018 DONOSTIA - SAN SEBASTIAN
Tel.: 943 31 39 90 · Fax: 943 21 78 19
E-mail: del.donosti@es.schneider-electric.com

NAVARRA

Parque Empresarial La Muga, 6 · Planta 4, oficina 1
31160 ORCOYEN (Navarra)
Tel.: 948 29 96 20 · Fax: 948 29 96 25

DIRECCION REGIONAL CASTILLA-ARAGON-RIOJA

Delegación:
CASTILLA-BURGOS

Pol. Ind. Gamonal Villimar
30 de Enero de 1964, s/n · 2°
09007 BURGOS
Tel.: 947 47 44 25 · Fax: 947 47 09 72
E-mail: del.burgos@es.schneider-electric.com

Delegaciones:

ARAGON-ZARAGOZA

Pol. Ind. Argualas, nave 34
50012 ZARAGOZA
Tel.: 976 35 76 61 · Fax: 976 56 77 02
E-mail: del.zaragoza@es.schneider-electric.com

CENTRO/NORTE-VALLADOLID

Topacio, 60 · 2°
Pol. Ind. San Cristóbal
47012 VALLADOLID
Tel.: 983 21 46 46 · Fax: 983 21 46 75
E-mail: del.valladolid@es.schneider-electric.com

LA RIOJA

Avda. Pio XII, 14 · 11° F
26003 LOGROÑO
Tel.: 941 25 70 19 · Fax: 941 27 09 38

DIRECCION REGIONAL CENTRO

Delegación:
MADRID

Ctra. de Andalucía, km. 13
Pol. Ind. Los Angeles
28906 GETAFE (Madrid)
Tel.: 91 624 55 00 · Fax: 91 682 40 48
E-mail: del.madrid@es.schneider-electric.com

Delegaciones:

GUADALAJARA-CUENCA

Tel.: 91 624 55 00 · Fax: 91 682 40 47

TOLEDO

Tel.: 91 624 55 00 · Fax: 91 682 40 47

DIRECCION REGIONAL LEVANTE

Delegación:
VALENCIA

Font Santa, 4 · Local D
46910 ALFAFAR (Valencia)
Tel.: 96 318 66 00 · Fax: 96 318 66 01
E-mail: del.valencia@es.schneider-electric.com

Delegaciones:

ALBACETE

Paseo de la Cuba, 21 · 1° A
02005 ALBACETE
Tel.: 967 24 05 95 · Fax: 967 24 06 49

ALICANTE

Monegros, s/n · Edificio A-7 · 1°, locales 1-7
03006 ALICANTE
Tel.: 965 10 83 35 · Fax: 965 11 15 41
E-mail: del.alicante@es.schneider-electric.com

CASTELLON

República Argentina, 12, bajos
12006 CASTELLON
Tel.: 964 24 30 15 · Fax: 964 24 26 17

MURCIA

Senda de Enmedio, 12, bajos
30009 MURCIA
Tel.: 968 28 14 61 · Fax: 968 28 14 80
E-mail: del.murcia@es.schneider-electric.com

DIRECCION REGIONAL SUR

Delegación:
SEVILLA

Avda. de la Innovación, s/n
Edificio Arena 2 · 2°
41020 SEVILLA
Tel.: 95 499 92 10 · Fax: 95 425 45 20
E-mail: del.sevilla@es.schneider-electric.com

Delegaciones:

ALMERÍA

Calle Lentisco s/n · Edif. Celulosa III
Oficina 6 · Local 1
Pol. Ind. La Celulosa
04007 ALMERIA
Tel.: 950 15 18 56 · Fax: 950 15 18 52

CADIZ

Polar, 1 · 4° E
11405 JEREZ DE LA FRONTERA (Cádiz)
Tel.: 956 31 77 68 · Fax: 956 30 02 29

CORDOBA

Arte, 16, bajos
14011 CORDOBA
Tel.: 957 23 20 56 · Fax: 957 45 67 57

GRANADA

Baza, s/n · Edificio ICR
Pol. Ind. Juncaril
18220 ALBOLOTE (Granada)
Tel.: 958 46 76 99 · Fax: 958 46 84 36

HUELVA

Tel.: 954 99 92 10 · Fax: 959 15 17 57

JAEN

Paseo de la Estación, 60
Edificio Europa · 1° A
23007 JAEN
Tel.: 953 25 55 68 · Fax: 953 26 45 75

MALAGA

Parque Industrial Trevenez
Escritora Carmen Martín Gaité, 2 · 1°, local 4
29196 MALAGA
Tel.: 95 217 92 00 · Fax: 95 217 84 77

EXTREMADURA-BADAJOS

Avda. Luis Movilla, 2 · Local B
06011 BADAJOZ
Tel.: 924 22 45 13 · Fax: 924 22 47 98

EXTREMADURA-CACERES

Avda. de Alemania
Edificio Descubrimiento · Local T2
10001 CACERES
Tel.: 927 21 33 13 · Fax: 927 21 33 13

CANARIAS-LAS PALMAS

Ctra. del Cardón, 95-97 · Locales 2 y 3
Edificio Jardines de Galicia
35010 LAS PALMAS DE G.C.
Tel.: 928 47 26 80 · Fax: 928 47 26 91
E-mail: del.canarias@es.schneider-electric.com

CANARIAS-TENERIFE

Custodios, 6 · 2° · El Cardonal
38108 LA LAGUNA (Tenerife)
Tel.: 922 62 50 50 · Fax: 922 62 50 60

INSTITUTO SCHNEIDER ELECTRIC DE FORMACIÓN

Bac de Roda, 52, Edificio A, planta 1
08019 BARCELONA
Tel.: 93 433 70 03 · Fax: 93 433 70 39
www.isefonline.es

SOPORTE Y SERVICIO TÉCNICO A CLIENTES 902 10 18 13

En razón de la evolución de las normativas y del material, las características indicadas por el texto y las imágenes de este documento no nos comprometen hasta después de una confirmación por parte de nuestros servicios.

Los precios de las tarifas pueden sufrir variación y, por tanto, el material será siempre facturado a los precios y condiciones vigentes en el momento del suministro.

Schneider Electric España, S.A.

Bac de Roda, 52, edificio A · 08019 Barcelona · Tel.: 93 484 31 00 · Fax: 93 484 33 07 · <http://www.schneiderelectric.es>

350605G08

miembro de:



El Portal de la Instalación Eléctrica